



Industrial Computer Products  
Data Acquisition Systems

# ET-7X00/PET-7X00 Series User Manual



ET-7000/ET-7200 Series  
(Ethernet I/O)



PET-7000/PET-7200 Series  
(PoE I/O)

## Warranty

---

All products manufactured by ICP DAS are under warranty regarding defective materials for a period of one year, beginning from the date of delivery to the original purchaser.

## Warning

---

ICP DAS assumes no liability for any damage resulting from the use of this product. ICP DAS reserves the right to change this manual at any time without notice. The information furnished by ICP DAS is believed to be accurate and reliable. However, no responsibility is assumed by ICP DAS for its use, nor for any infringements of patents or other rights of third parties resulting from its use.

## Copyright

---

Copyright © 2014 by ICP DAS CO., LTD. All rights are reserved.

## Trademarks

---

Names are used for identification purpose only and may be registered trademarks of their respective companies.

## Contact US

If you have any problems, please feel free to contact us.

You can count on us for a quick response.

Email: [service@icpdas.com](mailto:service@icpdas.com)

# Table of Contents

<b>1. Introduction .....</b>	<b>1</b>
1.1. Features .....	3
1.2. Overview .....	6
1.3. Dimensions .....	10
1.4. Companion CD .....	12
<b>2. Getting Started .....</b>	<b>13</b>
2.1. Mounting the ET-7X00/PET-7X00 .....	14
2.2. Configuring the Boot Mode .....	16
2.3. ET-7X00/PET-7X00 Hardware Connections .....	17
2.4. Installing the MiniOS7 Utility .....	19
2.5. Using the MiniOS7 Utility to Assign an IP Address .....	20
2.6. Enabling the Adobe Flash Player in Your Browser .....	24
2.7. Configuring the I/O Functions .....	25
<b>3. Web Applications .....</b>	<b>28</b>
3.1. Overview .....	31
3.2. Configuration .....	33
3.2.1. Network Settings .....	34
3.2.2. Basic Settings .....	37
3.2.3. Module I/O Settings .....	48
3.3. Authentication .....	57
3.3.1. Account Management .....	58
3.3.2. Accessible IP Settings .....	61
3.4. Web HMI .....	65
3.4.1. Web HMI .....	66
3.4.2. Web Edit .....	67
3.5. I/O Pair Connection .....	76

3.5.1. Example 1: Pair Connection - AO to AI.....	78
3.5.2. Example 2: Pair Connection - DO to DI .....	83
3.6. More Information .....	86
<b>4. Modbus and Modbus TCP/IP .....</b>	<b>88</b>
4.1. Modbus TCP/IP Interface.....	89
4.2. Protocol Description .....	90
4.3. Data Encoding.....	93
4.3.1. Binary .....	93
4.3.2. 16-bits Word.....	93
4.4. Data Model .....	94
4.5. Modbus Functions and Registers .....	95
4.5.1. 01 (0x01) Read Coils.....	95
4.5.2. 02 (0x02) Read Discrete Inputs .....	96
4.5.3. 03 (0x03) Read Holding Registers .....	97
4.5.4. 04 (0x04) Read Inputs Registers.....	98
4.5.5. 05 (0x05) Write Single Coil.....	99
4.5.6. 06 (0x06) Write Single Register.....	100
4.5.7. 15 (0x0F) Write Multiple Coils .....	101
4.5.8. 16 (0x10) Write Multiple Registers .....	102
4.6. Modbus Master Simulators .....	103
4.6.1. Modbus/TCP Client .....	103
4.6.2. Modbus Master Tool .....	105
4.7. Modbus Demo Programs.....	108
<b>5. Calibration .....</b>	<b>109</b>
5.1. Voltage and Current Calibration .....	109
5.2. Thermocouple Calibration.....	114
5.3. RTD Calibration .....	115
5.4. Recover Calibration to Factory Setting .....	117
<b>6. MiniOS7 Utility Tools.....</b>	<b>118</b>

6.1. Establishing a Connection.....	118
6.2. Exchanging the Protocol (TCP/IP to UDP).....	121
6.3. Updating the ET-7X00/PET-7X00 OS.....	123
6.4. Updating the ET-7X00/PET-7X00 Firmware.....	127
<b>7. External Tools and Tasks .....</b>	<b>132</b>
7.1. LabVIEW.....	132
7.2. OPC Server .....	133
7.3. SCADA .....	134
7.3.1. InduSoft.....	135
7.3.2. Citect .....	136
7.3.3. iFix.....	137
<b>Appendix A. Node Information Area.....</b>	<b>138</b>
<b>Appendix B. Thermocouple .....</b>	<b>139</b>
<b>Appendix C. Modbus Application Notes .....</b>	<b>140</b>
C.1. Dual Watchdog.....	140
C.2. Power-on Value .....	141
C.3. Safe Value .....	143
C.4. AI High/Low Alarm .....	145
C.5. AI High/Low Latch .....	150
<b>Appendix D. Analog Input Type and Data Format Table .....</b>	<b>151</b>
<b>Appendix E. Analog Output Type and Data Format Table .....</b>	<b>156</b>
<b>Appendix F. Network Address Translation.....</b>	<b>157</b>
<b>Appendix G. Troubleshooting .....</b>	<b>159</b>
<b>Appendix H. Revision History .....</b>	<b>160</b>

# 1. Introduction

The ET-7X00/PET-7X00, a web-based Ethernet I/O module, features a Built-in web server which allows configuration, I/O monitoring and I/O control by simply using a regular web browser. Remote control is as easy as surfing the Internet.

Besides Web HMI function, no more programming or HTML skills are required; creating dynamic and attractive web pages for I/O monitoring and I/O control would be fun to engineers ever after. The ET-7X00/PET-7X00 offers easy and safe access for users from anytime and anywhere! In addition, the ET-7X00/PET-7X00 also supports Modbus TCP protocol that makes perfect integration to SCADA software.



Furthermore, PET-7X00 features “PoE” that not only Ethernet but also power is carried through an Ethernet cable. This feature makes installation of PET-7X00 a piece of cake. Imagine that no more unnecessary wires, only an Ethernet cable takes care of everything in the field.

## Comparison between ET-7X00 and PET-7X00

The PET-7X00 has some unique features that different from the ET-7X00

### ► PET-7X00 = Power over Ethernet + ET-7X00

The PET-7X00 includes integrated Power over Ethernet (PoE) technology that allows both power and data to be carried over a single Ethernet cable, meaning that a device can operate solely from the power it receives through the data cable. This innovation allows greater flexibility in office design, higher efficiency in systems design, and faster turnaround time in installation and implementation. The PET-7X00 features true IEEE 802.3af-compliant (classification, Class 1) PoE using both Ethernet pairs (Category 5 Ethernet cable). The PET-7X00 can also receive power from auxiliary power sources such as DC adapters and external battery packs, in addition to the PoE-enabled network. This is a desirable feature when the total system power requirements exceed the PoE's load capacity. Furthermore, with the benefit of the auxiliary power option, the PET-7X00 can be easily integrated into a standard Ethernet (non-PoE) system.

### ► Industrial PoE Solution

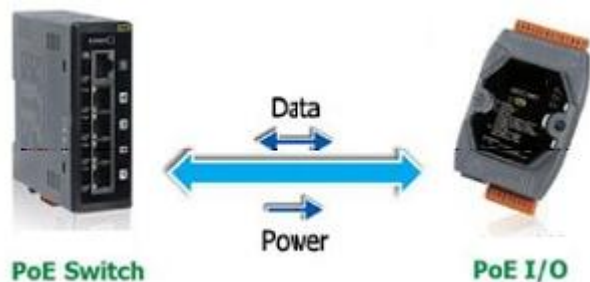

The PoE switch is the ideal power source when using the PET-7X00 module. The PoE switch automatically detects whether the connected devices are PoE-enabled or not, which ensures that the PoE switch will function in conjunction with both PoE and non-PoE devices simultaneously.

### ► More information about the PET-7X00 series

There are two ways for PET-7X00 series devices to obtain power. The first is through the Ethernet via a PoE switch; the second one is the usual method through wiring from an external power source. External power source should range from +12 V<sub>DC</sub> to 48 V<sub>DC</sub>. The reason that the second method has been retained is because it might still prove useful for different applications in a variety of scenarios. The PET-7X00 is also equipped with an LED to indicate whether or not the power is being supplied via a PoE Switch.

## 1.1. Features

The ET-7X00/PET-7X00 module offers the most comprehensive configuration focused on meeting specific application requirements. The following details the features designed to simplify installation, configuration and application.

### Power over Ethernet (PoE)

---

The PET-7X00/PET-7X00 series module can be powered by an IEEE802.3af compliant PoE switch. Both Ethernet and power can be carried by an Ethernet cable eliminating the need for additional wiring and power supply.



### Daisy-Chain Ethernet Cabling

---

The ET-7200/PET-7200 Series has a built-in two-port Ethernet switch to implement daisy-chain topology. The cabling is much easier and total costs of cable and switch are significantly reduced.



### LAN Bypass

---

LAN Bypass feature guarantees the Ethernet communication. It will automatically active to continue the network traffic when the ET-7200/PET-7200 loses its power.



## Communication Security

---

Account and password are needed when logging into the web server. An IP address filter is also included, which can be used to allow or deny connections with specific IP addresses.

## Support for both Modbus TCP and Modbus UDP Protocols

---

The Modbus TCP, Modbus UDP slave function on the Ethernet port can be used to provide data to remote SCADA software.

## Built-in I/O

---

Various I/O components are mixed with multiple channels in a single I/O module, which provides the most cost effective I/O usage and enhances performance of the I/O operations.

## Dual Watchdog

---

The Dual Watchdog is consists of a Module Watchdog and a Communication Watchdog. The action of AO, DO are also associated to the Dual Watchdog.

**Module Watchdog** is a built-in hardware circuit to monitor the operation of the module and will reset the CPU if a failure occurs in the hardware or the software. Then the Power-on Value of AO, DO will be loaded.

**Communication Watchdog** is a software function to monitor the communication between the host and the I/O module. The timeout of the communication Watchdog is programmable, when the I/O doesn't receive commands from the host for a while, the watchdog forces the AO, DO to pre-programmed Safe Value to prevent unpredictable damage of the connected devices.

## Highly Reliable Under Harsh Environment

---

Wide Operating Temperature Range: -25 ~ +75°C

Storage Temperature: -30 ~ +80°C

Humidity 10 ~ 90% RH (Non-condensing)



## I/O Pair Connection

This function is used to create a AI/DI to AO/DO pair through the Ethernet. Once the configuration is completed, the I/O module can poll the status of remote AI/DI devices and then use the Modbus TCP protocol to continuously write to a local AO/DO channels in the background.

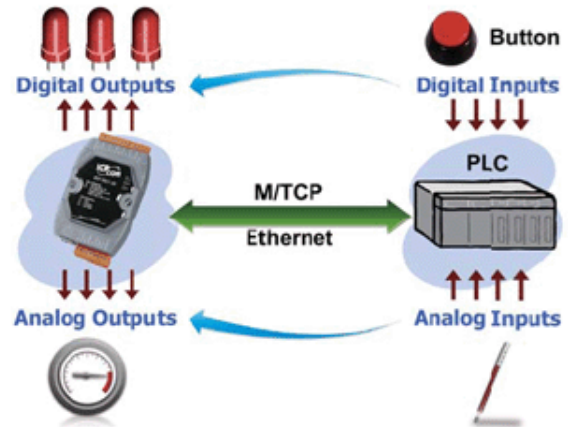

## Power-on Value and Safe Value

Besides setting by the set AO, DO commands, the AO, DO can be set under two other conditions.

**Power-on Value:** The Power-on Value is loaded into the AO, DO under 3 conditions: Power-on, reset by Module Watchdog, reset by reset command.

**Safe Value:** When the Communication Watchdog is enabled and a Communication Watchdog timeout occurs, the “safe value” is loaded into the AO, DO.

## LED indicators for DIO status

The LED indicators for DIO status are for ET-7200/PET-7200 series.

## Reset button

The reset button is for ET-7200/PET-7200 series. It is used to clear all data and restore all settings to be factory default values. It is very useful especially when you forget the ID, password to log into the web server, or IP address to access the Ethernet I/O module.

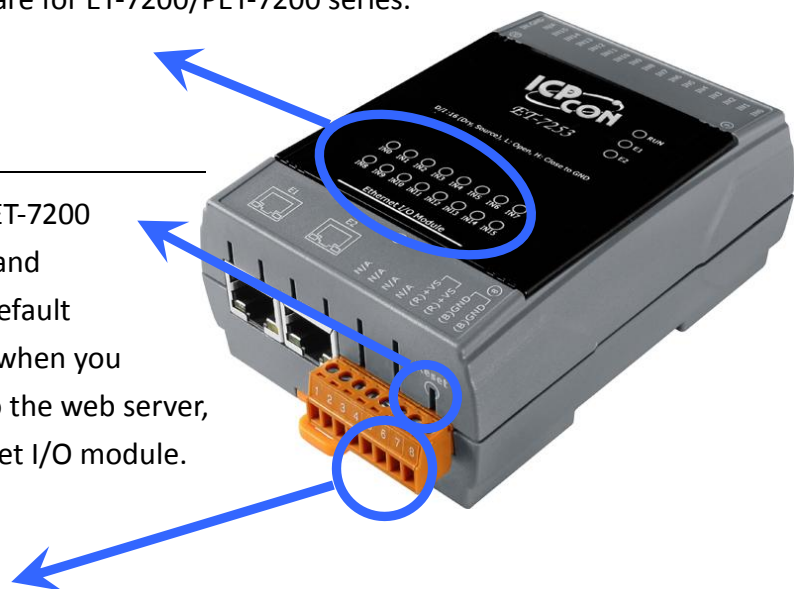

## Two pair of power input pins

For ET-7000/PET-7000 series, there are only two pins for power input. To ease the wiring, the pins are increased to four pins as two pairs for ET-7200/PET-7200 series.

## 1.2. Overview

The front panel of the ET-7X00/PET-7X00 module contains the Ethernet Port, connectors and LEDs.

Please refer to the data sheets for specific ET-7X00/PET-7X00 models for details of pin assignments, which can be found at:

[http://ftp.icpdas.com/pub/cd/6000cd/napdos/et7000\\_et7200/document/data\\_sheet/](http://ftp.icpdas.com/pub/cd/6000cd/napdos/et7000_et7200/document/data_sheet/)

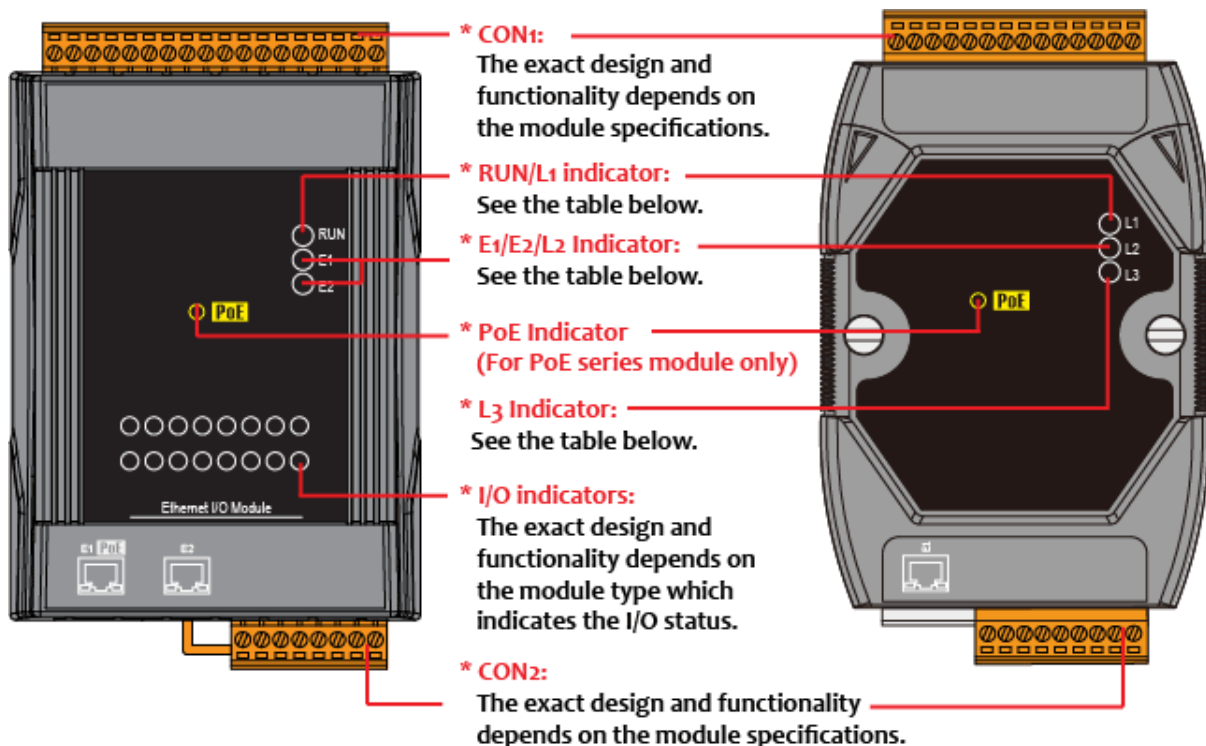

Model	Label	Status	Description
ET-7000/ PET-7000	L1	Flashing	The unit is turned on and is ready for use.
	L2	On	A link has been established on the E1 port.
		Off	No link is established on the E1 port.
		Flashing	Data transmission or receiving activity is occurring on the E1 port.
	L3	On	The E1 port is operating at 10 Mb/s.
		Off	The E1 port is operating at 100 Mb/s.
ET-7200/ PET-7200	RUN	Flashing	The unit is turned on and is ready for use.
	E1	On	A link has been established on the E1 port.
		Off	No link is established on the E1 port.
		Flashing	Data transmission or receiving activity is occurring on the E1 port.
	E2	On	A link has been established on the E2 port.
		Off	No link is established on the E2 port.
Flashing		Data transmission or receiving activity is occurring on the E2 port.	

The bottom panel of the ET-7X00/PET-7X00 module contains the Ethernet port and the reset button.

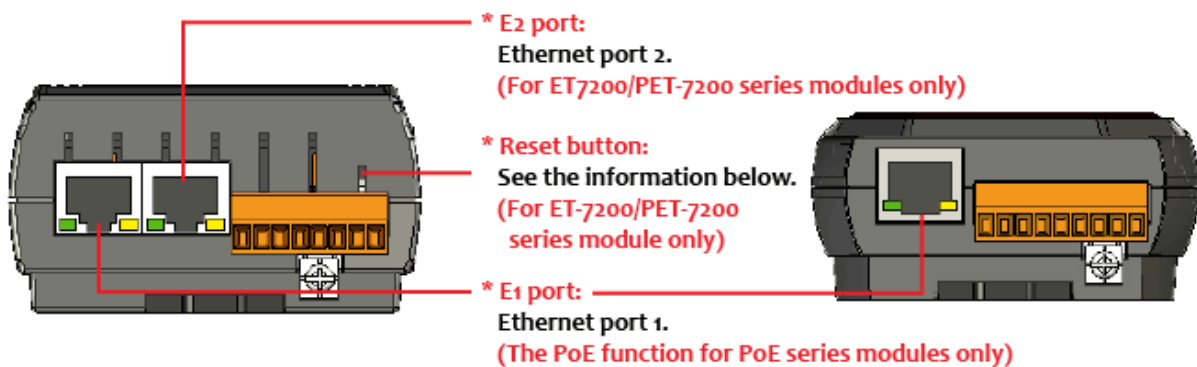

### **Reset button (for ET-7200/PET-7200 series modules only)**

---

The reset button is used to restore the following settings to its factory defaults by pressing and holding the reset button for 5 seconds.

- Network Settings
- Authentication
- Web HMI
- Pair Connection

For more information about these settings, please refer to section 3.2.2. (C) "Resetting All Settings to Default".

The back panel of the ET-7X00/PET-7X00 module contains the frame ground and the operating mode selector switch.

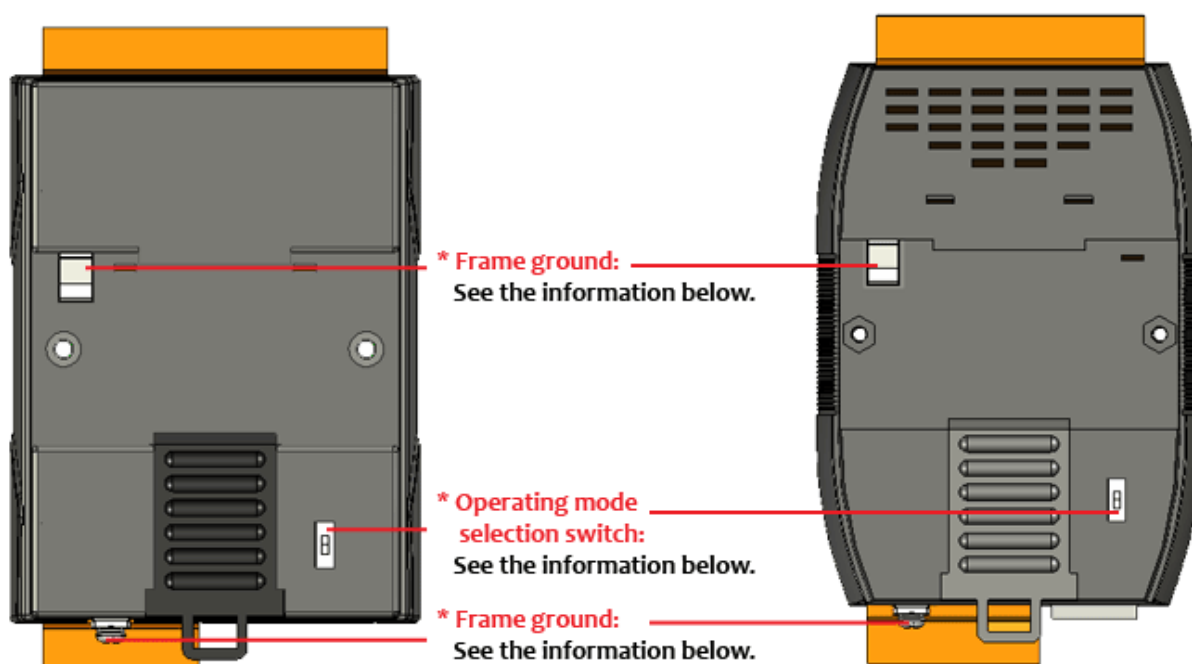

## Operating Mode Selector Switch

### **Init Mode:**

This mode is used for MiniOS7 configuration.

### **Normal Mode:**

This mode is used to execute and run firmware.

On the ET-7X00/PET-7X00 module, the operating mode selector switch should usually be in the Normal position. The switch should only be moved from the Normal position to the Init position when updating the ET-7X00/PET-7X00 firmware or the OS. Once the update has been completed, ensure that the switch is returned to the Normal position.

## Frame Ground

---

Electronic circuits are constantly vulnerable to Electrostatic Discharge (ESD), which becomes worse in a continental climate area. The ET-7X00/PET-7X00 series features a new design for the frame ground that provides a path for bypassing ESD, allowing enhanced static (ESD) protection capabilities and ensuring that the module is more reliable.

Choosing either of the following options will provide a better level of protection for the module:

The ET-7X00/PET-7X00 has a metallic board attached to the back of the plastic case, shown as “1” in the figure below.

When mounted to a DIN-Rail, connect the DIN-Rail to the earth ground because the DIN-Rail is in contact with the upper frame ground, as shown as “2” in the figure below.

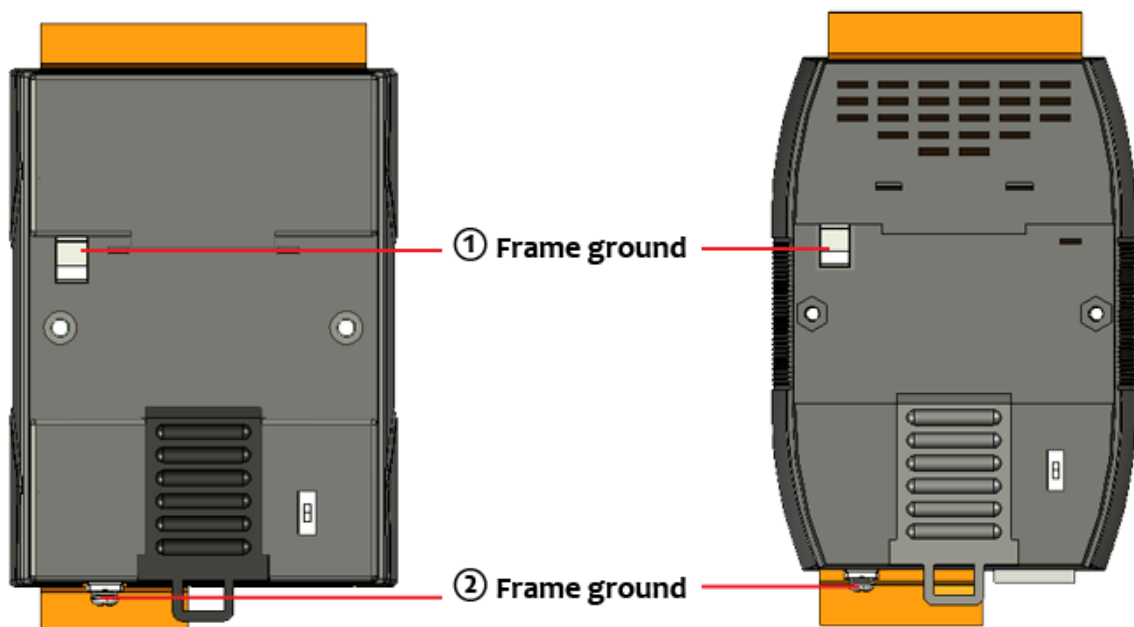

## 1.3. Dimensions

The following diagrams provide the dimensions of the ET-7X00/PET-7X00 module and can be used as a reference when defining the specifications for any custom enclosures. All dimensions are in millimeters.

**For the ET-7000, PET-7000: 72 x 123 x 35**

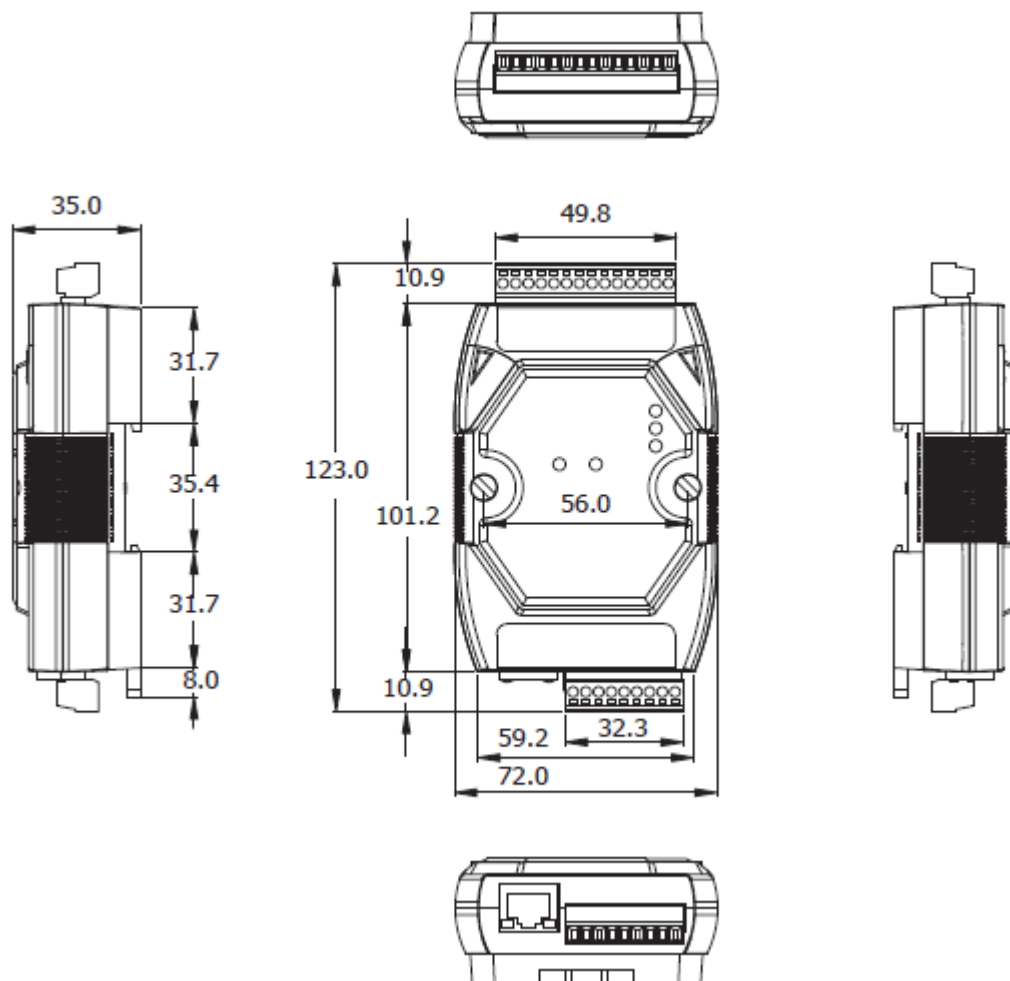

**For the ET-7200, PET-7200: 76 x 120 x 42**

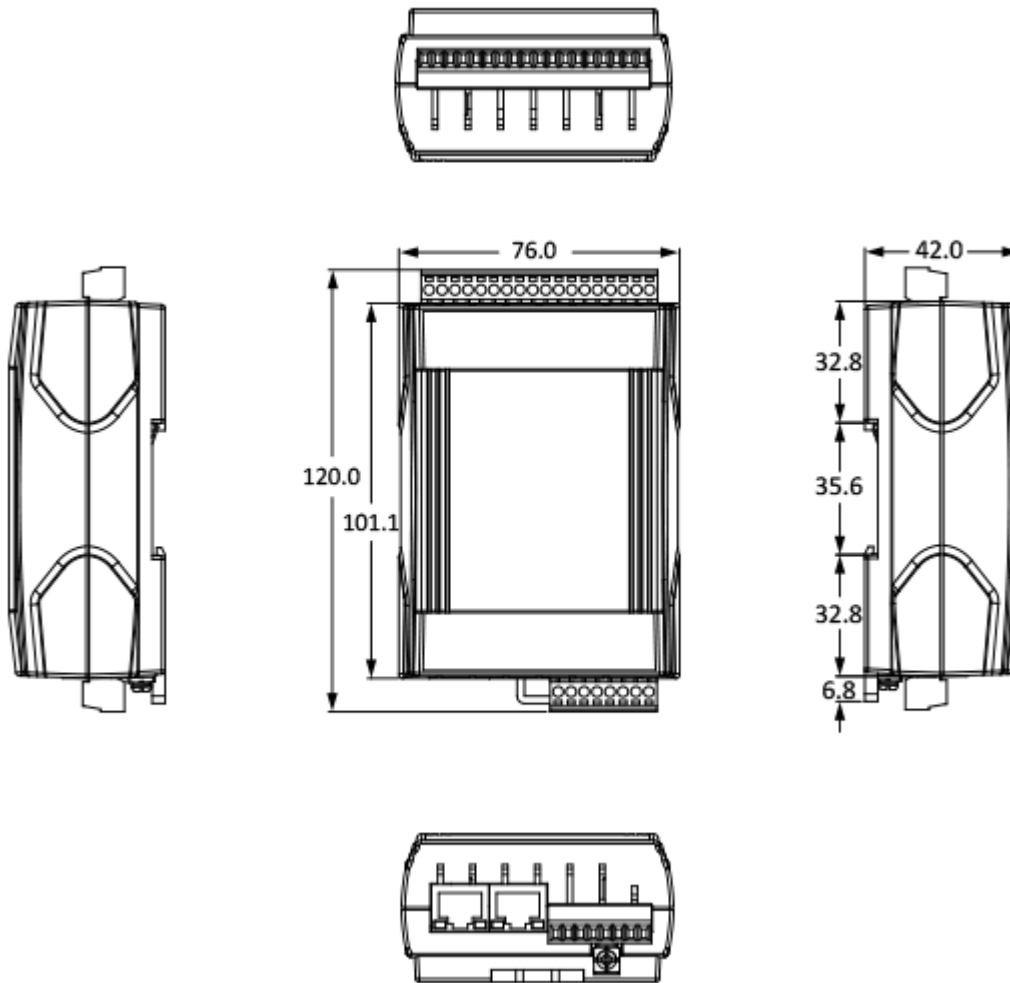



## 1.4. Companion CD

This package includes a companion CD that provides the drivers, a software utility, and all of the required documentation, etc. An outline of the directory structure for the files contained on the CD is shown below.

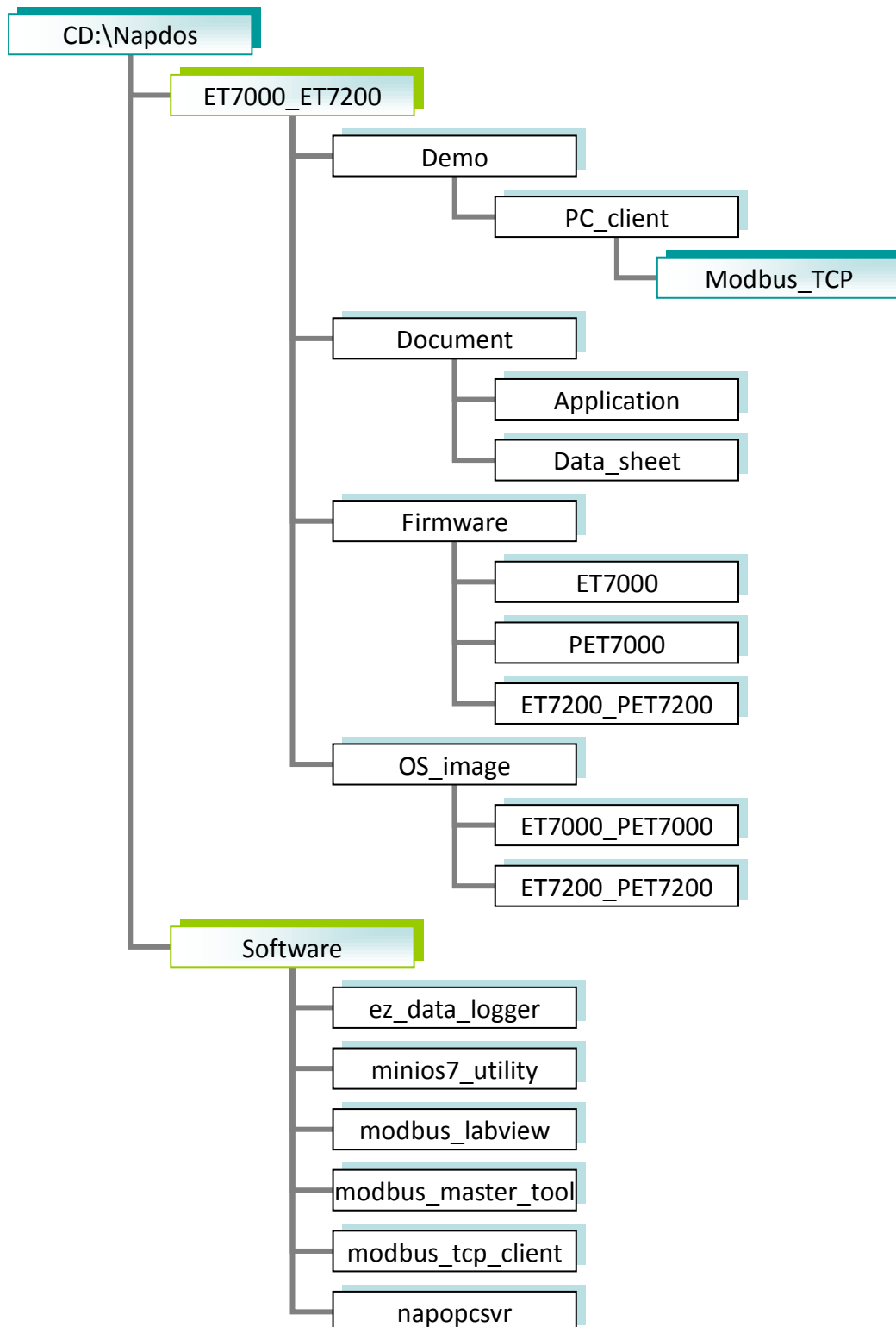

## 2. Getting Started

If you are a new user, begin with this chapter as it includes a guided tour that provides a basic overview of how to install, configure and use the ET-7X00/PET-7X00 module.

Before starting any task, please check the package contents. If any of the following items are either missing or damaged, contact your dealer or distributor.

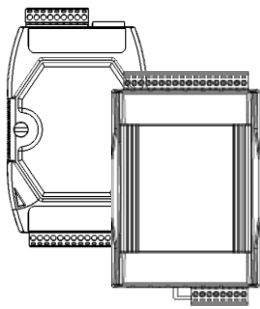

ET-7X00/PET-7X00

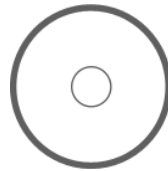

Software Utility CD

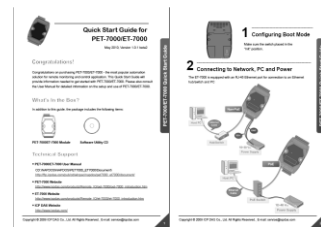

Quick Start Guide

Before operating the ET-7X00/PET-7X00 module, a basic understanding of the hardware specifications is required, such as the dimensions of the module, the usable input voltage range of the power supply, and the type of communication interfaces.

## 2.1. Mounting the ET-7X00/PET-7X00

The ET-7X00/PET-7X00 module can be mounted by attaching the bottom of the chassis to a DIN-Rail, to the wall, or by piggybacking it to another module.

### DIN-Rail Mounting

The ET-7X00/PET-7X00 module includes simple rail clips that can be used to reliably mount it on a standard 35 mm DIN-Rail.

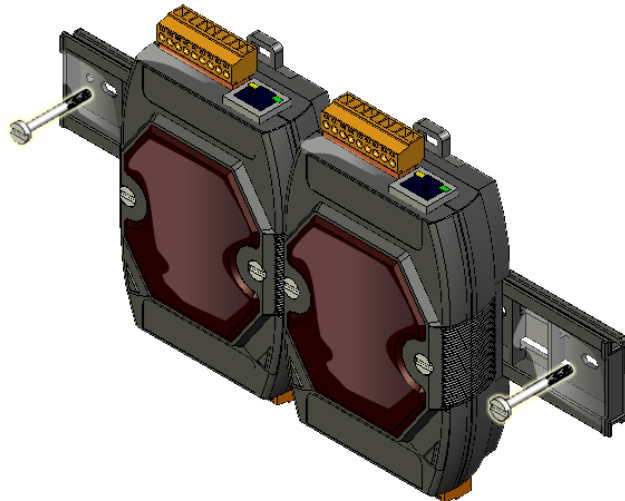

### Mounting the Chassis on a DIN-Rail

1. Hook the upper tab over the upper flange of the DIN-Rail.

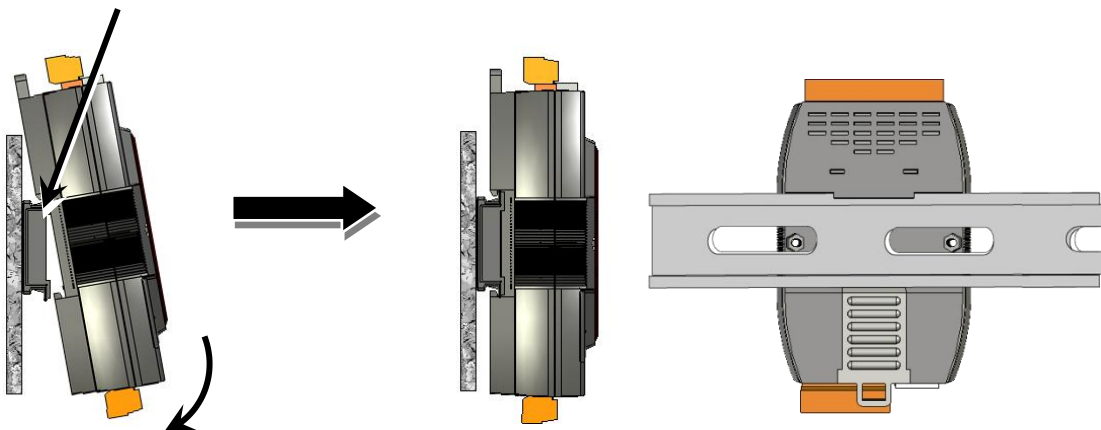

2. Tilt the module toward the DIN-Rail until it snaps securely to rail.

## **Piggyback Mounting**

---

The ET-7X00/PET-7X00 module has a hole on either side of the casing that can be used for piggyback mounting.

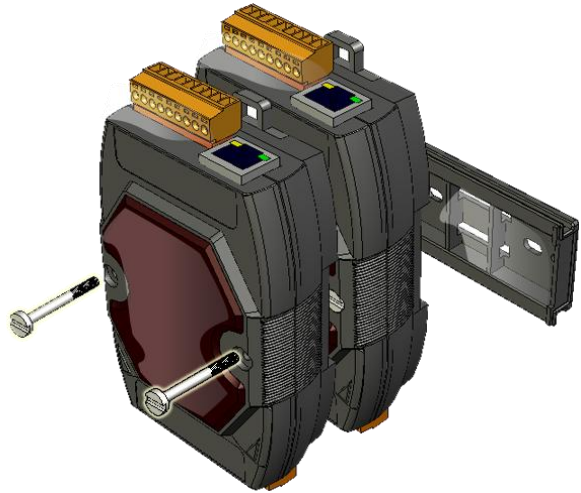

## 2.2. Configuring the Boot Mode

The ET-7X00/PET-7X00 module has two operating modes, which can be determined by the switch mechanism on the chassis.

### Init Mode

---

Init mode is a way to use MiniOS7 configuration mode.

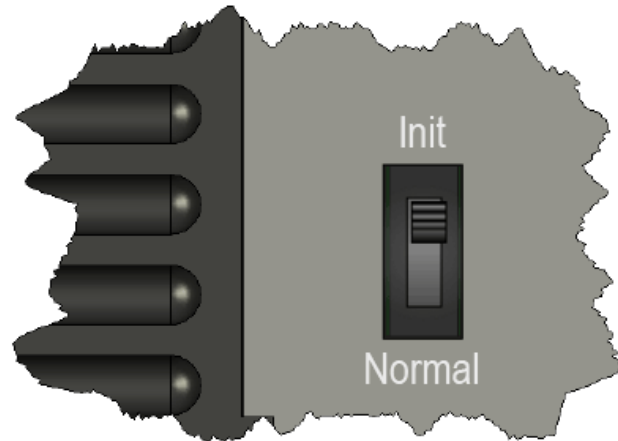

### Tips & Warnings

---



Init mode is a method to use MiniOS7 configuration mode and update the software. After the update is completed, set the switch to the Normal position.

---

### Normal Mode

---

Normal mode is the default mode of operation and the one you will use most of the time. Use this mode for more tasks and configurations. Programs also are executed in this mode.

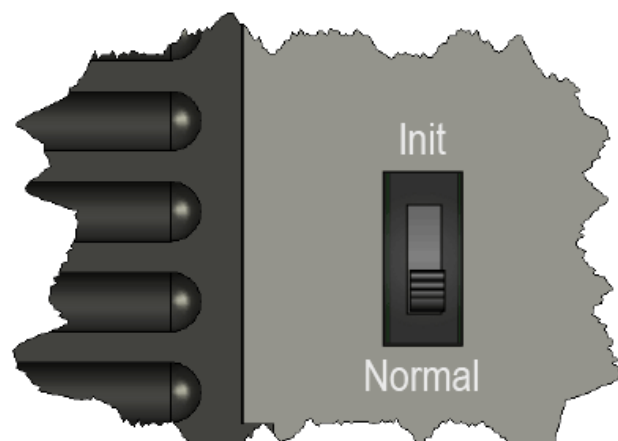

## 2.3. ET-7X00/PET-7X00 Hardware Connections

ET-7X00/PET-7X00 series modules provide a variety of communication interfaces to suit a range of applications. Below is a description of the configuration for simple applications using the ET-7X00/PET-7X00 when implementing both PoE and Non-PoE solutions.

### Non-PoE

---

- i. Connect the PC to the Ethernet Port via the Hub or Switch.
- ii. Connect the positive of the power supply to the terminal marked “(R)+Vs” on the ET-7X00.

Connect the negative of the power supply to the terminal marked “(B)GND” on the ET-7X00.

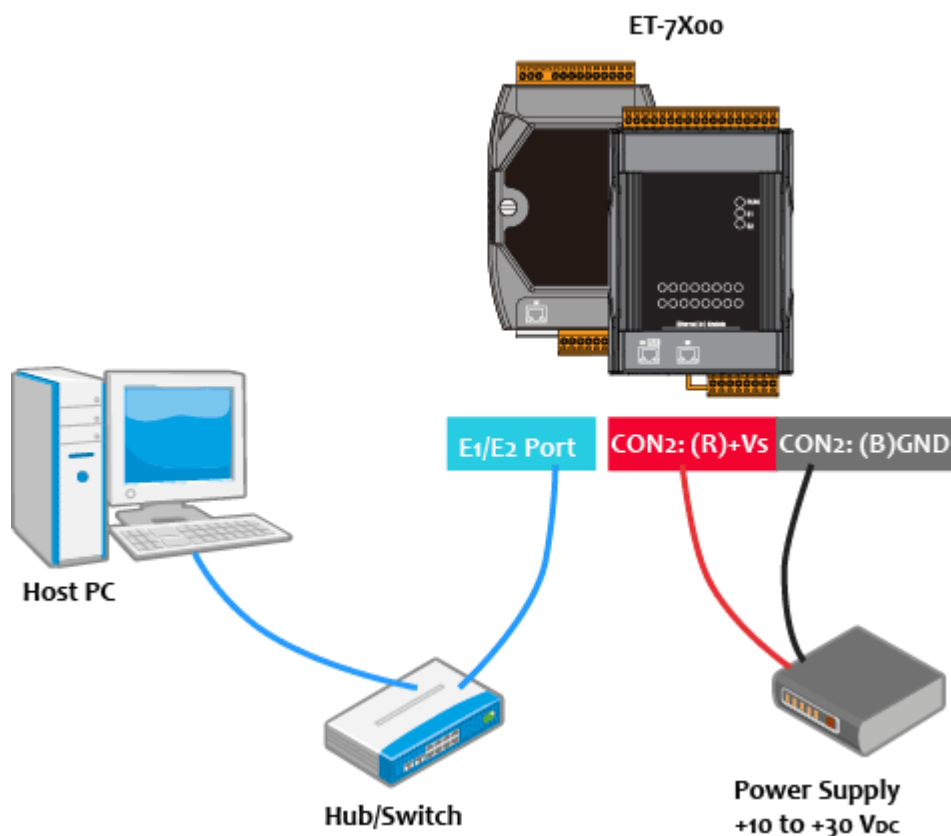

## PoE

- i. Connect the PC to the Ethernet Port via the PoE Switch.
- ii. Connect the power supply to the PoE Switch, which in turn supplies power to the PET-7X00.

### Tips & Warnings



Only the E1 port of the PET-7X00 supports the PoE feature.

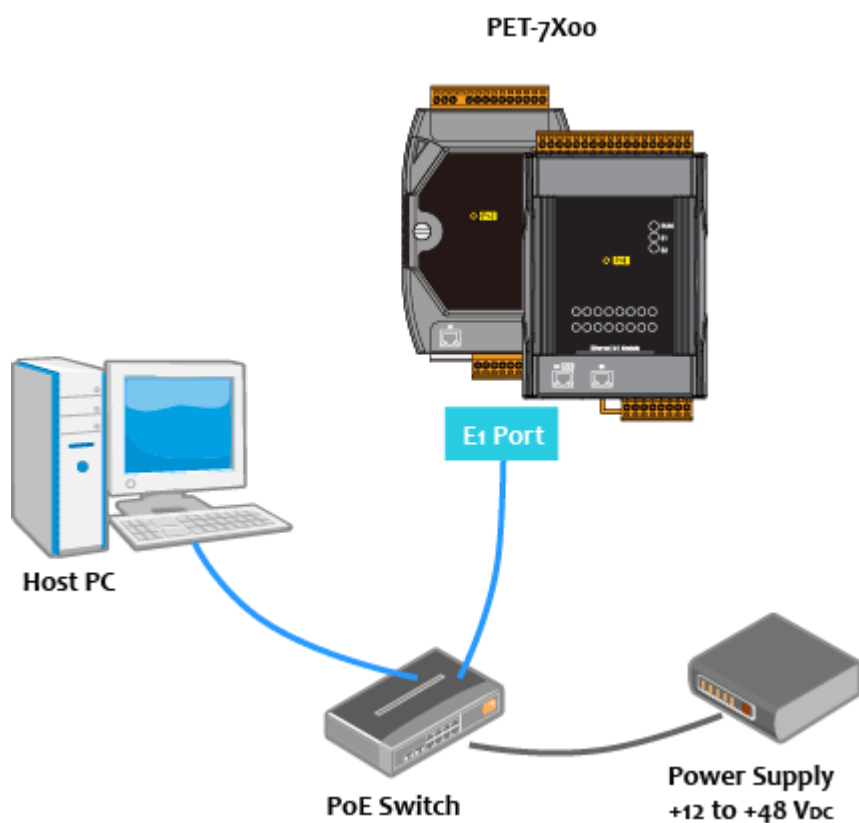
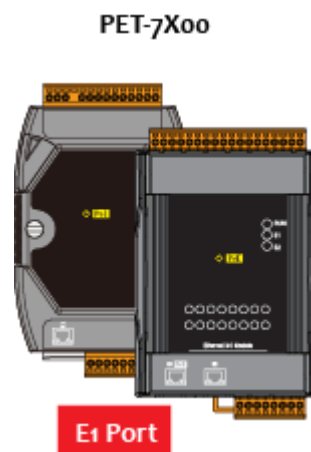

## 2.4. Installing the MiniOS7 Utility

The MiniOS7 Utility is a useful tool that provides a quick and easy way to update the OS image or the firmware, configure the Ethernet settings, and upload files to the ET-7X00/PET-7X00 from a PC.

### Step 1 : Install the MiniOS7 Utility tool

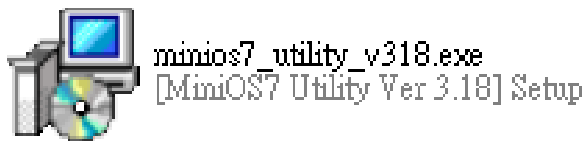

The latest version of the MiniOS7 Utility can be obtained from the companion CD:

CD:\Napdos\Software\minios7\_utility\

or from the ICP DAS FTP site at:

[http://ftp.icpdas.com/pub/cd/6000cd/napdos/software/minios7\\_utility/](http://ftp.icpdas.com/pub/cd/6000cd/napdos/software/minios7_utility/)

### Step 2 : Follow the instructions in the Setup Wizard to complete the installation



After the installation has been completed, a new short cut for the MiniOS7 Utility will be displayed on your desktop.

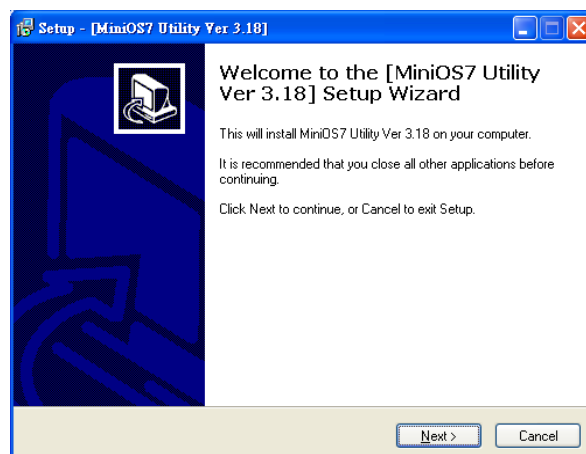



## 2.5. Using the MiniOS7 Utility to Assign an IP Address

The ET-7X00/PET-7X00 is web-based device, and is configured using a default IP address, meaning that you must first assign a new IP address to the ET-7X00/PET-7X00 before operation.

The factory default IP settings are as follows:

Item	Default
IP Address	192.168.255.1
Subnet Mask	255.255.0.0
Gateway	192.168.0.1

### Step 1 : Run the MiniOS7 Utility



Double-click the “MiniOS7 Utility” shortcut on your desktop.

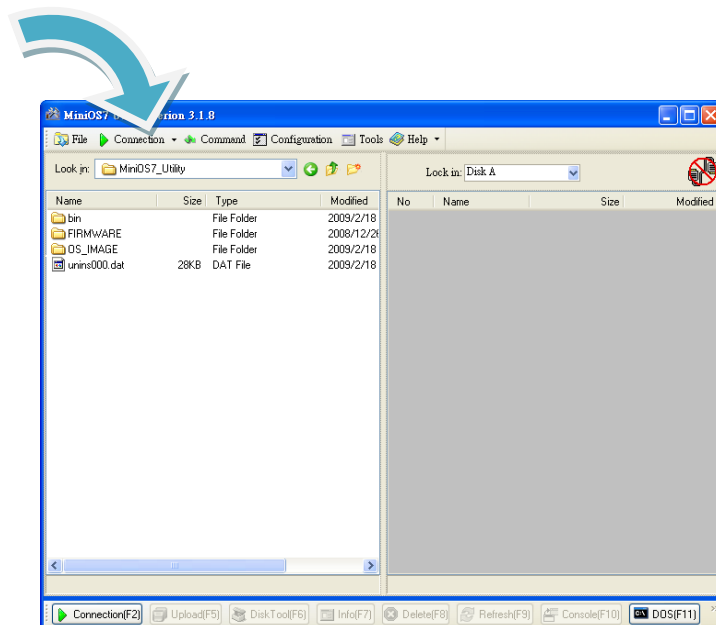

**Step 2 : Press the “F12” key or choose the “Search” option from the “Connection” menu**

After pressing the “F12” key or choosing the “Search” option from “Connection” menu, the utility will perform a search of all MiniOS7 modules on your network.

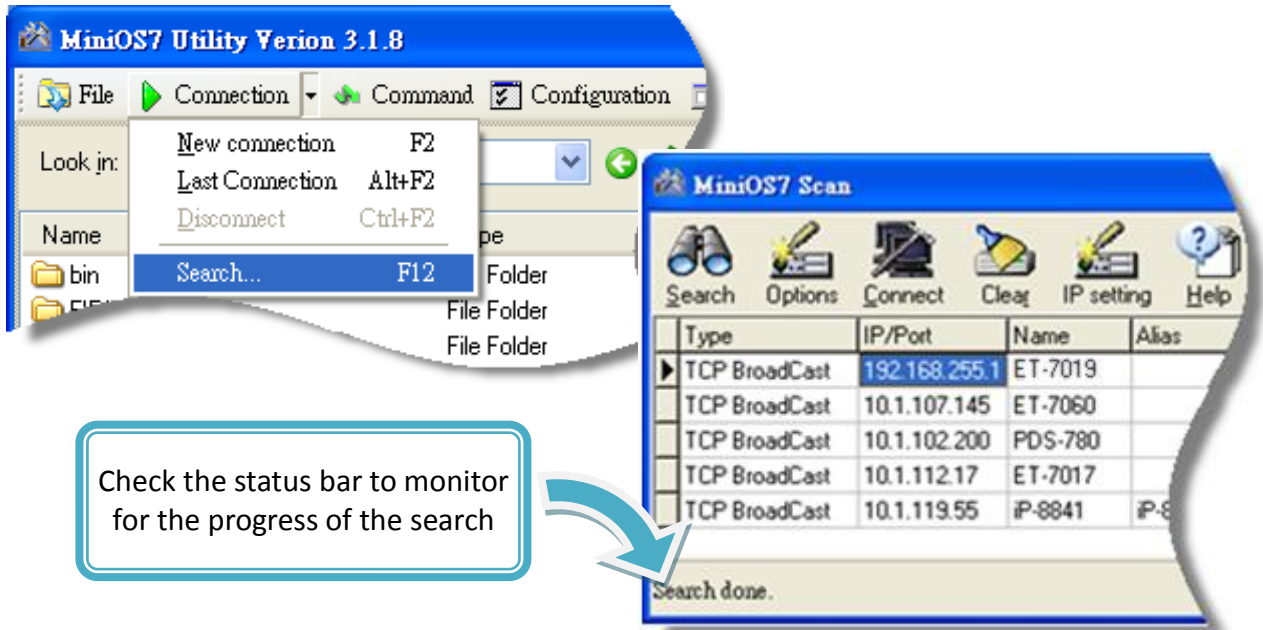

**Step 3 : Click the “192.168.255.1” item in the IP/Port field list and then click the “IP Settings” icon in the toolbar**

After the search has been completed, click the default value “192.168.255.1” in the IP/Port field list, and then click the “IP Settings” icon in the toolbar to display the IP Settings dialog box.

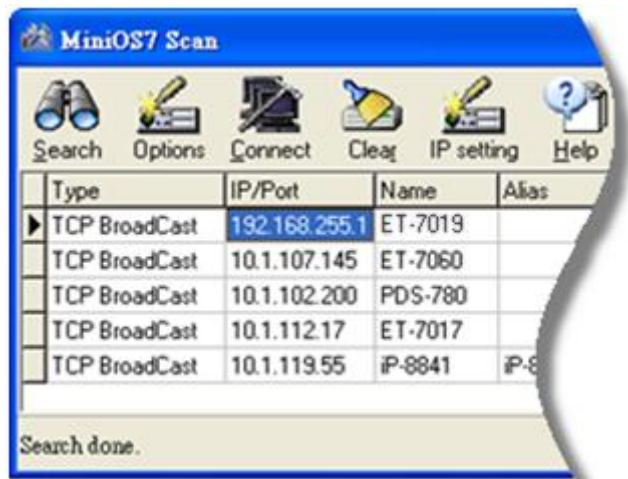

**Step 4 : Assign a new IP address and then click the “Set” button**

In the IP Settings dialog box, you can manually assign an IP Address, Mask Address, Gateway and Alias, or you can use the DHCP function to dynamically assign IP addresses.

Once the appropriate values have been entered, click the “Set” button to save the settings.

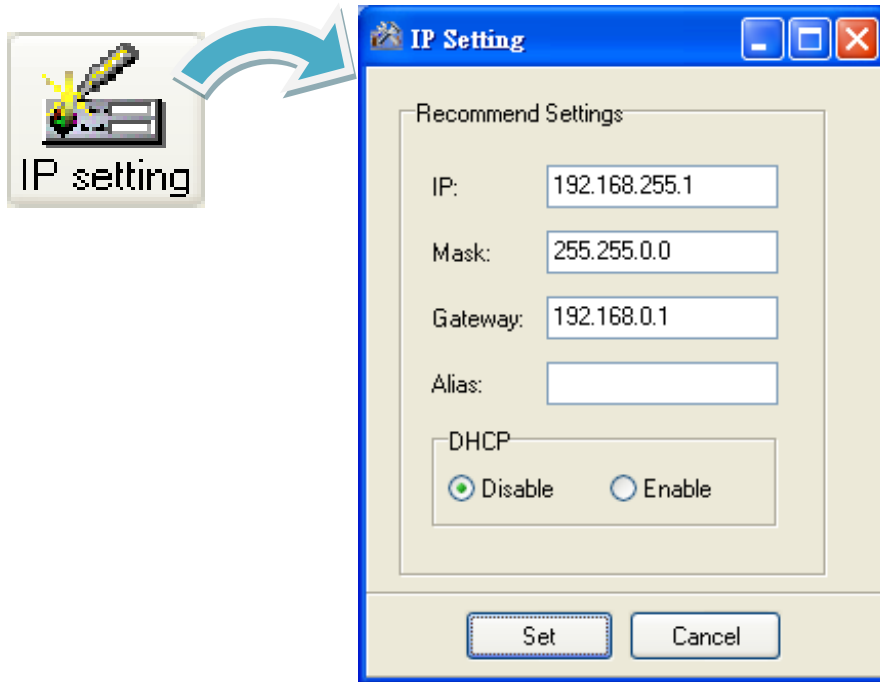

**Step 5 : Reboot the module and then press the “F12” key or click the “Search” option from the “Connection” menu to check the IP settings**

After completing and saving the settings, you should reboot the module and then use the MiniOS7 Utility to perform another search for the module to make sure that the IP settings are correct. See Step 2 for details.

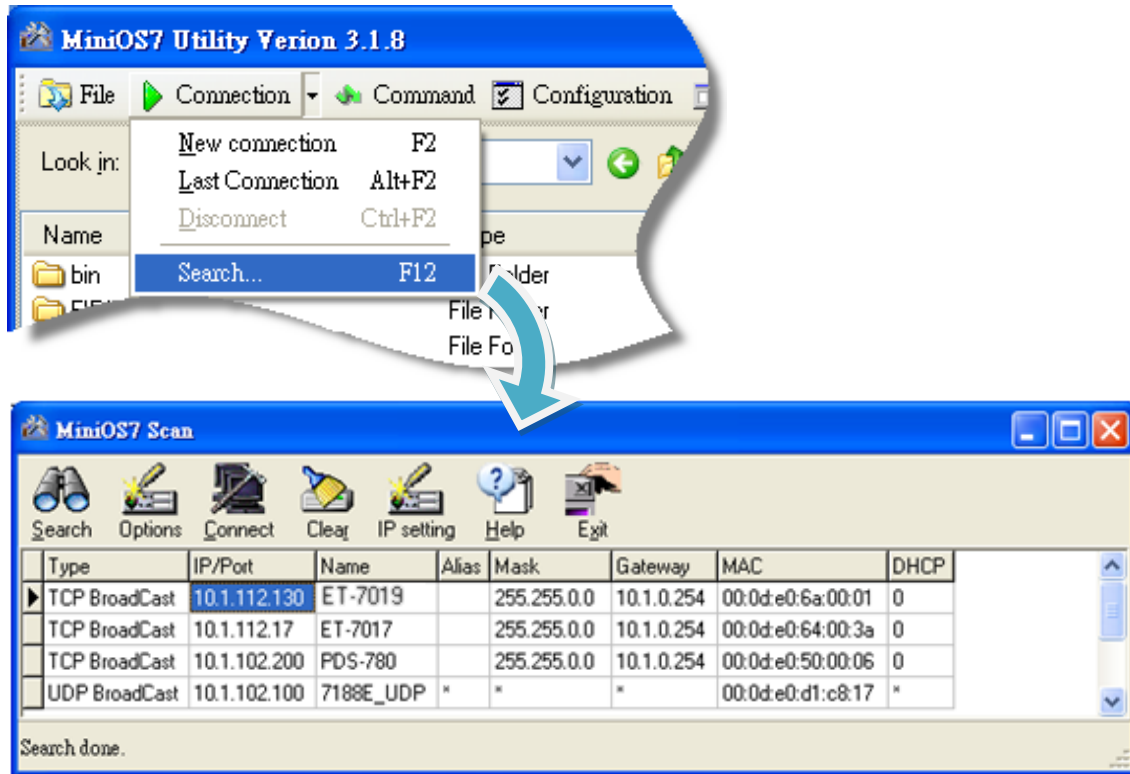

## 2.6. Enabling the Adobe Flash Player in Your Browser

The Web HMI page requires the Adobe Flash Player to be installed. The latest version of the Adobe Flash Player can be downloaded by accessing the Adobe Systems Incorporated website. The following instructions will help you to install the Adobe Flash Player in your web browser.

### Step 1 : Go to the Adobe Flash Player Download Center



The Adobe Flash Player Download Center:

<http://get.adobe.com/flashplayer/>

The Adobe Flash Player is subject to change without notice; refer to <http://www.adobe.com/support/flashplayer/downloads.html> for the latest version of this software.

### Step 2 : Follow the instructions to download the installation file

Click the “Agree and install now” button and follow the instructions to download the installation file. Note that unless you uncheck the option, the Google Toolbar will be included in the installation by default, so if you do not require this feature, be sure to uncheck this option.

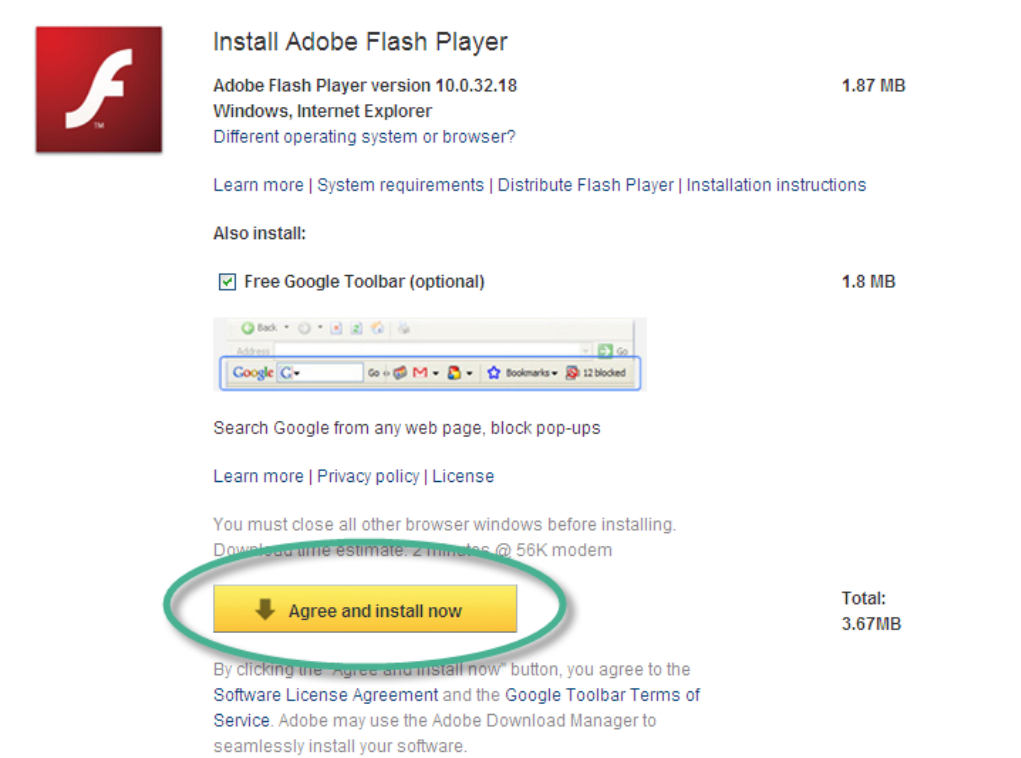

The screenshot shows the Adobe Flash Player download page. It features the Adobe Flash logo on the left. The main content area is titled "Install Adobe Flash Player" and lists the version as "Adobe Flash Player version 10.0.32.18" with a size of "1.87 MB". Below this, there are links for "Learn more", "System requirements", "Distribute Flash Player", and "Installation instructions". A section titled "Also install:" contains a checked checkbox for "Free Google Toolbar (optional)" with a size of "1.8 MB". Below this is a screenshot of the Google Toolbar interface. At the bottom of the page, there is a yellow button with a downward arrow and the text "Agree and install now", which is circled in green. To the right of this button, the total size is listed as "Total: 3.67MB". At the very bottom, there is a disclaimer: "By clicking the 'Agree and install now' button, you agree to the Software License Agreement and the Google Toolbar Terms of Service. Adobe may use the Adobe Download Manager to seamlessly install your software."

## 2.7. Configuring the I/O Functions

The ET-7X00/PET-7X00 series contains an advanced web configuration system that provides users with access to ET-7X00/PET-7X00 series applications through a standard web browser.

**Step 1 : Be sure that the switch is set to the “Normal” position and then reboot the module**

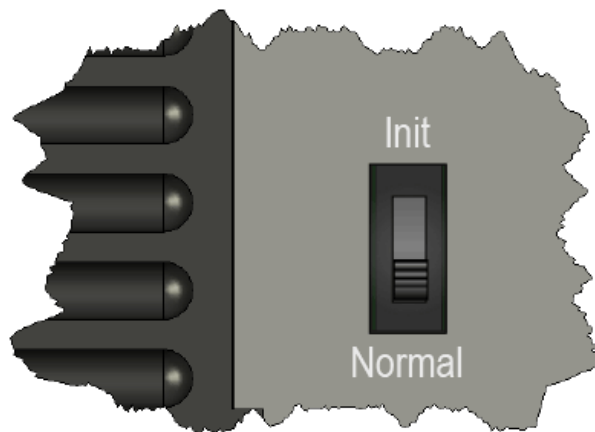

**Step 2 : Open a browser**

Use a standard internet browser to view the ET-7X00/PET-7X00 web pages, such as Mozilla Firefox or Internet Explorer, etc.

**Step 3 : Enter the URL address for the ET-7X00/PET-7X00**

If you haven't changed the default IP address of the ET-7X00/PET-7X00 module, please refer to section 2.5. "Using the MiniOS7 Utility to Assign an IP Address" to configure it.

#### Step 4 : Enter your User name and Password

After entering the IP address, the login dialog box will appear, prompting you to enter your user name and password.

The factory default user name and password are as follows:

Item	Default
User name	Admin
Password	Admin



#### Step 5 : Welcome to the ET-7X00/PET-7X00 web interface

After logging into the ET-7X00/PET-7X00 web interface, the welcome page will be displayed.

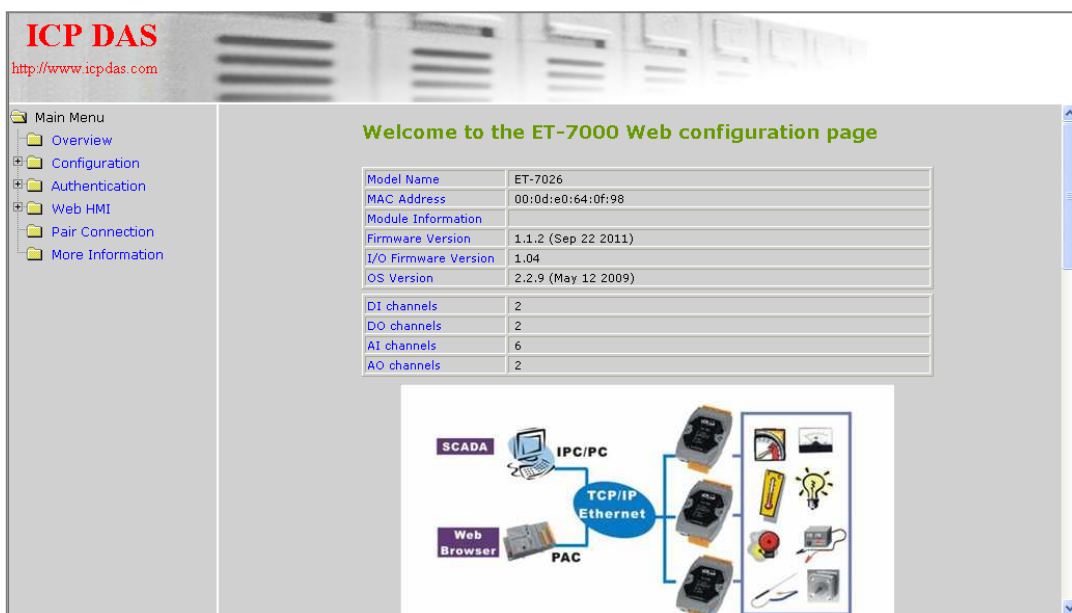

## Step 6 : Configure and browse the I/O functions

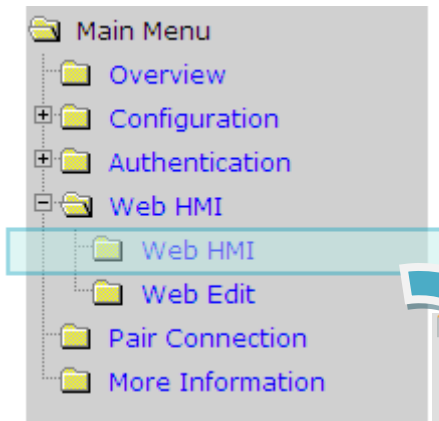

Click the “Web HMI” option in the “Web HMI” section of the Main Menu for the ET-7X00/PET-7X00, and then click the I/O function tabs to configure and browse the I/O functions.

Analog Input	Register	Value	
		Hex Format	Floating Format
AI0	30000	0000	0.000
AI1	30001	0000	0.000
AI2	30002	0000	0.000
AI3	30003	0000	0.000
AI4	30004	0000	0.000
AI5	30005	0000	0.000

No	Register	Latched High			Latched Low		
		Value			Value		
		Hex Format	Floating Format	Register	Hex Format	Floating Format	
AI0	30236	0001	0.000	30268	FFFF	-0.000	
AI1	30237	0000	0.000	30269	FFFF	-0.000	
AI2	30238	0002	0.000	30270	FFFF	-0.000	
AI3	30239	0000	0.000	30271	FFFF	-0.000	
AI4	30240	0002	0.000	30272	FFFF	-0.000	
AI5	30241	0000	0.000	30273	FFFF	-0.000	

For more detailed information related to the I/O specification, pin assignment, and I/O functions, etc. for each ET-7X00/PET-7X00, please refer to “ET7000\_ET7200 Register Table”, which can be obtained from:

CD:\NAPDOS\ET7000\_ET7200\document\

**ET-7005/PET-7005**

**I/O Specifications**

<b>Thermistor Input</b>	8 (Differential)
Input Channels	8 (Differential)
Sensor Type	PT100 (I-AS, Fenwell U, YSI L100, YSI L300, YSI L1000, YSI B2252, YSI B3000, YSI B5000, YSI B6000, YSI B10000, YSI H10000, YSI H30000, User-defined)
Individual Channel Configuration	Yes
Resolution	16-bit
Sampling Rate	10 Samples/Sec. (Total)
Accuracy	+/-0.1% or better
Zero Drift	+/-20 uV/C
Span Drift	+/-25 ppm/C
Over voltage Protection	110 V <sub>DC</sub> /V <sub>AC</sub>
Common Mode Rejection	80 dB
Normal Mode Rejection	100 dB
Open Wire Detection	Yes

**Digital Output**

Output Channels	4
Type	Isolated Open Collector (Sink)
Max. Load Current	700 mA/Channel
Load Voltage	5 V <sub>DC</sub> ~ 50 V <sub>AC</sub>
Overvoltage Protection	50 V <sub>DC</sub>
Overload Protection	1.4 A
Short-circuit Protection	Yes
Power-on Value	Yes, Programmable
Safe Value	Yes, Programmable

**Wire Connections**

**Modbus Register Table**

**Coils (0xxxx)**

Register	HEX	Points	Description
00000	0000	4	DO value
00003	0003		
00162	00A2	8	Clear 1-ch historical AI max. value
00169	00A9		
00194	00C2	8	Clear 1-ch historical AI min. value
00201	00C9		
00226	00E2	1	Reset the I/O settings to the factory default
00233	00E9	1	Reboot module
00431	01AF	1	Save the DO power-on value to the EEPROM
00432	01B0	1	Save the DO safe value to the EEPROM
00435	01B3		
00438	01B6	4	Enable/Disable the DO power-on value function
00515	0203		
00518	0206	4	Enable/Disable the DO safe value function
00595	0253		
00602	025A	8	Enable/Disable the AI function
00627	0273	1	Set the temperature scale
00631	0277	1	Set the AI data format
00632	0278	1	Reset the AI calibration to the factory settings
00634	027A	1	Clear all historical AI max. values
00635	027B	1	Clear all historical AI min. values
00636	027C		
00643	028F		



## 3. Web Applications

The ET-7X00/PET-7X00 contains an advanced web configuration system that provides users with access to ET-7X00/PET-7X00 applications through a standard web browser.

### Logging into the ET-7X00/PET-7X00 web pages

You can log into the ET-7X00/PET-7X00 web pages from any computer that has Internet access.

#### Step 1 : Open a browser

Use a standard internet browser to view the ET-7X00/PET-7X00 web pages, such as Mozilla Firefox or Internet Explorer, etc.

#### Step 2 : Enter the URL address for the ET-7X00/PET-7X00

If you haven't changed the default IP address of the ET-7X00/PET-7X00 module, please refer to section 2.5. "Using the MiniOS7 Utility to Assign an IP Address" to configure it.

### Step 3 : Enter your User name and Password

After entering the IP address, the login dialog box will appear, prompting you to enter your user name and password.

The factory default user name and password are as follows:

Item	Default
User name	Admin
Password	Admin



#### Step 4 : Welcome to the ET-7X00/PET-7X00 web interface

After logging into the ET-7X00/PET-7X00 web interface, the welcome page will be displayed.

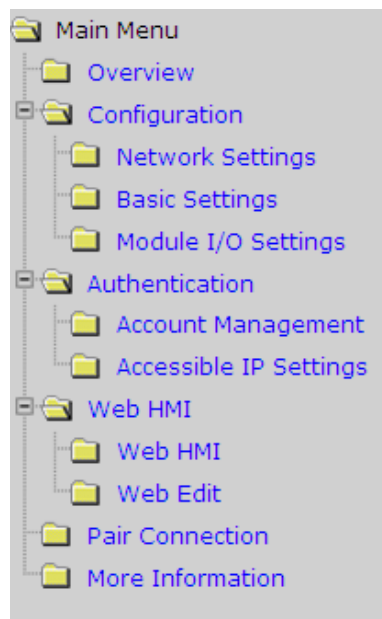
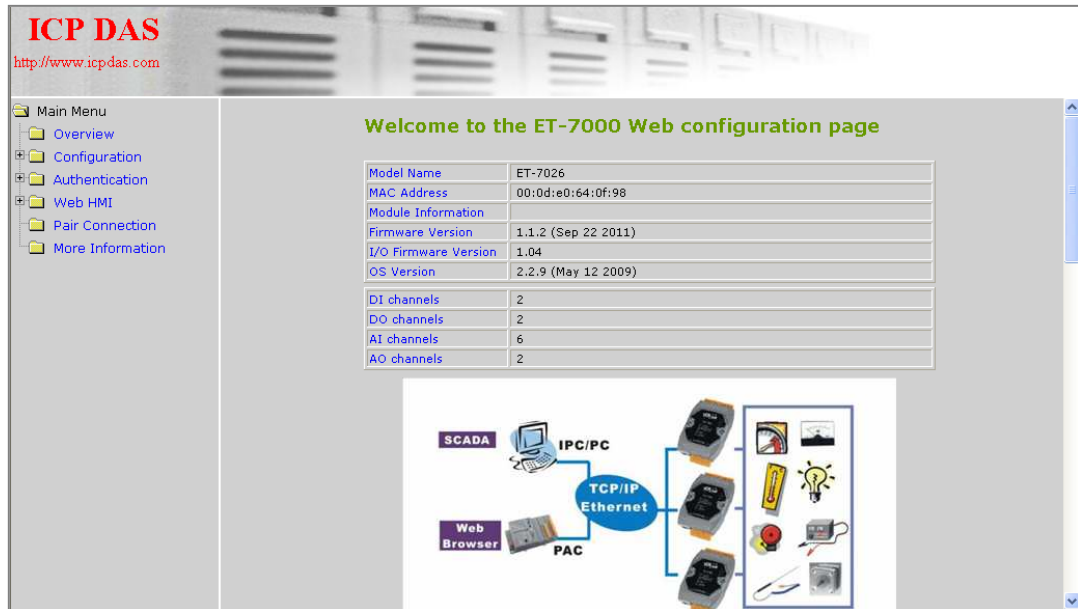

This web interface provides a number of functions, which can be easily accessed via the menu on the left hand side of the page.

### 3.1. Overview

The “Overview” option in the Main menu provides a brief introduction to and explanation of the web interface.

The “Overview” option links to the welcome page and contains two main parts.

The top section of the page provides some basic information about both the ET-7X00/PET-7X00 hardware and software.

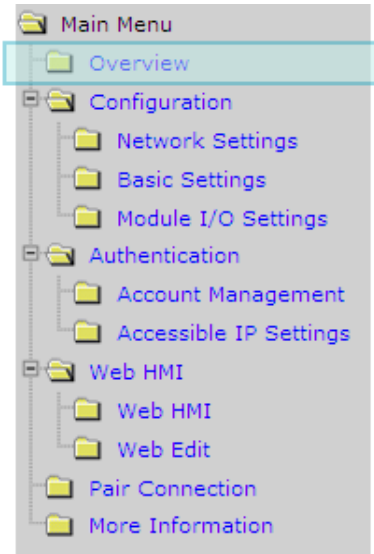

**Welcome to the ET-7000 Web configuration page**

Model Name	ET-7026
MAC Address	00:0d:e0:64:00:3d
Module Information	
Firmware Version	1.1.4 (Dec. 21, 2012)
IO Version	1.07
OS Version	2.2.10 (Jun. 4, 2009)
DI channels	2
DO channels	2
AI channels	6
AO channels	2

The lower section of the page provides a brief introduction to the web interface.

### General Description

The ET-7000 series is a selection of cost effective, high performance 10/100 Mbps I/O modules designed for remote data collection and remote Ethernet application control. Each ET-7000 module includes its own internal Ethernet configuration, Modbus TCP/IP port and web port, with a built-in simple HMI that makes configuration and access easy, together with an I/O LED display to indicate the current transmission status.

The ET-7000 supports Modbus/TCP without the need for any additional programming. It can be easily connected to most SCADA software, such as Indusoft, iFix and Labview. The ET-7000 also supports web server access allowing the user to monitor and access the remote I/O from a web browser. We also provide a JavaScript page for ET-7000 as a reference guide allowing user to design custom web interfaces.

### Configuration

- [Network Settings](#)

IP address, Net mask, default gateway, DHCP, Static or Dynamic IP, Firmware and OS version information...

- [Basic Settings](#)

Module name, Module information, Real Time Clock, Time Server IP address, Web HMI and Telnet console Enable, Disable functions. Load the factory default settings

- [Module I/O Settings](#)

Module I/O configuration including DI latch, Digital Counter Enabled/Disabled functions  
Settings for Watchdog Timer, DO Power-On value and Safe values, AI High/Low alarm...

## 3.2. Configuration

The “Configuration” section of the Main menu contains the following options:

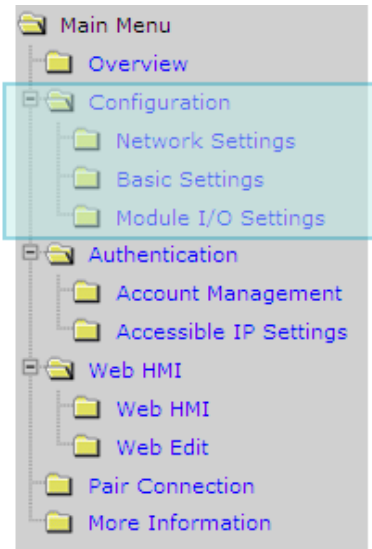

### **Network Settings:**

Provides access to the Ethernet Settings page which allows you to access the IP settings and check the software version.

### **Basic Settings:**

Provides access to the Basic Settings page which allows you to configure the basic information for the web interface.

### **Module I/O Settings:**

Provides access to the Common Functions page which allows you to configure the settings for the module I/O.

### 3.2.1. Network Settings

The Network Settings page allows you to perform the following functions:

- (A) Configure the network settings
- (B) Check the software information

Items	Current Value	New Value
IP Address	10.1.112.17	<input type="text" value="10.1.112.17"/>
Gateway	10.1.0.254	<input type="text" value="10.1.0.254"/>
Subnet Mask	255.255.0.0	<input type="text" value="255.255.0.0"/>
DHCP	<input type="radio"/> Enabled <input checked="" type="radio"/> Disabled	
Web Server Lib. Version	Version 127 (Dec. 24, 2012)	
MiniOS7 Version	Version 2.02.10	

Please access the new IP Address after modifying the configuration

#### (A) Configuring the Network Settings

In general, network settings include the following parameters:

- **An IP address:** Each ET-7X00/PET-7X00 on the network must have a unique IP address.
- **A default gateway:** A gateway (or router) is a system that is used to connect a network with one or more other networks.
- **A subnet mask:** The subnet mask indicates which portion of the IP address that is used to identify the local network or subnet.

There are two methods of configuring the network settings:

- **Dynamic configuration:** The Dynamic Host Configuration Protocol (DHCP) is a network application protocol that automatically assigns an IP address to a device.
- **Manual configuration:** In the absence of DHCP, ET-7X00/PET-7X00 modules can be manually configured with an IP address, mask, and a gateway.

## Dynamic Configuration

If a DHCP server is present on the network, the ET-7X00/PET-7X00 will automatically obtain the network settings from the DHCP server when the DHCP function is enabled.

**Step 1 :** Enable the DHCP by checking the “**Enabled**” radio button.

**Step 2 :** Click the “**Modify Settings**” button to finish configuring the network settings.

Items	Current Value	New Value
IP Address	10.1.112.17	10.1.112.17
Gateway	10.1.0.254	10.1.0.254
Subnet Mask	255.255.0.0	255.255.0.0
DHCP	<input checked="" type="radio"/> Enabled <input type="radio"/> Disabled	
Web Server Lib. Version	Version 127 (Dec. 24, 2012)	
MiniOS7 Version	Version 2.02.10	

**Modify Settings**

Please access the new IP Address after modifying the configuration

## Manual Configuration

When using manual configuration, all network settings need to be assigned manually. Each ET-7X00/PET-7X00 module should have a unique IP address assigned to the interface in order to identify itself on the network.

**Step 1 :** Disable the DHCP by checking the “**Disabled**” radio button.

**Step 2 :** Enter the relevant network settings information into the respective fields .

**Step 3 :** Click the “**Modify Settings**” button to finish configuring the network settings.

Items	Current Value	New Value
IP Address	10.1.112.17	10.1.112.17
Gateway	10.1.0.254	10.1.0.254
Subnet Mask	255.255.0.0	255.255.0.0
DHCP	<input type="radio"/> Enabled <input checked="" type="radio"/> Disabled	
Web Server Lib. Version	Version 127 (Dec. 24, 2012)	
MiniOS7 Version	Version 2.02.10	

**Modify Settings**

Please access the new IP Address after modifying the configuration



## (B) Checking the Software Information

The software information section includes the following items:

- **Web Server Lib. Version:** This item provides details of the version number for the web server library, which is a collection of web development solutions that are providing by ICPDAS for use with custom applications.
- **MiniOS7 Version:** This item provides defaults of the version number for the MiniOS7 OS image, which is an embedded operating system specifically designed for use with ICP DAS controllers.

Ethernet Settings		
Items	Current Value	New Value
IP Address	10.1.112.17	<input type="text" value="10.1.112.17"/>
Gateway	10.1.0.254	<input type="text" value="10.1.0.254"/>
Subnet Mask	255.255.0.0	<input type="text" value="255.255.0.0"/>
DHCP	<input type="radio"/> Enabled <input checked="" type="radio"/> Disabled	
Web Server Lib. Version	Version 127 (Dec. 24, 2012)	
MiniOS7 Version	Version 2.02.10	
<input type="button" value="Modify Settings"/>		

Please access the new IP Address after modifying the configuration

This page can be used to check the version information for the ET-7X00/PET-7X00 software after updating the ET-7X00/PET-7X00 firmware (see section 6.4 . “Uploading the ET-7X00/PET-7X00 firmware” for more details).

## 3.2.2. Basic Settings

The “Basic Settings” page allows you to perform the following functions:

- (A) Configure the module information
- (B) Configure the web interface information
- (C) Reset all parameters to the default settings

**Basic Settings**

Module Name	ET-7255/PET-7255
Module Information	<input type="text"/> <small>Maximum of 16 characters (72)</small>
Page Header Information (First line)	<input type="text" value="ICP DAS"/> <small>Maximum of 20 characters</small>
	Color <input type="text" value="Blue"/> Font Size <input type="text" value="7"/>
Page Header Information (Second line)	<input type="text" value="http://www.icpdas.com"/> <small>Maximum of 50 characters</small>
	Color <input type="text" value="Red"/> Font Size <input type="text" value="4"/>
More Information URL	<input type="text" value="http://www.icpdas.com/products/Remote_IO/et-7000/et-7000_introduction.htm"/>
Web Server Port	<input type="text" value="80"/>
Modbus TCP Port	<input type="text" value="502"/>
Modbus TCP Port (WAN)	<input type="text" value="502"/> <small>This setting can be ignored if ET-7000/PET-7000 is used</small>

**Restore All Default Settings**

- Configuration
- Authentication
- Web HMI
- Pair Connection
- All

## (A) Configuring the Module Information

The “Module Information” section includes the following items:

- **Module Name:** The initial value for this field will depend on the model of the module and can not be modified.
- **Module Information:** The module information field indicates the name of the alias that is used to identify the module.

To configure the module information, follow the procedure below:

**Step 1 :** Enter the Module information in the relevant field.

**Step 2 :** Click the “**Submit**” button to finish configuring the module information.

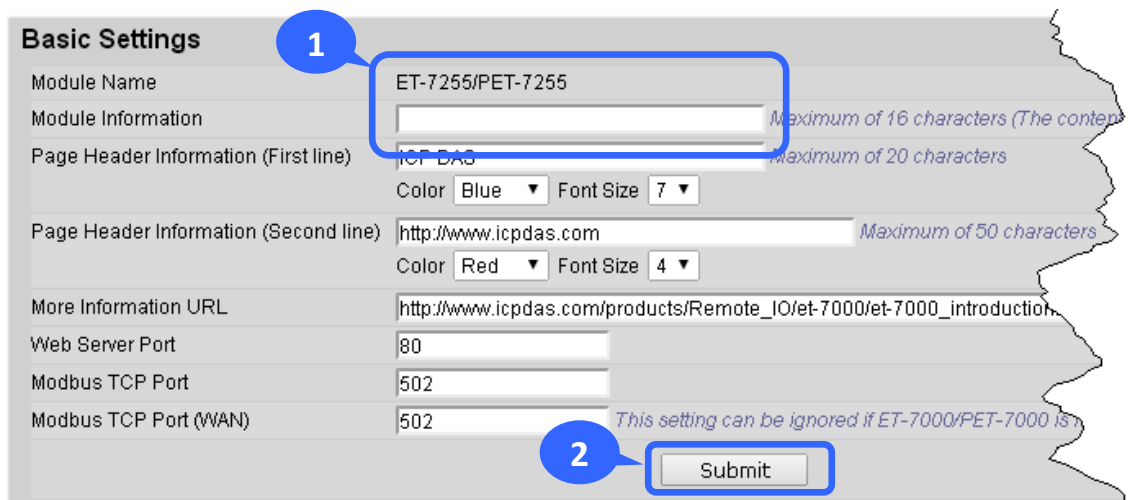

Basic Settings	
Module Name	ET-7255/PET-7255
Module Information	<input type="text"/> <small>Maximum of 16 characters (The content)</small>
Page Header Information (First line)	ICP DAS <small>Maximum of 20 characters</small>
	Color <input type="text" value="Blue"/> Font Size <input type="text" value="7"/>
Page Header Information (Second line)	<input type="text" value="http://www.icpdas.com"/> <small>Maximum of 50 characters</small>
	Color <input type="text" value="Red"/> Font Size <input type="text" value="4"/>
More Information URL	<input type="text" value="http://www.icpdas.com/products/Remote_IO/et-7000/et-7000_introduction..."/>
Web Server Port	<input type="text" value="80"/>
Modbus TCP Port	<input type="text" value="502"/>
Modbus TCP Port (WAN)	<input type="text" value="502"/> <small>This setting can be ignored if ET-7000/PET-7000 is</small>
	<input type="button" value="Submit"/>

## (B) Configuring the Web Interface Information

The module information section includes the following items:

- **Page Header Information (First line)** and **Page Header Information (Second line)**:  
The title of the website that is displayed the top left-hand corner of the interface, for example the company name and web address as per the example below.

The screenshot shows the configuration interface for the ICP DAS ET-7026 module. The 'Basic Settings' section is visible, with the following fields:

Module Name	ET-7026
Module Information	DIO, AIO <small>(Maximum of 16 characters) (The content cannot include ' or ' character)</small>
Page Header Information (First line)	ICP DAS <small>(Maximum of 20 characters)</small>
Page Header Information (Second line)	http://www.icpdas.com <small>(Maximum of 50 characters)</small>
More Information URL	http://www.icpdas.com/products/Remote_IO/et-7000/et-7000 <small>(Maximum of 100 characters)</small>
Web Server TCP Port	80
Modbus Server Port	502

A 'Submit' button is located at the bottom right of the configuration area. A blue arrow points from the 'Main Menu' on the left to the 'More Information' option.

- **More Information URL**:  
This item allows you to specify the URL that will be displayed when the “More information” option in the Main Menu is clicked in order to provide additional support for the ET-7X00/PET-7X00. After completing the settings, click the “More Information” option to check that the link to the web site is correct (As per the figure below).



- **Web Server Port:** This option specifies which port is to be used for the web server. By default, the HTTP port is 80.
- **Modbus TCP Port:** This option specifies which port is to be used for communication on the Modbus TCP. By default, the Modbus protocol uses port 502.
- **Modbus TCP Port (WAN):** This option specifies which port is to be used for Modbus communication between the remote host and local EX-7X00/PET-7X00. This settings can be ignored if ET-7X00/PET-7X00 is not located behind a router.

**Basic Settings**

Module Name	ET-7255/PET-7255		
Module Information	<input type="text"/>	<i>Maximum of 16 characters (The content)</i>	
Page Header Information (First line)	ICP DAS <i>Maximum of 20 characters</i>		
	Color	Blue ▼	Font Size 7 ▼
Page Header Information (Second line)	http://www.icpdas.com <i>Maximum of 50 characters</i>		
	Color	Red ▼	Font Size 4 ▼
More Information URL	http://www.icpdas.com/products/Remote_IO/et-7000/et-7000_introduction		
Web Server Port	<input type="text" value="80"/>		
Modbus TCP Port	<input type="text" value="502"/>		
Modbus TCP Port (WAN)	<input type="text" value="502"/>	<i>This setting can be ignored if ET-7000/PET-7000 is not located behind a router.</i>	
<input type="button" value="Submit"/>			

To configure the web interface information, follow procedure below:

**Step 1 :** Enter the desired information into the respective fields.

**Step 2 :** Click the “Submit” button to finish configuring the module information.

**Basic Settings**

Module Name	ET-7255/PET-7255		
Module Information	<input type="text"/>	<i>Maximum of 16 characters (The content)</i>	
Page Header Information (First line)	ICP DAS <i>Maximum of 20 characters</i>		
	Color	Blue ▼	Font Size 7 ▼
Page Header Information (Second line)	http://www.icpdas.com <i>Maximum of 50 characters</i>		
	Color	Red ▼	Font Size 4 ▼
More Information URL	http://www.icpdas.com/products/Remote_IO/et-7000/et-7000_introduction		
Web Server Port	<input type="text" value="80"/>		
Modbus TCP Port	<input type="text" value="502"/>		
Modbus TCP Port (WAN)	<input type="text" value="502"/>	<i>This setting can be ignored if ET-7000/PET-7000 is not located behind a router.</i>	
<input type="button" value="Submit"/>			

## (C) Resetting All Settings to Default

The reset function is divided into categories based on the menu options for the web interface, and can be used to restore the individual settings to their factory default state.

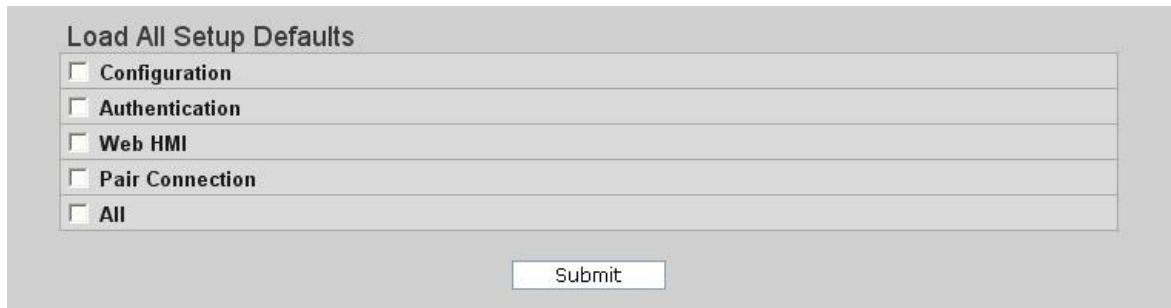

Load All Setup Defaults

- Configuration
- Authentication
- Web HMI
- Pair Connection
- All

Submit

### Tips & Warnings



For ET-7200/PET-7200 modules, in addition to using the reset function in the web-based Basic Settings page, you can also use the reset button to restore the ET-7200/PET-7200 to factory defaults. For more information about the reset button, please refer to section 1.2. "Overview".

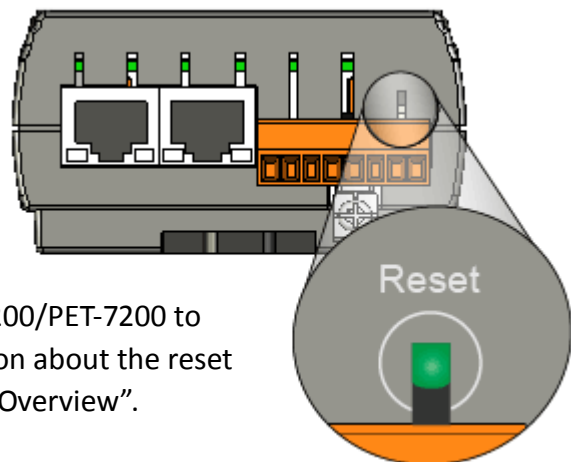

To reset the settings to their factory default, follow the procedure below:

**Step 1** : Check the relevant check boxes for the items you wish to reset.

**Step 2** : Click the "Submit" button to reset the settings to their factory default state.

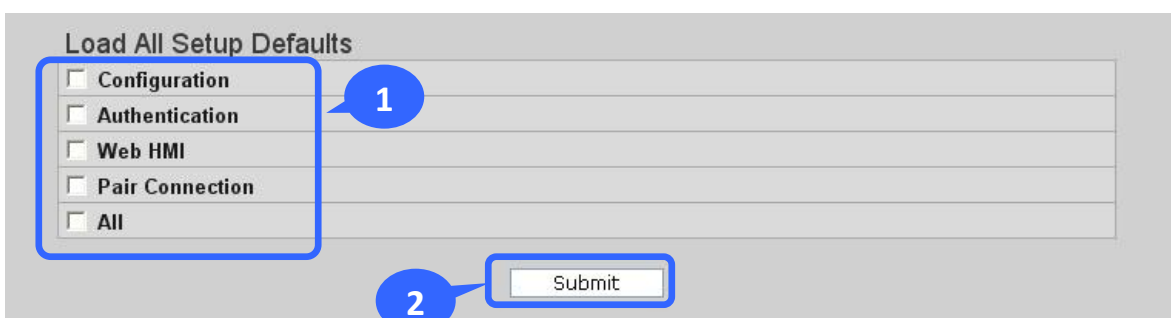

Load All Setup Defaults

- Configuration
- Authentication
- Web HMI
- Pair Connection
- All

Submit

## (a) Factory Default Settings for the “Configuration” Menu Options

The tables below outline the factory default settings for the items listed in the “Configuration” menu.

### Network Settings

#### Ethernet Settings

Item	Factory Default Settings
IP Address	192.168.255.1
Gateway	192.168.0.1
Subnet Mask	255.255.0.0
DHCP	Disabled

### Basic Settings

#### Basic Settings

Item	Factory Default Settings
Module Name	Depends on the name of the module
Module Information	Empty
Page Header Information (First line)	ICP DAS
Page Header Information (Second line)	<a href="http://www.icpdas.com">http://www.icpdas.com</a>
More Information URL	<a href="http://www.icpdas.com/root/product/solutions/remote_io/ethernet_io/et-7000_introduction.html">http://www.icpdas.com/root/product/solutions/remote_io/ethernet_io/et-7000_introduction.html</a>
Web Server Port	80
Modbus TCP Port	502
Modbus TCP Port (WAN)	502

## Module I/O Settings

The information displayed on the settings page varies depending on the model number.

### Common Functions

Item	Factory Default Settings
Host WDT Timeout	0 (Disabled)
WDT Event Counter	0
Modbus NetID	1

### Digital Output

Item	Factory Default Settings
Power-on Value	OFF
Safe Value	OFF

### Digital Input

Item	Factory Default Settings
DI Latch Status	Disabled
DI Counter	Disabled

### Analog Output

Item	Factory Default Settings	
Output Range	This value varies depending on the model of the module	
Output Slew Rate	0 (Immediate)	
Power-on Value	0	
Safe Value	0	
Data Format	2's Comp Hexadecimal	2's Comp Hexadecimal
	Engineering Unit	



### **Analog Input**

Item		Factory Default Setting
Input Range		This value varies depending on the model of the module
Enable		ON
High Alarm	Alarm Limit Value	This value varies depending on the model of the module
	Enable	OFF
	Alarm Mode	Momentary
Low Alarm	Alarm Limit Value	This value varies depending on the model of the module
	Enable	OFF
	Alarm Mode	Momentary
Sampling Rate	Normal mode (10 Hz)	Normal mode
	Fast mode (50 Hz)	
Filter Setting	60 Hz Rejection	60 Hz Rejection
	50 Hz Rejection	
Data Format	2's Comp Hexadecimal	2's Comp Hexadecimal
	Engineering Unit	

**Note:** The analog input and the analog output share the same data format settings.

## (b) Factory Default Settings for the “Authentication” Menu Options

The tables below outline the factory default settings for the items listed in the “Authentication” menu.

### Account Management

Factory Default Settings
A default user account consists of an account name, “Admin”, and a password, “Admin”.

### Accessible IP Settings

Factory Default Settings
Empty, there is no limit allowing any outgoing access.

### (c) Factory Default Settings for “Web HMI” Menu Option

The tables below outline the factory default settings for the items listed in the “Web HMI” menu.

#### Web HMI

Factory Default Settings
Depends on the Modbus setting function of the ET-7X00/PET-7X00.

#### Web Edit

Factory Default Settings
0 Pages

### (d) Factory Default Settings for the “I/O Pair Connection” Menu Option

The table below outlines the factory default settings for the “Pair Connection” option.

#### Pair Connection

Factory Default Settings
Empty

### 3.2.3. Module I/O Settings

After completing the general configuration of the ET-7X00/PET-7X00 module described in the previous section, the settings for the input and output channels need to be configured, such as the channel range and the alarm, etc.

**Common Functions**  
Common Functions

Modbus Address	Function	Action
00226	Reset to Factory Default Settings	<input type="checkbox"/>
00233	Reboot ET-7000	<input type="checkbox"/>
40555	CPU Reset Status	<input type="text" value="2"/> 1=Power-on, 2=Module WDT, 3=Reset command
40556	Reset Event Counter	<input type="text" value="2"/>
40557	Host WDT Timeout	<input type="text" value="0"/> 0=Disabled, 6~65535=Enabled (units:seconds) (default=0)
40558	WDT Event Counter	<input type="text" value="0"/>

Submit

**Modbus Definition**

Modbus Address	Function	Action
40271	Modbus NetID	<input type="text" value="1"/> 1 ~ 255 (default=1)

Submit

#### Tips & Warnings



The contents displayed on this page will be depending on the Modbus functions applicable to the specific the ET-7X00/PET-7X00 module. Please refer to the user manual for each module for details of how to configure the relevant I/O settings.

In this example, the ET-7026/PET-7026 will be used in order to explain the I/O settings. (The ET-7026/PET-7026 is a multi-function module that has 6 AI channels, 2 AO channels, 2 DI channels and 2 DO channels.)

## (A) Common Functions

The Common Functions area provides options that allow the settings for the Modbus functions to be configured.

### Common Functions

Common Functions

Modbus Address	Function	Action
00226	Reset to Factory Default Settings	<input type="checkbox"/>
00233	Reboot ET-7000	<input type="checkbox"/>
40555	CPU Reset Status	<input type="text" value="2"/> <small>1=Power-on, 2=Module WDT, 3=Reset command</small>
40556	Reset Event Counter	<input type="text" value="2"/>
40557	Host WDT Timeout	<input type="text" value="0"/> <small>0=Disabled, 6-65535=Enabled (units:seconds) (default=0)</small>
40558	WDT Event Counter	<input type="text" value="0"/>

### Modbus Definition

Modbus Address	Function	Action
40271	Modbus NetID	<input type="text" value="1"/> <small>1 ~ 255 (default=1)</small>

## (B) Digital Output Settings

The Digital Output settings area provides details of the configuration settings for all digital output channels.

**Digital Output Settings**  
Power-on/Safe Values

Channel	Power-on Value (00435)	Safe Value (00515)
Ch0	OFF <input checked="" type="radio"/> ON <input type="radio"/>	OFF <input checked="" type="radio"/> ON <input type="radio"/>
Ch1	OFF <input checked="" type="radio"/> ON <input type="radio"/>	OFF <input checked="" type="radio"/> ON <input type="radio"/>

*Note: The default value for all parameters is OFF.*

- **Power-on Value:** This section is used to set the power-on value for a specific digital output channel. The digital output channel will then generate the start-up value output.
- **Safe Value:** When communication between the Host PC and the ET-7X00/PET-7X00 module interrupted is broken, the digital output channels can generate a predefined safe value. This function can be enabled by configuring the Host WDT Timeout setting.

For a more detailed description of these Modbus functions, please refer to: "Appendix C. Modbus Application Notes".

## (C) Digital Input Settings

All digital input channels in ET-7X00/PET-7X00 modules can be used as 32-bit counters and each counter consists of two address values, the Low word and the High word. Specific individual DI channels can be counters via the Digital Input settings web page.

### Digital Input Settings

#### DI Latch

Modbus Address	Function	Action
00350	Enable DI Latched Status	OFF <input checked="" type="radio"/> ON <input type="radio"/> 0=Disabled, 1=Enabled (default=0)

#### DI Counter

Channel	Enabled (00351)	Preset Value for DI Counter (40200)
Ch0	OFF <input checked="" type="radio"/> ON <input type="radio"/>	<input type="text" value="0"/> 0~4294967294 (default=0)
Ch1	OFF <input checked="" type="radio"/> ON <input type="radio"/>	<input type="text" value="0"/> 0~4294967294 (default=0)

- **DI Latched**: When DI Latch function is enabled, once the digital input channel detects any change in input status, the input status will be latched and will remain in this condition the latch is manually.
- **DI Counter**: When Counter mode is selected, one counter will record the number of pulses from the digital signal for the selected channel, and will then record the count value in the register.
- **Preset Value**: This option allows the default values for the counters to be set.



## (D) Analog Output Settings

The Analog Output settings area contains two parts, the Basic Settings section and the Power-on/Safe Values section, which will be described in detail below.

### Analog Output Settings

#### Basic Settings

Channel	Range (40459)	Slew Rate (40523)
Ch0	32.0 V ~ 10 V	0 (Immediate)
Ch1	32.0 V ~ 10 V	0 (Immediate)

#### Power-on/Safe Values

Channel	Power-on Value (40360)	Safe Value (40392)
Ch0	0.000 0 V ~ 10 V	0.000 0 V ~ 10 V
Ch1	0.000 0 V ~ 10 V	0.000 0 V ~ 10 V

## Tips & Warnings



Before selecting the output range for each analog output channel, make sure that the jumpers are set properly.

**ICP DAS | ET-7000/PET-7000 Series**

Voltage/Current Input Selection Jumper Settings

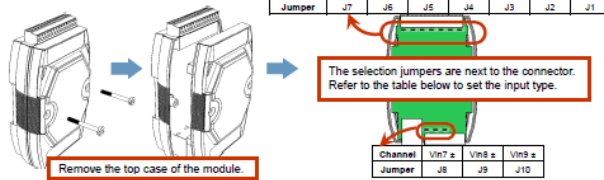

Channel	Vin6 ±	Vin5 ±	Vin4 ±	Vin3 ±	Vin2 ±	Vin1 ±	Vin0 ±
Jumper	J7	J6	J5	J4	J3	J2	J1

Channel	Vin7 ±	Vin8 ±	Vin9 ±
Jumper	J8	J9	J10

**ICP DAS | ET-7000/PET-7000 Series**

Modbus Register Table

Coils (0xxxx)

DEC	HEX	Points	
00162	00A2	:	
00181	00B5	:	Clear
00194	00C2	:	
00213	00D5	:	Clear
00226	00E2	1	Reset the
00239	00F9	1	
00255	0153	:	
00614	0266	:	Enable
00628	0274	1	
00629	0275	1	
			0277

For more detailed technical specifications related to the jumper settings for each ET-7X00/PET-7X00 module, please refer to “ET7000\_ET7200 Register Table”, which can be obtained from:

CD:\NAPDOS\ET7000\_ET7200\document\

- **Range**: In a manner, a different range can be set for each individual analog output channel. Select the required voltage/current range from the respective drop-down menus. For more detailed technical specifications related to the output range for each analog output channel, please refer to: "Appendix E. Analog Output Type and Data Format Table".
- **Slew Rate**: This is the programmable output slew rate for the analog output channels, i.e., the rate of change in the analog output voltage/current as it changes from one output voltage/current to another. Select the most appropriate value from the respective drop-down menus.
- **Power-on Value**: A power-on value can be set for a specific analog output channel, and the analog output channel will then generate the start-up value output.
- **Safe Value**: When communication between the Host PC and the ET-7X00/PET-7X00 module is interrupted, the analog output channels can generate a predefined safe value. This function can be enabled or disabled by configuring the Host WDT Timeout setting.

For a more detailed description of these Modbus functions, please refer to: "Appendix C. Modbus Application Notes".

## (E) Analog Input Settings

Analog Input Settings area contains two parts, the Basic Settings section and the Alarm Settings section, which will be described in detail below.

### Analog Input Settings

#### Basic Settings

Channel	Range (40427)	Enabled (00595)
Ch0	08, -10 V ~ 10 V	OFF <input type="radio"/> ON <input checked="" type="radio"/>
Ch1	08, -10 V ~ 10 V	OFF <input type="radio"/> ON <input checked="" type="radio"/>
Ch2	08, -10 V ~ 10 V	OFF <input type="radio"/> ON <input checked="" type="radio"/>
Ch3	08, -10 V ~ 10 V	OFF <input type="radio"/> ON <input checked="" type="radio"/>
Ch4	08, -10 V ~ 10 V	OFF <input type="radio"/> ON <input checked="" type="radio"/>
Ch5	08, -10 V ~ 10 V	OFF <input type="radio"/> ON <input checked="" type="radio"/>

Modbus Address	Function	Action
00628	Normal mode (16 bits and 10 Hz), Fast mode (12 bits and 60 Hz) for AI	OFF <input type="radio"/> ON <input checked="" type="radio"/> 0=Normal, 1=Fast (default=0)
00629	60/50 Hz Rejection	OFF <input type="radio"/> ON <input checked="" type="radio"/> 0=60 Hz, 1=50 Hz (default=0)
00631	Data Format	OFF <input type="radio"/> ON <input checked="" type="radio"/> 0=Hex, 1=Engineering (default=0)
00632	Restore Analog Calibration to Factory Settings	<input type="checkbox"/>

## Tips & Warnings



Before selecting the input range for each analog input channel, make sure that the jumpers are set properly.

**ICP DAS | ET-7000/PET-7000 Series**

Voltage/Current Input Selection Jumper Settings

Channel	Vin6 ±	Vin5 ±	Vin4 ±	Vin3 ±	Vin2 ±	Vin1 ±	Vin0 ±
Jumper	J7	J6	J5	J4	J3	J2	J1

Channel	Vin7 ±	Vin8 ±	Vin9 ±
Jumper	J8	J9	J10

Voltage Input (Differential Mode)

Voltage Input (Single-ended Mode)

**ICP DAS | ET-7000/PET-7000 Series**

Modbus Register Table

Coils (0xxxx)

DEC	HEX	Points	Comment
00162	00A2	:	
00181	00B5	20	Clear
00194	00C2	:	
00213	00D5	20	Clear
00226	00E2	1	Reset the
00233	00E9	1	
00595	0253	:	
00614	0266	20	Enable
00628	0274	1	
00629	0275	1	
0277			

For more detailed technical specifications related to the jumper settings for each ET-7X00/PET-7X00 module, please refer to “ET7000\_ET7200 Register Table”, which can be obtained from:

CD:\NAPDOS\ET7000\_ET7200\document\

- **Range:** ET-7X00/PET-7X00 modules provide a programmable input voltage/current range on all analog inputs channels, where a different range can be set for each individual analog input channel. Select the required voltage/current from the respective drop-down menus. For more detailed technical specifications related to the input range for each analog input channel, please refer to: “Appendix D. Analog Input Type and Data Format Table”.
- **Enable:** This section allows each analog input channel to be switched ON or OFF.  
**Normal/Fast Mode:** ET-7X00/PET-7X00 modules support sample rates in either “Normal” or “Fast” mode. Fast mode uses 60 Hz with a 12-bit resolution, while Normal mode uses 10 Hz with a 16-bit resolution.
- **50/60Hz Rejection for AI:** In order to remove the noise from the power supply, ET-7X00/PET-7X00 analog input modules feature two built-in rejection filters, that operate at different frequencies, 50 or 60 Hz, that are designed to remove noise generated by different power supplies.
- **AI Data Format:** ET-7X00/PET-7X00 modules allow data to be displayed in either hexadecimal or engineering unit format. For more detailed technical specifications related to the data format for each analog input channel, please refer to: “Appendix D. Analog Input Type and Data Format Table”.

## (F) Analog Input Alarm Settings

The ET-7X00/PET-7X00 modules feature a built-in alarm function. The alarm includes two parts, the high alarm and the low alarm and each need to be configured for a specific channel.

**Alarm Settings**

Channel	High Alarm			Low Alarm		
	Value (40296)	Enabled (00636)	Type (00700)	Value (40328)	Enabled (00668)	Type (00732)
Ch0	<input type="text" value="10.000"/> +/-10 V	OFF <input checked="" type="radio"/> ON <input type="radio"/>	0 - Momentar <input type="button" value="v"/>	<input type="text" value="-10.000"/> +/-10 V	OFF <input checked="" type="radio"/> ON <input type="radio"/>	0 - Momentar <input type="button" value="v"/>
Ch1	<input type="text" value="10.000"/> +/-10 V	OFF <input checked="" type="radio"/> ON <input type="radio"/>	0 - Momentar <input type="button" value="v"/>	<input type="text" value="-10.000"/> +/-10 V	OFF <input checked="" type="radio"/> ON <input type="radio"/>	0 - Momentar <input type="button" value="v"/>
Ch2	<input type="text" value="10.000"/> +/-10 V	OFF <input checked="" type="radio"/> ON <input type="radio"/>	0 - Momentar <input type="button" value="v"/>	<input type="text" value="-10.000"/> +/-10 V	OFF <input checked="" type="radio"/> ON <input type="radio"/>	0 - Momentar <input type="button" value="v"/>
Ch3	<input type="text" value="10.000"/> +/-10 V	OFF <input checked="" type="radio"/> ON <input type="radio"/>	0 - Momentar <input type="button" value="v"/>	<input type="text" value="-10.000"/> +/-10 V	OFF <input checked="" type="radio"/> ON <input type="radio"/>	0 - Momentar <input type="button" value="v"/>
Ch4	<input type="text" value="10.000"/> +/-10 V	OFF <input checked="" type="radio"/> ON <input type="radio"/>	0 - Momentar <input type="button" value="v"/>	<input type="text" value="-10.000"/> +/-10 V	OFF <input checked="" type="radio"/> ON <input type="radio"/>	0 - Momentar <input type="button" value="v"/>
Ch5	<input type="text" value="10.000"/> +/-10 V	OFF <input checked="" type="radio"/> ON <input type="radio"/>	0 - Momentar <input type="button" value="v"/>	<input type="text" value="-10.000"/> +/-10 V	OFF <input checked="" type="radio"/> ON <input type="radio"/>	0 - Momentar <input type="button" value="v"/>

Note: By default, the Alarm function is disabled and the Alarm Type is set to momentary.

- **Value:** You can define both the high alarm value and the low alarm value using the Alarm Value text box. When the analog input value is higher than the high alarm value, or lower than the low alarm value, an alarm occurs. The alarm status will then be activated and switched to on.
- **Enable:** Each analog input alarm can be switched to on or off by clicking the appropriate radio button.
- **Mode:** The ET-7X00/PET-7X00 allows the alarm to be selected as either Momentary or Latch mode, which can be set using the Mode combo box for both the low alarm and the high alarm.
  - **Latch Mode:** Once an alarm occurs, the alarm status will be activated and set to the logic high level. This value will remain until the alarm is cleared manually.
  - **Momentary Mode:** In this mode, the alarm status will dynamically change depending on whether or not an alarm has occurred. If an alarm occurs, the alarm status will be set to on. If the alarm is deactivated, the alarm status will be set to off.

## 3.3. Authentication

The “Authentication” section of the Main Menu contains the following options:

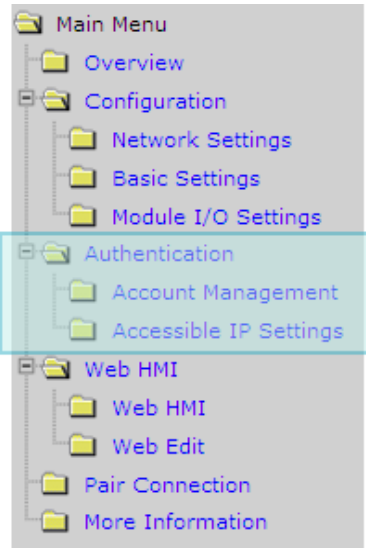

### **Account Management:**

Provides access to the privilege management page, which allows you to manage user accounts and their associated privileges.

### **Accessible IP Settings:**

Provides access to the IP Filter Settings page, which allows you to control access to the web site.

### 3.3.1. Account Management

The Account Management page provides functions that allow the following tasks to be performed:

- (A) Configuration of user accounts
- (B) Restoration of the factory default user account

No.	Account	Password	Verify Password	Authority	Enabled
1	Admin	****	****	Admin	On
2				Admin	<input type="checkbox"/>
3				Admin	<input type="checkbox"/>
4				Admin	<input type="checkbox"/>
5				Admin	<input type="checkbox"/>

**Account:** (Maximum of 8 characters)  
**Password:** (Maximum of 8 characters)

Load Setup Default

## (A) Configuring the User Accounts

The ET-7X00/PET-7X00 interface supports a maximum of five user accounts, including:

- A Built-in Administrator Account

The built-in Administrator account is basically a setup and disaster recovery account that can be deleted. You can, however, change the password for the administrator account.

- Four User-defined Accounts

Each user account consists of an account name, a password and an authority level. The authority level includes the following roles, which determine the type of operations the user is allowed to perform.

- **Admin:** This level enables access to all ET-7X00/PET-7X00 web site features, functions, and commands.
- **User:** This level enables limited access to the ET-7X00/PET-7X00 web site features, functions, and commands. In general, operators at this level cannot change configuration settings.

Once a user account has been created, it can be either enabled or disabled.

The screenshot shows the 'Account Management' interface. It features a table with the following columns: No., Account, Password, Verify Password, Authority, and Enabled. The table contains five rows. The second row (No. 2) is highlighted with a blue box and labeled with a '1' in a blue circle. The 'Account' field for this row contains 'USER1', the 'Password' and 'Verify Password' fields contain four asterisks, and the 'Authority' dropdown is set to 'User'. The 'Enabled' checkbox for this row is checked. Below the table, there is a 'Submit' button, which is also highlighted with a blue box and labeled with a '2' in a blue circle. At the bottom of the interface, there are two lines of text: 'Account: (Maximum of 8 characters)' and 'Password: (Maximum of 8 characters)'.

No.	Account	Password	Verify Password	Authority	Enabled
1	Admin	****	****	Admin	<input type="checkbox"/>
2	USER1	****	****	User	<input checked="" type="checkbox"/>
3				Admin	<input type="checkbox"/>
4				Admin	<input type="checkbox"/>
5				Admin	<input type="checkbox"/>

Submit

Account: (Maximum of 8 characters)  
Password: (Maximum of 8 characters)

To add a new user account, perform the followings:

**Step 1 :** Enter the user account information into the relevant text fields, and then select the “**Enable**” checkbox.

**Step 2 :** Click the “**Submit**” button to complete the user account configuration and save the details.



## (B) Restoring the Factory Default User Accounts

The ET-7X00/PET-7X00 has a built-in administrator account named **Admin** that is created by default. The default account cannot be deleted.



To restore the factory default user accounts, perform the followings:

**Step 1** : Select the “**Load Setup Default**” checkbox.

**Step 2** : Click the “**Submit**” button to restore the factory default user accounts.

### 3.3.2. Accessible IP Settings

The IP Filter Settings page provides functions that allow the following tasks to be performed:

- Configuration of the connection filtering

**IP Filter Settings**

Enable the IP filter table. (Note: By leaving this unchecked, the filter table will be "Disabled", which will allow connection requests from all IPs.)

IP address for the browser PC is: 10.1.0.25

No.	Activate	From (IP Address)	To (IP Address)
1	<input type="checkbox"/>	<input type="text"/>	<input type="text"/>
2	<input type="checkbox"/>	<input type="text"/>	<input type="text"/>
3	<input type="checkbox"/>	<input type="text"/>	<input type="text"/>
4	<input type="checkbox"/>	<input type="text"/>	<input type="text"/>
5	<input type="checkbox"/>	<input type="text"/>	<input type="text"/>
6	<input type="checkbox"/>	<input type="text"/>	<input type="text"/>

## (A) Configuring IP Filter

The ET-7X00/PET-7X00 includes an IP filter that enables you to restrict or grant user access based on a custom IP filter list that you create.

The filter can be enabled by selecting the “**Enable the IP filter table**” checkbox. After this option is selected, only requests from the IP addresses included in the list will be allowed access to the module.

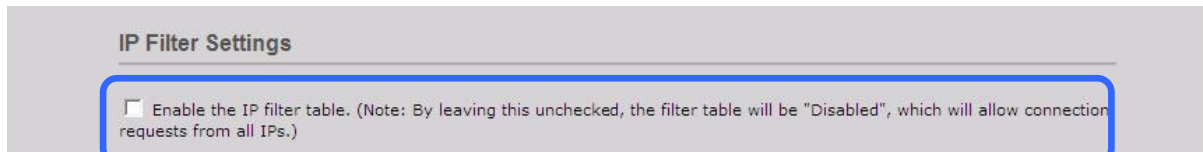

IP Filter Settings

Enable the IP filter table. (Note: By leaving this unchecked, the filter table will be "Disabled", which will allow connection requests from all IPs.)

### Tips & Warnings



By default, there is no restriction on outgoing access.

Each filter list entry can be either activated or deactivated by selecting the respective “**Activate the Rule**” checkbox.

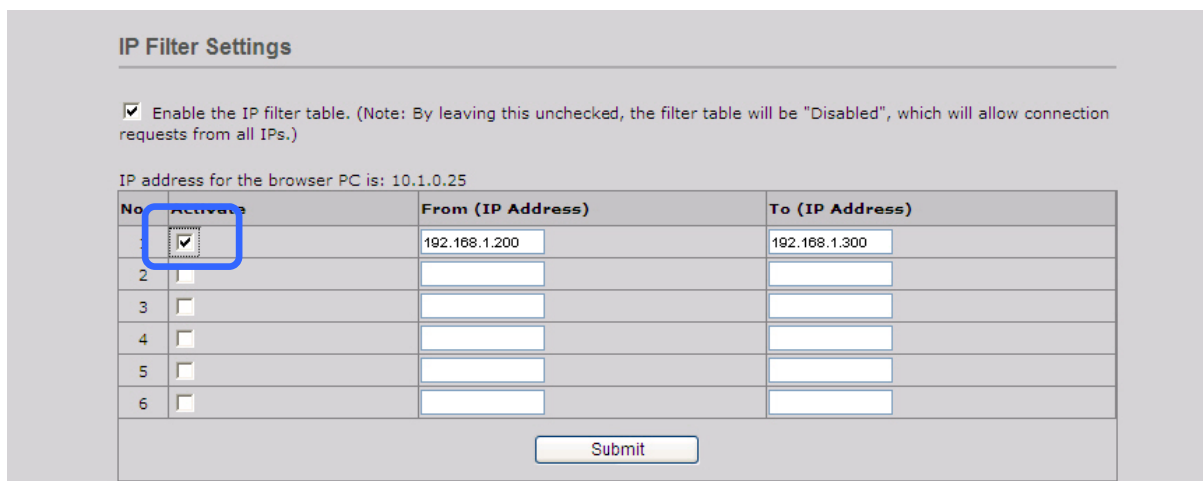

IP Filter Settings

Enable the IP filter table. (Note: By leaving this unchecked, the filter table will be "Disabled", which will allow connection requests from all IPs.)

IP address for the browser PC is: 10.1.0.25

No.	Activate	From (IP Address)	To (IP Address)
1	<input checked="" type="checkbox"/>	192.168.1.200	192.168.1.300
2	<input type="checkbox"/>		
3	<input type="checkbox"/>		
4	<input type="checkbox"/>		
5	<input type="checkbox"/>		
6	<input type="checkbox"/>		

Submit

## (B) Configuring the IP Filters

Two methods are provided for configuring the IP filter, allowing filtering for either individual IP addresses, or across a range (group) of IP addresses.

### Method 1: Allow access from a single IP address

IP Filter Settings

Enable the IP filter table. (Note: By leaving this unchecked, the filter table will be "Disabled", which will allow connection requests from all IPs.)

IP address for the browser PC is: 10.1.0.25

No.	Activate	From (IP Address)	To (IP Address)
1	<input checked="" type="checkbox"/>	10.1.0.25	10.1.0.25
2	<input type="checkbox"/>		
3	<input type="checkbox"/>		
4	<input type="checkbox"/>		
5	<input type="checkbox"/>		
6	<input type="checkbox"/>		

Submit

**Step 1** : Select the “Enable the IP filter table” checkbox.

**Step 2** : Enter the same IP address in both the “From (IP Address)” and the “To (IP Address)” text boxes. (The IP address may be the address of the PC currently being used or others)

**Step 3** : Select the “Activate the Rule” checkbox.

**Step 4** : Click the “Submit” button to complete the configuration of the IP filter list and save the settings.

## Method 2: Allow access from a group of IP addresses

The screenshot shows the 'IP Filter Settings' form. At the top, there is a checkbox labeled 'Enable the IP filter table.' with a note: '(Note: By leaving this unchecked, the filter table will be "Disabled", which will allow connection requests from all IPs.)'. Below this, it says 'IP address for the browser PC is: 10.1.0.25'. There is a table with columns: 'No.', 'Activate', 'From (IP Address)', and 'To (IP Address)'. The first row has '1' in the 'No.' column, a checked checkbox in the 'Activate' column, '10.1.0.20' in the 'From (IP Address)' column, and '10.1.0.30' in the 'To (IP Address)' column. Below the table is a 'Submit' button.

No.	Activate	From (IP Address)	To (IP Address)
1	<input checked="" type="checkbox"/>	10.1.0.20	10.1.0.30
2	<input type="checkbox"/>		
3	<input type="checkbox"/>		
4	<input type="checkbox"/>		
5	<input type="checkbox"/>		
6	<input type="checkbox"/>		

**Step 1** : Select the “Enable the IP filter table” checkbox

**Step 2** : Enter the first IP address in the range in the “From (IP Address)” and enter the final IP address in the range in the “To (IP Address)” text boxes.

**Step 3** : Select the “Activate the Rule” checkbox.

**Step 4** : Click the “Submit” button to complete the configuration of the IP filter list and save the settings.

## 3.4. Web HMI

The “**Web HMI**” section of the Main Menu contains the following options:

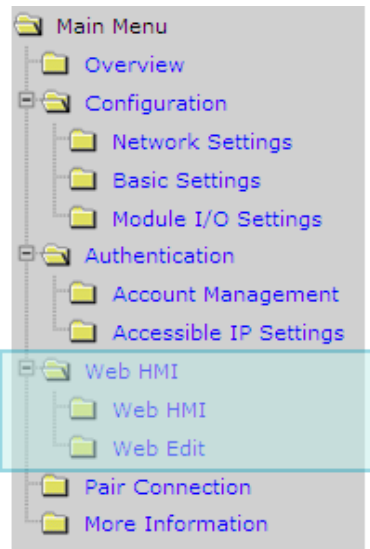

### **Web HMI:**

Provides access to the I/O monitor page, which allows you to remotely monitor and control the I/O status of the ET-7X00/PET-7X00 module.

### **Web Edit:**

Provides access to the Web interface Configuration page, which allows you to create dynamic web HMI pages.

### 3.4.1. Web HMI

The ET-7X00/PET-7X00 module features a Web HMI web interface that can be used to display real-time I/O data values and alarms via the LAN or the Internet. Real-time I/O data values and alarms can be monitored at either the local or remote site using any web browser. Then, the Web HMI is completed immediately without requiring any programming skills.

The screenshot displays the Web HMI interface for the ET-7X00/PET-7X00 module. The interface is divided into a left-hand navigation menu and a main content area. The navigation menu includes options like 'Main Menu', 'Overview', 'Configuration', 'Authentication', and 'Web HMI'. The 'Web HMI' folder is expanded, showing sub-options like 'Web Edit', 'Pair Connection', and 'More Information'. The main content area is titled 'Analog Input' and features a tabbed interface with 'AI', 'AO', 'DI', and 'DO' tabs. The 'AI' tab is active, displaying three tables: 'Analog Input', 'High/Low Latched Value for Analog Inputs', and 'High/Low Alarm Status for Analog Inputs'. Each table provides detailed data for five analog input channels (AI0 to AI5), including register addresses, values in hex and floating point formats, and alarm status.

No	Register	Value	
		Hex Format	Floating Format
AI0	30000	FFFF	-0.000
AI1	30001	FFFF	-0.000
AI2	30002	0000	0.000
AI3	30003	0000	0.000
AI4	30004	FFFF	-0.000
AI5	30005	FFFF	-0.000

No	Latched High			Latched Low		
	Register	Value Hex Format	Floating Format	Register	Value Hex Format	Floating Format
AI0	30236	0005	0.001	30268	FFFB	-0.001
AI1	30237	0003	0.000	30269	FFFA	-0.001
AI2	30238	0006	0.001	30270	FFFA	-0.001
AI3	30239	0006	0.001	30271	FFFB	-0.001
AI4	30240	0004	0.001	30272	FFFA	-0.001
AI5	30241	0004	0.001	30273	FFFC	-0.001

No	High Alarm			Low Alarm		
	Register	Value	Status	Register	Value	Status
AI0	10224	10.000	OFF	10256	-10.000	OFF

### 3.4.2. Web Edit

The ET-7X00/PET-7X00 module provides functions that enable users to create customized web pages. Users can upload specific I/O layout diagrams in either bmp, jpg, or gif format and can define a description for each I/O point. No HTML or Java skills are required in order to create the web pages.



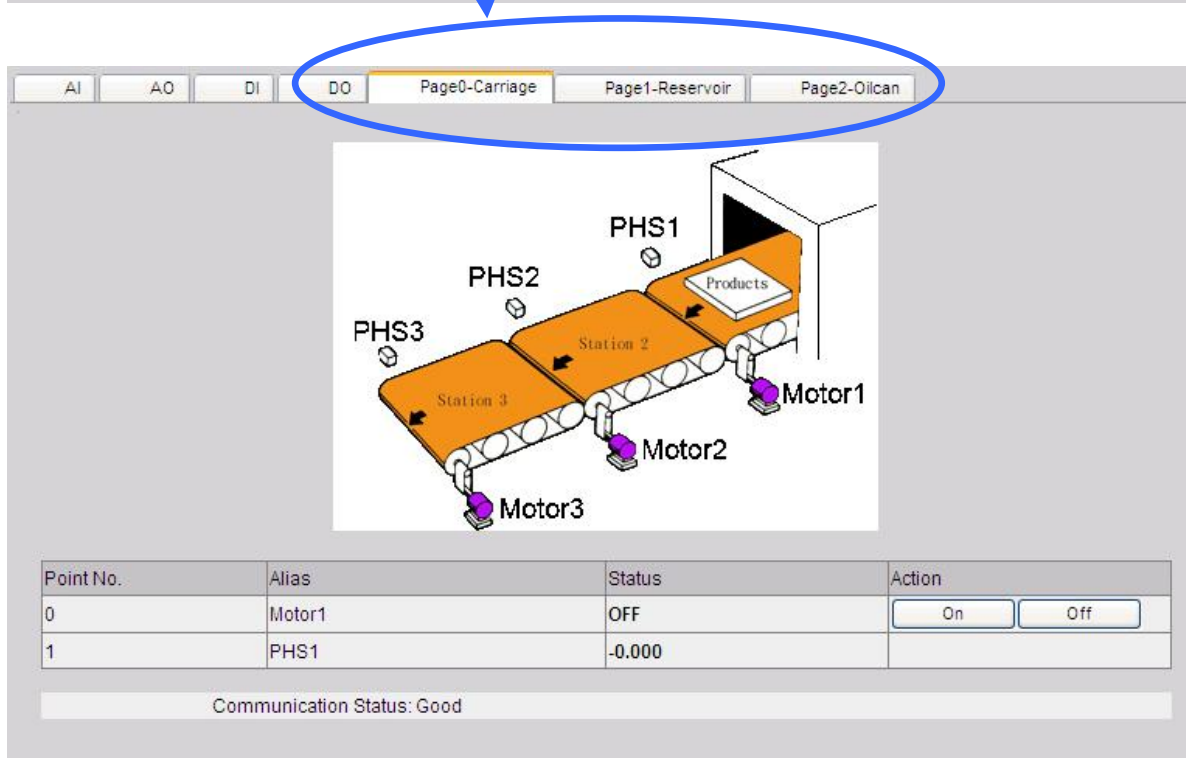
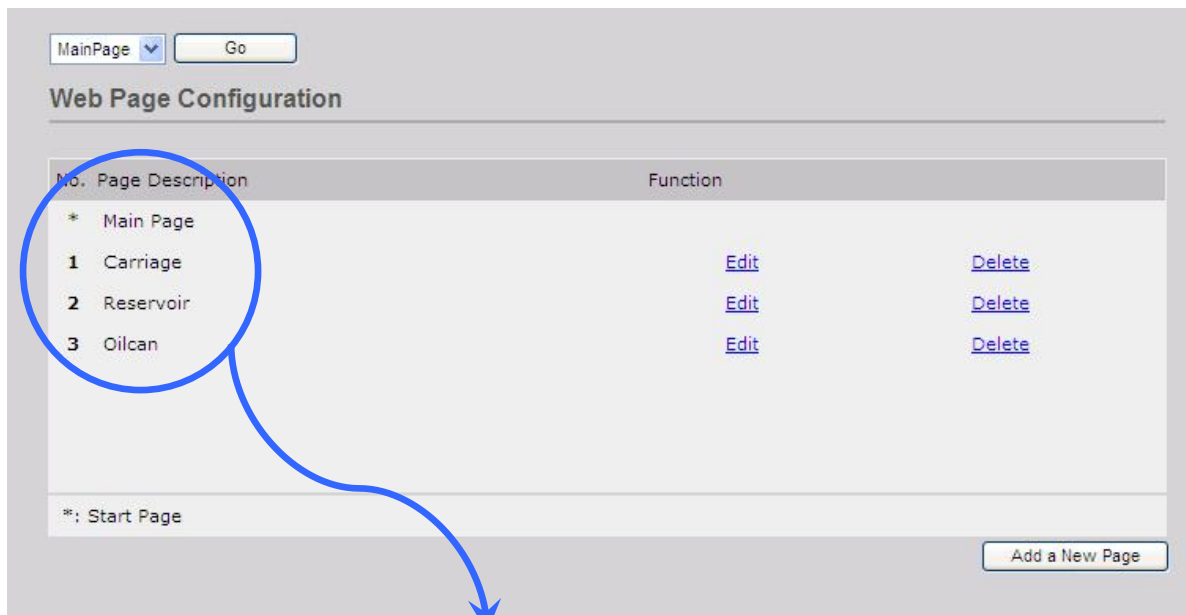

By default, no pages are listed on the initial “**Web Page Configuration**” page.

The ET-7X00/PET-7X00 Web Edit function allows the creation of up to 10 user-defined web pages.

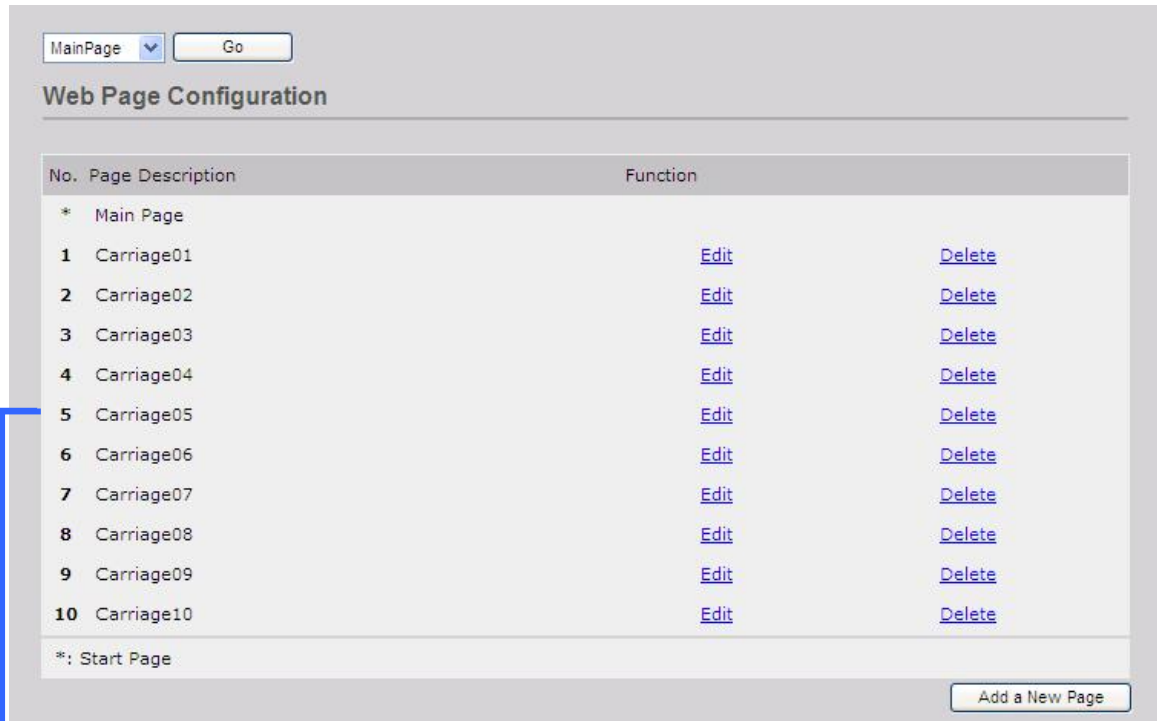

The screenshot shows a web interface titled "Web Page Configuration". At the top left, there is a dropdown menu set to "MainPage" and a "Go" button. Below the title is a table with two columns: "No." and "Page Description". The table contains 10 rows, numbered 1 to 10, each with a "Page Description" of "Carriage01" through "Carriage10". To the right of the table, under the "Function" column, there are two columns of buttons: "Edit" and "Delete". A blue arrow points from the number "10" in the table to a callout box below. At the bottom right of the interface is a button labeled "Add a New Page".

No.	Page Description	Function
*	Main Page	
1	Carriage01	<a href="#">Edit</a> <a href="#">Delete</a>
2	Carriage02	<a href="#">Edit</a> <a href="#">Delete</a>
3	Carriage03	<a href="#">Edit</a> <a href="#">Delete</a>
4	Carriage04	<a href="#">Edit</a> <a href="#">Delete</a>
5	Carriage05	<a href="#">Edit</a> <a href="#">Delete</a>
6	Carriage06	<a href="#">Edit</a> <a href="#">Delete</a>
7	Carriage07	<a href="#">Edit</a> <a href="#">Delete</a>
8	Carriage08	<a href="#">Edit</a> <a href="#">Delete</a>
9	Carriage09	<a href="#">Edit</a> <a href="#">Delete</a>
10	Carriage10	<a href="#">Edit</a> <a href="#">Delete</a>

\*: Start Page

Add a New Page

**A maximum of 10 pages can be created**

Below is an example of how to create a customized web page.

## Example

Objective:

Create a Web page to monitor the I/O status of a conveyor system, as shown below. The I/O system contains a sensor that is used to detect the products, and a switch that is used to turn the conveyor motor on and off.

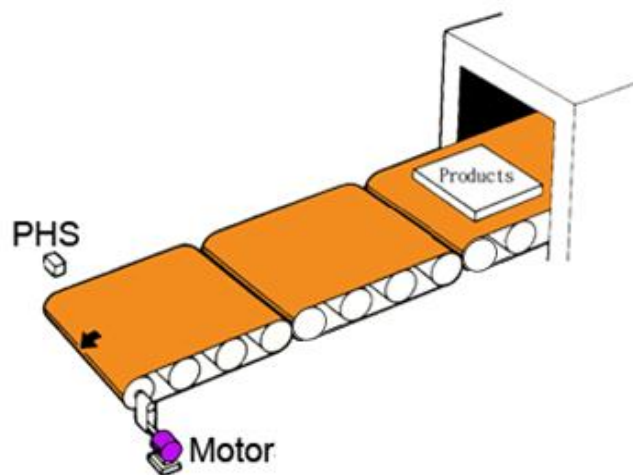

### Step 1 : Add a New Page

Click the “Add a new Page” button to begin creating a new page.

MainPage

### Web Page Configuration

No.	Page Description	Function
*	Main Page	

\*: Start Page

## Step 2 : Upload an Image

Click the “**Browse...**” button to select an image, and then click the “**Upload**” button to upload the image to the ET-7X00/PET-7X00 module, as shown in the figure below.

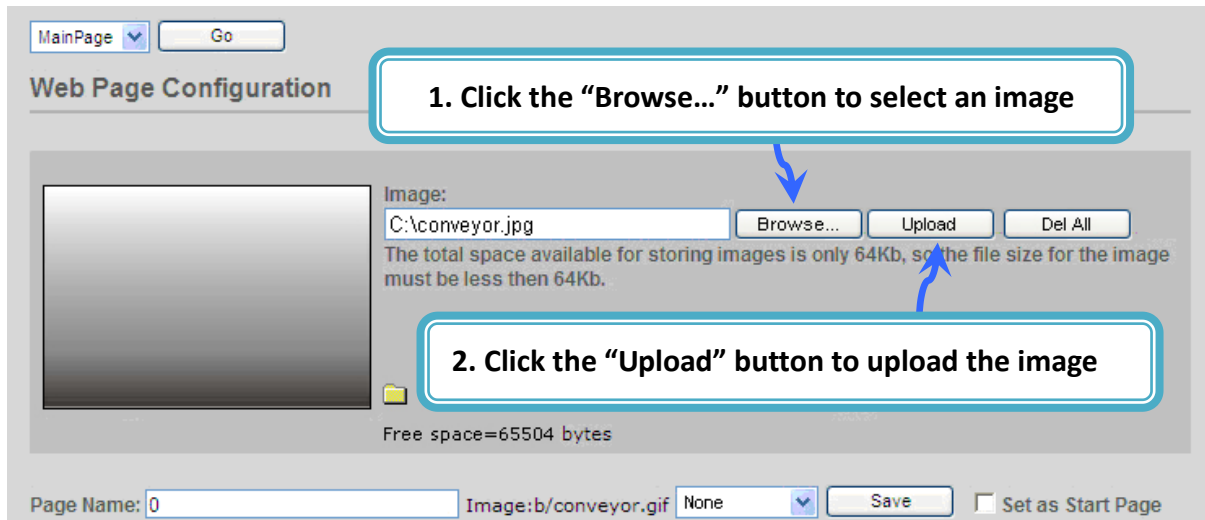

## Tips & Warnings



The image can be in either .jpg, .gif, or .bmp format with a maximum file size of 64 kb. The recommended resolution for the image to be displayed on the editing Web page is 340 \* 250 pixels.

After the upload is completed, the image information will be displayed and the image will be added to the “Image” dropdown list box, as shown below.

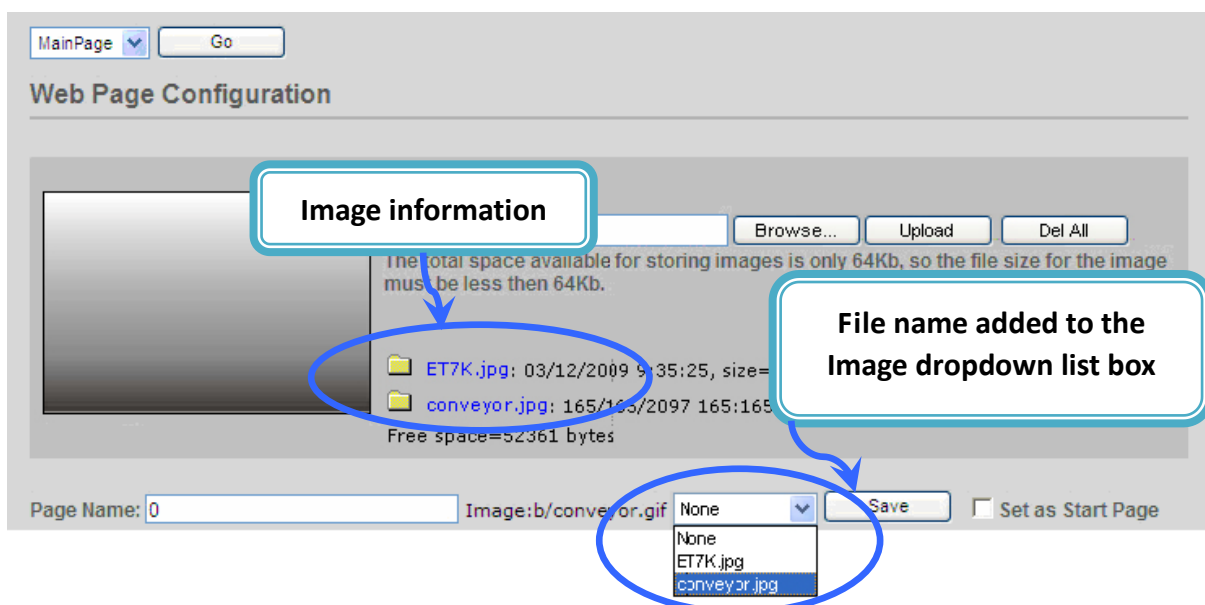

### Step 3 : Set the Page Name and Select the Image

Enter a name for the page in the “Page Name” field and then select an image from the “Image” dropdown list box. After selecting the image, it will be displayed in the preview window.

### Step 4 : Add the Register Item(s) that are to be used to read the selected sensor input

Click the “Edit” button from the first row in the Group table, and the “Edit Group Register” window will be displayed.

The screenshot displays the 'Web Page Configuration' interface. At the top, there is a 'MainPage' dropdown menu and a 'Go' button. Below this, the 'Image:' section includes a 'Browse...' button, an 'Upload' button, and a 'Del All' button. A preview window on the left shows a conveyor belt with 'Products' and a 'Motor'. A text box with a blue border and arrow points to the 'Image:' field with the text: 'Enter a name for the page and select an image'. Below the preview, a list of files is shown: 'ET7K.jpg' (03/12/2009 9:35:25, size=6866 bytes) and 'conveyor.jpg' (165/165/2097 165:165:85, size=13111 bytes). The 'Page Name:' field contains 'Carriage' and the 'Image:' dropdown is set to 'conveyor.jpg'. A blue oval highlights the 'Page Name' and 'Image' fields. Below this, the 'Group' table is visible. The table has columns: Register, Alias, Scaling, Type, Datatype, and buttons for 'Edit' and 'Clear'. The first row (Register 1) has an 'Edit' button circled in blue. A blue arrow points from a text box at the bottom to this 'Edit' button. The text box contains: 'Click the “Edit” button to enter or modify the details of the register item(s)'. The table data is as follows:

Register	Alias	Scaling	Type	Datatype	Buttons
1					Edit, Clear
2					Edit, Clear
3					Edit, Clear

**Step 5 : Add a DI value that is to be used to read “PHS” input**

Set the PHS as an input (use the **Modbus Register 0 (DIO)**), and then select **Discrete Input** as the **Register Type** and enter the name **PHS1** as the **Alias**, as per the figure shown below.

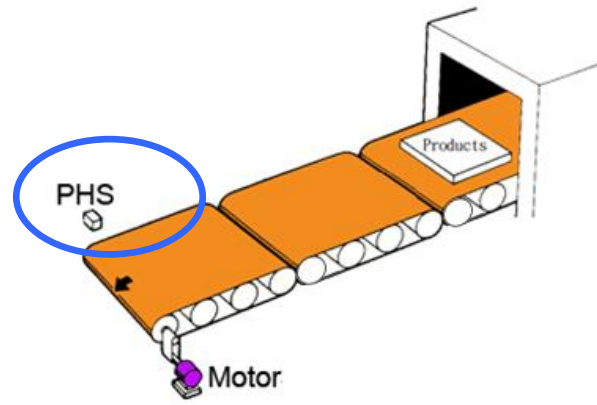
A screenshot of a web interface titled 'Edit Group Register'. At the top left, there is a 'MainPage' dropdown menu and a 'Go' button. The interface has four rows: 'Modbus Register', 'Alias', 'Scaling', and 'Register Type'. The 'Modbus Register' field contains 'DIO' (highlighted with a blue box). The 'Protocol Address (Base 0)' dropdown is set to '0'. The 'Alias' field contains 'PHS1'. The 'Scaling' section has a 'Disabled' dropdown and a '0' input field. The 'Register Type' dropdown is open, showing options: 'Discrete Input', 'Coil', 'Discrete Input', 'Input', and ' Holding'. The 'Discrete Input' option is highlighted with a blue arrow pointing from the 'DIO' box. A 'Save' button is visible at the bottom right of the form.

**Step 6 : Save the selected sensor settings**

Click the “**Save**” button to complete the setup and save the register settings.

A screenshot of the same 'Edit Group Register' web interface. The 'Modbus Register' field still contains 'DIO'. The 'Protocol Address (Base 0)' dropdown is set to '0'. The 'Alias' field contains 'PHS1'. The 'Scaling' section has a 'Disabled' dropdown and a '0' input field. The 'Register Type' dropdown is set to 'Discrete Input'. The 'Save' button at the bottom right is now highlighted with a blue circle.

**Step 7 : Add the register item(s) that is to be used to write the selected motor output**

After saving the register settings, the new register item will be displayed in the Group table.

If you wish to edit the details for an item, click the “Edit” button to access the Edit Group Register page.

Group						
	Register	Alias	Scaling	Type	Data type	
1	0	PHS1	0	Discrete Input	Boolean	<input type="button" value="Edit"/> <input type="button" value="Clear"/>
2						<input type="button" value="Edit"/> <input type="button" value="Clear"/>
3						<input type="button" value="Edit"/> <input type="button" value="Clear"/>

**Click the “Edit” button to enter or modify the details of the register item(s)**

MainPage

### Edit Group Register

Modbus Register Protocol Address (Base 0)

Alias The maximum length for the alias is 8 characters

Scaling Disabled   
Scaled value = (A/D value) \* Gain  
Gain ranges from 0.01 to 655.35

Register Type Discrete Input

If you wish to delete a register item, click the “Clear” button.

Group						
	Register	Alias	Scaling	Type	Data type	
1	0	PHS1	0	Discrete Input	Boolean	<input type="button" value="Edit"/> <input type="button" value="Clear"/>
2						<input type="button" value="Edit"/> <input type="button" value="Clear"/>
3						<input type="button" value="Edit"/> <input type="button" value="Clear"/>

**Step 8 : Add a DO that is to be used to write the “Motor” out put to turn the conveyor motor on and off**

Set the Motor as an output (use the **Modbus Register 0 (DO0)**), and then select **Coil** and **Write** as the **Register Type** and enter **Motor** as the **Alias**, as shown in the figure below.

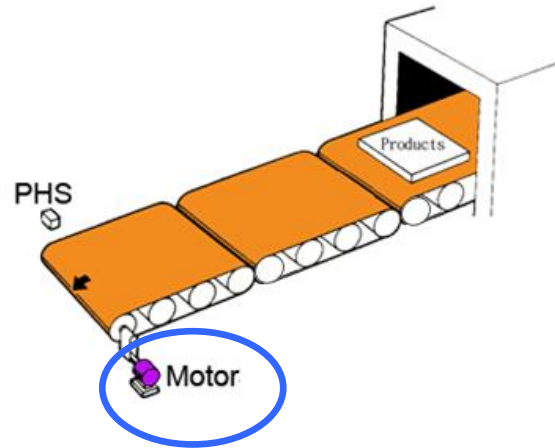
A screenshot of a web interface titled 'Edit Group Register'. It features a table with four rows: 'Modbus Register', 'Alias', 'Scaling', and 'Register Type'. The 'Modbus Register' field contains 'DO0'. The 'Alias' field contains 'Motor'. The 'Scaling' field is set to 'Disabled' with a value of '0'. The 'Register Type' field is set to 'Coil' and 'Write'. A 'Save' button is at the bottom right. A blue box highlights the 'DO0' field, with arrows pointing to the 'Motor' alias, the 'Write' dropdown, and the 'Save' button. A text box at the bottom explains that selecting 'write' as the Register type will show a control button on the web page.

By selecting “write” as the Register type, control button will be shown on the web page. (Refer to Step 10)

**Step 9 : Save the selected sensor settings**

Click the “**Save**” button to complete setup and save the register settings.

A screenshot of the same 'Edit Group Register' web interface as in Step 8. The settings are identical, but the 'Save' button at the bottom right is now highlighted with a blue circle, indicating it should be clicked to save the settings.

## Step 10 : Browse the “Carriage” web page

After saving the editing page, a page named **Carriage** has been added to the list box on the top left-hand side of the **Web Page Configuration** window. Select the **Carriage** item and click the “Go” button to display to the **Carriage** web page.

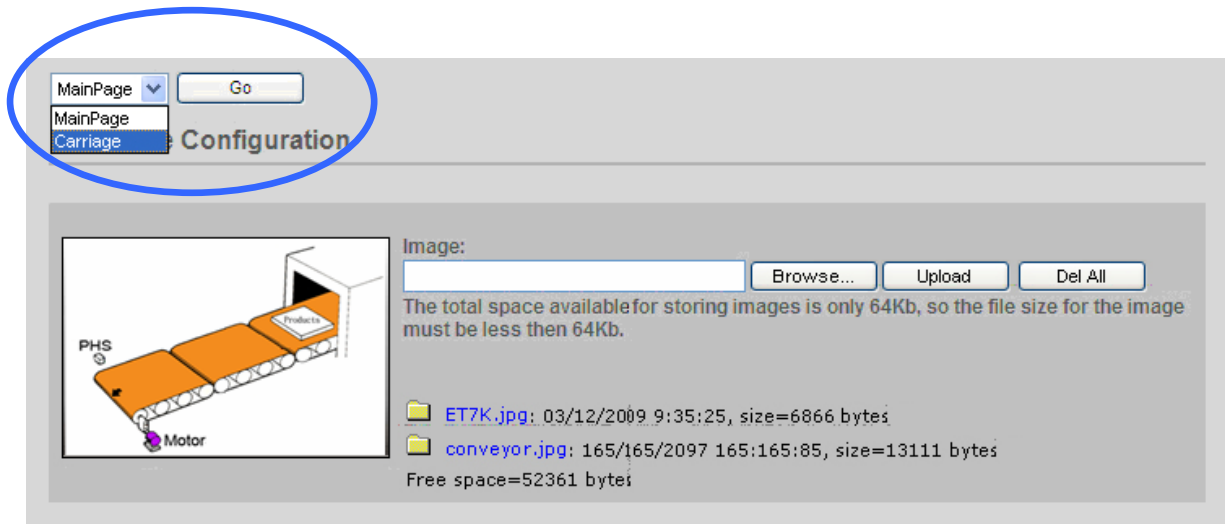

The conveyor image file and the newly created register items will be displayed on the **Carriage** web page, including control buttons that can be used to switch the motor for the conveyor on or off.

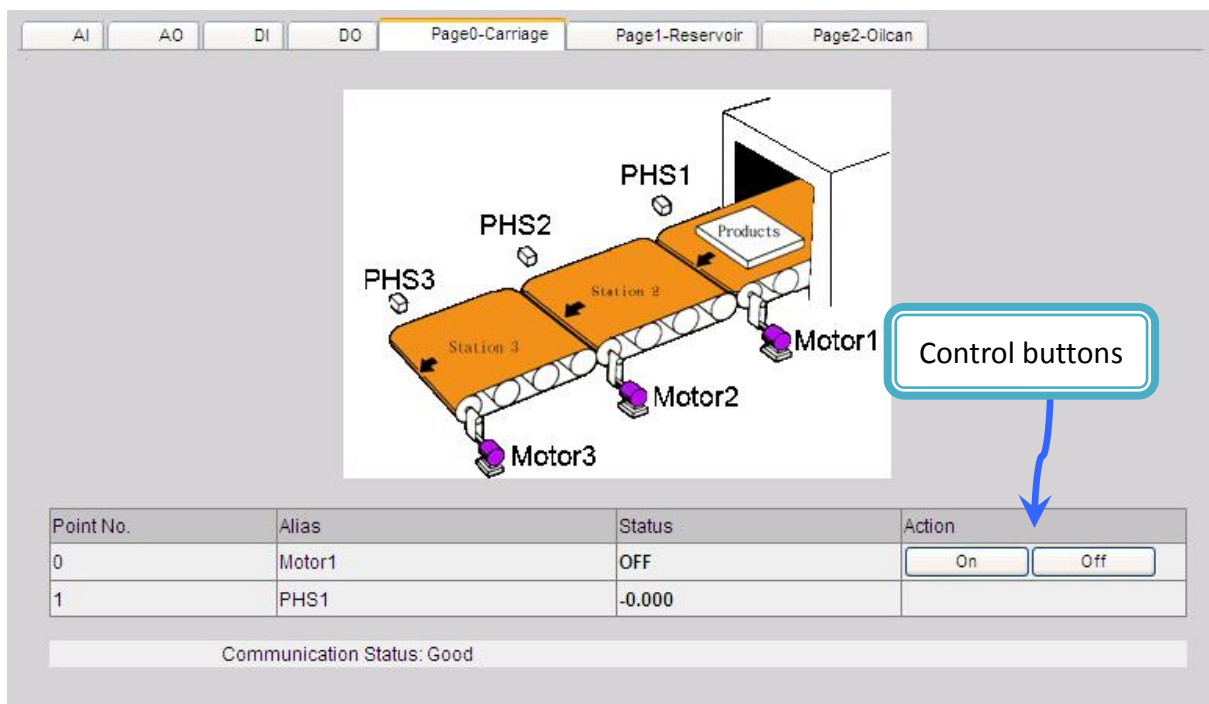



## 3.5. I/O Pair Connection

The “**Pair Connection**” option in the Main Menu provides access to the configuration page for the pair connection function.



The pair connection function is a particular feature of the ET-7X00/PET-7X00 module that can be used to enable a pair of DI-to-DO (AI-to-AO) via Modbus/TCP. With the pair connection function enabled, the ET-7X00/PET-7X00 module can poll the status of remote input devices using the Modbus/TCP protocol and then continuously write to its output channels in the background.

The Pair Connection function consists of the following parameters:

Modbus Settings			
Modbus Port	<input type="text" value="502"/>		
<input type="checkbox"/> <b>I/O Pair Connection</b>			
Remote IP Address	<input type="text"/>	Remote TCP Port	<input type="text" value="0"/>
Connection Timeout	<input type="text" value="0"/> ms	Reconnect Interval	<input type="text" value="0"/> ms
Remote NetID	<input type="text" value="0"/>	Scan Time	<input type="text" value="0"/> ms
Access Type	DO <input type="checkbox"/>		
Local DO Base Address	<input type="text" value="0"/>	Remote DI Base Address	<input type="text" value="0"/>
I/O Count	<input type="text" value="0"/>	Communication Timeout	<input type="text" value="0"/> ms
Access Type	AO <input type="checkbox"/>		
Local AO Base Address	<input type="text" value="0"/>	Remote AI Base Address	<input type="text" value="0"/>
I/O Count	<input type="text" value="0"/>	Communication Timeout	<input type="text" value="0"/> ms
<input type="button" value="Submit"/>			

**I/O Pair Connection**: This item is used to enable/disable the I/O pair connection.

**Remote IP Address**: The IP address of the remote input device.

**Remote TCP Port**: The Modbus/TCP Port of the remote input device.

**Connection Timeout**: The length of time that the ET-7X00/PET-7X00 module should wait for a connection to the remote input device.

**Reconnect Interval**: The reconnect interval is the amount of time between attempts by the ET-7X00/PET-7X00 module to reconnect with the remote input device.

**Remote Net ID**: The Modbus Net ID of the remote device.

**Scan Time**: The frequency that the remote input device will be polled.

**Access Type**: Enable/Disable the DI-to-DO (AI-to-AO) pair connection.

**Local DO Base Address**: The DO base address of the local DO register that will be mapped to the remote DI device.

**Remote DI Base Address**: The DI base address of the Remote DI device that will be mapped to the local DO register.

**I/O Count**: The I/O count mapped from the base address.

**Communication Timeout**: The period of time that the ET-7X00/PET-7X00 module will wait for a response from the remote DI device.

### 3.5.1. Example 1: Pair Connection - AO to AI

In this example, we will show how to use this feature to achieve AI/AO mapping on two remote I/O devices.

#### Hardware devices:

PET-7026 (AIO/DIO module), ET-7017 (AI/DO module), PoE Switch, Power Supply (24 V), Power Supply (48 V).

#### Hardware Connections:

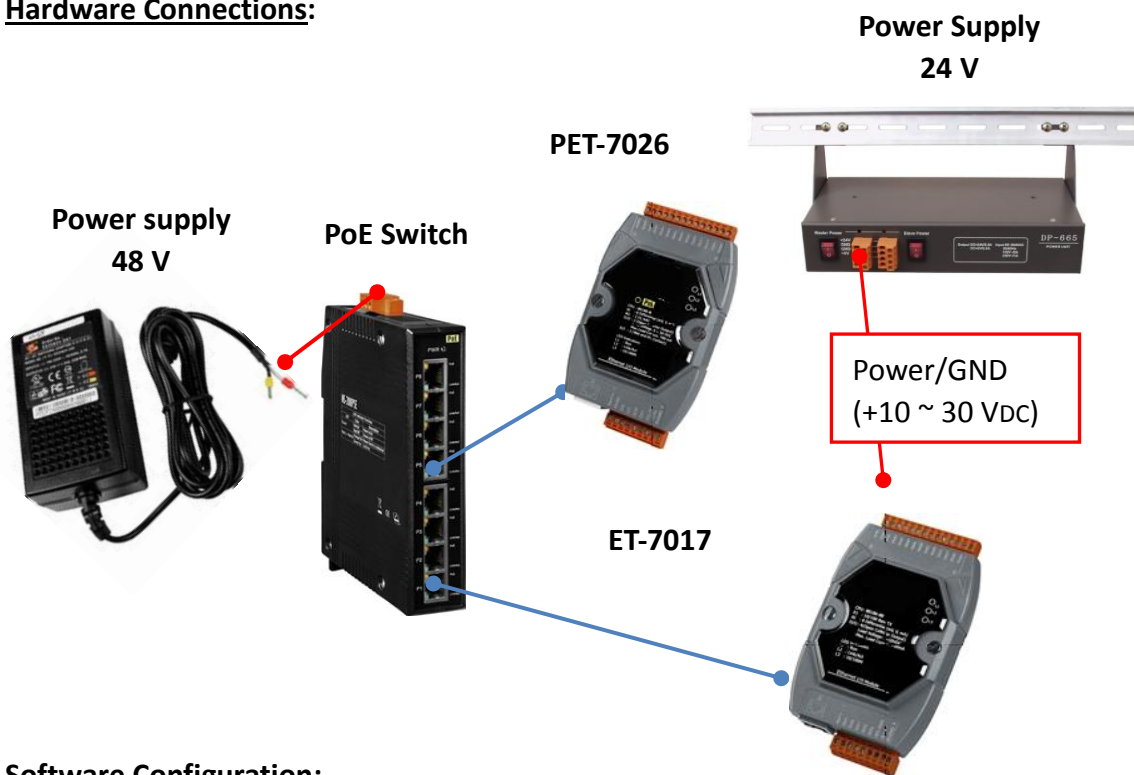

#### Software Configuration:

The following provides step-by-step instructions for how to configure the ET-7X00/PET-7X00 via the built-in web interface.

In this example, the AO0/AO1 of the PET-7026 must be mapped to the AI0/AI1 of the ET-7017. Later, when the AI0/AI1 of the ET-7017 receives the 5 V, the AO0/AO1 of the PET-7026 will automatically output 5 V.

### Step 1 : Log in to the PET-7026 web interface

Enter the IP address of the PET-7026 in the browser, and then enter your user name and password to log in to the PET-7026 web interface. Refer to chapter 3, “**Web Applications**”, for more details.

### Step 2 : Configure the AO type for the PET-7026

Click the “**Module I/O Settings**” option in the configuration section of the Main Menu to open the “**analog Output Settings**” page and set the voltage/current range to “**-5 V - 5V**”, and then click the “**Submit**” button. (Follow the same procedure to set the AI range for the ET-7017)

Channel	Range (40459)	Slow Rate (40523)
Ch0	35, -5 V ~ 5 V	0 (Immediate)
Ch1	35, -5 V ~ 5 V	0 (Immediate)

Submit

### Tips & Warnings



The settings for both the AO type for the PET-7026 and the AI type for the ET-7017 must be the same. In this example, they are both “**-5 V ~ 5 V**”.

### Step 3 : Configure the Modbus Settings for the PET-7026

Click the “**Pair Connection**” option in the “**Configuration**” section of the Main Menu and enter the details noted in the table below into the respective fields.

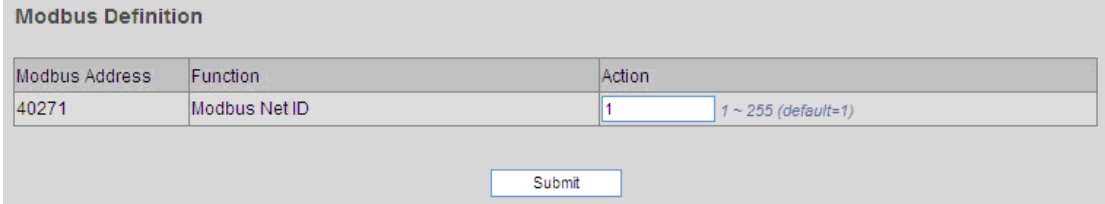
Field	Settings
I/O Pair Connection	Select this option to enable the I/O pair connection functions.
Remote IP Address	This is the IP address of the ET-7017 (e.g. 192.168.1.204)
Remote TCP Port	502
Connection Timeout	3000 ms
Reconnect Interval	5000 ms
Remote Net ID	1 (Default = 1, the Net ID for the ET-7017)
<p>To determine the Net ID, check the “Modbus Definition” section on the “Common Function” page, which can be found by clicking the “Module I/O Settings” option in the “Configuration” section of the Main Menu.</p> 	
Scan Time	300 ms
Access Type	Select AO
Local AO Base Address	0, (Starting from AO0 on the PET-7026)
Remote AI Base Address:	0, (Starting from AI0 on the ET-7017)
I/O Count	2, (Using AO0, AO1 and AI0, AI1)
Communication Timeout	400 ms

After completing the configuration, click the “**Submit**” button to save the settings.

**Modbus Settings**

Modbus Port	<input type="text" value="502"/>		
<b>1</b>			
<b><input checked="" type="checkbox"/> I/O Pair Connection</b>			
Remote IP Address	<input type="text" value="192.168.1.204"/>	Remote TCP Port	<input type="text" value="502"/>
Connection Timeout	<input type="text" value="3000"/> ms	Reconnect Interval	<input type="text" value="5000"/> ms
Remote NetID	<input type="text" value="1"/>	Scan Time	<input type="text" value="300"/> ms
Access Type	DO <input type="checkbox"/>		
Local DO Base Address	<input type="text" value="0"/>	Remote DI Base Address	<input type="text" value="0"/>
I/O Count	<input type="text" value="0"/>	Communication Timeout	<input type="text" value="0"/> ms
Access Type	AO <input checked="" type="checkbox"/>		
Local AO Base Address	<input type="text" value="0"/>	Remote AI Base Address	<input type="text" value="0"/>
I/O Count	<input type="text" value="2"/>	Communication Timeout	<input type="text" value="400"/> ms
<input type="button" value="Submit"/>			
<b>2</b>			

### Testing:

Before beginning testing, check that the Data Format settings are the same for both the PET-7026 and the ET-7017. To do this, click the “**Module I/O Settings**” option in the “**Configuration**” section of the main menu, and check the “**Basic Settings**” section on the “**Analog Input**” page.

**Analog Input Settings**  
Basic Settings

Channel	Range (40427)	Enabled (00595)
Ch0	08, -10 V ~ 10 V	OFF <input type="radio"/> ON <input checked="" type="radio"/>
Ch1	08, -10 V ~ 10 V	OFF <input type="radio"/> ON <input checked="" type="radio"/>
Ch2	08, -10 V ~ 10 V	OFF <input type="radio"/> ON <input checked="" type="radio"/>
Ch3	08, -10 V ~ 10 V	OFF <input type="radio"/> ON <input checked="" type="radio"/>
Ch4	08, -10 V ~ 10 V	OFF <input type="radio"/> ON <input checked="" type="radio"/>
Ch5	08, -10 V ~ 10 V	OFF <input type="radio"/> ON <input checked="" type="radio"/>

Modbus Address	Function	Action
00628	Normal mode (16 bits and 10 Hz), Fast mode (12 bits and 60 Hz) for AI	OFF <input checked="" type="radio"/> ON <input type="radio"/> 0=Normal, 1=Fast (default=0)
00629	60/50 Hz Rejection	OFF <input checked="" type="radio"/> ON <input type="radio"/> 0=60 Hz, 1=50 Hz (default=0)
00631	Data Format	OFF <input checked="" type="radio"/> ON <input type="radio"/> 0=Hex, 1=Engineering (default=0)
00632	Restore Analog Calibration to Factory Settings	<input type="checkbox"/>

Supply +5 V to AI0 on the ET-7017, and then click the “**Web HMI**” option in the “**Web HMI**” section of the Main Menu for the PET-7026, and then click the “**AO**” tab, where you will be able to check the AO0 value for the PET-7026.

AI AO DI DO Pair Page0-Carriage

**Analog Output**

No	Register	Hex Format	Floating Format	Value
AO0	40000	7FFF	5.000	<input type="text"/> -5V~5V <input type="button" value="Enter"/>
AO1	40001	0000	0.000	<input type="text"/> -5V~5V <input type="button" value="Enter"/>

Communication Status: Good

### 3.5.2. Example 2: Pair Connection - DO to DI

In this example, we will show how to use this feature to achieve DI/DO mapping on two remote I/O devices.

#### Hardware devices:

PET-7026 (AIO/DIO module), PET-7044 (DIO module), PoE Switch, and Power Supply (48 V).

#### Hardware Connections:

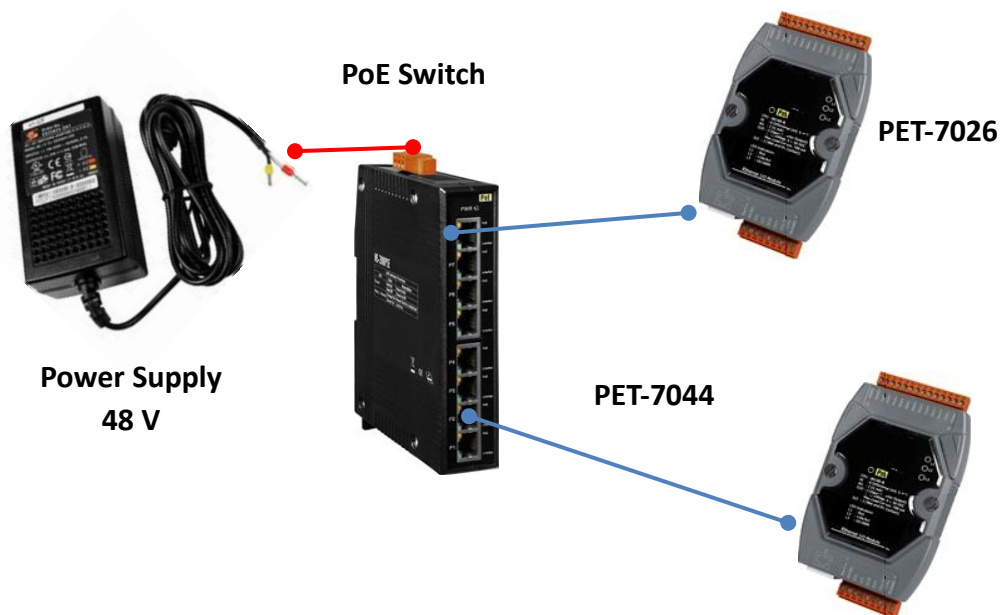

#### Software Configuration:

The following provides step-by-step instructions for how to configure the ET-7X00/PET-7X00 via the built-in web interface.

In this example, the DO0/DO1 of the PET-7026 must be mapped to the DI0/DI1 of the PET-7044. Later, when the status of the DI0/DI1 is switched to ON, the status of the DO0/DO1 will be switched to logic high automatically.



### Step 1 : Log in to the PET-7026 web interface

Enter the IP address of the PET-7026 in the browser, and then enter your user name and password to log in to the PET-7026 web interface. Refer to chapter 3 “**Web Applications**”, for more details.

### Step 2 : Configure the Modbus Settings for the PET-7026

Click the “Pair Connection” option in the Main Menu, and enter the details listed in the table below into the respective fields.

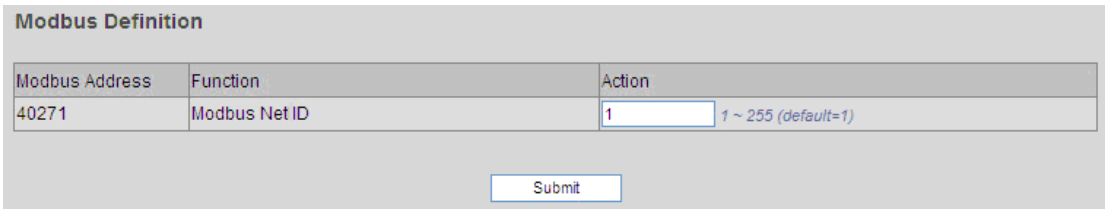
Field	Settings
I/O Pair Connection	Select this option to enable the I/O pair connection functions.
Remote IP Address	This is the IP address of the PET-7044 (e.g. 192.168.1.99)
Remote TCP Port	502
Connection Timeout	3000 ms
Reconnect Interval	5000 ms
Remote Net ID	1 (Default = 1, the Net ID for the PET-7044)
<p>To determine the Net ID, check the “<b>Modbus Definition</b>” section on the “<b>Common Function</b>” page, which can be found by clicking the “<b>Module I/O Settings</b>” option in the “<b>Configuration</b>” section of the Main Menu.</p> 	
Scan Time	300 ms
Access Type	Select DO
Local DO Base Address	0, (Starting from DO0 on the PET-7026)
Remote DI Base Address:	0, (Starting from DI0 on the PET-7044)
I/O Count	2, (Using DO0, DO1 and DI0, DI1)
Communication Timeout	400 ms

After completing the configuration, click the “**Submit**” button to save the settings.

**Modbus Settings**

Modbus Port: 502

**I/O Pair Connection**

Remote IP Address	192.168.1.204	Remote TCP Port	502
Connection Timeout	3000 ms	Reconnect Interval	5000 ms
Remote NetID	1	Scan Time	300 ms
Access Type	DO <input checked="" type="checkbox"/>		
Local DO Base Address	0	Remote DI Base Address	0
I/O Count	2	Communication Timeout	0 ms
Access Type	AO <input type="checkbox"/>		
Local AO Base Address	0	Remote AI Base Address	0
I/O Count	0	Communication Timeout	400 ms

Submit

**Testing:**

First, set the DIO status on the PET-7044 to ON, and then click the “**Web HMI**” option in the “**Web HMI**” section of the Main Menu for the PET-7026, and click the “**DO**” tab, you will notice the status of the DO0 has changed to “**ON**”.

AI AO DI DO Pair Page0-Carriage

**Digital Output**

No	Register	Status	Action
DO0	00000	<b>ON</b>	on off
DO1	00001	<b>OFF</b>	on off

Communication Status: Good

## 3.6. More Information

The “More Information” option in the main menu will open the ICP DAS site in your browser and display the main introduction page for the ET-7X00/PET-7X00 series of modules, which provides more detailed information related to the modules.

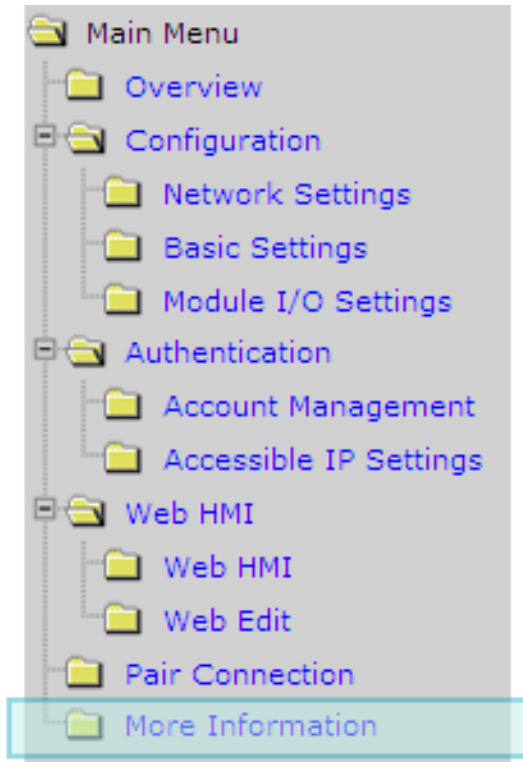

The URL for this link can be changed by simply editing the URL. For more details, refer to section 3.2.2 “Configure the web interface information”.

The default URL that the More Information item will link to:

[http://www.icpdas.com/root/product/solutions/remote\\_io/ethernet\\_io/et-7000\\_introduction.html](http://www.icpdas.com/root/product/solutions/remote_io/ethernet_io/et-7000_introduction.html)



ICP DAS  
http://www.icpdas.com

Contact us Site map Search

Certification Application Stories FAQ News & Events

Home About Company Products Download Distributors Partners Training Activity Catalog

**ET-7000/PET-7000**

> Introduction

> Selection Guide

**ET-7000/PET-7000** Web based I/O module 中文

**Introduction**

The ET-7000/PET-7000, a web-based Ethernet I/O module, features a built-in web server which allows configuration, I/O monitoring and I/O control by simply using a regular web browser. Remote control is as easy as surfing the Internet.

Besides, with the web HMI function, no more programming or HTML skills are required; creating dynamic and attractive web pages for I/O monitoring and I/O control would be fun to engineers ever after. The ET-7000/PET-7000 offers easy and safe access for users from anytime and anywhere! In addition, the ET-7000/PET-7000 also supports Modbus/TCP protocol that makes perfect integration to SCADA software.

Furthermore, PET-7000 features "PoE" that not only data but also power is carried through an Ethernet cable. This feature makes installation of PET-7000 a piece of cake. Imagine that no more unnecessary wires, only an Ethernet cable takes care of everything in the field.

## 4. Modbus and Modbus TCP/IP

Modbus is a serial communication protocol that allows a wide variety of instruments to be connected to a common data collection network.

Modbus/TCP is a variant of the Modbus communication protocol that allows devices to communicate over a TCP/IP.

With the support of the Modbus TCP protocol, the ET-7X00/PET-7X00 series module can communicate with PC-based applications, such as SCADA (Supervisor Control And Data Acquisition) and HMI programs. The Modbus/TCP information is only available via an Ethernet interface.

The Modbus/TCP messaging service provides a Client/Server communication between devices connected on a TCP/IP network. The ET-7X00/PET-7X00 module is a Modbus Server, meaning that it is only capable of responding to requests from the Modbus client device. Note that the Modbus/RTU protocol requires a serial interface, not Ethernet, and is therefore not directly compatible with the ET-7X00/PET-7X00 module.

The Modbus protocol, as well as the TCP extension, is well documented in the specifications, which are available at <http://www.modbus.org>, a website established by the Modbus Organization to provide support and organization for the Modbus protocol. Only the use of the protocol is documented here.

## 4.1. Modbus TCP/IP Interface

The Modbus/TCP interface is attached to the TCP/IP stack that is implemented within the ET-7X00/PET-7X00 module, and will listen to all communications that come in on Modbus/TCP registered Port 502.

The Modbus/TCP client uses the standard TCP method for communicating with the ET-7X00/PET-7X00 module. UP to 12 connections are possible at one time. If there are 12 active connections, any attempt at any more connections is ignored.

## 4.2. Protocol Description

The Modbus protocol defines a simple protocol data unit independent of the underlying communication layers. The mapping of Modbus protocol on network can introduce some additional fields on the application data unit.

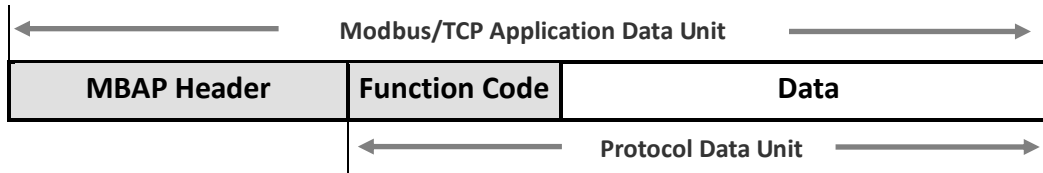

### MBAP

The Modbus/TCP extension includes 7 additional bytes to the original Modbus protocol, which allows for transport over the TCP/IP layers.

A dedicated header is used on TCP/IP to identify the Modbus Application Data Unit. It is called the MBAP Header (MODBUS Application Protocol Header). The MBAP Header consists of 7 bytes of information:

Field	Length	Description
Transaction Identifier	2 bytes	Identification of Request/Response transaction – Copied from request to response
Protocol Identifier	2 bytes	0 = Modbus protocol
Length	2 bytes	Number of following bytes - Includes the Unit Identifier
Unit Identifier	1 byte	Identification of remote slave

## Function Code

The function code field of a Modbus data unit is coded in one byte. Valid codes are in the range of 1 ... 255 decimal (the range 128 - 255 is reserved and used for exception responses). When a Modbus request is sent from a Modbus Client to a Server device the function code field tells the Server what kind of action to perform.

The Modbus/TCP feature of ET-7X00/PET-7X00 series module supports 8 function codes, which allows the reading and writing of data contents of registers.

Function Code	Function
01 (0x01)	Read Coil Status
02 (0x02)	Read Input Status
03 (0x03)	Read Holding Registers
04 (0x04)	Read Input Registers
05 (0x05)	Force Single Coil
06 (0x06)	Preset Single Register
15 (0x0F)	Force Multiple Coils
16 (0x10)	Preset Multiple Registers

Any other function code request will be returned with an error response indicating the function code is not supported, as well as a request for too much data or data at a register address that not present.

## Data

The data field of Modbus request sent from a client to server devices contains additional information that the server uses to take the action defined by the function code. This can include items like discrete and register addresses, the quantity of items to be handled, and the count of actual data bytes in the field.

The data field may be nonexistent (of zero length) in certain kinds of requests; in this case the server does not require any additional information. The function code alone specifies the action.



## Response

If no error occurs related to the Modbus function requested in a properly received Modbus PDU (Protocol Data Unit) the data field of a Modbus response from a server to a client contains the data requested. If an error related to the Modbus function requested occurs, the field contains an exception code that the server application can use to determine the next action to be taken.

For example a client can read the ON/OFF states of a group of digital input or output or it can read/write the data contents of a group of registers.

When the server responds to the client, it uses the function code field to indicate either a normal response or that some kind of error occurred (called an exception response). For a normal response, the server simply echoes to the request the original function code.

For an exception response, the server returns a code that is equivalent to the original function code from the request PDU with its most significant bit set to logic 1.

## 4.3. Data Encoding

Modbus uses a “big-endian” representation for address and data items. This means that when a numerical quantity larger than single byte is transmitted, the most significant byte (MSB, also called the high-order byte) is send first. The following sub-topics describe the different byte of encoding and show how the data is encoded as it is within the Modbus/TCP packet.

### 4.3.1. Binary

A binary item is represented as a single bit within a data word. All binary is packed into 16-bits data words, which are accessed using function code 01 and 02. Therefore, a single register contains 16 bits of binary data, each having a specific meaning.

Value	1st	2nd
0xAA55 (1010101001010101)	0xAA (10101010)	0x55 (01010101)

### 4.3.2. 16-bits Word

A 16-bits word item is transmitted with the most significant byte first. Function code 03 and 04 read 16-bits items at a time; therefore, each of these data items will fit within one register that is read.

Value	1st	2nd
0x1234	0x12	0x34

## 4.4. Data Model

Modbus bases its data model on a series of tables that have individual characteristics. The four primary tables are:

Primary table	Data type	Type of access
Discrete Input	Single bit	Read-Only
Coils	Single bit	Read-Write
Input Registers	16-bits word	Read-Only
Holding Registers	16-bits word	Read-Write

To access each entry in to the four primary tables, a starting address (0 indicates the first entry in the table) is required as well as the number of registers that are requested.

For each of the primary tables, the protocol allows individual selection of 65535 data items, and the operations of read or write of those items are designed to span multiple consecutive data items up to a data size limit which is dependent on the transaction function code.

Once the data is stored within the local tables, the driver does not differentiate what is stored in them. The Modbus/TCP client needs to know what data is stored in which register locations to be able to retrieve it, process it, and/or display it.

## 4.5. Modbus Functions and Registers

### 4.5.1. 01 (0x01) Read Coils

This function code is used to read the status of coils in an ET-7X00/PET-7X00 module. The Request PDU specifies the starting address, i.e. the address of the first coil specified, and the number of coils. In the PDU Coils are addressed starting at zero.

The coils in the response message are packed as one coil per bit of the data field. Status is indicated as 1=ON and 0=OFF. The LSB of the first data byte contains the output addressed in the query. The other coils follow toward the high order end of this byte, and from low order to high order in subsequent bytes.

If the returned output quantity is not a multiple of eight, the remaining bits in the final data byte will be padded with zeros (toward the high order end of the byte). The Byte Count field specifies the quantity of complete bytes of data.

Here is an example of a request to read digital outputs of ET-7026/PET-7026 module:

Request		Response	
Field Name	(Hex)	Field Name	(Hex)
MBAP Header	01	MBAP Header	01
	02		02
	00		00
	00		00
	00		00
	06		04
Unit Identifier	01	Unit Identifier	01
Function Code	01	Function Code	01
Starting Address Hi	00	Byte Count	01
Starting Address Lo	00	Outputs status 0-1	02
Quantity of Outputs Hi	00		
Quantity of Outputs Lo	02		

The status of outputs 0-1 is shown as the byte value 02 hex, or binary 0000 0010. DO1 is in the seventh bit position from the left, and DO0 is the LSB of this byte. The six remaining high order bits are zero filled.

## 4.5.2. 02 (0x02) Read Discrete Inputs

This function code is used to read status of discrete inputs in an ET-7X00/PET-7X00 module. The Request PDU specifies the starting address, i.e. the address of the first input specified, and the number of inputs. In the PDU Discrete inputs are addressed starting at zero.

The discrete inputs in the response message are packed as one input per bit of the data field. Status is indicated as 1=ON and 0=OFF. The LSB of the first data byte contains the input addressed in the query. The other inputs follow toward the high order end of this byte, and from low order to high order in subsequent bytes.

If the returned input quantity is not a multiple of eight, the remaining bits in the final data byte will be padded with zeros (toward the high order end of the byte). The Byte Count field specifies the quantity of complete bytes of data.

Here is an example of a request to read digital inputs of ET-7026/PET-7026 module:

Request		Response	
Field Name	(Hex)	Field Name	(Hex)
MBAP Header	01	MBAP Header	01
	02		02
	00		00
	00		00
	00		00
	06		04
Unit Identifier	01	Unit Identifier	01
Function Code	02	Function Code	02
Starting Address Hi	00	Byte Count	01
Starting Address Lo	00	Digital Inputs status 0-1	03
Quantity of Inputs Hi	00		
Quantity of Inputs Lo	02		

The status of Inputs 0-1 is shown as the byte value 03 hex, or binary 0000 00**11**. D11 is in the seventh bit position from the left, and D10 is the LSB of this byte. The six remaining high order bits are zero filled.

### 4.5.3. 03 (0x03) Read Holding Registers

This function code is used to read the contents of a contiguous block of holding registers in an ET-7X00/PET-7X00 module. The Request PDU specifies the starting register address and the number of registers. In the PDU Registers are addressed starting at zero.

The register data in the response message are packed as two bytes per register, with the binary contents right justified within each byte. For each register, the first byte contains the high order bits and the second contains the low order bits.

Here is an example of a request to read analog outputs of ET-7026/PET-7026 module:

Request		Response	
Field Name	(Hex)	Field Name	(Hex)
MBAP Header	01	MBAP Header	01
	02		02
	00		00
	00		00
	00		00
	06		07
Unit Identifier	01	Unit Identifier	01
Function Code	03	Function Code	03
Starting Address Hi	00	Byte Count	04
Starting Address Lo	00	Register value Hi (AO0)	02
Quantity of Outputs Hi	00	Register value Lo (AO0)	2B
Quantity of Outputs Lo	02	Register value Hi (AO1)	00
		Register value Lo (AO1)	64

The contents of AO0 are shown as the two byte values of 02 2B hex, or 555 decimal. The content of AO1 are 00 64, or 100 decimal.

#### 4.5.4. 04 (0x04) Read Inputs Registers

This function code is used to read input registers in an ET-7X00/PET-7X00 module. The Request PDU specifies the starting register address and the number of registers. In the PDU Registers are addressed starting at zero.

The register data in the response message are packed as two bytes per register, with the binary contents right justified within each byte. For each register, the first byte contains the high order bits and the second contains the low order bits.

Here is an example of a request to read analog inputs of ET-7026/PET-7026 module:

Request		Response	
Field Name	(Hex)	Field Name	(Hex)
MBAP Header	01	MBAP Header	01
	02		02
	00		00
	00		00
	00		00
	06		07
Unit Identifier	01	Unit Identifier	01
Function Code	04	Function Code	04
Starting Address Hi	00	Byte Count	04
Starting Address Lo	00	Register value Hi (AI0)	00
Quantity of Inputs Hi	00	Register value Lo (AI0)	0A
Quantity of Inputs Lo	02	Register value Hi (AI1)	00
		Register value Lo (AI1)	64

The contents of AI0 are shown as the two byte values of 00 0A hex, or 10 decimal. The content of AI1 are 00 64, or 100 decimal.

### 4.5.5. 05 (0x05) Write Single Coil

This function code is used to write a single digital output to either ON or OFF in an ET-7X00/PET-7X00 module. The requested ON/OFF state is specified by a constant in the request data field. A value of FF 00 hex requests the output to be ON. A value of 00 00 requests it to be OFF. All other values are illegal and will not affect the output.

The normal response is an echo of the request, returned after the coil state has been written.

Here is an example of a request to write DO1 of ET-7026/PET-7026 ON:

Request		Response	
Field Name	(Hex)	Field Name	(Hex)
MBAP Header	01	MBAP Header	01
	02		02
	00		00
	00		00
	00		00
	06		06
Unit Identifier	01	Unit Identifier	01
Function Code	05	Function Code	05
Output Address Hi	00	Output Address Hi	00
Output Address Lo	01	Output Address Lo	01
Output Value Hi	FF	Output Value Hi	FF
Output Value Lo	00	Output Value Lo	00



#### 4.5.6. 06 (0x06) Write Single Register

This function code is used to write a single analog output in an ET-7X00/PET-7X00 module. The Request PDU specifies the address of the register to be written. Registers are addressed starting at zero.

The normal response is an echo of the request, returned after register contents have been written.

Here is an example of a request to write AO1 of ET-7026/PET-7026 to 55 FF hex:

Request		Response	
Field Name	(Hex)	Field Name	(Hex)
MBAP Header	01	MBAP Header	01
	02		02
	00		00
	00		00
	00		00
	06		06
Unit Identifier	01	Unit Identifier	01
Function Code	06	Function Code	06
Register Address Hi	00	Register Address Hi	00
Register Address Lo	01	Register Address Lo	01
Register Value Hi	55	Register Value Hi	55
Register Value Lo	FF	Register Value Lo	FF

### 4.5.7. 15 (0x0F) Write Multiple Coils

This function code is used to force each coil in a sequence of coils to either ON or OFF in an ET-7X00/PET-7X00 module. The Request PDU specifies the coil references to be forced. Coils are addressed starting at zero.

The requested ON/OFF states are specified by contents of the request data field. A logical '1' in a bit position of the field requests the corresponding output to be ON. A logical '0' requests it to be OFF.

The normal response returns the function code, starting address, and quantity of coils forced.

Here is an example of a request to write a series of 2 digital outputs starting at DO0:

The request data content is one byte: 02 hex (0000 0010 binary). The binary bits correspond to the outputs in the following way:

Bit	0	0	0	0	0	0	1	0
Output	-	-	-	-	-	-	DO1	DO0

Request		Response	
Field Name	(Hex)	Field Name	(Hex)
MBAP Header	01	MBAP Header	01
	02		02
	00		00
	00		00
	00		00
	06		06
Unit Identifier	01	Unit Identifier	01
Function Code	0F	Function Code	0F
Starting Address Hi	00	Starting Address Hi	00
Starting Address Lo	00	Starting Address Lo	00
Quantity of Outputs Hi	00	Quantity Value Hi	00
Quantity of Outputs Lo	02	Quantity Value Lo	02
Byte Count	01		
Outputs Value Lo	02		

## 4.5.8. 16 (0x10) Write Multiple Registers

This function code is used to write a block of contiguous registers in an ET-7X00/PET-7X00 module. The requested written values are specified in the request data field. Data is packed as two bytes per register.

The normal response returns the function code, starting address, and quantity of registers written.

Here is an example of a request to write two AO registers starting at A00:

Request		Response	
Field Name	(Hex)	Field Name	(Hex)
MBAP Header	01	MBAP Header	01
	02		02
	00		00
	00		00
	00		00
	06		06
Unit Identifier	01	Unit Identifier	01
Function Code	10	Function Code	10
Starting Address Hi	00	Starting Address Hi	00
Starting Address Lo	00	Starting Address Lo	00
Quantity of Registers Hi	00	Quantity Value Hi	00
Quantity of Registers Lo	02	Quantity Value Lo	02
Byte Count	04		
Registers Value Hi	00		
Registers Value Lo	0A		
Registers Value Hi	01		
Registers Value Lo	02		

## 4.6. Modbus Master Simulators

In the previous section, we introduced the Modbus communication protocol. Now, we will describe how to achieve the Modbus/TCP communication between the ET-7X00/PET-7X00 module and PC-connection.

### 4.6.1. Modbus/TCP Client

Modbus/TCP Client is a Modbus master simulator and test utility designed primarily to help users who want to test and simulate the Modbus protocol. Using the Modbus/TCP Client application, you can compose and send individual Modbus requests to a Modbus slave, and it can also continually poll (send read and write requests to) the slave. Subsequently, you can re-run the sequence of commands.

For each individual Modbus request you specify the slave ID, function code, starting address and quantity. You can refer to the previous section for more detailed information about Modbus communication protocol.

The complete version of the Modbus/TCP Client can be obtained from the companion CD:

CD:\NAPDOS\Software\Modbus\_TCP\_Client\

or from the ICP DAS FTP site at:

[ftp://ftp.icpdas.com/pub/cd/6000cd/napdos/software/modbus\\_tcp\\_client/](ftp://ftp.icpdas.com/pub/cd/6000cd/napdos/software/modbus_tcp_client/)

The following instructions will help you to read the status of digital inputs in an ET-7026 by using the Modbus/TCP Client application.

**Step 1: Double-click the “MBTCP.exe” to open it.**



**Step 2: Type in the IP address of ET-7026 that you wish to communication with in the Modbus TCP block shown below. Then click the “Connect” button to connect the module.**

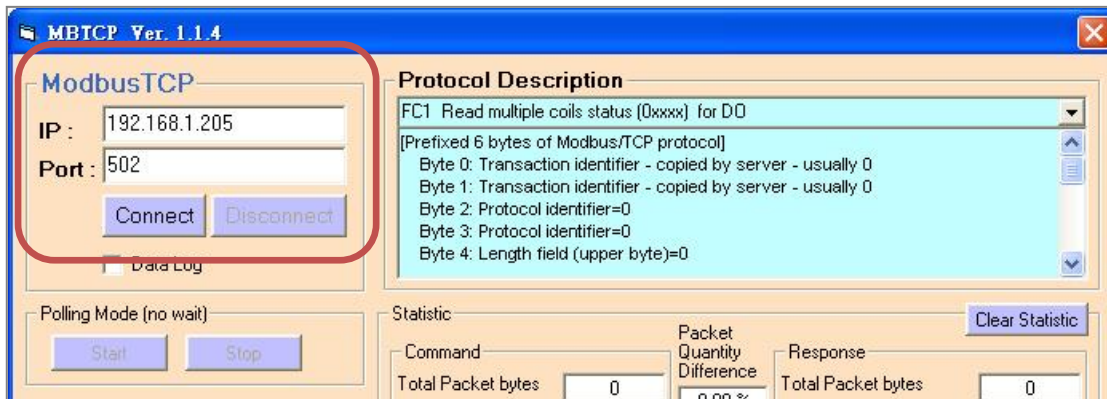

**Step 3: Send a Modbus query to the ET-7026 by clicking the “Send” button. An example of a query to read digital inputs 0 to 1 from the ET-7026 at Modbus ID 1 is given below.**

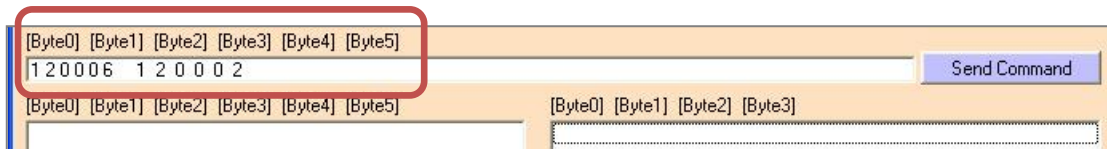

**Step 4: If no error occurs, a data field of a response from the ET-7026 to the Modbus/TCP Client contains the status of digital inputs of ET-7026.**

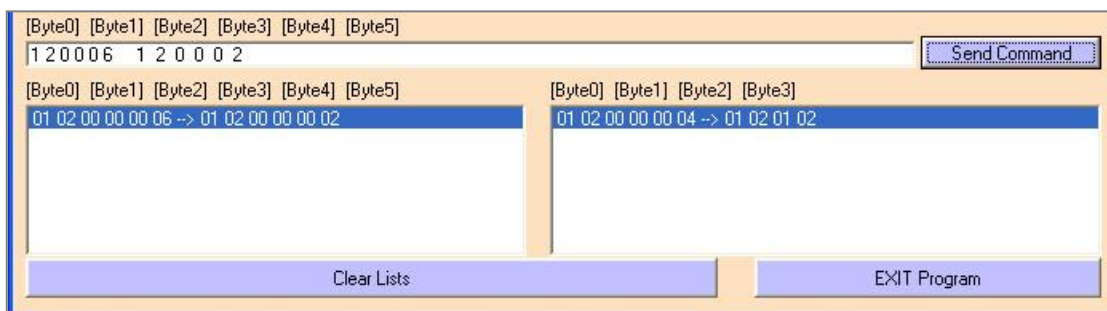

For a more detailed description of this function code, see the “Protocol Description” group box.

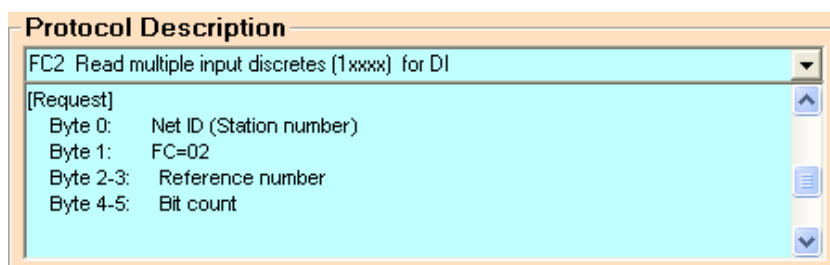

## 4.6.2. Modbus Master Tool

Modbus Master Tool is a Modbus master simulator designed by ICP DAS. It used to help developers of Modbus slave devices or others that want to test the Modbus connection.

The complete version of the Modbus Master Tool can be obtained from the companion CD:

CD:\NAPDOS\Software\Modbus\_Master\_Tool\

or from the ICP DAS FTP site at:

[ftp://ftp.icpdas.com/pub/cd/6000cd/napdos/software/modbus\\_master\\_tool/](ftp://ftp.icpdas.com/pub/cd/6000cd/napdos/software/modbus_master_tool/)

The following are the step-by-step instruction on how to read the DO status of PET-7026.

**Step 1: Double-click the “ModbusMasterToolPC.exe” to open it.**



**Step 2: Click the “Setup > Definition” in menu bar to setup the parameters.**

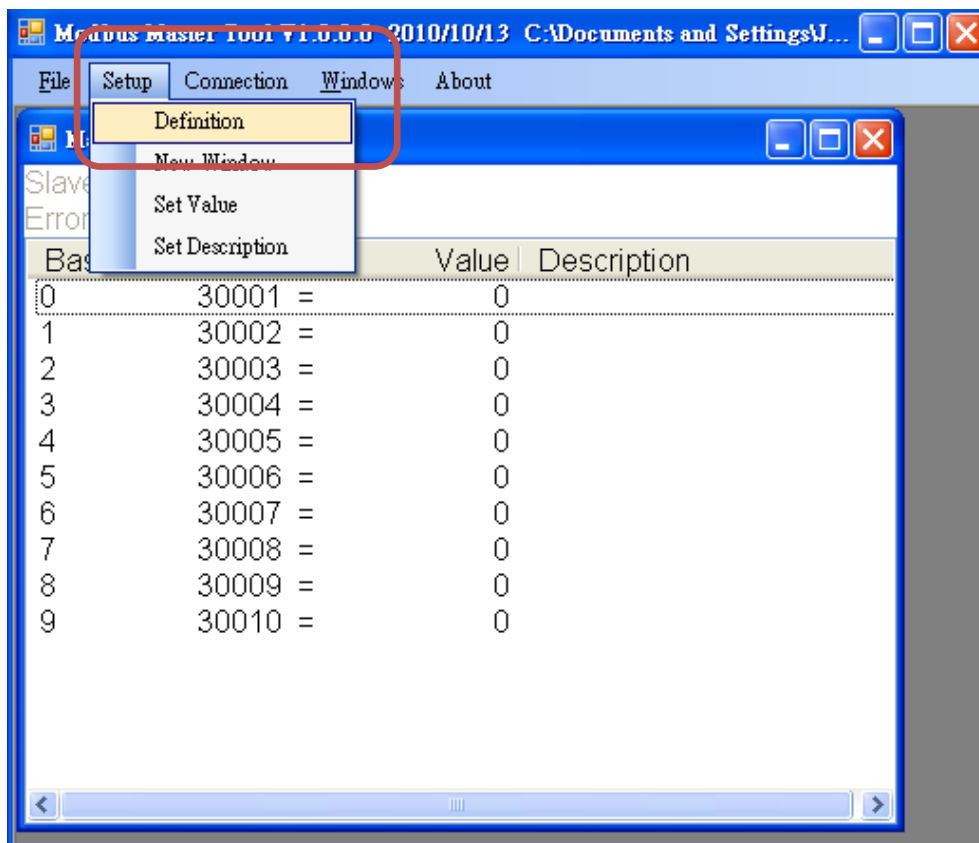

We use the same example in the [section 4.5.1](#); you can see the parameters in the table.

Request		
	Field Name	(Hex)
1	Unit Identifier	01
2	Function Code	01
3	Starting Address Hi	00
	Starting Address Lo	00
4	Quantity of Outputs Hi	00
	Quantity of Outputs Lo	02

You can go to "Modules I/O Settings" (section 3.2.3) to check/set the ID.

01 (0x01) Read Coils

Starting from D00

Read two channels

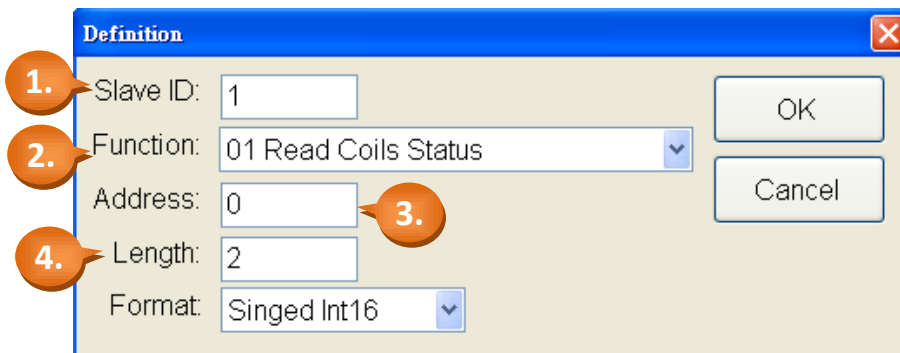

### Tips & Warnings



Please select "Hex" options in the "Format" drop-up menu when you read/write the AO/AI.

**Step 3:** Click the "Connection > Connect" to set TCP Connection.

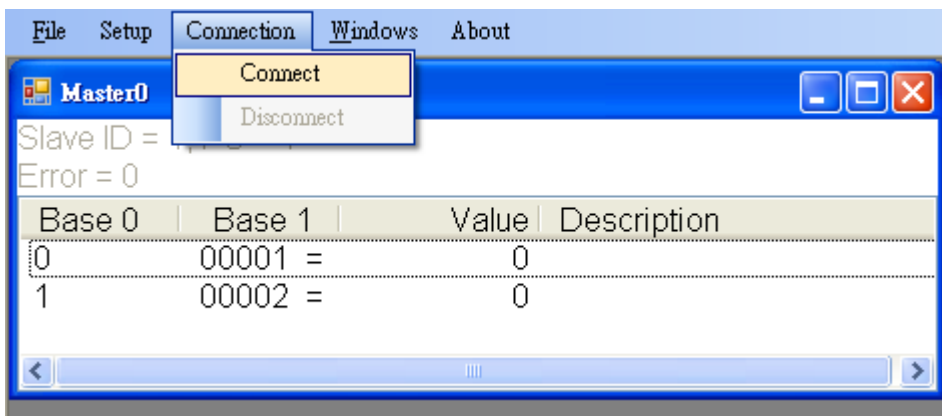

1. Select "TCP/IP" in the "Interface" field.
2. Fill out the PET-7026's IP address in the "Remote Server IP".
3. You can keep the settings of other fields or change them then click OK.

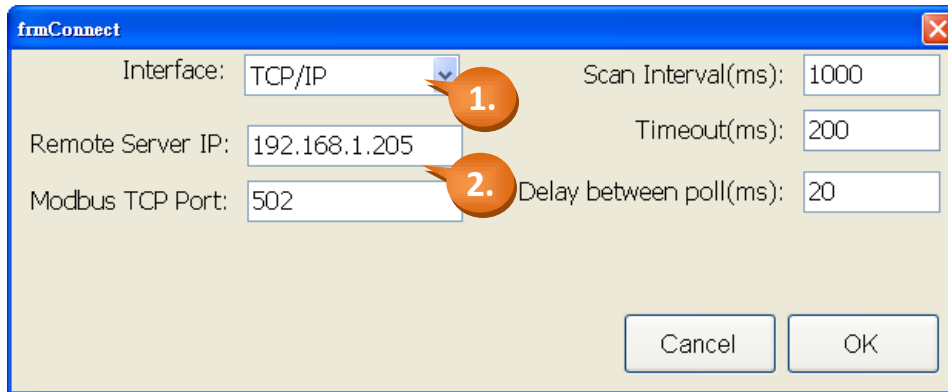

Now, the DO status of PET-7026 will show on the screen. (1: ON; 0: OFF)

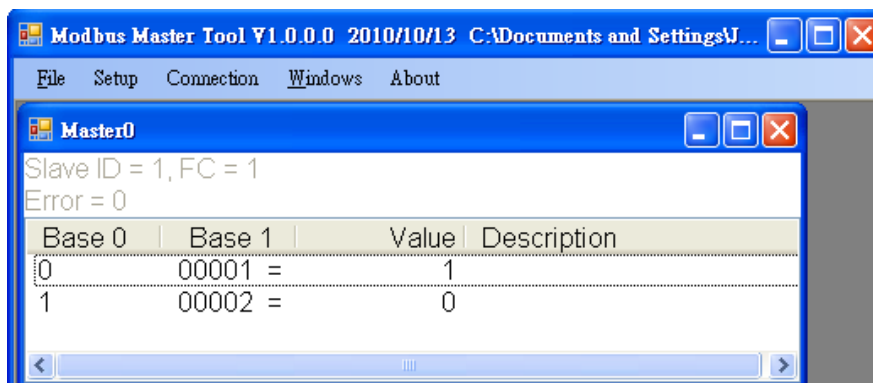



## 4.7. Modbus Demo Programs

nModbus is a C# 3.0 implementation of the Modbus protocol. It is developed and maintained on a voluntary basis and provided free of charge.

The DLL based on the official releases from <http://nmodbus.googlecode.com> was verified and improved. Programmer can use the DLL released to develop a Modbus application for regular Windows based PCs.

The relevant Modbus demo and SDK can be obtained from the following ICP DAS website.

- DLL and Documents:

<ftp://ftp.icpdas.com/pub/cd/8000cd/napdos/modbus/nmodbus/>

- Demo:

<ftp://ftp.icpdas.com/pub/cd/8000cd/napdos/modbus/nmodbus/demo/>

# 5. Calibration

## Tips & Warnings

---



It is not recommended that calibration be performed until the process is fully understood.

---

## 5.1. Voltage and Current Calibration

### Analog Input Calibration Requirement for ET-7X00/PET-7X00

Connect the calibration voltage/current source to channel 0 and only the channel 0 should be enabled during calibration.

### Type Code

The following table shows all of the type code for use in voltage and current, you can use it upon the model number of ET-7X00/PET-7X00 (e.g. ET-7017 can use type 07 ~ 1A).

Type Code	00	01	02	03	04	05	06	07
Zero Input	0 mV	0 mV	0 mV	0 mV	0 V	0 V	0 mA	0mA
Span Input	+15 mV	+50 mV	+100 mV	+500 mV	+1 V	+2.5 V	+20 mA	+20 mA

Type Code	08	09	0A	0B	0C	0D	1A
Zero Input	0 V	0 V	0 V	0 mV	0 mV	0 mA	0 mA
Span Input	+10V	+5 V	+1 V	+500 mV	+150 mV	+20 mA	+20 mA

The following steps will show you how to calibrate the ET-7017 (8 AI, 4 DO):

**Step 1 : Warm up the module for 30 minutes.**

**Step 2 : Enable the channel 0 to calibrate and disable other channels.**

Please go to the configuration page of Modules I/O Settings (refer to Section 0), set AI0 as ON and the others as OFF. (As figure below)

**Step 3 : Set the type code to the type you want to calibrate.**

Select the AI range (e.g. 09, -5V ~ 5V) then click “Submit” button.

**Analog Input**  
Basic Setting

	Range (40427)	Enable (00595)
Ch0	09, -5V~5V	OFF <input type="radio"/> ON <input checked="" type="radio"/>
Ch1	08, -10V~10V	OFF <input checked="" type="radio"/> ON <input type="radio"/>
Ch2	08, -10V~10V	OFF <input checked="" type="radio"/> ON <input type="radio"/>
Ch3	08, -10V~10V	OFF <input checked="" type="radio"/> ON <input type="radio"/>
Ch4	08, -10V~10V	OFF <input checked="" type="radio"/> ON <input type="radio"/>
Ch5	08, -10V~10V	OFF <input checked="" type="radio"/> ON <input type="radio"/>
Ch6	08, -10V~10V	OFF <input checked="" type="radio"/> ON <input type="radio"/>
Ch7	08, -10V~10V	OFF <input checked="" type="radio"/> ON <input type="radio"/>

**Step 4 : Enable calibration.**

We will use the software – Modbus Master Tool - to complete the step 4 ~ 8.

The complete version of the Modbus Master Tool can be obtained from the companion CD:

CD:\NAPDOS\Software\Modbus\_Master\_Tool\

or from the ICP DAS FTP site at:

[ftp://ftp.icpdas.com/pub/cd/6000cd/napdos/software/modbus\\_master\\_tool/](ftp://ftp.icpdas.com/pub/cd/6000cd/napdos/software/modbus_master_tool/)

4.1 Please double-click the “ModbusMasterToolPC.exe” to open it and click the “Setup > Definition” in menu bar to setup the parameters.

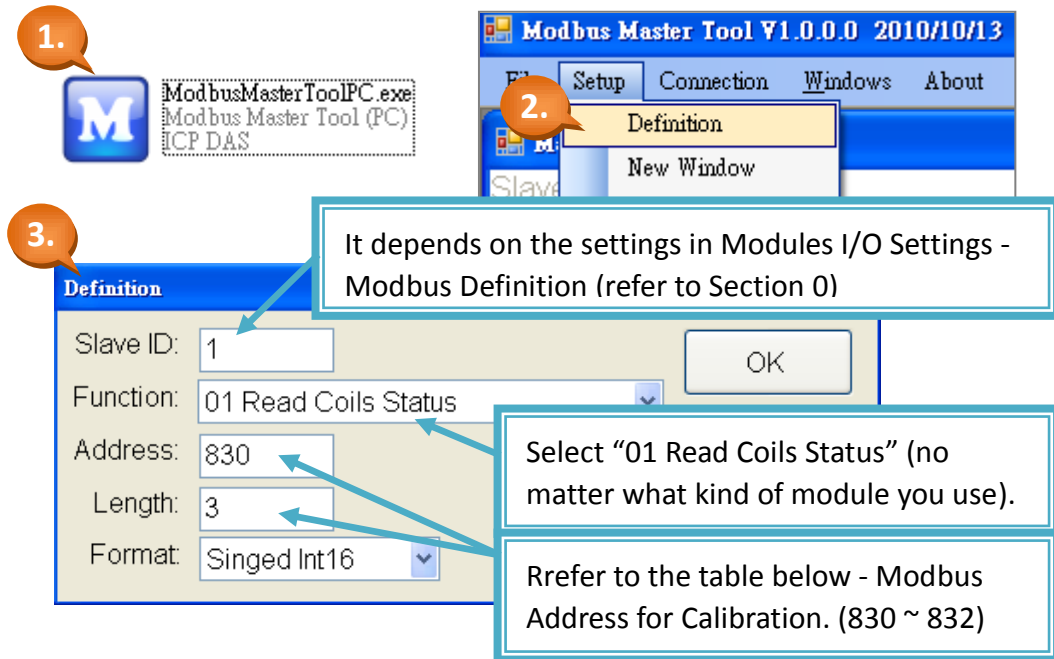

### Modbus Address for Calibration

Register	Points	Description	Access Type
00830	1	Enable/Disable Calibration 0=Disabled 1=Enabled	R/W
00831	1	Zero calibration command of ch0, 1 = run	W (Pulse)
00832	1	Span calibration command of ch0, 1 = run	W (Pulse)

**Note:** When calibrating current type (i.e. type 06, 07 and 1A), the jumper of the corresponding channel should be short.

Refer to the link for details.

[ftp://ftp.icpdas.com/pub/cd/6000cd/napdos/et7000\\_et7200/document/data\\_sheet/](ftp://ftp.icpdas.com/pub/cd/6000cd/napdos/et7000_et7200/document/data_sheet/)

4.2 Clicking the “Connection > Connect” in menu bar and fill out the ET-7017’s IP address to set TCP Connection.

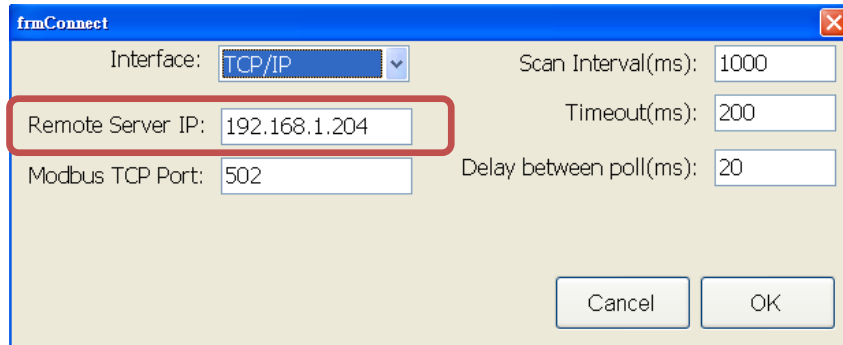

4.3 Double-click on address 830 to set it as “ON”. (Enable Calibration)

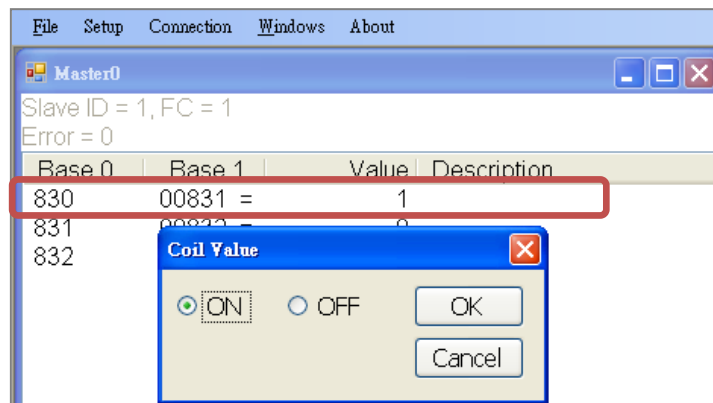

**Step 5 : Apply the zero calibration voltage/current to channel 0.**

In this example, we use type code - 09 and its “Zero Input” is 0 V.

Type Code	09
Input Range	-5V ~ +5 V

### Step 6 : Send the zero calibration command.

Double-click on address 831 to set it as ON. If the calibration is successful, the value will return 0.

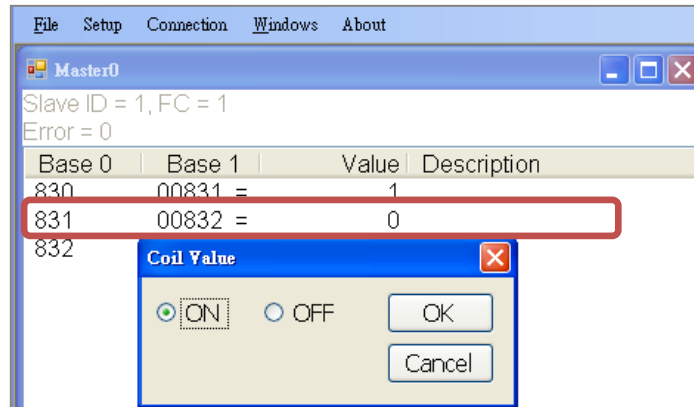

### Step 7 : Apply the span calibration voltage/current to channel 0.

In this example, we use type code - 09 and its "Span Input" is +5 V.

Type Code	09
Input Range	-5V ~ +5 V

### Step 8 : Send the span calibration command.

Double-click on address 832 to set it as ON. If the calibration is successful, the value will return 0.

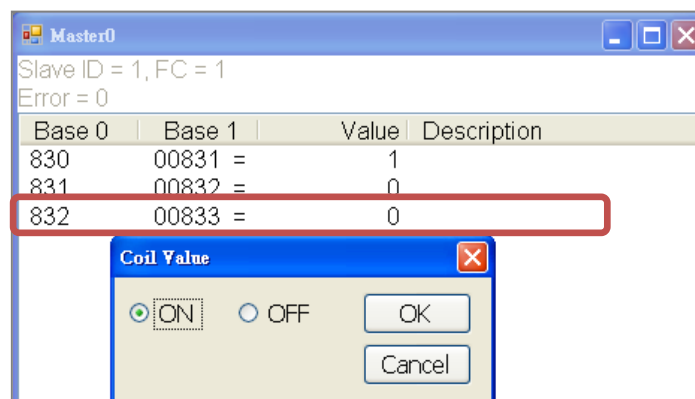

### Step 9 : Disable calibration.

As figure above, double-click on address 830 to set it as OFF.

## 5.2. Thermocouple Calibration

### Type Code

The following table shows all of the type code for use in thermocouple.

Type Code	14	18	0E	10	12	13	15	16	19	0F	11	17
Thermocouple Calibration Range	00		01						02			
Zero Input	0 mV		0 mV						0 mV			
Span Input	+15 mV		+50 mV						+100 mV			

The calibration procedure is similar to the section 5.1. But, the difference between them is that the ET-7X00/PET-7X00 doesn't directly support type code - 0E ~ 19 for AI calibration, so you need to change the channel 0 as range - 00 ~ 02 to complete the work (refer to section 5.1 step 3).

- Step 1** Warm up the module for latest 30 minutes.
- Step 2** Set the type code to the type you wish to calibrate.
- Step 3** Enable calibration.
- Step 4** Apply the zero calibration voltage to channel 0.
- Step 5** Send the zero calibration command.
- Step 6** Apply the span calibration voltage to channel 0.
- Step 7** Send the span calibration command.
- Step 8** Disable calibration.

### For example

If you want to calibrate type 0E, you need to set the channel 0 as range - 01.

**Modbus Settings (AI Basic Setting)**

	Range (40427)	Enable (00595)
Ch0	[01] +/-50mV	OFF <input type="radio"/> ON <input checked="" type="radio"/>
Ch1	[05] +/-2.5V	OFF <input checked="" type="radio"/> ON <input type="radio"/>
Ch2	[05] +/-2.5V	OFF <input checked="" type="radio"/> ON <input type="radio"/>

## 5.3. RTD Calibration

### Type Code

The following table shows all of the type code for use in RTD calibration.

Type Code	20 ~ 29	2E	2F	80	81	83	2B	2C	82	2A	2D
Zero Calibration Resistor	0 $\Omega$						0 $\Omega$			0 $\Omega$	
Span Calibration Resistor	375 $\Omega$						200 $\Omega$			3200 $\Omega$	

### Modbus Address for Calibration

Register	Points	Description	Access Type
00830	1	Enable/Disable Calibration 0=Disabled 1=Enabled	R/W
00831	1	Zero calibration command of ch0, 1=run	W (Pulse)
00832	1	Span calibration command of ch0, 1=run	W (Pulse)
00833	1	Zero calibration command of ch1, 1=run	W (Pulse)
00834	1	Span calibration command of ch1, 1=run	W (Pulse)
00835	1	Zero calibration command of ch2, 1=run	W (Pulse)
00836	1	Span calibration command of ch3, 1=run	W (Pulse)
00837	1	Zero calibration command of ch3, 1=run	W (Pulse)
00838	1	Span calibration command of ch3, 1=run	W (Pulse)
00839	1	Zero calibration command of ch4, 1=run	W (Pulse)
00840	1	Span calibration command of ch4, 1=run	W (Pulse)
00841	1	Zero calibration command of ch5, 1=run	W (Pulse)
00842	1	Span calibration command of ch5, 1=run	W (Pulse)

The calibration procedure is similar to the section 5.1. However, the RTD calibration required an external resistor and must be calibrate for each channel rather than just the ch0 we mentioned before.



The calibration procedure is as follows:

- Step 1 Warm up the module for latest 30 minutes.**
- Step 2 Set the type code to the type you wish to calibrate.**
- Step 3 Enable calibration.**
- Step 4 Connect the zero calibration resistor.**  
(Refer to the table – Type Code)
- Step 5 Send the zero calibration command.**  
(Refer to the table - Modbus Address for Calibration)
- Step 6 Connect the span calibration resistor.**  
(Refer to the table – Type Code)
- Step 7 Send the span calibration command.**  
(Refer to the table - Modbus Address for Calibration)
- Step 8 Disable calibration.**

## 5.4. Recover Calibration to Factory Setting

Please go to the configuration page of Modules I/O Settings – Analog Input (refer to Section 0). After you selecting the "Recover AI Calibration to Factory Setting", it will auto complete the function.

**Analog Input**  
Basic Setting

	Range (40427)	Enable (00595)
Ch0	08, -10V~10V	OFF <input type="radio"/> ON <input checked="" type="radio"/>
Ch1	08, -10V~10V	OFF <input type="radio"/> ON <input checked="" type="radio"/>
Ch2	08, -10V~10V	OFF <input type="radio"/> ON <input checked="" type="radio"/>
Ch3	08, -10V~10V	OFF <input type="radio"/> ON <input checked="" type="radio"/>
Ch4	08, -10V~10V	OFF <input type="radio"/> ON <input checked="" type="radio"/>
Ch5	08, -10V~10V	OFF <input type="radio"/> ON <input checked="" type="radio"/>
Ch6	08, -10V~10V	OFF <input type="radio"/> ON <input checked="" type="radio"/>
Ch7	08, -10V~10V	OFF <input type="radio"/> ON <input checked="" type="radio"/>

Modbus Address	Function	Action
00628	Normal(16 bits & 10Hz)/Fast mode(12 bits & 60Hz) for AI	OFF <input checked="" type="radio"/> ON <input type="radio"/> 0=Normal/1=Fast (default=0)
00629	60/50Hz rejection for AI	OFF <input checked="" type="radio"/> ON <input type="radio"/> 0=60Hz/1=50Hz (default=0)
00631	AI Data Format	OFF <input checked="" type="radio"/> ON <input type="radio"/> 0=Hex/1=Engineering (default=0)
00632	Recover AI Calibration Values to Factory Setting	<input type="checkbox"/>

## 6. MiniOS7 Utility Tools

MiniOS7 Utility is a tool for uploading firmware to flash memory and updating the OS to ET-7X00/PET-7X00 module embedded with MiniOS7 with easiness and quickness.

If you haven't the MiniOS7 Utility installed on your system, installation of the MiniOS7 Utility should be the first step. Please refer to section "2.4 Installing the MiniOS7 Utility" to install it.

### 6.1. Establishing a Connection

To upload firmware or update the OS to ET-7X00/PET-7X00 module, you must first establish a connection between PC and the ET-7X00/PET-7X00 module.

#### Step 1 : Run the MiniOS7 Utility

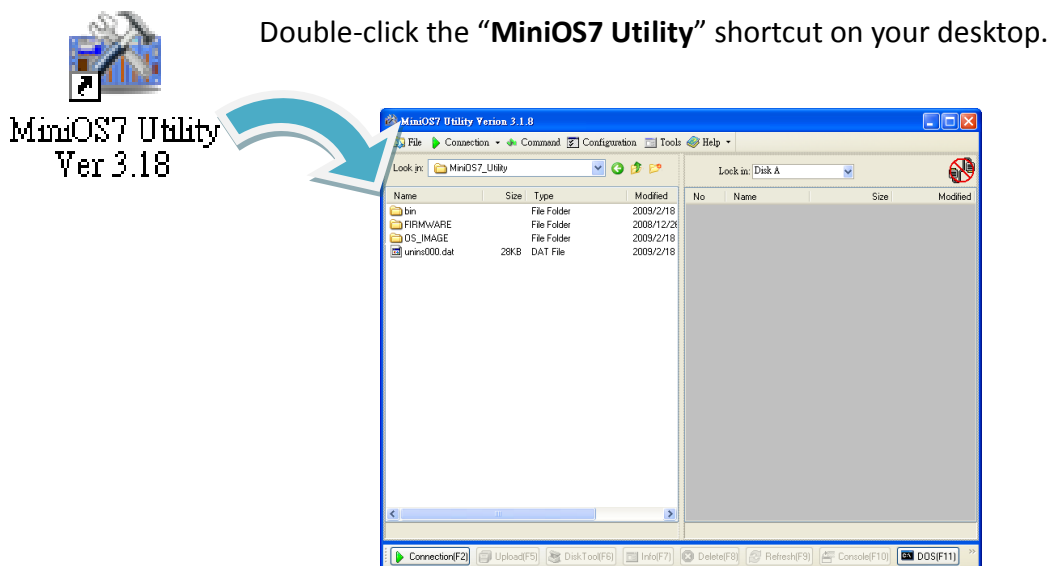

**Step 2 : Press the “F12” key or choose the “Search” option from the “Connection” menu**

After pressing the “F12” key or choosing the “Search” option from “Connection” menu, the utility perform a search of all MiniOS7 modules on your network.

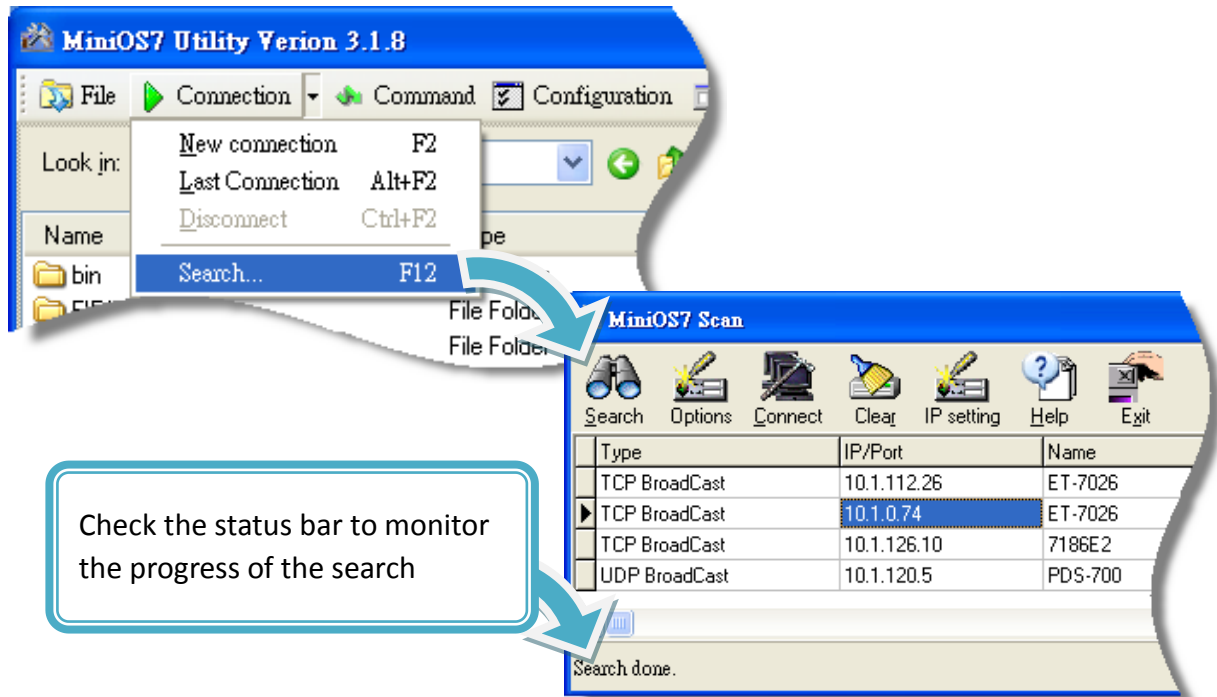

**Step 3 : Click the IP address in the IP/Port field list and then click the “Connect” icon in the toolbar**

After the search has been completed, click the IP address for the ET-7X00/PET-7X00 module in the IP/Port field list and then click the “Connect” icon in the toolbar to connect to the ET-7X00/PET-7X00.

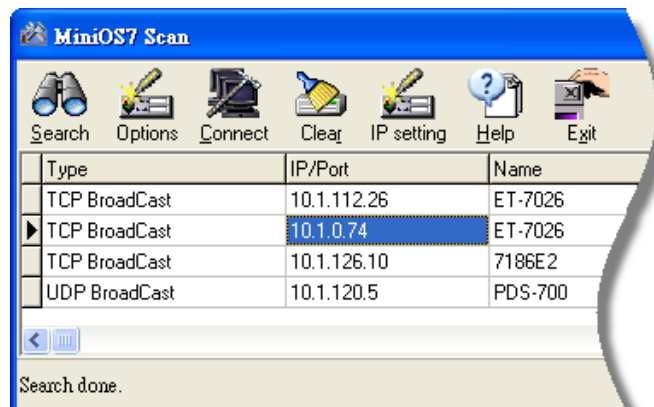

**Step 4 : Check the connection symbol to make sure that the connection is established**

A connection symbol Check the connection symbol status in the top right side to make sure the connection has been established

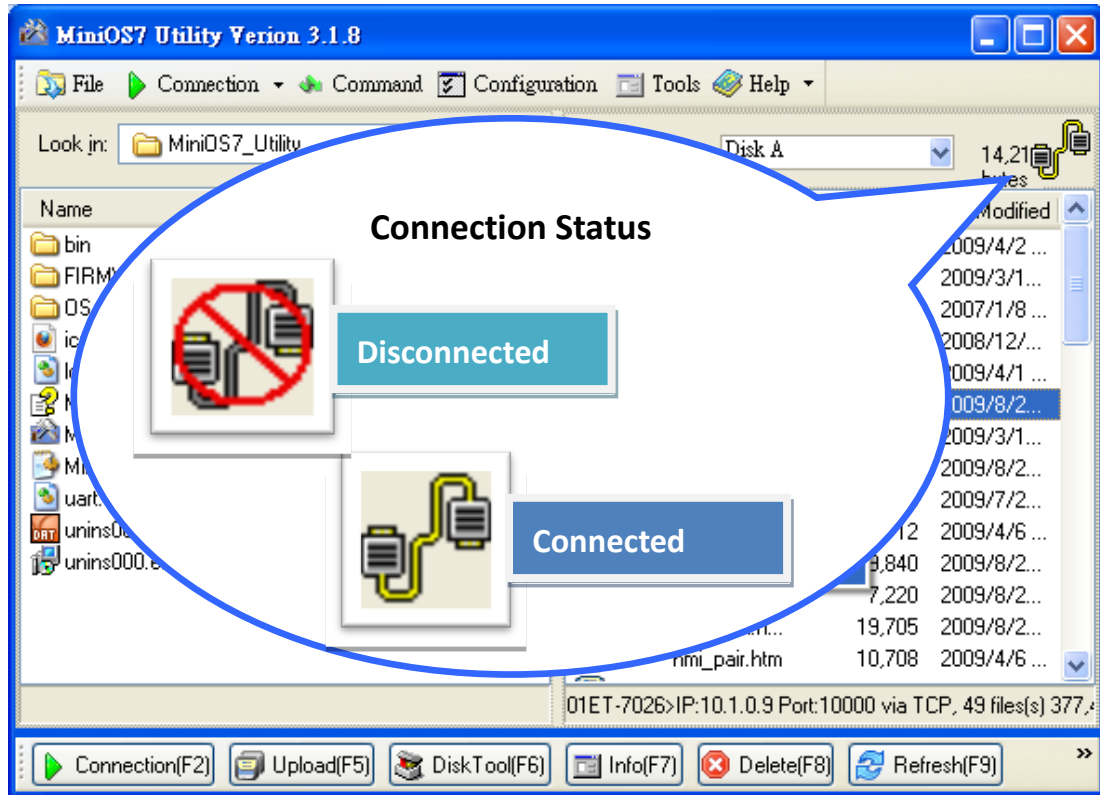

## 6.2. Exchanging the Protocol (TCP/IP to UDP)

MiniOS7 Utility supports both UDP and TCP protocols. For MiniOS7 Utility, the TCP/IP is the default protocol for communicating with ET-7X00/PET-7X00, and the UDP is used to update the OS. Therefore, if you want to update the OS, you might need to change protocols to support them.

### Step 1 : Establish a connection to the ET-7X00/PET-7X00

For a more detailed description of this instruction, please refer to section “6.1. Establishing a Connection”.

### Step 2 : Right Click the file list of the right side window, and then choose “Quit Firmware” to stop the firmware running

Right click the file list of the right side windows, and then choose “Quit Firmware” to stop the firmware running and exchange TCP/IP protocol to UDP protocol.

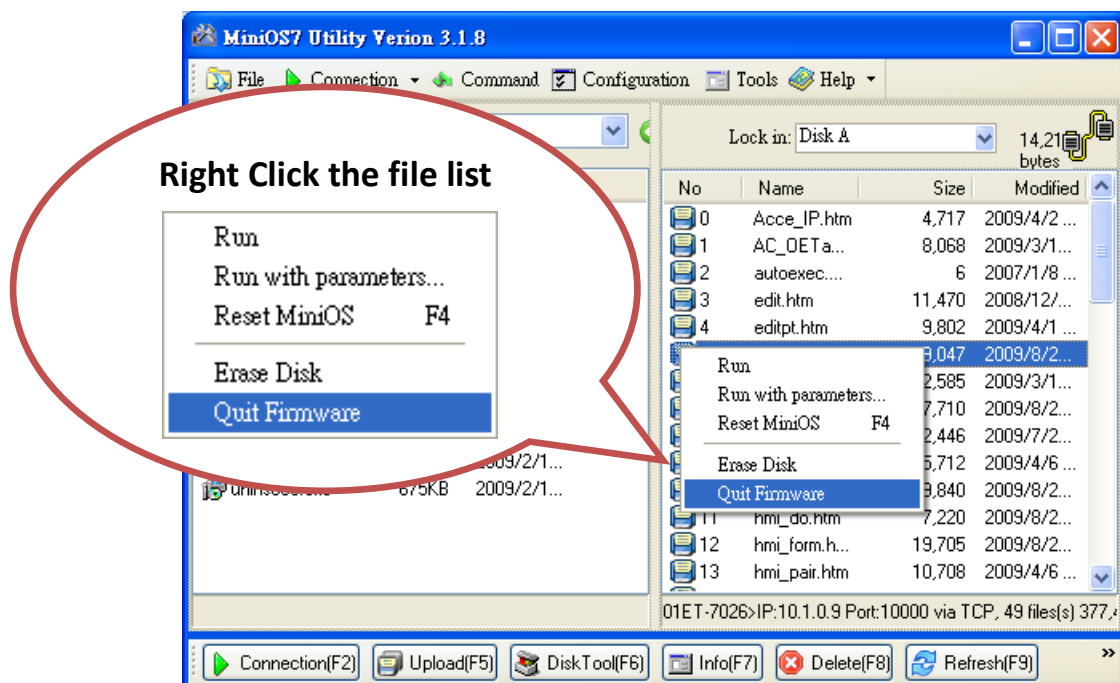

### Step 3 : Click the “Yes” button to continue

After executing the Quick Firmware command, the “Confirm” dialog will appear, and then click “Yes” button to continue and stop the firmware running.

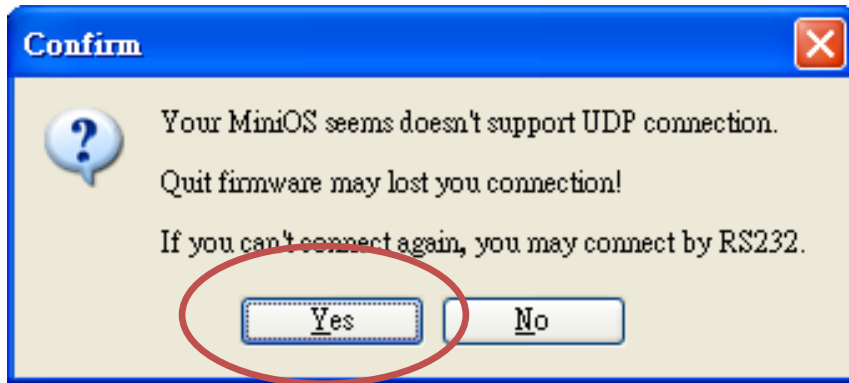

### Step 4 : Click “Yes” to continue

After confirming the command, the “Confirm” dialog will appear, and then click “Yes” button to exchange UDP protocol for TCP protocol.

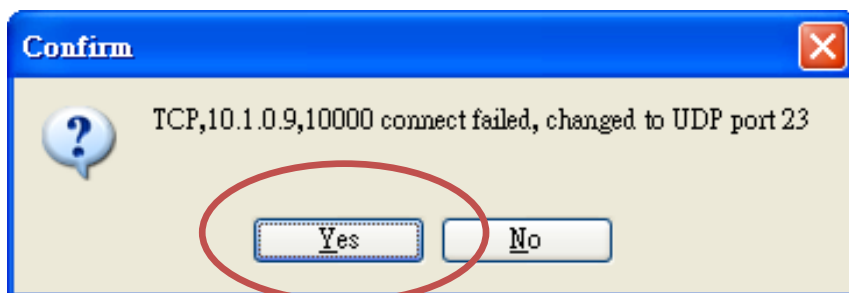

### Step 5 : The changes have been affected

## 6.3. Updating the ET-7X00/PET-7X00 OS

Additional features to ET-7X00/PET-7X00 OS will continue to be added in the future, so we advise you to periodically check with ICPDAS web site for the latest updates.

### Step 1 : Download the latest version of the MiniOS7 OS image

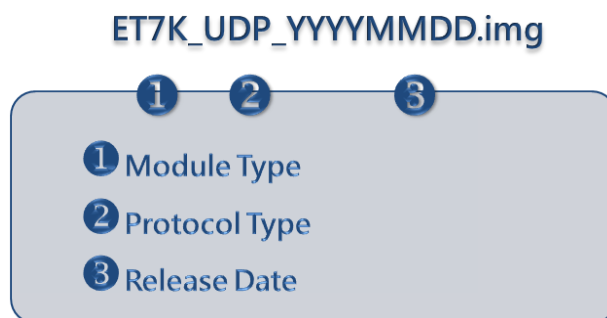

#### For ET-7000/PET-7000 series module:

The latest version of the MiniOS7 OS image can be obtained from the companion CD:

CD:\NAPDOS\ET7000\_ET7200\os\_image\ET7000\_PET7000\

or from the ICP DAS FTP site at:

[ftp://ftp.icpdas.com/pub/cd/6000cd/napdos/et7000\\_et7200/os\\_image/et7000\\_pet7000/](ftp://ftp.icpdas.com/pub/cd/6000cd/napdos/et7000_et7200/os_image/et7000_pet7000/)

#### For ET-7200/PET-7200 series module:

The latest version of the MiniOS7 OS image can be obtained from the companion CD:

CD:\NAPDOS\ET7000\_ET7200\os\_image\ET7200\_PET7200\

or from the ICP DAS FTP site at:

[ftp://ftp.icpdas.com/pub/cd/6000cd/napdos/et7000\\_et7200/os\\_image/et7200\\_pet7200/](ftp://ftp.icpdas.com/pub/cd/6000cd/napdos/et7000_et7200/os_image/et7200_pet7200/)



**Step 2 : Be sure that the switch is set to the “Init” position and then reboot the module**

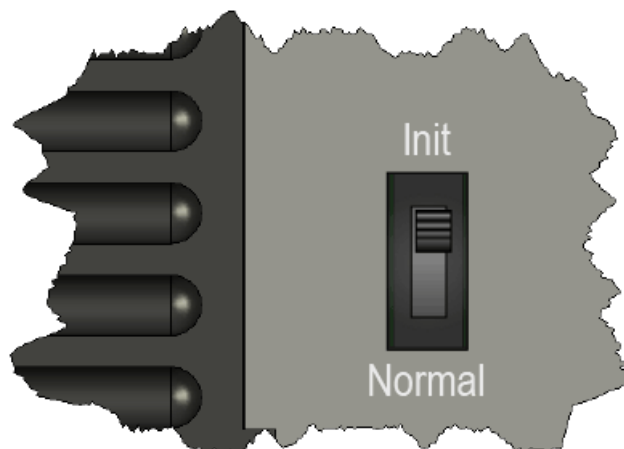

**Step 3 : Establish a connection to ET-7X00/PET-7X00**

For a more detailed description of this instruction, please refer to section “6.1. Establishing a Connection”.

**Step 4 : Choose “Update MiniOS7 Image” from the “File” menu**

Choose “Update MiniOS7 Image” from File menu to start the update procedure.

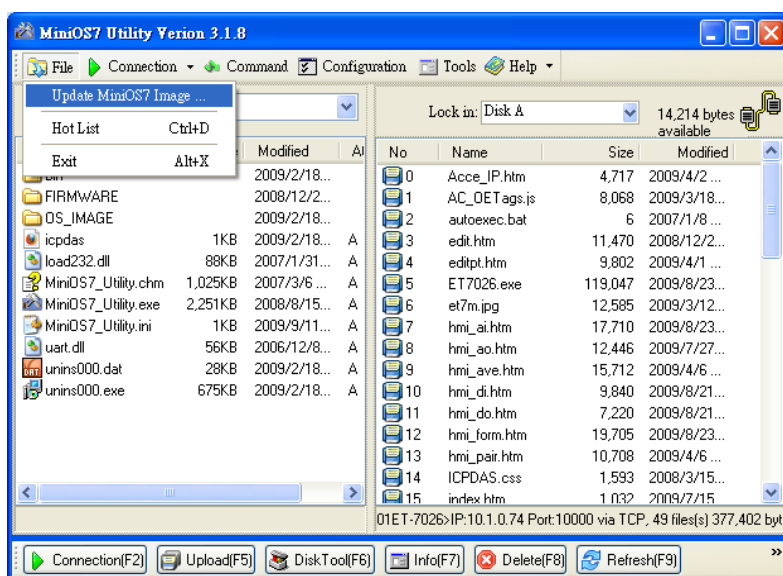

**Step 5 : Select the latest version of the MiniOS7 OS image**

After choosing the update MiniOS7 Image command, the “Select MiniOS7 Image file” dialog will appear, and then select the latest version of the MiniOS7 OS image.

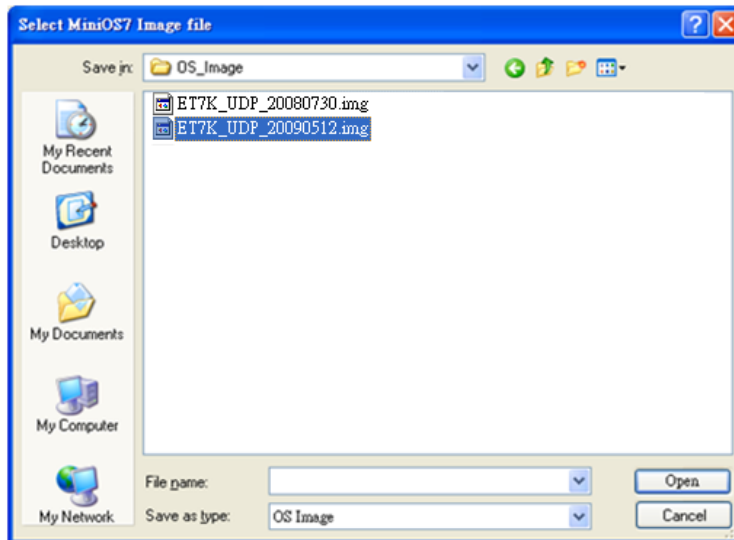

**Step 6 : Click “OK” to finish the procedure**

After confirming the command, you just need to wait awhile until the following dialog appear, and then click “OK” button to finish the procedure.

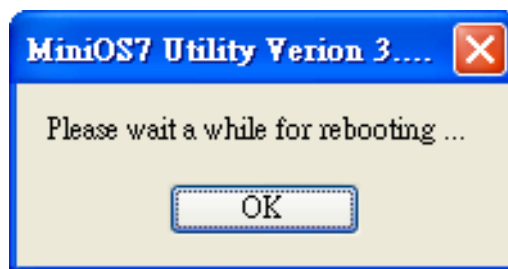

**Step 7 : Press “F7” or choose “Info” from the “Command” menu to check the OS version**

After pressing “F7” or choosing info from “Command” menu to check the OS version.

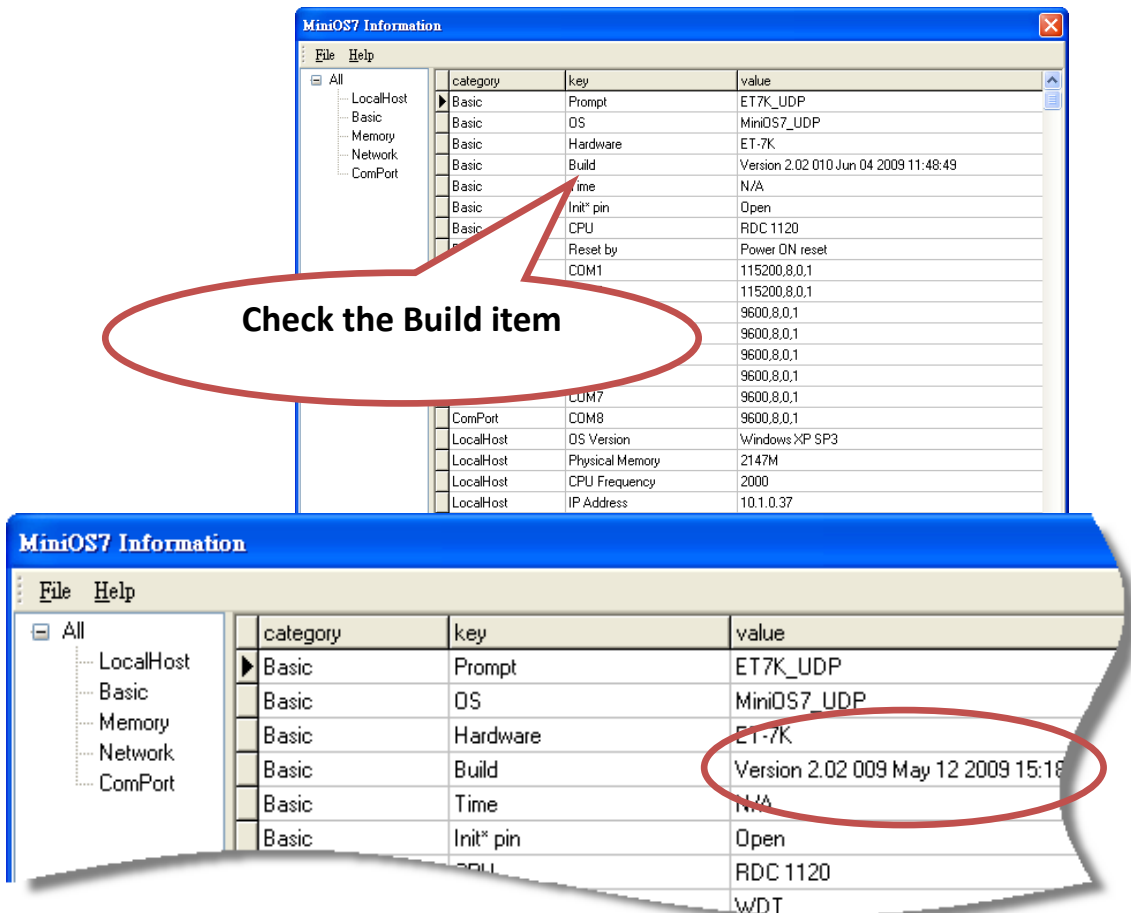

## 6.4. Updating the ET-7X00/PET-7X00 Firmware

The firmware is stored in flash memory and can be updated to fix functionality issues or add additional features, so we advise you to periodically check the ICP DAS web site for the latest updates.

### Step 1 : Download the latest version of the firmware

#### ET-7X00

---



The latest version of the ET-7000 firmware can be obtained from:

CD:\NAPDOS\ET7000\_ET7200\firmware\ET7000\

[ftp://ftp.icpdas.com/pub/cd/6000cd/napdos/et7000\\_et7200/firmware/et7000/](ftp://ftp.icpdas.com/pub/cd/6000cd/napdos/et7000_et7200/firmware/et7000/)

#### PET-7X00

---

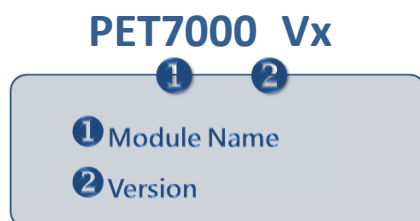

The latest version of the PET-7000 firmware can be obtained from:

CD:\NAPDOS\ET7000\_ET7200\firmware\PET7000\

[ftp://ftp.icpdas.com/pub/cd/6000cd/napdos/et7000\\_et7200/firmware/pet7000/](ftp://ftp.icpdas.com/pub/cd/6000cd/napdos/et7000_et7200/firmware/pet7000/)

## PET7000 Vx

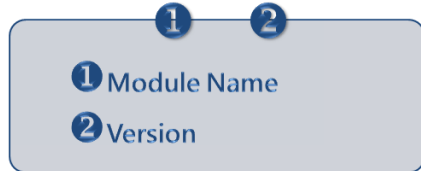

The latest version of the ET-7200/PET-7200 firmware can be obtained from:

CD:\NAPDOS\ET7000\_ET7200\firmware\ET7200\_PET7200\

<ftp://ftp.icpdas.com/pub/cd/6000cd/napdos/pet7000/firmware/>

[ftp://ftp.icpdas.com/pub/cd/6000cd/napdos/et7000\\_et7200/firmware/et7200\\_pet7200/](ftp://ftp.icpdas.com/pub/cd/6000cd/napdos/et7000_et7200/firmware/et7200_pet7200/)

**Step 2 : Be sure that the switch is set to the “Init” position and then reboot the module**

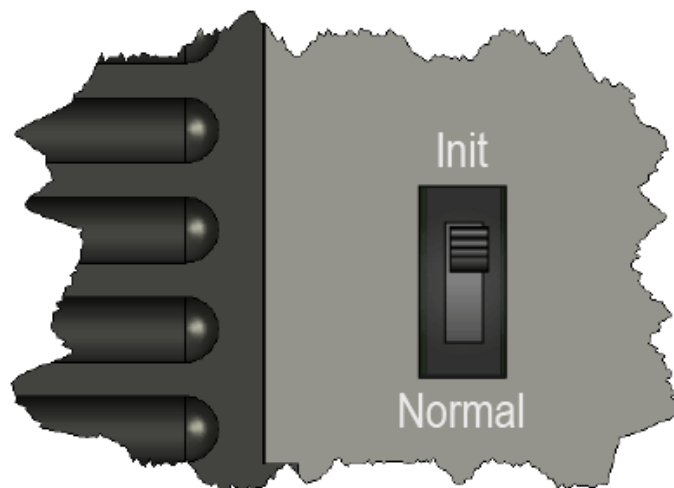

**Step 3 : Establish a connection to connection to the ET-7X00/PET-7X00**

For a more detailed description of this instruction, please refer to section “6.1. Establishing a Connection”.

#### Step 4 : Choose “Erase Disk” from the “Command” menu

After establishing a connection, then choose “Erase Disk” from Command menu (or right-click on the right of window) to erase the contents of the flash memory.

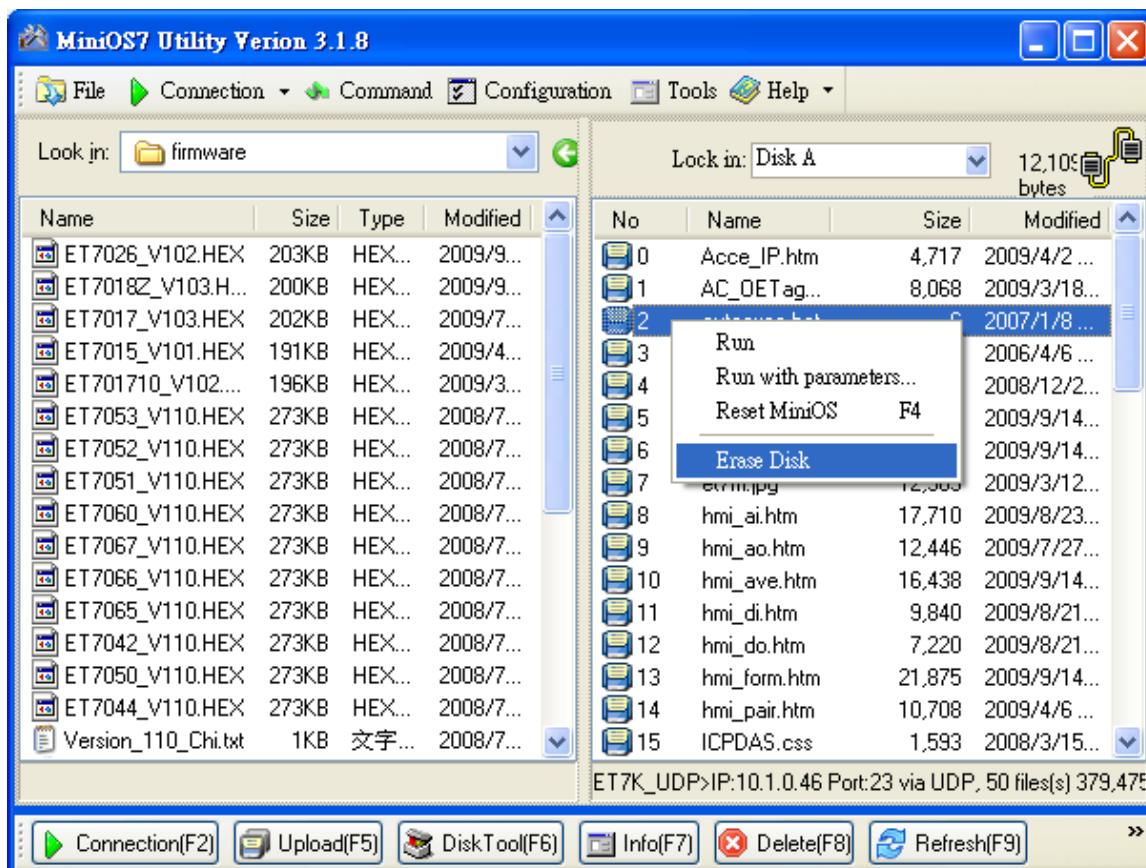

#### Tips & Warnings



You have to delete all files existed on the ET-7X00/PET-7X00 before uploading the firmware.

**Step 5 :** In the Confirm dialog box, click the “Yes” button to continue.

After executing the Erase Disk command, the Confirm dialog will appear, and then click “Yes” button to continue erasing the memory contents.

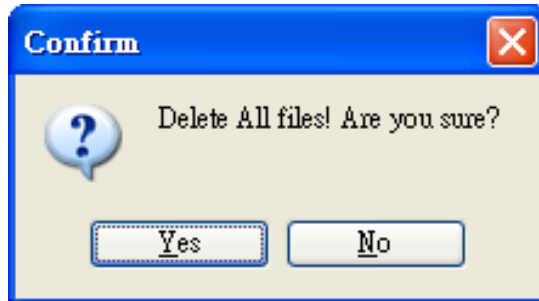

**Step 6 :** Select the latest version of the firmware.

Upload the last version of the firmware to the ET-7X00/PET-7X00 using drag-and-drop operation.

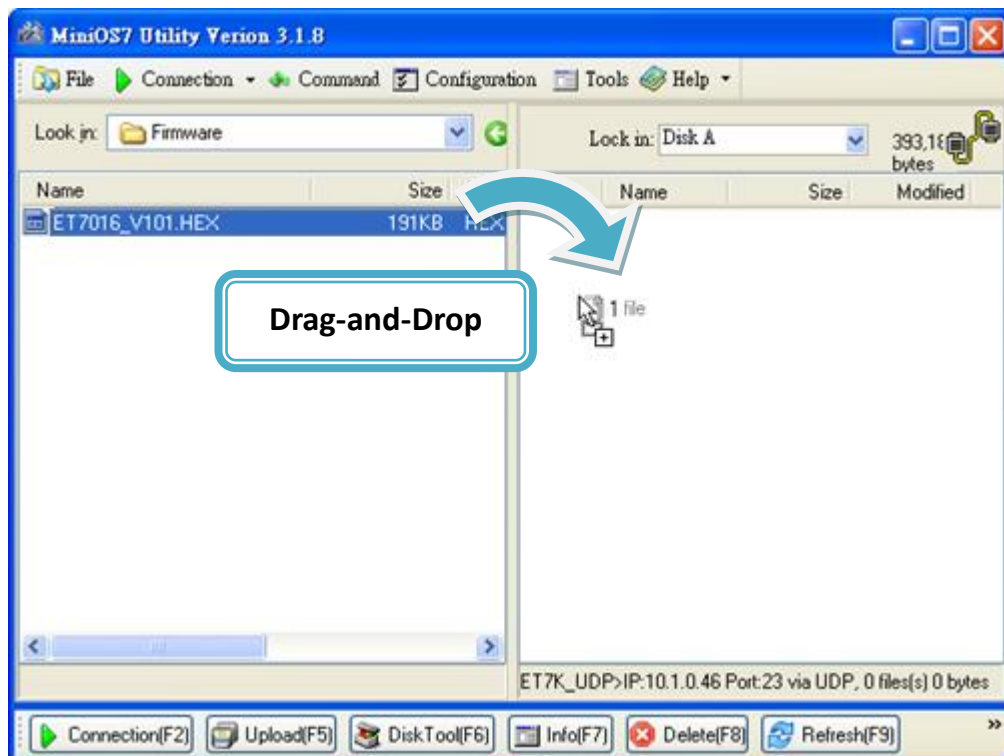

**Step 7 : Click “OK” to finish and reboot the module.**

After confirming the command, you just need to wait awhile until the following dialog appear, and then click “OK” button to finish the procedure. After the update is completed, set the switch (on the back of the module) to the "Normal" position.

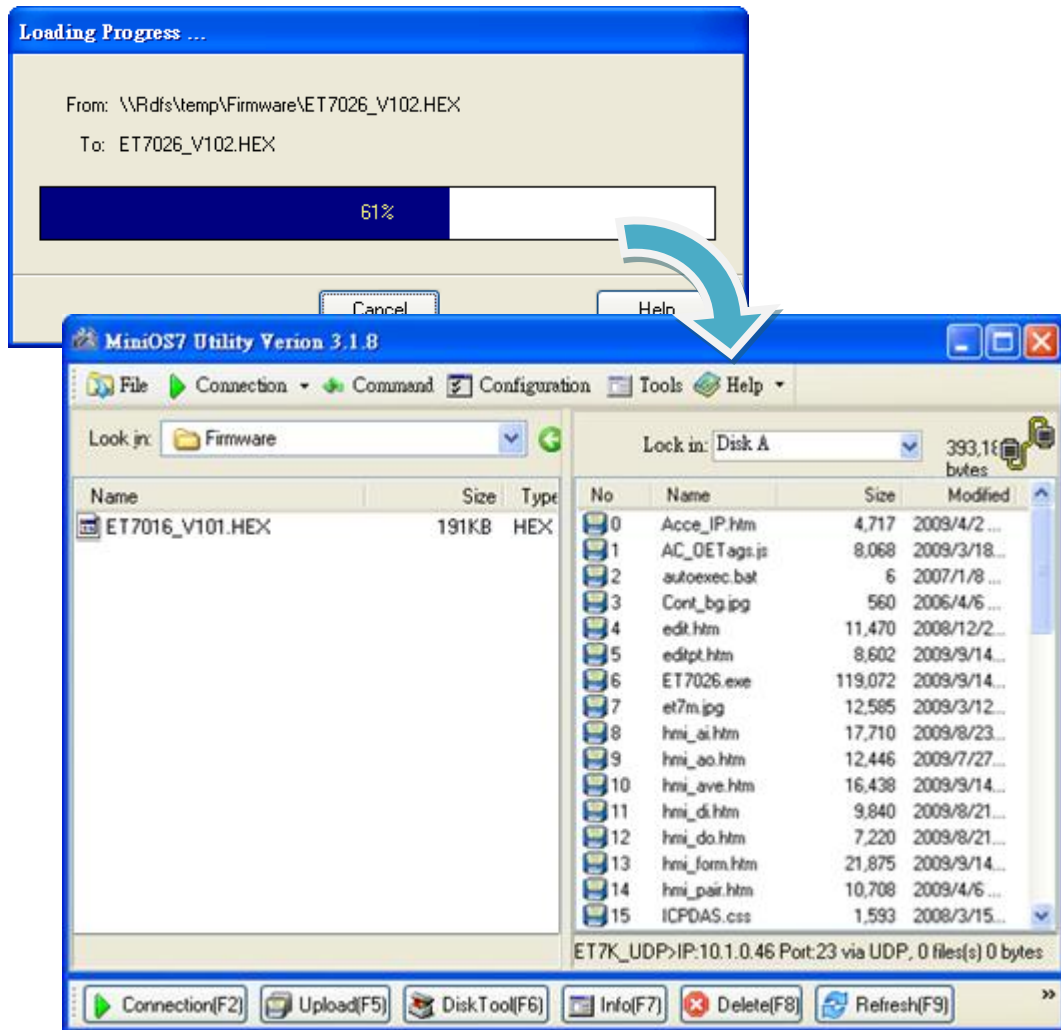



## 7. External Tools and Tasks

ET-7X00/PET-7X00 supports a number of external tools to aid in developing your applications

### 7.1. LabVIEW

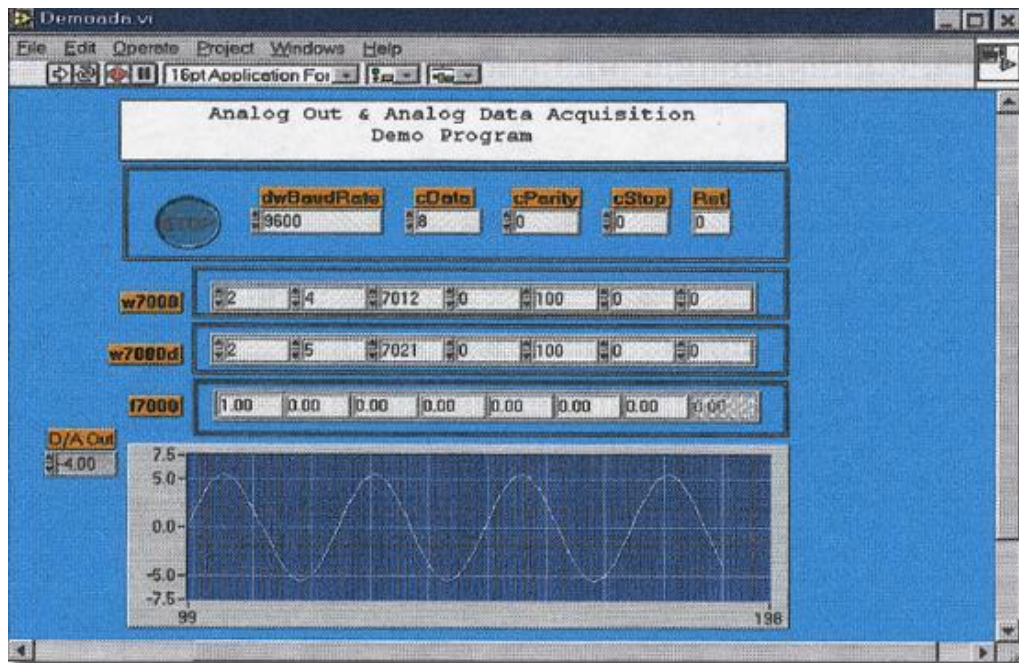

LabVIEW is the best way to acquire, analyze, and present data. LabVIEW delivers a graphical development environment that can be used to quickly build data acquisition quickly, instrumentation and control systems, boosting productivity and saving development time. With LabVIEW, it is possible to quickly create user interfaces that enable interactive control of software systems. To specify your system functionality, simply assemble block diagram – a natural design notation for scientists and engineers.

The document containing the detailed instructions for linking to the ET-7X00/PET-7X00 using the Modbus protocol is located on the shipped

CD:\NAPDOS\ET7000\_ET7200\document\application\LabVIEW\ or

[ftp://ftp.icpdas.com/pub/cd/6000cd/napdos/et7000\\_et7200/document/application/labview/](ftp://ftp.icpdas.com/pub/cd/6000cd/napdos/et7000_et7200/document/application/labview/)

## 7.2. OPC Server

OPC (OLE for Process Control) is the first standard resulting from the collaboration of a number of leading worldwide automation suppliers working in cooperation with Microsoft. Originally based on Microsoft's OLE COM (Component Object Model) and DCOM (Distributed Component Object Model) technologies, the specification defines a standard set of objects, interfaces and methods for use in process control and manufacturing automation applications to facilitate interoperability.

There are many different mechanisms provided by various vendors that allow access to a variety of devices via specific applications. However, if an OPC Server is provided for the device, other applications will be able to access the OPC Server via the OPC interface.

## 7.3. SCADA

SCADA stands for Supervisor Control and Data Acquisition. It is a production automation and control system based on PCs.

SCADA is widely used in many fields e.g. power generation, water systems, the oil industry, chemistry, the automobile industry. Different fields require different functions, but they all have the common features:

- Graphic interface
- Process mimicking
- Real time and historic trend data
- Alarm system
- Data acquisition and recording
- Data analysis
- Report generator

### **Accessing ET-7X00/PET-7X00 module**

---

SCADA software is able to access ET-7X00/PET-7X00 devices using Modbus communication protocols, and can communicate without the need for other software drivers.

### **Famous SCADA software**

---

Citect, ICONICS, iFIX, InduSoft, Intouch, Entivity Studio, Entivity Live, Entivity VLC, Trace Mode, Wizcon, Wonderware ... etc

In the following sections 3 popular brands of SCADA software are introduced together with the detailed instructions in how use them to communicate with ET-7X00/PET-7X00 module using the Modbus/TCP protocol.

### 7.3.1. InduSoft

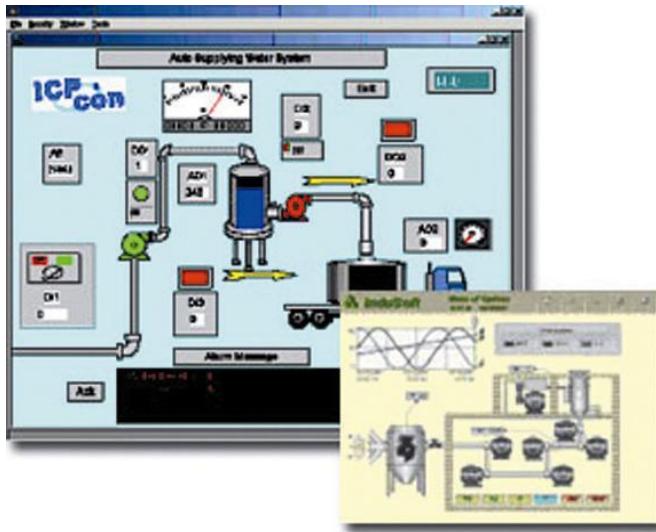

InduSoft Web Studio is a powerful, integrated collection of automation tools that includes all the building blocks needed to develop modern Human Machine Interfaces (HMI), Supervisory Control and Data Acquisition (SCADA) systems, and embedded instrumentation and control applications. InduSoft Web Studio's application runs in native Windows NT, 2000, XP, CE and CE .NET environments and conforms to industry standards such as

Microsoft .NET, OPC, DDE, ODBC, XML, and ActiveX.

The document containing detailed instructions for linking to the ET-7X00/PET-7X00 module using the Modbus protocol is located on the shipped

CD:\NAPDOS\ET7000\_ET7200\document\application\InduSoft\

[ftp://ftp.icpdas.com/pub/cd/6000cd/napdos/et7000\\_et7200/document/application/indusoft/](ftp://ftp.icpdas.com/pub/cd/6000cd/napdos/et7000_et7200/document/application/indusoft/)

### 7.3.2. Citect

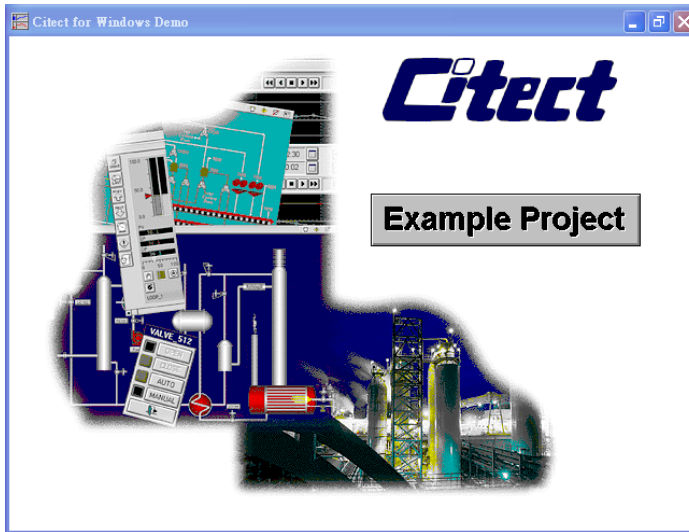

CitectSCADA is a fully integrated Human Machine Interface (HMI) / SCADA solution that enables users to increase return on assets by delivering a highly scalable, reliable control and monitoring system. Easy-to-use configuration tools and powerful features enable rapid development and deployment of solutions for any size application.

The document containing detailed instructions for linking to the ET-7X00/PET-7X00 module using the Modbus protocol is located on the shipped

CD:\NAPDOS\ET7000\_ET7200\document\application\Citect\

[ftp://ftp.icpdas.com/pub/cd/6000cd/napdos/et7000\\_et7200/document/application/citect/](ftp://ftp.icpdas.com/pub/cd/6000cd/napdos/et7000_et7200/document/application/citect/)

### 7.3.3. iFix



The document containing detailed instructions for linking to the ET-7X00/PET-7X00 module using the Modbus protocol is located on the shipped

CD:\NAPDOS\ET7000\_ET7200\document\application\iFix\

[ftp://ftp.icpdas.com/pub/cd/6000cd/napdos/et7000\\_et7200/document/application/ifix/](ftp://ftp.icpdas.com/pub/cd/6000cd/napdos/et7000_et7200/document/application/ifix/)

# Appendix A. Node Information Area

Each ET-7000/PET-7000 module has a built-in EEPROM to store configuration information such as IP address, type code, etc. One minor drawback is that there are no visual indications of the configuration of the module. New ET-7000/PET-7000 modules include node information areas that are protected by a cover, as shown below, and can be used to make a written record of the node information, such as IP address, etc. To access the node information areas, first slide the covers outward, as shown in the figure below.

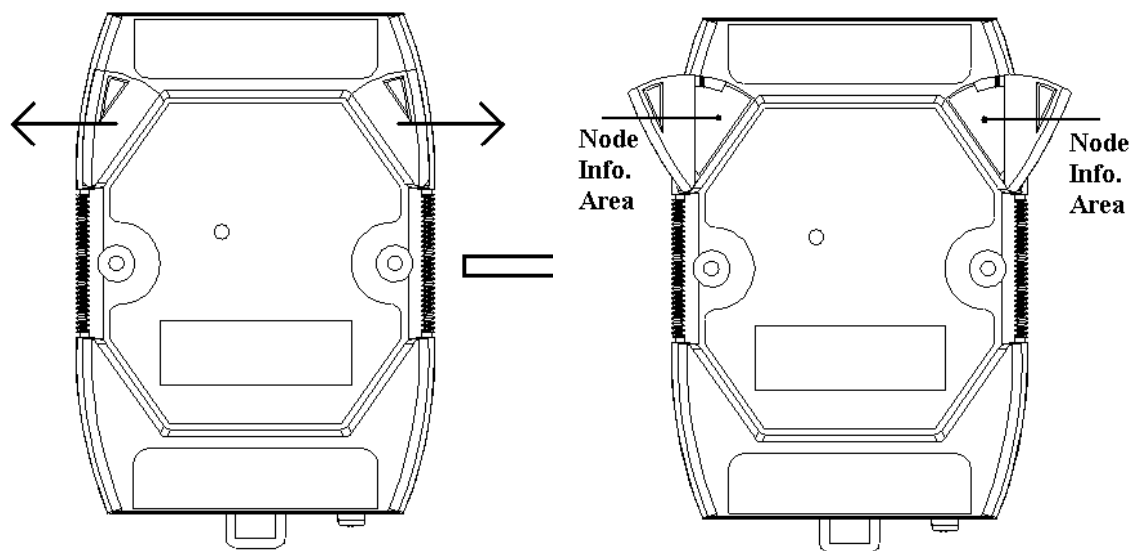

## Appendix B. Thermocouple

When two wires composed of dissimilar homogeneous metals are joined at one end, a thermoelectric electromotive force (emf) appears that depends only on the metals and the junction temperature. This is called the Seebeck effect. A pair of different metals with a fixed junction at one end constitutes a thermocouple. For small changes in temperature, the emf is linearly proportional to the temperature. This implies that the temperature reading can be obtained by measuring the emf.

We cannot measure the emf,  $V_1$ , directly because when a voltmeter is connected to the thermocouple, another emf,  $V_2$ , is created at the (cold) junction of the thermocouple and the voltmeter. The cold junction compensation method is used to resolve the problem. Using another sensor, e.g. a thermistor, to measure the cold junction temperature,  $T_2$ , we can calculate the emf,  $V_2$ , which corresponds to  $T_2$ . The thermocouple emf,  $V_1$ , can be obtained by adding  $V_2$  to that measured by the voltmeter and then the temperature.



# Appendix C. Modbus Application Notes

## C.1. Dual Watchdog

The Dual Watchdog consists of Module Watchdog and Host Watchdog.

1. **The Module Watchdog** is a built-in hardware circuit that will reset the CPU module if a failure occurs in either the hardware or the software. If the application does not refresh the watchdog timer within 0.8 seconds, the watchdog circuit will initiate a reset of the CPU.

2. **The Host Watchdog** is a software function that can be used to monitor the operating status of the host. Its purpose is to prevent network communication problems or a host failure. If the Watchdog timeout interval expires, the module will return all outputs to a predefined Safe value (Refer to the Safe Value application note), which can prevent the controlled target from unexpected situation.

AO address 40557 of the ET-7X00/PET-7X00 Modbus register is the address of the Host Watchdog timer, and will be stored in EEPROM. The WDT function will be disabled if the value is set to less than 5 seconds.

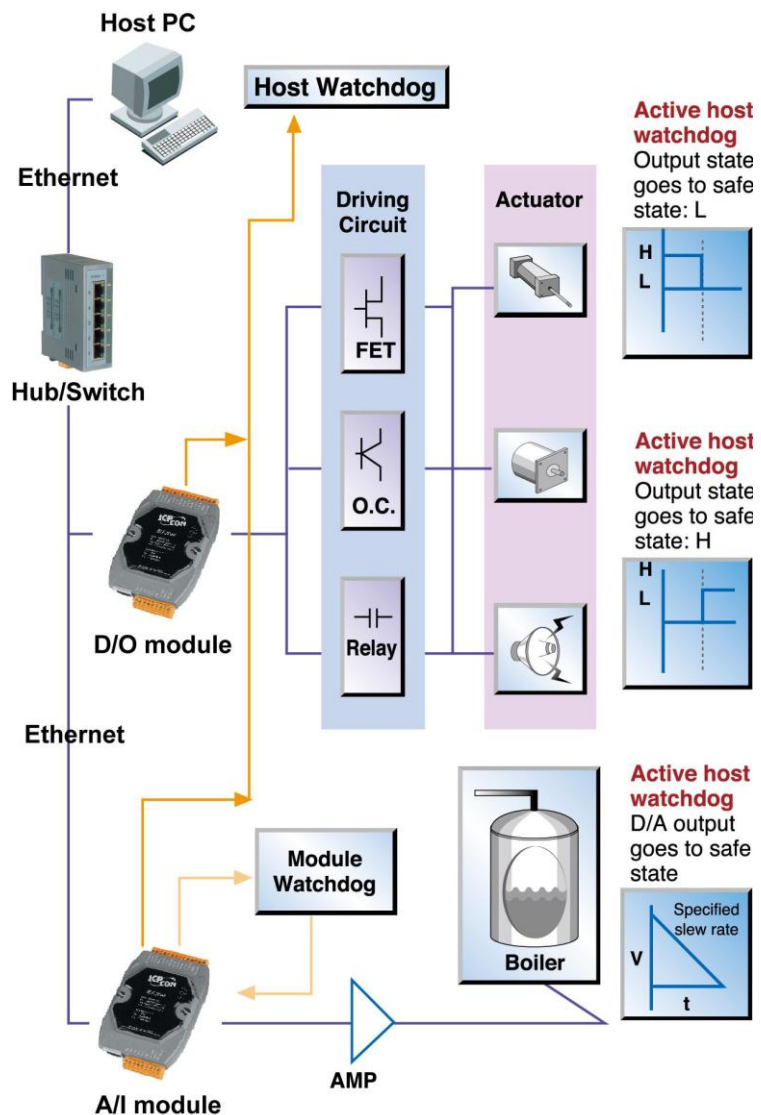

## C.2. Power-on Value

Many industrial applications require a "safe" start-up condition to prevent accidents at critical points in the process. Each ET-7X00/PET-7X00 contains an initial power-on value which is used to configure the analog/digital outputs on power up. In other words, power-on value can be considered as a start-up value. The power-on value is loaded into the output modules under 3 conditions: power on, reset by Module Watchdog, reset by the reset command.

User can set the power-on value of the specific analog/digital output channel and the power-on value is stored in EEPROM.

### Setting the Power-on Value for a Specific Digital Output Channel

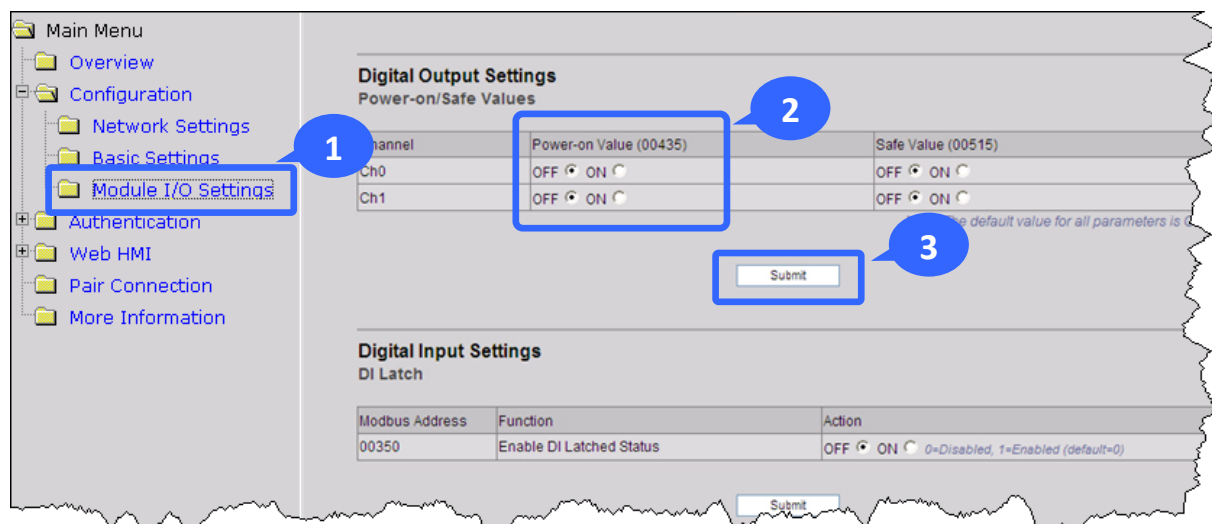

**Step 1** : Log into the ET-7X00/PET-7X00 web page, and then click the “**Module I/O Settings**” option in the “**Configuration**” section of the Main Menu

**Step 2** : Enable the Power-on Value by checking the “**ON**” radio button

**Step 3** : Click the “**Submit**” button to complete the configuration of the power-on Value

## Setting the Power-on Value for a Specific Analog Output Channel

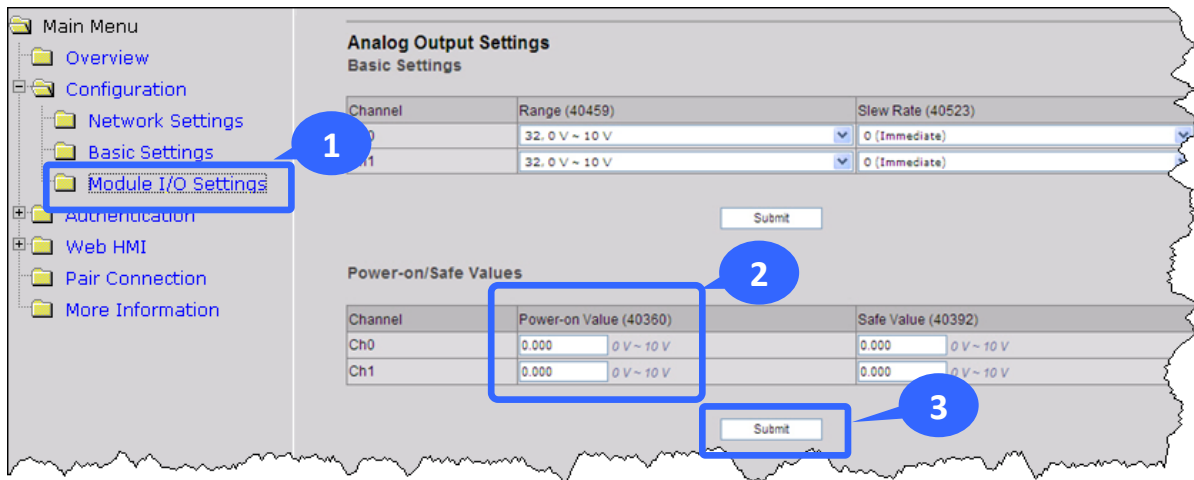

**Step 1 :** Log into the ET-7X00/PET-7X00 web page, and then click the “**Module I/O Settings**” option in the “**Configuration**” section of the Main Menu

**Step 2 :** Set the Power-on Value in the “**Power-on Value**” text box

**Step 3 :** Click the “**Submit**” button to complete the configuration of the Power-on Value and save the settings to the EEPROM

## C.3. Safe Value

When the Host Watchdog is enabled and the communication between host PC and ET-7X00/PET-7X00 modules is broken, the analog/digital output channels can generate a predefined value to prevent unpredictable damage of the connected devices. By default, this feature is disabled. User can enable this feature by configuring the Host WDT Timeout.

### Setting the Safe Value for a Specific Digital Output Channel

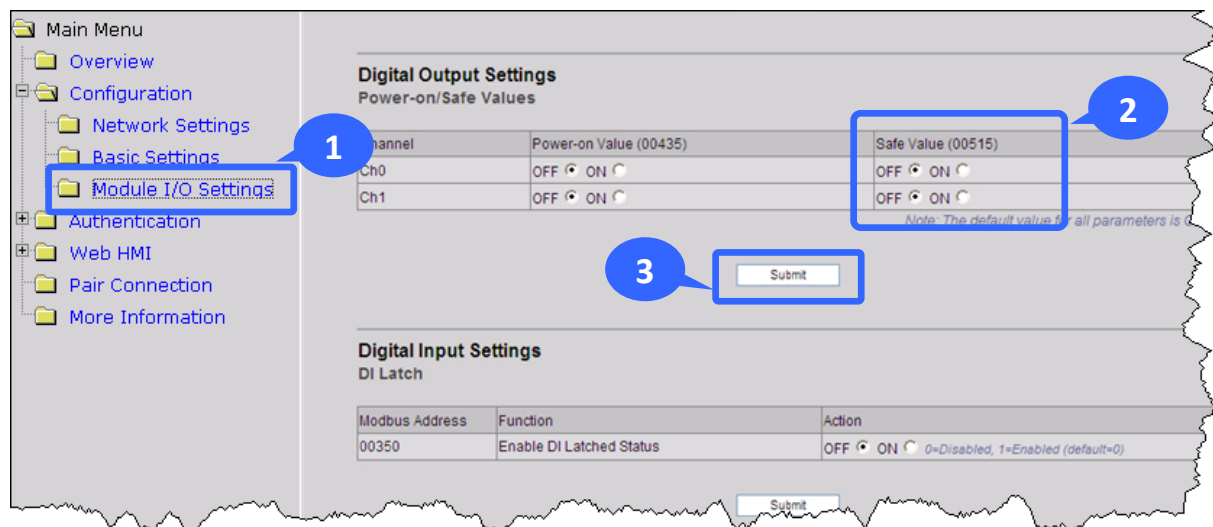

**Step 1 :** Log into the ET-7X00/PET-7X00 web page, and then click the “**Module I/O Settings**” option in the “**Configuration**” section of the Main Menu

**Step 2 :** Enable the Safe Value by checking the “**ON**” radio button

**Step 3 :** Click the “**Submit**” button to complete the configuration of the power-on Value

## Setting the Safe Value for a Specific Analog Output Channel

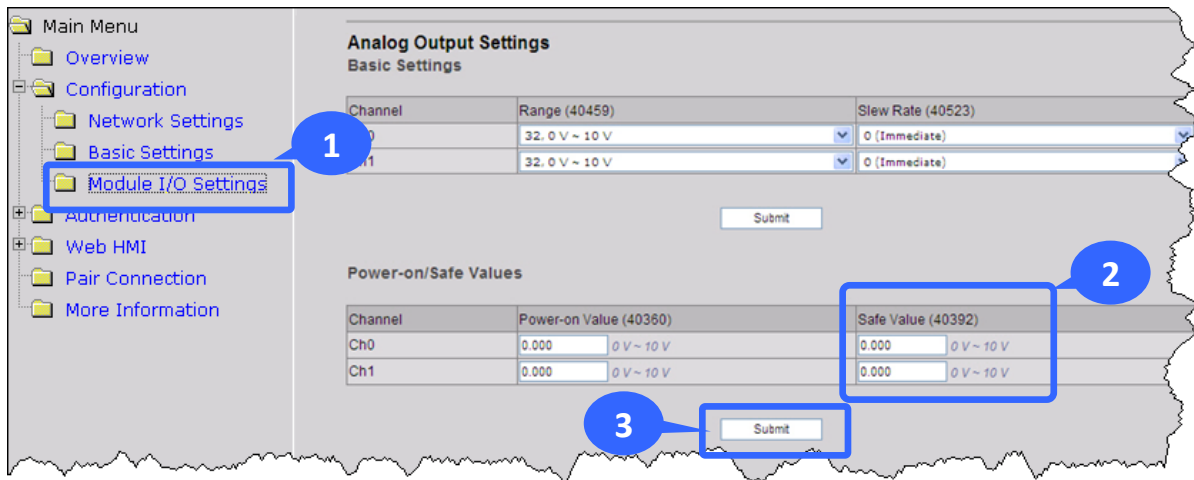

**Step 1** : Log into the ET-7X00/PET-7X00 web page, and then click the “**Module I/O Settings**” option in the “**Configuration**” section of the Main Menu

**Step 2** : Set the Safe Value in the “**Safe Value**” text box

**Step 3** : Click the “**Submit**” button to complete the configuration of the Safe Value and save the settings to the EEPROM

## C.4. AI High/Low Alarm

ET-7X00/PET-7X00 module equip with the High/Low Alarm function. When the alarm function is enabled, the specific registers are the alarm indicator. The alarm function is to compare the analog input value with given high alarm value and low alarm value.

Address 00636 to 00667 can be used to enable/disable the AI High Alarm function.

Address 00668 to 00699 can be used to enable/disable the AI Low Alarm function.

### AI High/Low Alarm Switch Table

Channel Number	AI High Alarm		AI Low Alarm	
	Register	Description	Register	Description
AI0	00636	0: Disable/1: Enable	00668	0: Disable/1: Enable
AI1	00637	0: Disable/1: Enable	00669	0: Disable/1: Enable
AI2	00638	0: Disable/1: Enable	00670	0: Disable/1: Enable
AI3	00639	0: Disable/1: Enable	00671	0: Disable/1: Enable
AI4	00640	0: Disable/1: Enable	00672	0: Disable/1: Enable
AI5	00641	0: Disable/1: Enable	00673	0: Disable/1: Enable
AI6	00642	0: Disable/1: Enable	00674	0: Disable/1: Enable
AI7	00643	0: Disable/1: Enable	00675	0: Disable/1: Enable
AI8	00644	0: Disable/1: Enable	00676	0: Disable/1: Enable
AI9	00645	0: Disable/1: Enable	00677	0: Disable/1: Enable

Address 40296 to 40327 records the High Alarm value. Address 40328 to 40359 records the Low Alarm value. By default, the High Alarm value is +32767 (0x7FFF) and the low alarm value is -32768 (0xFFFF).

### AI High/Low Alarm Value Table

Channel Number	High Alarm Value of AI		Low Alarm Value of AI	
	Register	Description	Register	Description
AI0	40296	-32768 ~ 32767	40328	-32768 ~ 32767
AI1	40297	-32768 ~ 32767	40329	-32768 ~ 32767
AI2	40298	-32768 ~ 32767	40330	-32768 ~ 32767
AI4	40300	-32768 ~ 32767	40332	-32768 ~ 32767
AI5	40301	-32768 ~ 32767	40333	-32768 ~ 32767
AI6	40302	-32768 ~ 32767	40334	-32768 ~ 32767
AI7	40303	-32768 ~ 32767	40335	-32768 ~ 32767
AI8	40304	-32768 ~ 32767	40336	-32768 ~ 32767
AI9	40305	-32768 ~ 32767	40337	-32768 ~ 32767

The analog input High/Low Alarm contains two alarm types, Momentary Alarm and Latch Alarm. Address 00700 of Modbus register can be used to set the High Alarm type of channel 0 and the total number of channels depends on the type of module. Address 00732 of Modbus register can be used to set the Low Alarm type of channel 0.

### AI High/Low Type Value Table

Channel Number	AI High Alarm Type		AI Low Alarm Type	
	Register	Description	Register	Description
A10	00700	0: Momentary Mode 1: Latch Mode	00732	0: Momentary Mode 1: Latch Mode
A11	00701	0: Momentary Mode 1: Latch Mode	00733	0: Momentary Mode 1: Latch Mode
A12	00702	0: Momentary Mode 1: Latch Mode	00734	0: Momentary Mode 1: Latch Mode
A13	00703	0: Momentary 1: Latched	00735	0: Momentary 1: Latched
A14	00704	0: Momentary 1: Latched	00736	0: Momentary 1: Latched
A15	00705	0: Momentary 1: Latched	00737	0: Momentary 1: Latched
A16	00706	0: Momentary 1: Latched	00738	0: Momentary 1: Latched
A17	00707	0: Momentary 1: Latched	00739	0: Momentary 1: Latched
A18	00708	0: Momentary 1: Latched	00740	0: Momentary 1: Latched
A19	00709	0: Momentary 1: Latched	00741	0: Momentary 1: Latched



The following are the descriptions for two alarm types.

## **Momentary Alarm**

The alarm status is cleared while the analog input is not exceeding the alarm value.

### For example:

If analog input value of channel 0 (30000) > High Alarm value (40296), the address 10224 is 1, else it is 0.

If analog input Value of channel 0 (30000) < Low Alarm value (40328), the address 10256 is 1, else it is 0.

The address 10224 to 10255 is the high alarm indicator. If a high alarm occurred, the value of register is 1. In normal condition, it will be 0. The address 10256 to 10287 is the low alarm indicator. If a low alarm occurred, the value of register is 1. In normal condition, it will be 0.

## **Latch Alarm**

When the Latch Alarm mode is enabled, the register stays latched until the specified registers are cleared.

### For example:

If analog input value of channel 0 (30000) > High Alarm value (40296), the address 10224 is 1, else if analog input value of channel 0 (30000) < Low Alarm value (40328), the address 10256 is 1.

The address 10224 to 10255 is the high alarm indicator. In normal condition, the value of register is 0. If a High alarm occurred, the value of register stays 1 until the address 00764 to 00795 is cleared. The address 10256 to 10287 is the low alarm indicator. In normal condition, the value of register is 0. If a low alarm occurred, the value of register stays 1 until the address 00796 to 00827 is cleared.

## Setting the High Alarm and Low Alarm for a Specific Analog Input Channel

The screenshot shows the 'Module I/O Settings' configuration page. The 'Alarm Settings' section contains the following table:

Channel	High Alarm			Low Alarm		
	Value (40296)	Enabled (00636)	Type (00700)	Value (40328)	Enabled (00668)	Type (00732)
Ch0	10.000	OFF <input checked="" type="radio"/> ON <input type="radio"/>	0 - Momentar	-10.000	OFF <input checked="" type="radio"/> ON <input type="radio"/>	0 - Momentar
Ch1	10.000	OFF <input checked="" type="radio"/> ON <input type="radio"/>	0 - Momentar	-10.000	OFF <input checked="" type="radio"/> ON <input type="radio"/>	0 - Momentar
Ch2	10.000	OFF <input checked="" type="radio"/> ON <input type="radio"/>	0 - Momentar	-10.000	OFF <input checked="" type="radio"/> ON <input type="radio"/>	0 - Momentar
Ch3	10.000	OFF <input checked="" type="radio"/> ON <input type="radio"/>	0 - Momentar	-10.000	OFF <input checked="" type="radio"/> ON <input type="radio"/>	0 - Momentar
Ch4	10.000	OFF <input checked="" type="radio"/> ON <input type="radio"/>	0 - Momentar	-10.000	OFF <input checked="" type="radio"/> ON <input type="radio"/>	0 - Momentar
Ch5	10.000	OFF <input checked="" type="radio"/> ON <input type="radio"/>	0 - Momentar	-10.000	OFF <input checked="" type="radio"/> ON <input type="radio"/>	0 - Momentar

Note: By default, the Alarm function is disabled and the Alarm Type is set to momentar.

**Step 1 :** Log into the ET-7X00/PET-7X00 web page, and then click the “**Module I/O Settings**” option in the “**Configuration**” section of the Main Menu

**Step 2 :** Set the High Alarm and Low Alarm information in the relevant field

**Step 3 :** Click the “**Submit**” button to complete the configuration of the High Alarm and the Low Alarm

## C.5. AI High/Low Latch

The address 30236 to 30267 records the maximum value of analog inputs and stays the value until another maximum input enters. The address 30268 to 30299 records the minimum value of analog inputs and stays the value until another minimum input enters.

### Monitoring the Alarm Status for a Specific Analog Input Channel

The screenshot displays the web interface for monitoring analog inputs. On the left, the 'Main Menu' includes 'Web HMI', which is highlighted with a blue box and a callout '1'. The main content area shows the 'Analog Input' table and the 'High/Low Latched Value for Analog Inputs' table, which is highlighted with a blue box and a callout '2'.

No	Register	Value	
		Hex Format	Floating Format
AI0	30000	FFFF	-0.000
AI1	30001	FFFF	-0.000
AI2	30002	0000	0.000
AI3	30003	0000	0.000
AI4	30004	FFFF	-0.000
AI5	30005	FFFF	-0.000

No	Latched High			Latched Low		
	Register	Value Hex Format	Value Floating Format	Register	Value Hex Format	Value Floating Format
AI0	30236	0005	0.001	30268	FFFB	-0.001
AI1	30237	0003	0.000	30269	FFFA	-0.001
AI2	30238	0006	0.001	30270	FFFA	-0.001
AI3	30239	0006	0.001	30271	FFFB	-0.001
AI4	30240	0004	0.001	30272	FFFA	-0.001
AI5	30241	0004	0.001	30273	FFFC	-0.001

**Step 1 :** Log into the ET-7X00/PET-7X00 web page, and then click the “**Web HMI**” option in the “**Web HMI**” section of the Main Menu

**Step 2 :** Monitor the alarm status by viewing the “**High/Low Latched Value for Analog Inputs**” group table

## Appendix D. Analog Input Type and Data Format Table

Type Code	Input Range	Data Format	+F.S	-F.S
00	-15 ~ +15 mA	Engineering Unit	+15000	-15000
		2's comp HEX	7FFF	8000
01	-50 ~ +50 mA	Engineering Unit	+5000	-5000
		2's comp HEX	7FFF	8000
02	-100 ~ +100 mV	Engineering Unit	+10000	-10000
		2's comp HEX	7FFF	8000
03	-500 ~ +500 mV	Engineering Unit	+5000	-5000
		2's comp HEX	7FFF	8000
04	-1 ~ +1 V	Engineering Unit	+10000	-10000
		2's comp HEX	7FFF	8000
05	-2.5 ~ +2.5 V	Engineering Unit	+25000	-25000
		2's comp HEX	7FFF	8000
06	-20 ~ +20 mA	Engineering Unit	+20000	-20000
		2's comp HEX	7FFF	8000
07	+4 ~ +20 mA	Engineering Unit	+20000	+4000
		2's comp HEX	FFFF	0000
08	-10 ~ +10 V	Engineering Unit	+10000	-10000
		2's comp HEX	7FFF	8000
09	-5 ~ +5 V	Engineering Unit	+5000	-5000
		2's comp HEX	7FFF	8000

Type Code	Input Range	Data Format	+F.S	-F.S
0A	-1 ~ +1 V	Engineering Unit	+10000	-10000
		2's comp HEX	7FFF	8000
0B	-500 ~ +500 mV	Engineering Unit	+5000	-5000
		2's comp HEX	7FFF	8000
0C	-150 ~ +150 mV	Engineering Unit	+15000	-15000
		2's comp HEX	7FFF	8000
0D	-20 ~ +20 mA	Engineering Unit	+20000	-20000
		2's comp HEX	7FFF	8000
1A	0 ~ +20 mA	Engineering Unit	+20000	0
		2's comp HEX	FFFF	0000
0E	Type J Thermocouple -210 ~ 760°C	Engineering Unit	+7600	-2100
		2's comp HEX	7FFF	DCA2
0F	Type K Thermocouple -270 ~ 1372°C	Engineering Unit	+13720	-2700
		2's comp HEX	7FFF	E6D0
10	Type T Thermocouple -270 ~ 400°C	Engineering Unit	+4000	-2700
		2's comp HEX	7FFF	A99A
11	Type E Thermocouple -270 ~ 1000°C	Engineering Unit	10000	-2700
		2's comp HEX	7FFF	DD71
12	Type R Thermocouple 0 ~ 1768°C	Engineering Unit	+17680	0
		2's comp HEX	7FFF	0000
13	Type S Thermocouple 0 ~ 1768°C	Engineering Unit	+17680	0
		2's comp HEX	7FFF	0000

Type Code	Input Range	Data Format	+F.S	-F.S
14	Type B Thermocouple 0 ~ 1820°C	Engineering Unit	+18200	0
		2's comp HEX	7FFF	0000
15	Type N Thermocouple -270 ~ 1300°C	Engineering Unit	+13000	-2700
		2's comp HEX	7FFF	E56B
16	Type C Thermocouple 0 ~ 2320°C	Engineering Unit	+23200	0
		2's comp HEX	7FFF	0000
17	Type L Thermocouple -200 ~ 800°C	Engineering Unit	+8000	-2000
		2's comp HEX	7FFF	E000
18	Type M Thermocouple -200 ~ 100°C	Engineering Unit	+10000	-20000
		2's comp HEX	4000	8000
19	Type L DIN43710 Thermocouple -200 ~ 900°C	Engineering Unit	9000	-2000
		2's comp HEX	FFFF	E38E
20	Platinum 100 $\alpha=0.00385$ -100 ~ 100°C	Engineering Unit	+10000	-10000
		2's comp HEX	7FFF	8000
21	Platinum 100 $\alpha=0.00385$ 0 ~ 100°C	Engineering Unit	+10000	0
		2's comp HEX	7FFF	0000
22	Platinum 100 $\alpha=0.00385$ 0 ~ 200°C	Engineering Unit	+20000	0
		2's comp HEX	7FFF	0000
23	Platinum 100 $\alpha=0.00385$ 0 ~ 600°C	Engineering Unit	+6000	0
		2's comp HEX	7FFF	0000

Type Code	Input Range	Data Format	+F.S	-F.S
24	Platinum 100 $\alpha=0.003916$ -100 ~ 100°C	Engineering Unit	+10000	-10000
		2's comp HEX	7FFF	8000
25	Platinum 100 $\alpha=0.003916$ 0 ~ 100°C	Engineering Unit	+10000	0
		2's comp HEX	7FFF	0000
26	Platinum 100 $\alpha=0.003916$ 0 ~ 200°C	Engineering Unit	+20000	0
		2's comp HEX	7FFF	0000
27	Platinum 100 $\alpha=0.003916$ 0 ~ 600°C	Engineering Unit	+6000	0
		2's comp HEX	7FFF	0000
28	Nickel 120 -80 ~ 100°C	Engineering Unit	+10000	-8000
		2's comp HEX	7FFF	999A
29	Nickel 120 0 ~ 100°C	Engineering Unit	+10000	0
		2's comp HEX	7FFF	0000
2A	Platinum 1000 $\alpha=0.00385$ -200 ~ 600°C	Engineering Unit	+6000	-2000
		2's comp HEX	7FFF	D556
2B	Cu 100 $\alpha=0.00421$ -20 ~ 150°C	Engineering Unit	+15000	-2000
		2's comp HEX	7FFF	EEEE
2C	Cu 100 $\alpha=0.00427$ 0 ~ 200°C	Engineering Unit	+20000	0
		2's comp HEX	7FFF	0000
2D	Cu 1000 $\alpha=0.00421$ -20 ~ 150°C	Engineering Unit	+15000	-2000
		2's comp HEX	7FFF	EEEE

Type Code	Input Range	Data Format	+F.S	-F.S
2E	Platinum 1000 $\alpha=0.00385$ -200 ~ 200°C	Engineering Unit	+20000	-20000
		2's comp HEX	7FFF	8000
2F	Platinum 1000 $\alpha=0.003916$ -200 ~ 200°C	Engineering Unit	+20000	-20000
		2's comp HEX	7FFF	8000
80	Platinum 100 $\alpha=0.00385$ -200 ~ 600°C	Engineering Unit	+6000	-2000
		2's comp HEX	7FFF	D556
81	Platinum 100 $\alpha=0.003916$ -200 ~ 600°C	Engineering Unit	+6000	-2000
		2's comp HEX	7FFF	D556
82	Cu 50 -50 ~ 150°C	Engineering Unit	+15000	-5000
		2's comp HEX	7FFF	D556
83	Nickel 100 -60 ~ 180°C	Engineering Unit	+18000	-6000
		2's comp HEX	7FFF	D556



## Appendix E. Analog Output Type and Data Format Table

Type Code	Input Range	Data Format	+F.S	-F.S
30	0 ~ +20 mV	Engineering Unit	+20000	0
		2's comp HEX	FFFF	0000
31	4 ~ +20 mV	Engineering Unit	+20000	4000
		2's comp HEX	FFFF	0000
32	0 ~ +10 V	Engineering Unit	+10000	0
		2's comp HEX	7FFF	0000
33	-10 ~ +10 V	Engineering Unit	+10000	-10000
		2's comp HEX	7FFF	8000
34	0 ~ +5 V	Engineering Unit	+5000	0
		2's comp HEX	7FFF	0000
35	-5 ~ +5 V	Engineering Unit	+5000	-5000
		2's comp HEX	7FFF	8000

# Appendix F. Network Address Translation

For a computer to communicate with ET-7X00/PET-7X00 modules on the Internet, ET-7X00/PET-7X00 modules must have a public IP address. Basically, it works like your street address - as a way to find out exactly where you are and deliver information to you.

Network Address Translation (NAT) allows a single device, such as a router, to act as an agent between the Internet (or "public network") and a local (or "private") network. This means that only a single, unique IP address is required to represent an entire group of computers.

A type of NAT in which a private IP address is mapped to a public IP address, where the public address is always the same IP address (i.e., it has a static address). This allows an internal host, such as an ET-7X00/PET-7X00 module, to have an unregistered (private) IP address and still be reachable over the Internet.

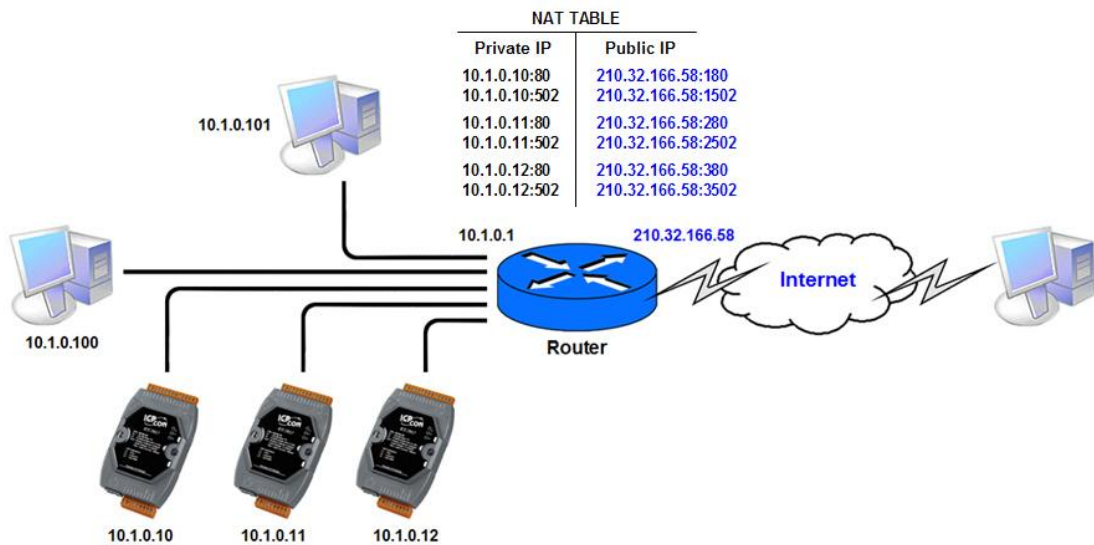

## Step 1 : Configure the Ethernet settings of ET-7X00/PET-7X00 module.

The Gateway must be set to the IP address of router (i.e., 10.1.0.1)

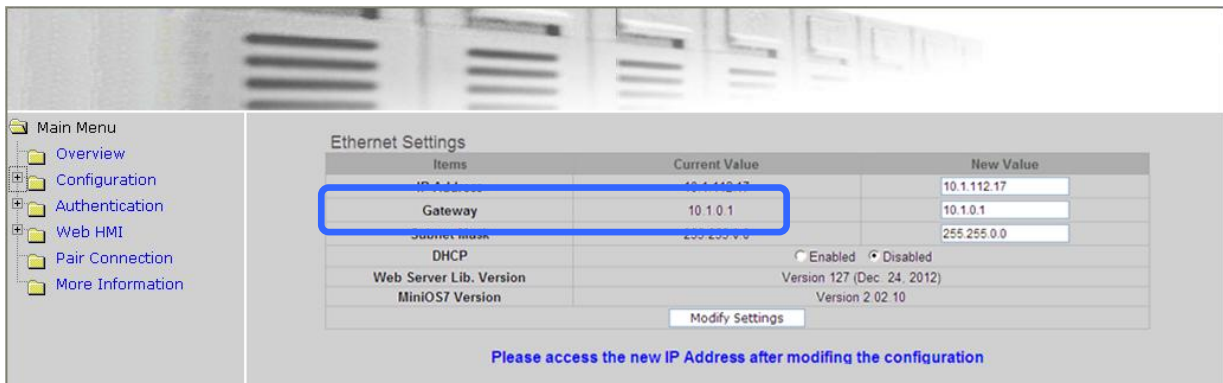

## Step 2 : Connect to the web server of ET-7X00/PET-7X00 module with the public IP address on the Internet

For accessing the web page, the access URL will need to include the port number as shown below: <http://210.32.166.58:180>

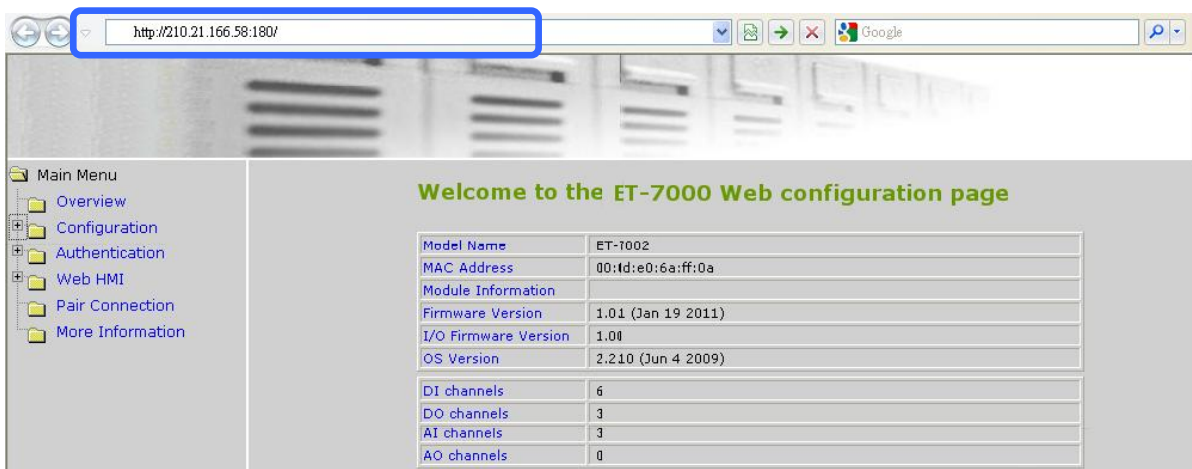

# Appendix G. Troubleshooting

A number of common problems are easy to diagnose and fix if you know the cause.

Symptom/Problem	Possible cause	Solution
The Run LED doesn't light	Internal power has failed	Return the module for repair.
The Run LED indicator is ON (light), but not flashing.	The module has possibly crashed.	Reboot the module
Cannot communicate via the Ethernet port, but the ET-7X00/PET-7X00 is still operating.	The IP/Mask/Gateway address isn't within the IP address range of the LAN.	Change the IP/Mask/Gateway address to match the LAN, or ask the MIS administrator for assistance.
	The IP address has restricted by the IP filter settings	Check the IP filter setting using the Web configuration.
	There are more than 30 TCP/IP connections.	Reboot the module.
Able to explore the web page through Port 80 using a web browser, but the Web HMI and Modbus/TCP program cannot access the module through Port 502.	Port 502 has been restricted by the firewall.	Consult your MIS administrator for assistance.
The Web HMI and Modbus/TCP program can access the module through Port 502, but Web browser cannot explore the web page through Port 80 using a web browser.	The Port 80 has restricted by the firewall.	Consult your MIS administrator for assistance.
	The Web server TCP Port has been changed from Port 80 (Shown on the Basic Settings page)	Change the TCP Port to 80 or reconnect the ET-7X00/PET-7X00 using the specific TCP Port.

# Appendix H. Revision History

The table below shows the revision history.

Revision	Date	Description
1.0.1	December 2011	Initial issue
1.1.0	February 2013	<ol style="list-style-type: none"><li>1. Added the I/O configuration instructions in section 2.7. Configuring the I/O Functions.</li><li>2. Added the revision history in appendix H. Revision History</li></ol>
1.1.1	April 2013	Added the tip about selecting the input/output range of each analog input/output channel in section 3.2.3.(D) Analog Output Settings and 3.2.3.(E) Analog Input Settings.
1.1.2	February 2014	Added product information for the ET-7200/PET-7200 in each section of the manual.