



Industrial Computer Products

Data Acquisition Systems

MQ-7200M Series

User Manual



Version 1.0.0, Aug. 2016

Written by Liam Lin
Edited by Sunny Chiu

Warranty

All products manufactured by ICP DAS are under warranty regarding defective materials for a period of one year, beginning from the date of delivery to the original purchaser.

Warning

ICP DAS assumes no liability for any damage resulting from the use of this product. ICP DAS reserves the right to change this manual at any time without notice. The information furnished by ICP DAS is believed to be accurate and reliable. However, no responsibility is assumed by ICP DAS for its use, nor for any infringements of patents or other rights of third parties resulting from its use.

Copyright

Copyright © 2016 by ICP DAS CO., LTD. All rights are reserved.

Trademarks

Names are used for identification purpose only and may be registered trademarks of their respective companies.

Contact US

If you have any problems, please feel free to contact us.

You can count on us for a quick response.

Email: service@icpdas.com

Table of Contents

1. Introduction	1
1.1. Features	2
1.2. Overview	5
1.3. Dimensions (Unit: mm)	6
2. Hardware Information	7
2.1. MQ-7244M	7
2.2. MQ-7251M	9
2.3. MQ-7252M	10
2.4. MQ-7253M	12
2.5. MQ-7255M	13
3. Getting Started	15
3.1. Cabling Power and Network	16
3.2. Installing the MiniOS7 Utility	17
3.3. Configuring Network Settings	17
3.4. Enabling the Adobe Flash Player in Your Browser	21
3.5. Logging in to Web Interface	22
4. Configuration	24
4.1. Basic Settings	25
4.2. I/O Settings	28
4.3. MQTT	30
5. Web HMI	38
6. MiniOS7 Utility Tools	41
6.1. Establishing a Connection	41
6.2. Exchanging the Protocol (TCP/IP to UDP)	44
6.3. Updating the MQ-7200M OS	46

6.4. Updating the MQ-7200M Firmware	49
7. FAQ	52
7.1. How to publish I/O status message to an MQTT broker?.....	52
7.2. How to subscribe I/O status on a MQ-7200M?.....	54
7.3. How to control DO channel on a MQ-7200M?.....	56
7.4. How to restore MQ-7200M to default settings?	58
Troubleshooting	59
Revision History	60

1. Introduction

The MQ-7200M series is a web-based Ethernet I/O module equipped with a built-in web server allows the user to configure module and control/monitor the status of digital I/O by simply using a regular web browser.

Support for MQTT protocol makes it easy to connect sensors to Internet of Things (IoT) system via the MQ-7200M series module. Users can simply and effectively control/monitor remote sensors with MQTT client tools on the PC/NB or mobile devices.

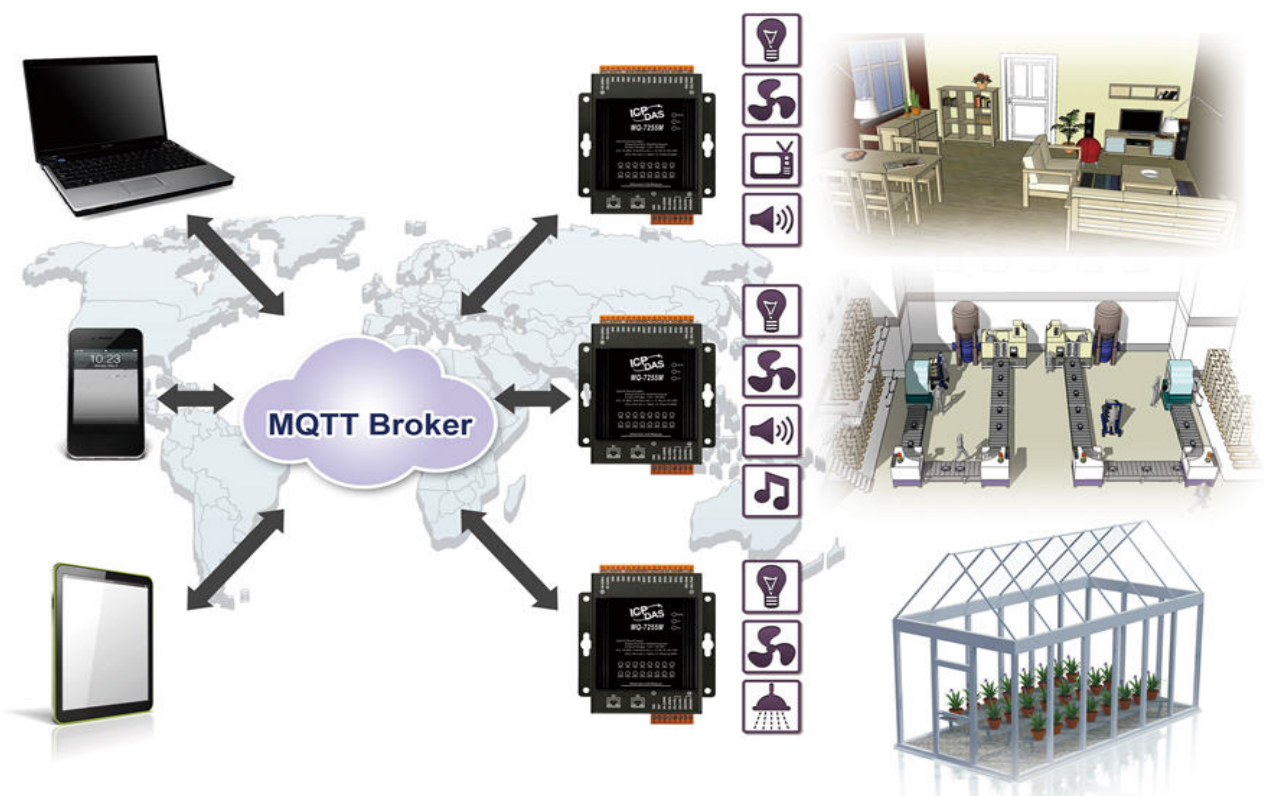

1.1. Features

The MQ-7200M module offers the most comprehensive configuration focused on meeting specific application requirements. The following details the features designed to simplify installation, configuration and application.

Support for MQTT Protocol

MQTT stands for Message Queuing Telemetry Transport. It is a machine-to-machine (M2M)/"Internet of Things" connectivity protocol with extremely lightweight publish/subscribe messaging transport. It is useful for mobile applications because of its small size, low power usage, minimized data packets, and efficient distribution of information to one or many receivers.

Built-in I/O

Various I/O components are mixed with multiple channels in a single I/O module, which provides the most cost effective I/O usage and enhances performance of the I/O operations.

Daisy-Chain Ethernet Cabling

The MQ-7200M Series has a built-in two-port Ethernet switch to implement daisy-chain topology. The cabling is much easier and total costs of cable and switch are significantly reduced.



LAN Bypass

LAN Bypass feature guarantees the Ethernet communication. It will automatically active to continue the network traffic if any one of the MQ-7200M loses its power.

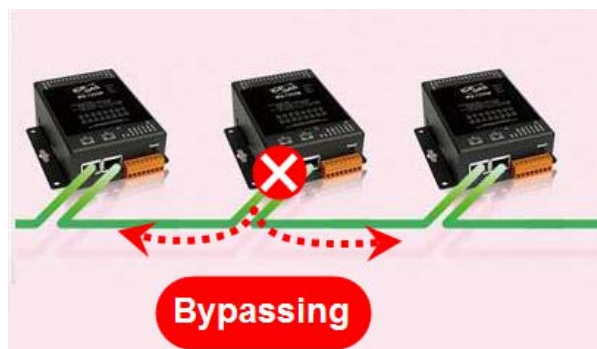

Dual Watchdog

The Dual Watchdog is consists of a Module Watchdog and a Communication Watchdog. The actions of digital output are also associated to the Dual Watchdog.

Module Watchdog is a built-in hardware circuit to monitor the operation of the module and will reset the CPU if a failure occurs in the hardware or the software. Then the Power-on Value of digital output will be loaded.

Communication Watchdog is a software function to monitor the communication between the MQTT broker and the MQ-7200M. When the MQ-7200M is disconnected from the MQTT broker for a while, the watchdog forces the digital output to pre-defined Safe Value to prevent unpredictable damage of the connected devices.

Power-on Value and Safe Value

Power-on value and Safe Value are designed to improve system safety:

Power-on Value: The Power-on Value is loaded into the digital output when the module is powered-on or reset by Module Watchdog.

Safe Value: When the Communication Watchdog is enabled and a Communication Watchdog timeout occurs, the “safe value” is loaded into the digital output.

Highly Reliable Under Harsh Environment

Wide Operating Temperature Range: -25 ~ +75°C

Storage Temperature: -30 ~ +80°C

Humidity 10 ~ 90% RH (Non-condensing)



Reset Button

The reset button is used to restore all settings to factory defaults.

It is very useful especially when you forget the IP address to access the MQ-7200M module.

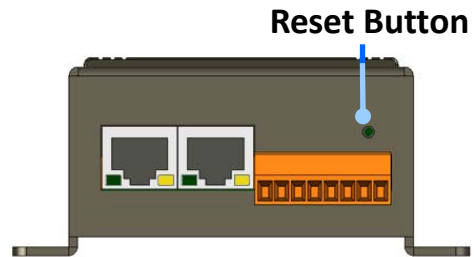

Pressing and holding the reset button for at least 3 seconds will restore the module to its factory defaults. For more information, see section "7.4. How to restore MQ-7200M to default settings?".

LED indicators for DIO status

The LED indicators are used to indicate the status of digital I/O on the MQ-7200M.

Two pair of power input pins

The MQ-7200M has 4 pins as two pairs for power input to ease the wiring.

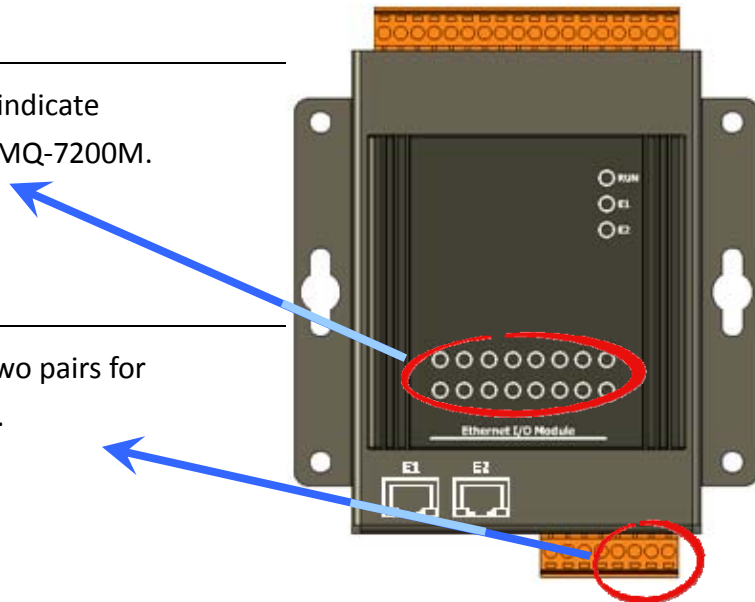

1.2. Overview

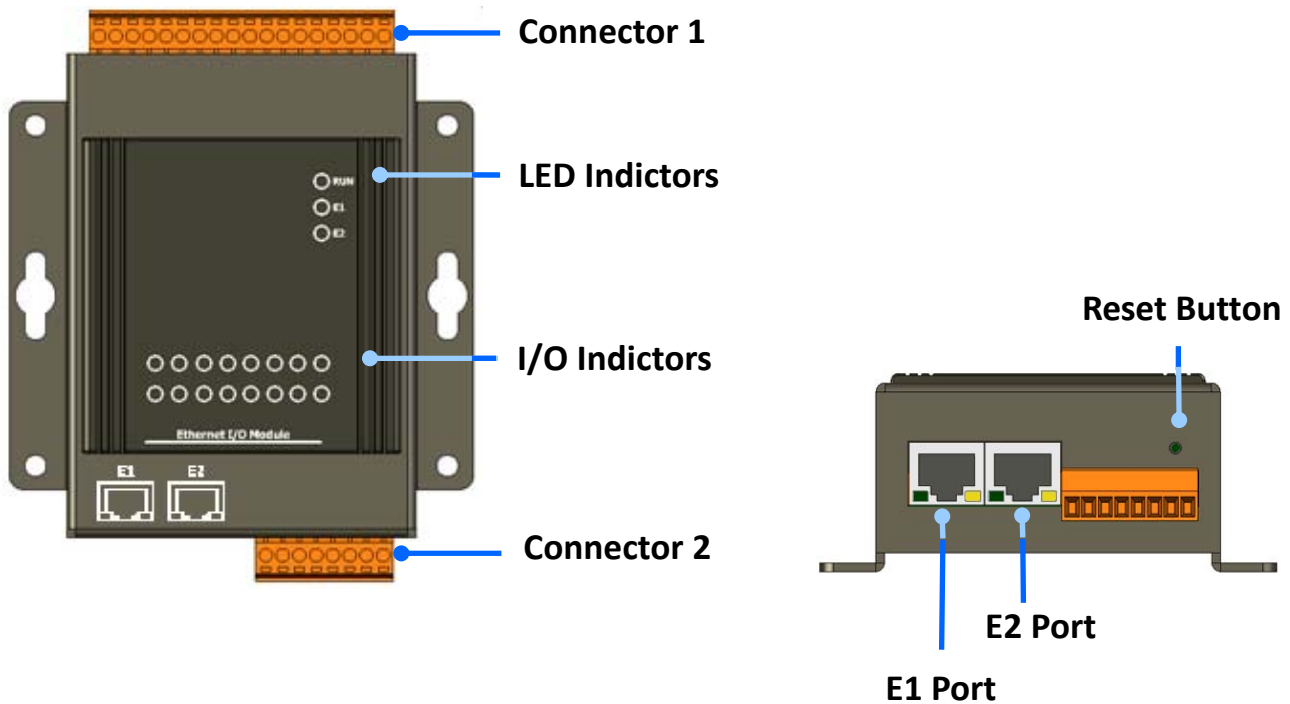

Model	Label	Status	Description
LED Indicators	RUN	Flashing	The unit is turned on and ready.
	E1	On	A link has been established on the E1 port.
		Off	No link is established on the E1 port.
		Flashing	Data is transferring via the E1 port.
	E2	On	A link has been established on the E2 port.
		Off	No link is established on the E2 port.
		Flashing	Data is transferring via the E2 port.
	I/O Indicators	The exact design and functionality depends on the I/O types on the module.	
Connector 1		The exact design and functionality depends on the module specifications.	
Connector 2			
Reset Button		Pressing and holding the reset button for at least 3 seconds can reset the module.	

1.3. Dimensions (Unit: mm)

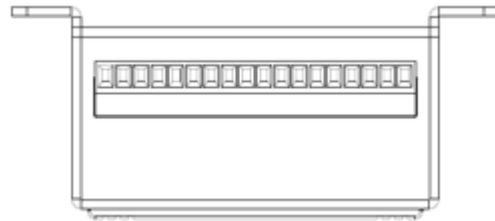

Top View



Left Side View

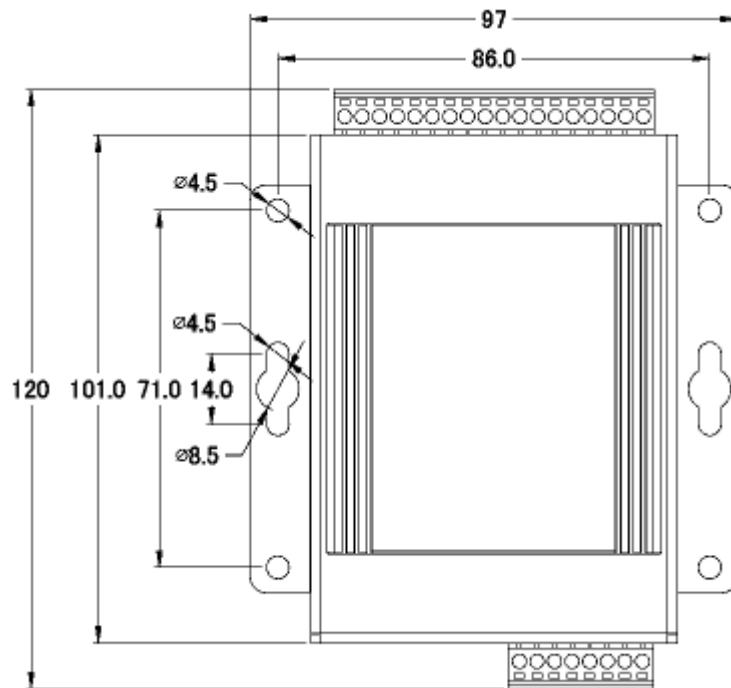

Front View

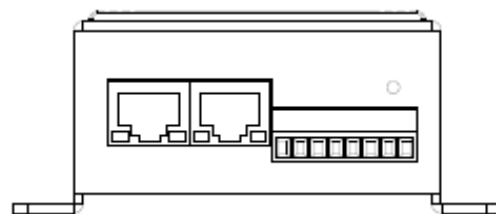

Bottom View

2. Hardware Information

2.1. MQ-7244M

I/O Specifications

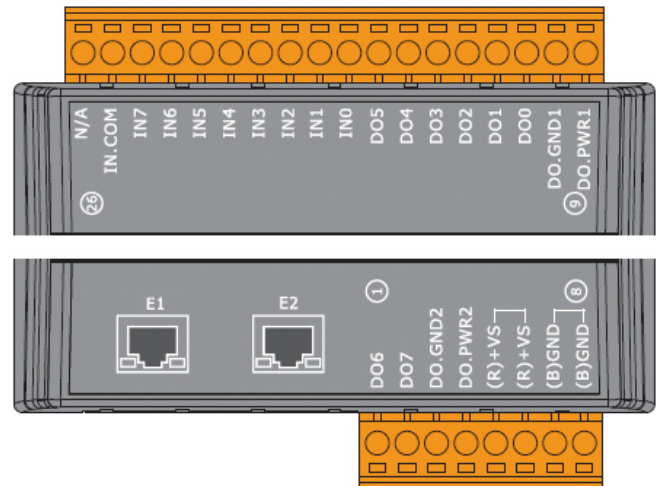

Digital Input	
Channels	8
Contact	Wet Contact
Sink/Source (NPN/PNP)	Sink/Source
On Voltage Level	+10 V _{DC} ~ +50V _{DC}
Off Voltage Level	+4 V _{DC} max.
Input Impedance	10 KΩ
Overvoltage Protection	70 V _{DC}
Digital Output	
Channels	8
Type	Isolated Open Collector
Sink/Source (NPN/PNP)	Sink
Max. Load Current	650 mA/Channel at 25°C Direct Drive Power Relay Module
Load Voltage	+3.5 V _{DC} ~ +50 V _{DC}
Overvoltage Protection	60 V _{DC}
Overload Protection	1.4 A
Short-circuit Protection	Yes
Power-on Value	Yes, Configurable
Safe Value	Yes, Configurable

Pin Assignments

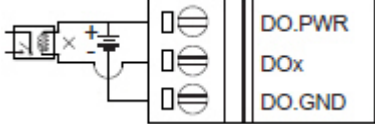

Wire Connections

Digital Input	Readback as 1	Readback as 0
Sink	+10 ~ +50 V _{DC} 	Open or <4 V _{DC}
	+10 ~ +50 V _{DC} 	Open or <4 V _{DC}

Digital Output	ON State Readback as 1	OFF State Readback as 0
Drive Relay		
Resistance Load		

2.2. MQ-7251M

I/O Specifications

Digital Input	
Channels	16
Contact	Wet Contact
Sink/Source (NPN/PNP)	Sink/Source
On Voltage Level	+10 V _{DC} ~ +50V _{DC}
Off Voltage Level	+4 V _{DC} max.
Input Impedance	10 K Ω
Overvoltage Protection	70 V _D

Pin Assignments

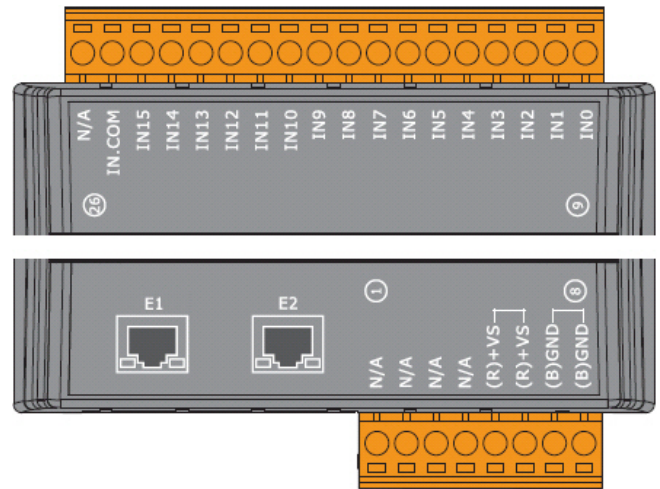

Wire Connections

Digital Input	Readback as 1	Readback as 0
Sink	+10 ~ +50 V _{DC} 	Open or <4 V _{DC}
	Source	+10 ~ +50 V _{DC}

2.3. MQ-7252M

I/O Specifications

Digital Input	
Channels	8
Contact	Wet Contact
Sink/Source (NPN/PNP)	Sink/Source
On Voltage Level	+10 V _{DC} ~ +50V _{DC}
Off Voltage Level	+4 V _{DC} max.
Input Impedance	10 KΩ
Overvoltage Protection	70 V _{DC}
Digital Output	
Channels	8
Type	Isolated Open Collector
Sink/Source (NPN/PNP)	Source
Max. Load Current	650 mA/Channel at 25°C
Load Voltage	+10 V _{DC} ~ +40 V _{DC}
Overvoltage Protection	47 V _{DC}
Overload Protection	-
Short-circuit Protection	Yes
Power-on Value	Yes, Configurable
Safe Value	Yes, Configurable

Pin Assignments

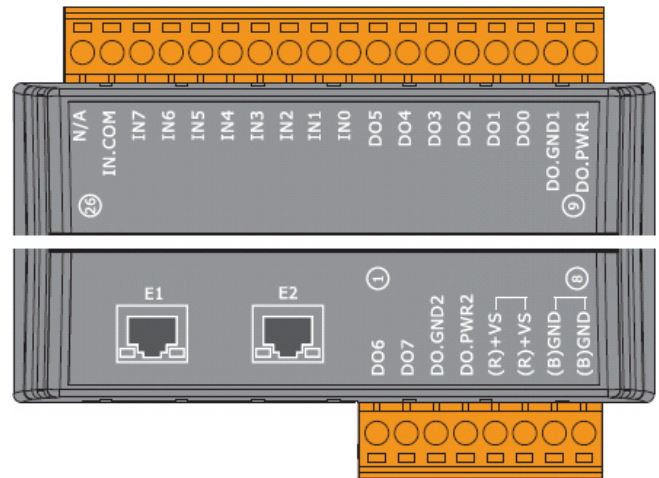

Wire Connections

Digital Input	Readback as 1	Readback as 0
Sink	+10 ~ +50 V _{DC}	Open or <4 V _{DC}
Source	+10 ~ +50 V _{DC}	Open or <4 V _{DC}

Digital Output	ON State Readback as 1
Source	
	OFF State Readback as 0

2.4. MQ-7253M

I/O Specifications

Digital Input	
Channels	16
Contact	Dry Contact
Sink/Source (NPN/PNP)	Source
On Voltage Level	Close to GND
Off Voltage Level	Open
Overvoltage Protection	-
Effective Distance	500 M Max.

Pin Assignments

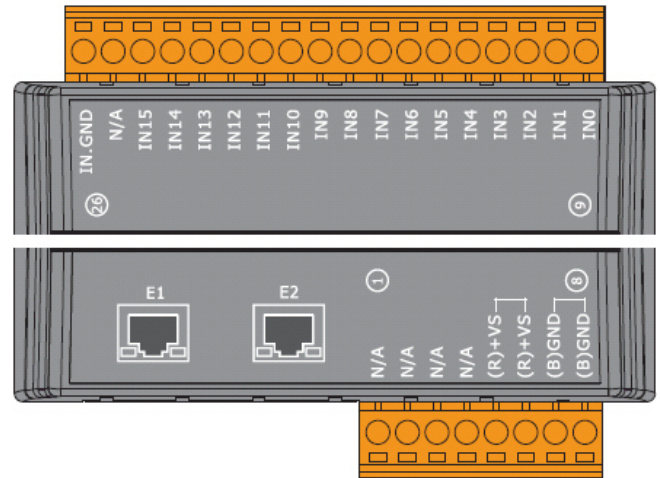

Wire Connections

Digital Input	ON State Readback as 1
Dry Contact	
	OFF State Readback as 0

2.5. MQ-7255M

I/O Specifications

Digital Input		
Channels	8	
Contact	Dry and Wet Contact	
Sink/Source (NPN/PNP)	Dry: Source Wet: Sink/Source	
Wet Contact	On Voltage Level	+10 V _{DC} ~ +50 V _{DC}
	Off Voltage Level	+4 V _{DC} max.
Dry Contact	On Voltage Level	Close to GND
	Off Voltage Level	Open
Input Impedance	10 K Ω	
Overvoltage Protection	+70 V _{DC}	
Digital Output		
Channels	8	
Type	Isolated Open Collector	
Sink/Source (NPN/PNP)	Source	
Max. Load Current	650 mA/channel at 25°C	
Load Voltage	+10 V _{DC} ~ +40 V _{DC}	
Overvoltage Protection	47 V _{DC}	
Overload Protection	-	
Short-circuit Protection	Yes	
Power-on Value	Yes, Configurable	
Safe Value	Yes, Configurable	

Pin Assignments

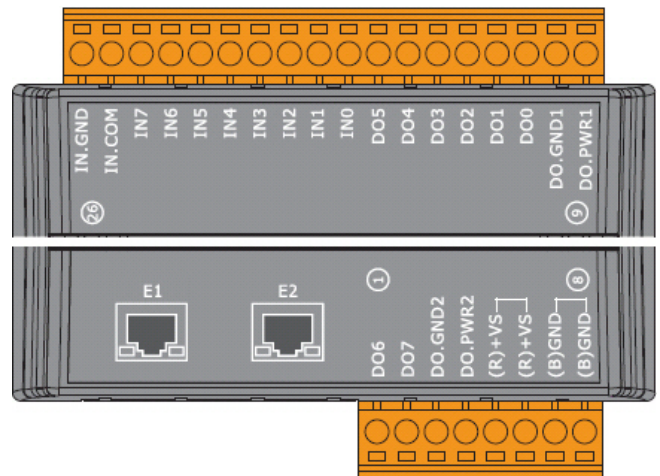

Wire Connections

Digital Input	Readback as 1	Readback as 0
Wet Contact (Sink)	+10 ~ +50 V _{DC} 	Open or <4 V _{DC}
	Wet Contact (Source)	+10 ~ +50 V _{DC}

Digital Input	ON State Readback as 1	OFF State Readback as 0
Dry Contact		

Digital Output	ON State Readback as 1
Source	
	OFF State Readback as 0

3. Getting Started

If you are new to MQ-7200M module, start with this chapter as it includes a guided tour that provides a basic overview of how to install, configure and use the module.

What’s in the BOX?

Before starting any task, please check the package contents. If any of the following items are either missing or damaged, contact your dealer or distributor.



MQ-7200M Module

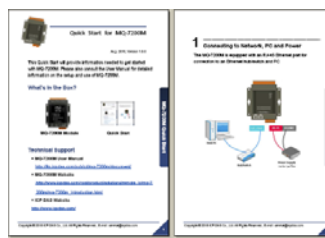

Quick Start Guide

Technical Support

- MQ-7200M User Manual
<http://ftp.icpdas.com/pub/cd/mq-7200m/document>
- MQ-7200M Website
http://www.icpdas.com/root/product/solutions/remote_io/mqtt_io/mq-7200m_introduction.html
- ICP DAS Website
<http://www.icpdas.com/>

3.1. Cabling Power and Network

Step 1 :

Connect the computer to the Ethernet Port via the Hub or Switch.

Step 2 :

Connect the positive of the power supply to the terminal marked “(R)+Vs”.

Connect the negative of the power supply to the terminal marked “(B)GND”.

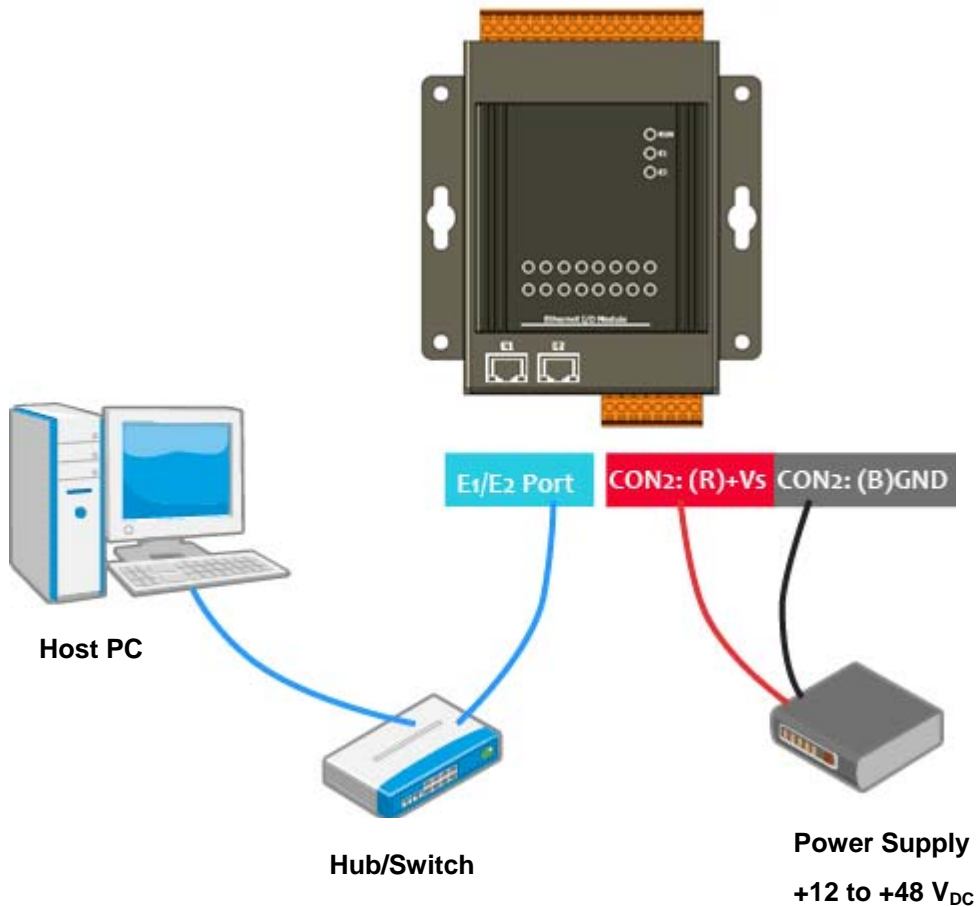

3.2. Installing the MiniOS7 Utility

The MiniOS7 Utility provides a quick and easy way to configure the Ethernet settings, update OS image or firmware file to the MQ-7200M from a computer. After the installation has been completed, a new short cut for the MiniOS7 Utility will be displayed on your desktop.

Download the MiniOS7 Utility from the ICP DAS FTP site and install it:

<http://www.icpdas.com/download/minios7.htm>

3.3. Configuring Network Settings

The MQ-7200M comes with default network settings as the table below. Before starting the MQ-7200M, valid network settings for the LAN where the module will operate need be set to the module.

Default Ethernet Settings

Item	Default
IP Address	192.168.255.1
Subnet Mask	255.255.0.0
Gateway	192.168.0.1

Step 1 : Run the MiniOS7 Utility

Double-click the “MiniOS7 Utility” shortcut on your desktop.

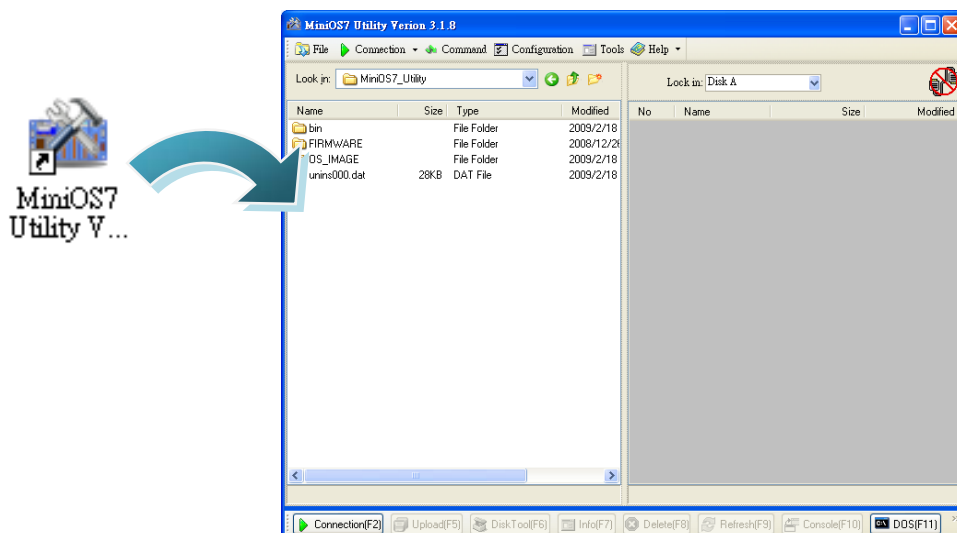

Step 2 : Search the MQ-7200M module on the LAN

Press the “F12” key, or click “Search” on the “Connection” menu, the utility will search all modules with MiniOS7 OS on your network.

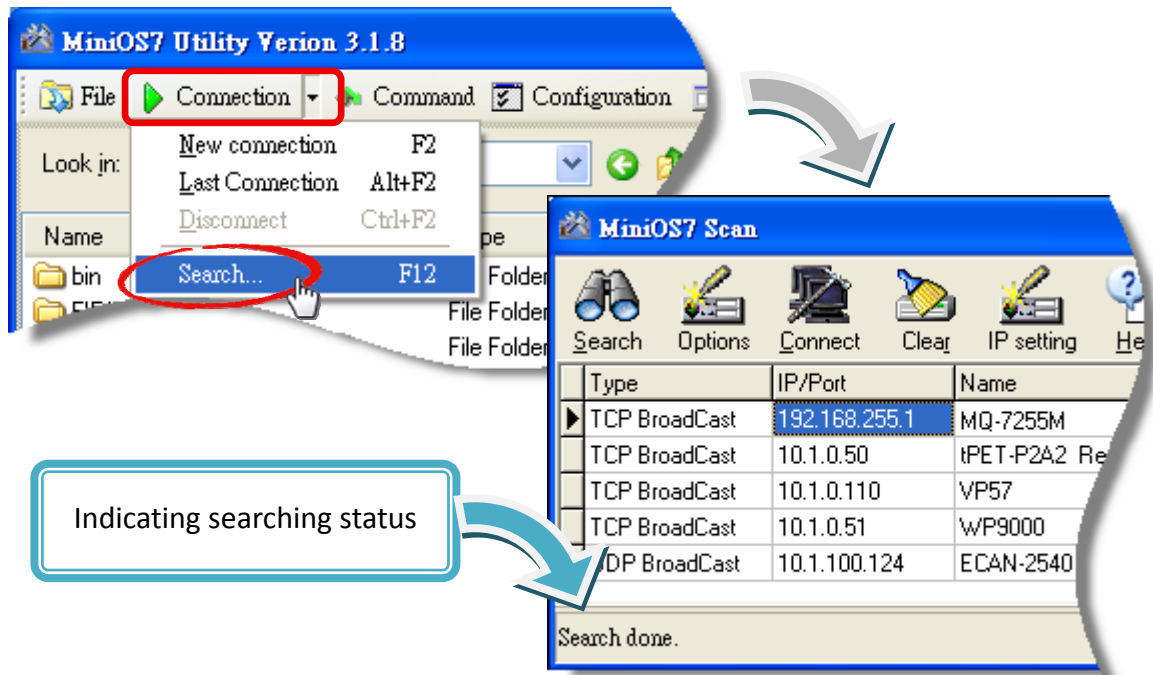

Step 3 : Open the IP Setting dialog box

After the search has been completed, click the item with a default IP address of **192.168.255.1** in the IP/Port field list, and then click on the **IP setting** icon on the toolbar to open the IP Settings dialog box.

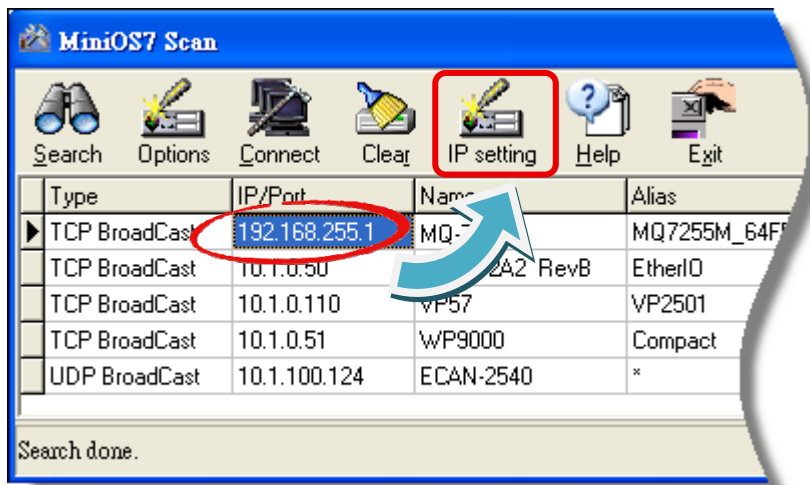

Step 4 : Assign appropriate IP/Mask/Gateway addresses

In the **IP Setting** dialog box, you can manually assign an IP address, Mask address, Gateway and Alias, or enable the DHCP client function to obtain an IP address from the DHCP server.

Once the appropriate values have been entered, click on the **“Set”** button to update the settings.

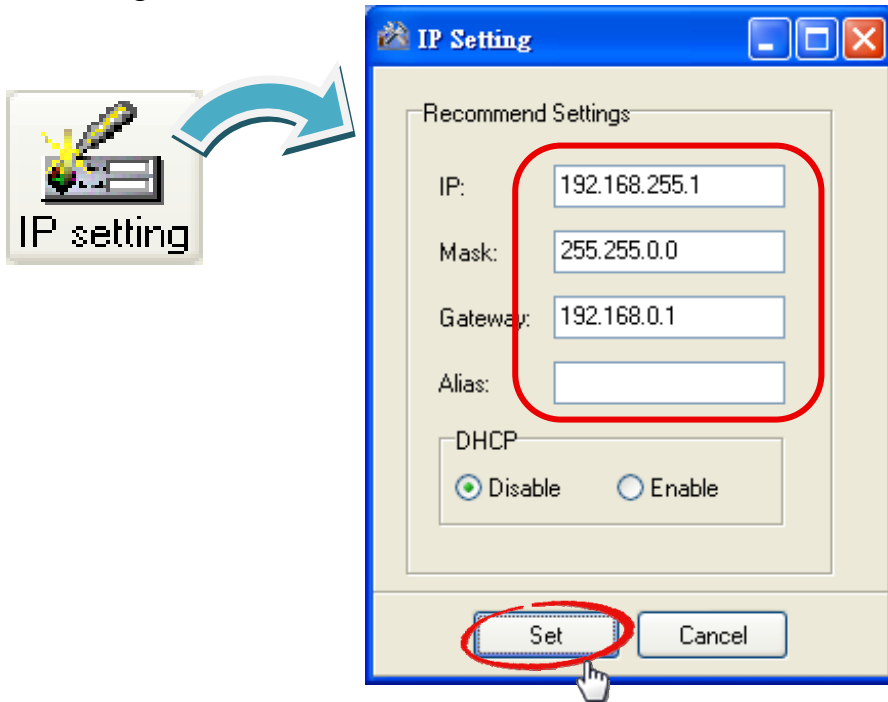

Step 5 : Verify your new settings

Reboot the module and then repeat step 2, press the “F12” to search the module again and make sure the new settings are effective.

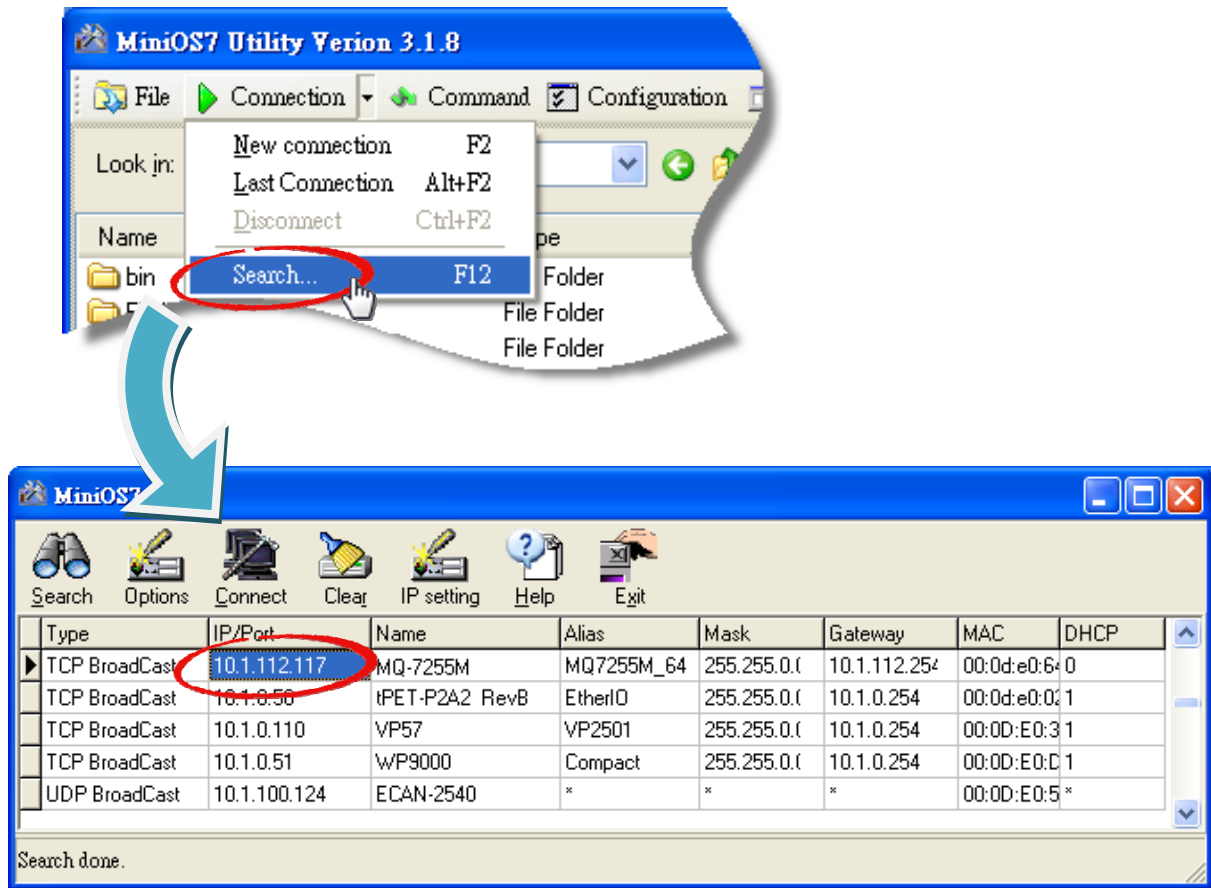

3.4. Enabling the Adobe Flash Player in Your Browser

The MQ-7200M Web HMI page requires the Adobe Flash Player to be installed in your browser. The latest version of the Adobe Flash Player can be downloaded by accessing the Adobe Systems Incorporated website. The following instructions will help you to install the Adobe Flash Player in your web browser.

Step 1 : Go to the Adobe Flash Player Download Center



The Adobe Flash Player Download Center:

<http://get.adobe.com/flashplayer/>

The Adobe Flash Player is subject to change without notice; refer to <http://www.adobe.com/support/flashplayer/downloads.html> for the latest version of this software.

Step 2 : Follow the instructions to download the installation file

Click the “Agree and install now” button and follow the instructions to download the installation file. Note that unless you uncheck the option, the Google Toolbar will be included in the installation by default, so if you do not require this feature, be sure to uncheck this option.

A screenshot of the Adobe Flash Player download page. The page features the Adobe Flash logo on the left. The main content area is titled "Install Adobe Flash Player" and shows the version "10.0.32.18" for "Windows, Internet Explorer" with a size of "1.87 MB". Below this, there are links for "Learn more", "System requirements", "Distribute Flash Player", and "Installation instructions". A section titled "Also install:" shows a checked box for "Free Google Toolbar (optional)" with a size of "1.8 MB". Below this is a small image of the Google Toolbar. At the bottom, there is a yellow button with a downward arrow and the text "Agree and install now", which is circled in green. To the right of the button, the total size is listed as "Total: 3.67MB".

3.5. Logging in to Web Interface

The MQ-7200M series contains a web-based user interface for users to manage the module, access I/O lines and monitor the running status via a standard web browser.

Step 1 : Launch your browser

You can use a standard internet browser to log in to the MQ-7200M module, such as Mozilla Firefox or Internet Explorer, etc.

Step 2 : Enter the IP address for the MQ-7200M

If you haven't changed the default IP address of the MQ-7200M module, refer to section 3.2. and 3.3. to configure it.



Step 3 : Enter your User name and Password

The factory default user name and password are as follows:

Item	Default
User name	Admin
Password	Admin

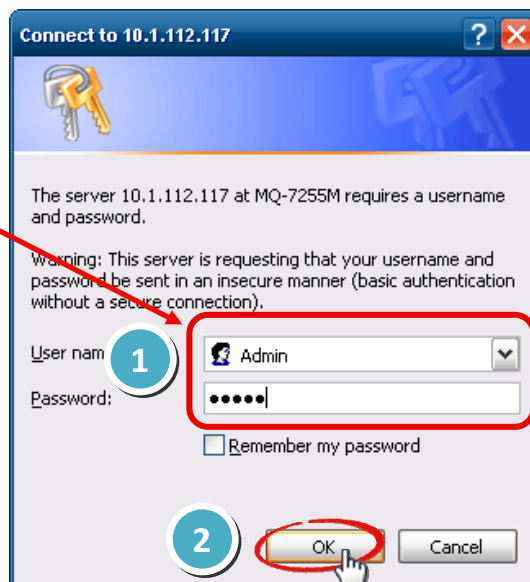

Step 4 : Welcome to the MQ-7200M web interface

After logging in to the module, the first page is overview information about MAC address and version number of the firmware running on the module.

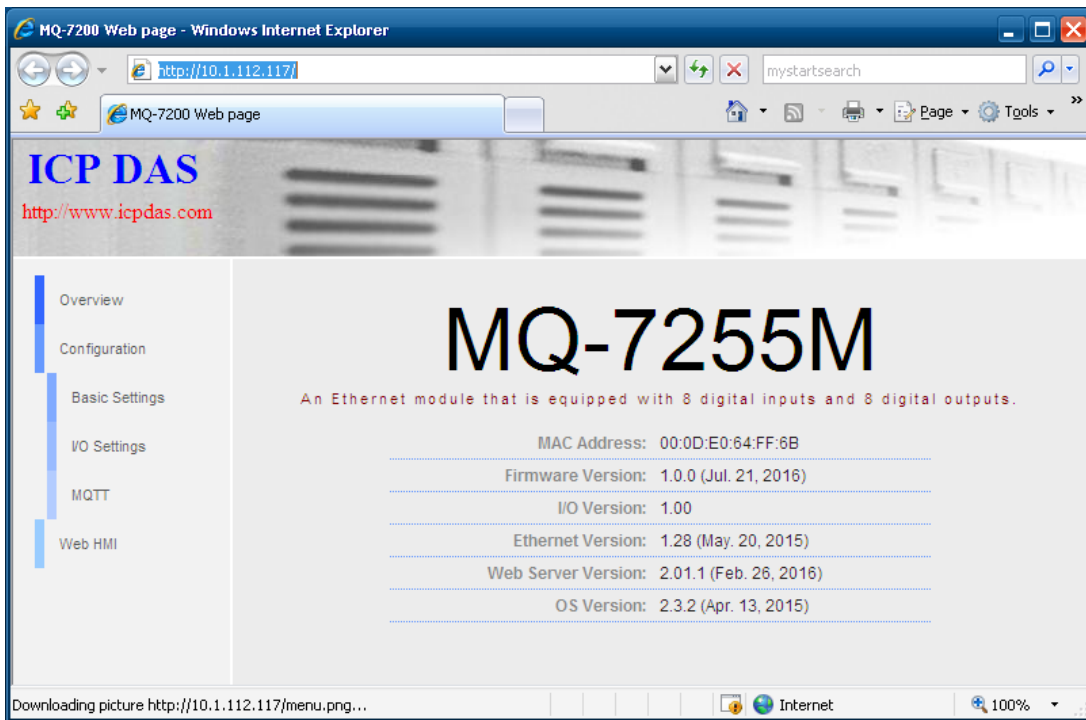

4. Configuration

The web-based user interface allows users to configure the module, access I/O lines and monitor the module status via a standard web browser.

Before beginning the configuration process, refer to **Sec.3. Getting Started** to log in to the MQ-7200M module.

Step 1 : Welcome to the MQ-7200M web interface

After logging into the MQ-7200M web interface, the first page you will encounter is called “Overview”, and shows the MAC address and version number of the firmware running on the module.

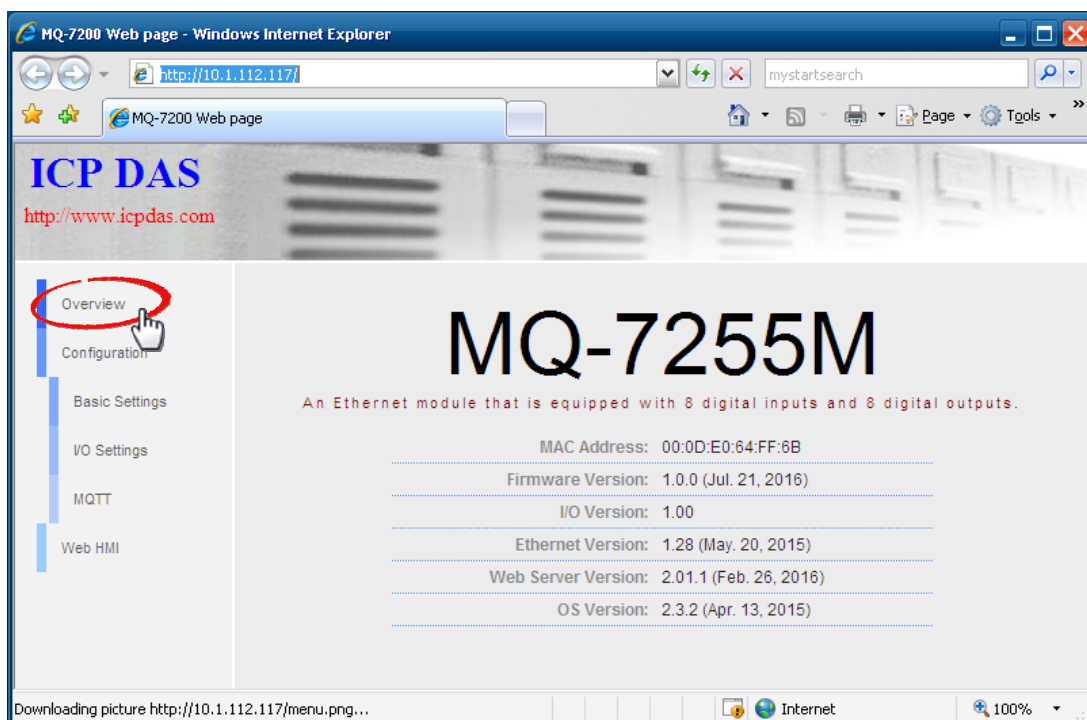

4.1. Basic Settings

The basic settings page includes **Network Configuration** and **Web Configuration** sections.

ICP DAS
http://www.icpdas.com

Overview
Configuration
Basic Settings
I/O Settings
MQTT
Web HMI

Network Configuration

IP Address

Subnet Mask

Gateway

DNS Server

DHCP Enabled Disabled

Web Configuration

Module Name

Page Header Information (First line)

Color Font Size

Page Header Information (Second line)

Color Font Size

Web Server Port

A Network Configuration

In general, network settings include the following parameters:

- **An IP address:** Each MQ-7200M on the network must have a unique IP address.
- **A default gateway:** A gateway (or router) is a system that is used to connect a network with one or more other networks.
- **A subnet mask:** The subnet mask indicates which portion of the IP address that is used to identify the local network or subnet.

There are two methods of configuring the network settings:

- **Dynamic configuration:** The Dynamic Host Configuration Protocol (DHCP) is a network application protocol that automatically assigns an IP address to a device.
- **Manual configuration:** In the absence of DHCP, MQ-7200M modules can be manually configured with an IP address, mask, and a gateway.

Dynamic Configuration

If a DHCP server is present on the network, the MQ-7200M will automatically obtain the network settings from the DHCP server when the DHCP function is enabled.

Step 1 : Enable the DHCP by checking the “**Enabled**” radio button.

Step 2 : Click on the “**Apply**” button to finish configuring the network settings.

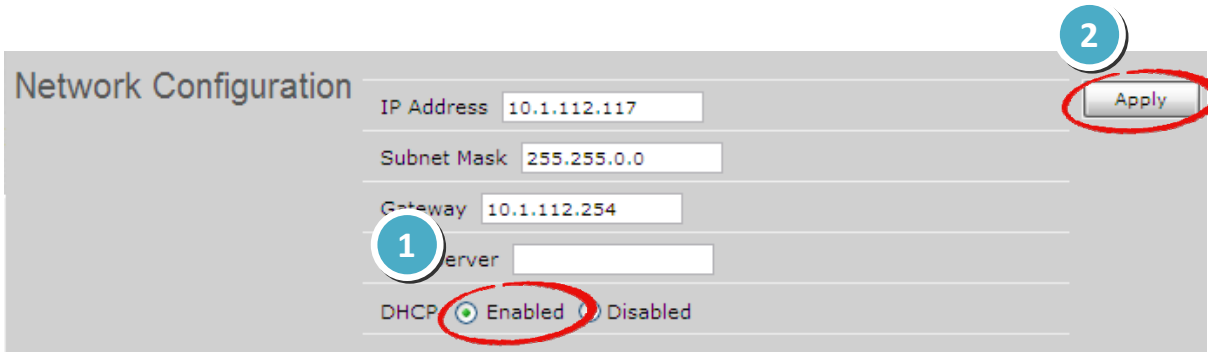

The screenshot shows the 'Network Configuration' page. The IP Address is 10.1.112.117, Subnet Mask is 255.255.0.0, and Gateway is 10.1.112.254. The DHCP Server field is empty. The DHCP radio buttons are 'Enabled' (selected) and 'Disabled'. A red circle highlights the 'Enabled' radio button, and another red circle highlights the 'Apply' button. A blue circle with the number '1' is next to the DHCP radio buttons, and a blue circle with the number '2' is next to the 'Apply' button.

Manual Configuration

When using manual configuration, all network settings need to be assigned manually. Each MQ-7200M module should have a unique IP address assigned to the interface in order to identify itself on the network.

Step 1 : Disable the DHCP by checking the “**Disabled**” radio button.

Step 2 : Enter the relevant network settings information into the respective fields .

Step 3 : Click the “ **Apply**” button to finish configuring the network settings.

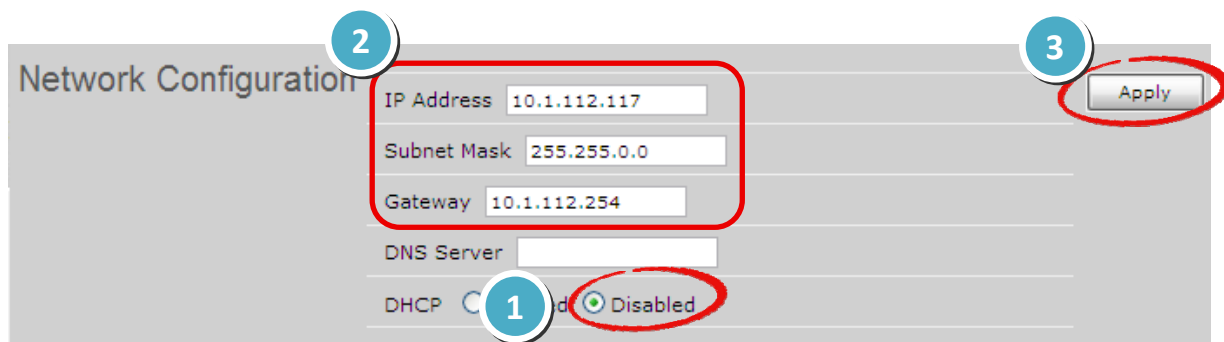

The screenshot shows the 'Network Configuration' page. The IP Address is 10.1.112.117, Subnet Mask is 255.255.0.0, and Gateway is 10.1.112.254. The DNS Server field is empty. The DHCP radio buttons are 'Disabled' (selected) and 'Enabled'. A red circle highlights the 'Disabled' radio button, and another red circle highlights the 'Apply' button. A blue circle with the number '1' is next to the DHCP radio buttons, a blue circle with the number '2' is next to the IP Address field, and a blue circle with the number '3' is next to the 'Apply' button.

DNS Server

DNS stands for domain name system whose main function is to translate domain names like www.icpdas.com to IP addresses and vice versa.

B Web Configuration

This section includes the following items:

- **Module Name:** The initial value for this field will depend on the model of the module and can not be modified.
- **Web Server Port:** This option specifies which port is to be used for the web server. By default, the HTTP port is 80.
- **Page Header Information (First line)** and **Page Header Information (Second line):** The title of the website that is displayed at the top left-hand corner of the interface, for example the company name and web address as per the example below.

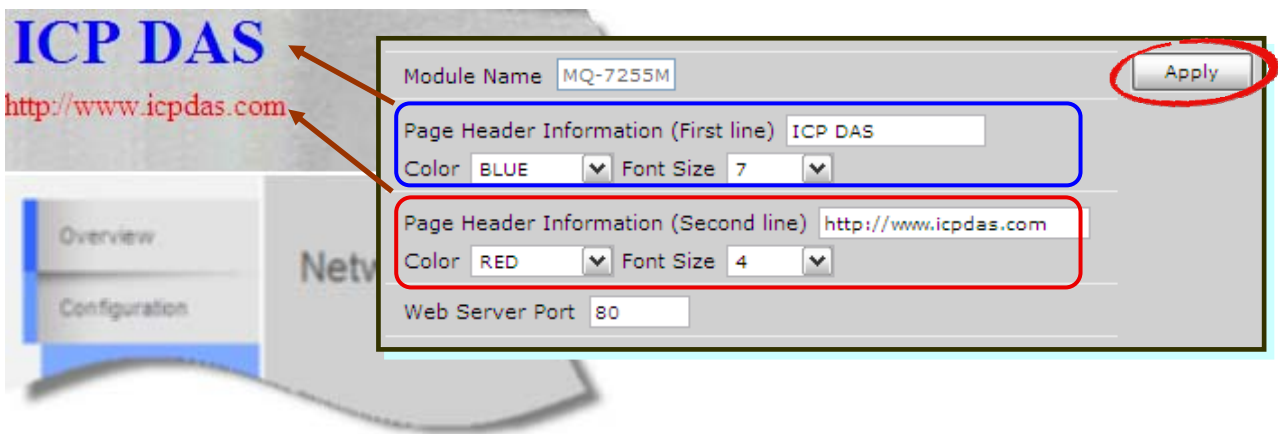

- Click on the “**Apply**” button if any item in this section is modified.

4.2. I/O Settings

Many industrial applications require a "safe" start-up status for output lines to prevent accidents when a module is powered on after normal or abnormal power off; and a safe output status if a host failure occurs or network communication problems take place.

On the **I/O Settings** page, Power-on Value and Safe Value for each output channel can be specified. Remember to click on the **"Apply"** button to update new settings.

The screenshot displays the I/O Settings configuration page. On the left sidebar, the 'I/O Settings' menu item is highlighted and circled in red. The main content area is divided into two sections: 'Power-on Value' and 'Safe Value'. Each section contains a list of output channels (DO0 to DO7) with radio button options for their respective settings. The 'Apply' buttons at the end of each section are also circled in red.

Channel	Power-on Value	Safe Value
DO0	<input checked="" type="radio"/> On <input type="radio"/> Off	<input checked="" type="radio"/> Maintain the current status <input type="radio"/> On <input type="radio"/> Off
DO1	<input checked="" type="radio"/> On <input type="radio"/> Off	<input checked="" type="radio"/> Maintain the current status <input type="radio"/> On <input type="radio"/> Off
DO2	<input type="radio"/> On <input checked="" type="radio"/> Off	<input checked="" type="radio"/> Maintain the current status <input type="radio"/> On <input type="radio"/> Off
DO3	<input type="radio"/> On <input checked="" type="radio"/> Off	<input checked="" type="radio"/> Maintain the current status <input type="radio"/> On <input type="radio"/> Off
DO4	<input checked="" type="radio"/> On <input type="radio"/> Off	<input checked="" type="radio"/> Maintain the current status <input type="radio"/> On <input type="radio"/> Off
DO5	<input type="radio"/> On <input checked="" type="radio"/> Off	<input checked="" type="radio"/> Maintain the current status <input type="radio"/> On <input type="radio"/> Off
DO6	<input type="radio"/> On <input checked="" type="radio"/> Off	<input checked="" type="radio"/> Maintain the current status <input type="radio"/> On <input type="radio"/> Off
DO7	<input type="radio"/> On <input checked="" type="radio"/> Off	<input checked="" type="radio"/> Maintain the current status <input type="radio"/> On <input type="radio"/> Off

- **Power-on Value:** This section is used to set the power-on value for each output channel. The power-on value will be loaded into the modules when the module is normally powered on or reset by Module Watchdog.



Step 1 : Check the **On/Off** radio button to set the power-on value for each channel.

Step 2 : Click the “ **Apply**” button to finish configuring the settings.

- **Safe Value:** This section is used to set the safe value for each output channel. Once the communication between the MQTT broker and the MQ-7200M is lost, the DO channels will be set to pre-defined safe value.

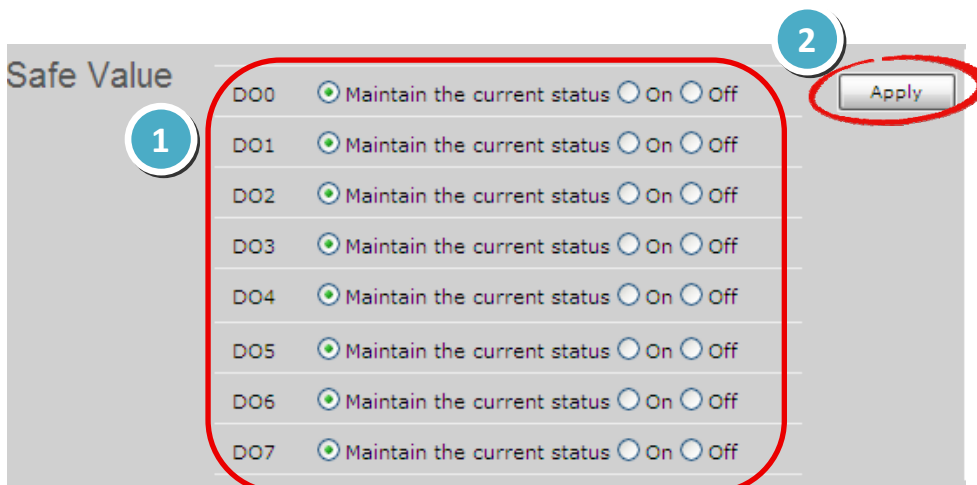

Step 1 : Check the radio button for **Maintain the current status/On/Off** to set the safe value for each channel.

Step 2 : Click the “ **Apply**” button to finish configuring the settings.

4.3. MQTT

MQTT is a Client Server publish/subscribe messaging transport protocol. It is light weight, open, simple, and designed so as to be easy to implement. These characteristics make it ideal for use in many situations, including constrained environments such as for communication in Machine to Machine (M2M) and Internet of Things (IoT) contexts where a small code footprint is required and/or network bandwidth is at a premium.

Citation from the official MQTT.org

As a MQTT client, the MQ-7200M series module can publish messages for status of digital I/O to a broker, and subscribe message for controlling DO lines from a broker. In a similar way, other MQTT clients can obtain the status of digital I/O by subscribing to a topic on the broker and publish message for controlling DO lines to the broker.

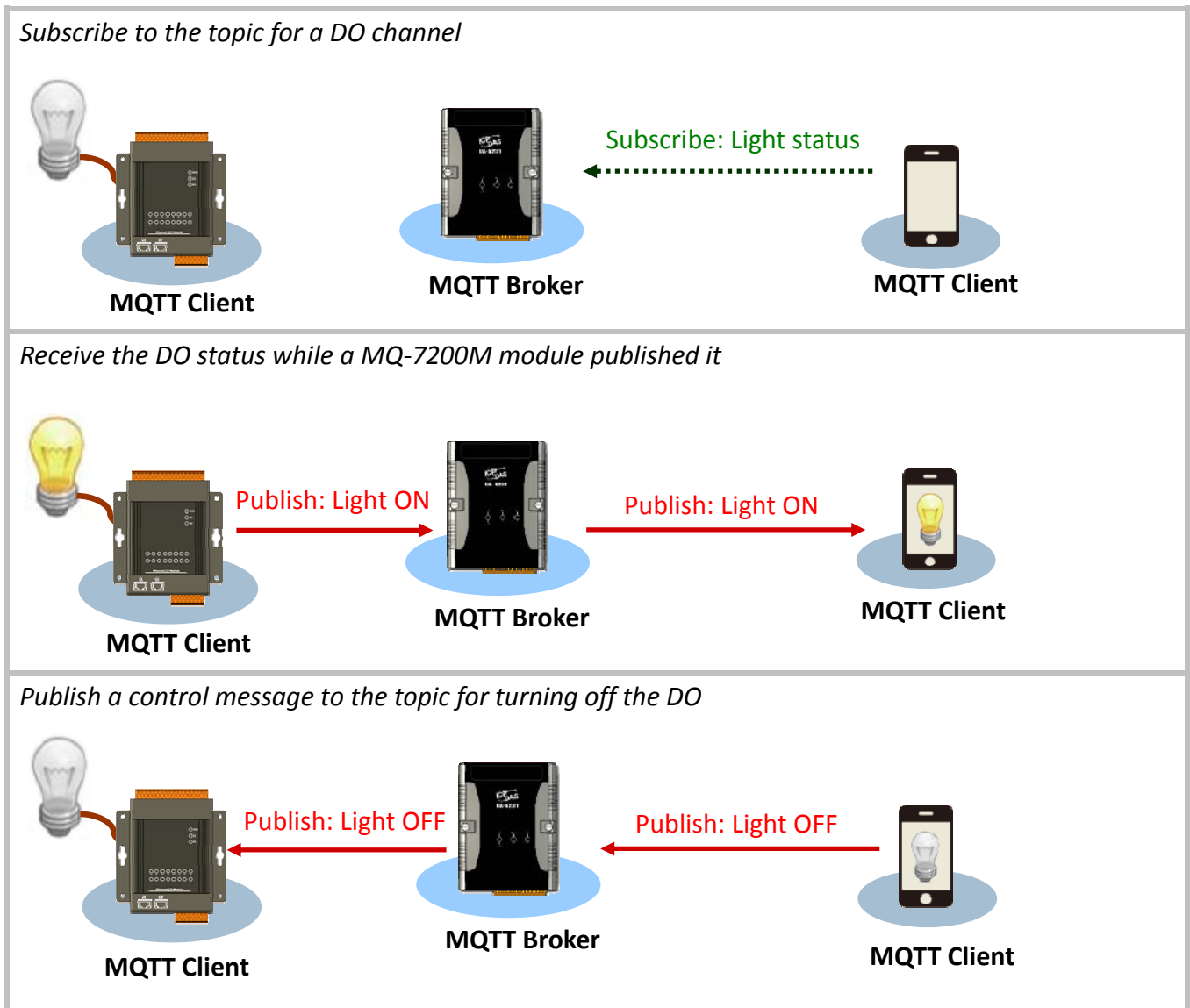

On the **MQTT** page, you can enable/disable the MQTT function, set the broker information, define the Last Will and Testament for announcing a module's offline message, and obtain the topic names for each I/O lines.

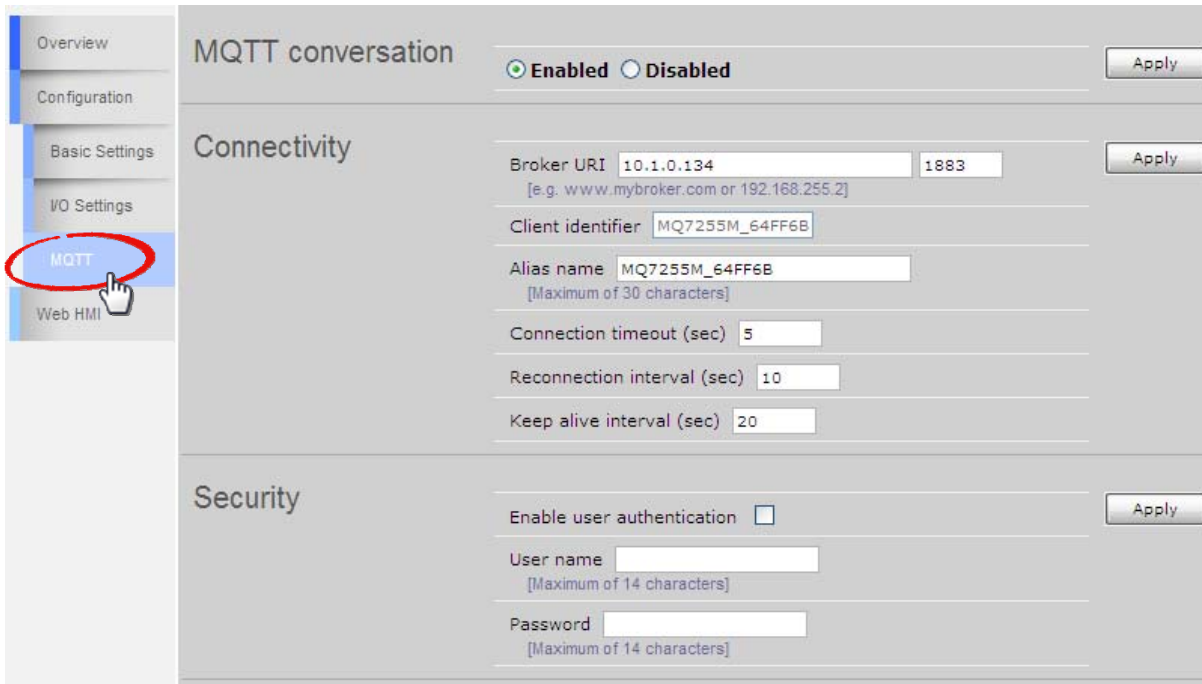

- **MQTT conversation:** You can enable/disable the MQTT function here. If the MQTT conversation is disabled, the module will stop to publish messages.

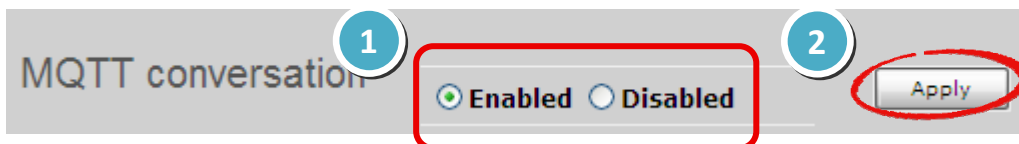

Step 1 : Check the **Enable** or **Disable** radio button to enable or disable MQTT function.

Step 2 : Click the “ **Apply**” button to finish configuring the settings.

- **Connectivity:** You can specify the broker in this section, set a human-readable alias for the module, time parameters for connection and time interval for Keep Alive.

Click on the “**Apply**” button if any item in this section is modified.

The screenshot shows a 'Connectivity' configuration panel with the following fields and values:

- Broker URI: 10.1.0.134 (with a port field set to 1883)
- Client identifier: MQ7255M_64FF6B
- Alias name: MQ7255M_64FF6B
- Connection timeout (sec): 5
- Reconnection interval (sec): 10
- Keep alive interval (sec): 20

An 'Apply' button is circled in red in the top right corner.

Item	Description
Broker URI	Enter the Broker URI and port for MQTT connection. The Broker URI can be an URL or an IP address.
Client identifier	The client identifier is an identifier of each MQTT client connecting to a MQTT broker. It should be unique to a broker, so that it consists of “module name”+ “_” (under line character) + “the last 6 digits of MAC address” and cannot be changed.
Alias name	Once the alias name is set, the first level of topics for accessing the module will become alias instead of client identifier default. An alias name should be unique to identify one module from others. It is a user-friendly identifier to make a topic more readable.
Connection timeout (Unit: second)	Defines the maximum time interval that the MQ-7200M will wait for establishing the connection with a MQTT broker. (Default: 30 seconds)
Reconnection interval (Unit: second)	The time interval for that the MQ-7200M will retry to connect to the broker if a connection failure occurs.
Connection keep alive (Unit: second)	The keep-alive mechanism is provided to ensure that both a client and a broker are alive and the connection is still open. If a client doesn't send any messages during the period of the keep alive, it must send a PINGREQ packet to the broker to confirm its availability. And the broker must reply with a PINGRESP packet to indicate its availability. The broker will disconnect a client, which doesn't send PINGREQ or any other message in one and a half time of the keep alive interval. (Default: 20 seconds)

- **Security:**

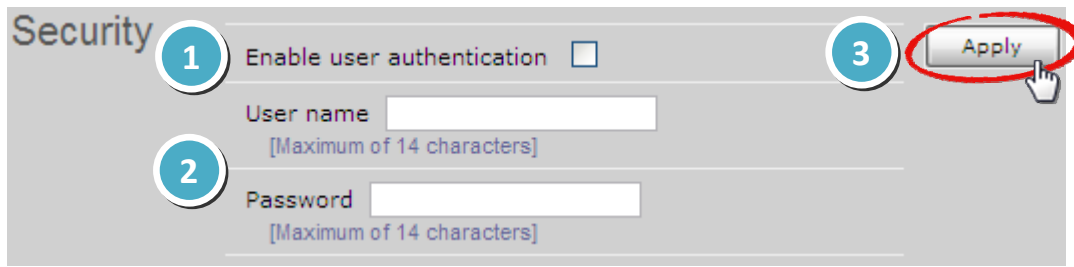

If your MQTT broker requests a user name and a password to authenticate clients:

Step 1 : Tick the **Enable user authentication** option.

Step 2 : Fill in both a user name and a password.

Step 3 : Click on the **“Apply”** button to update the settings.

- **Last Will:** The MQTT Last Will and Testament (LWT) feature is used to notify other clients about an ungracefully disconnected client. A MQ-7200M can register an offline message (LWT) to the broker. The LWT message will be delivered to all clients who subscribe to the offline topic if the MQ-7200M disconnects unexpectedly.

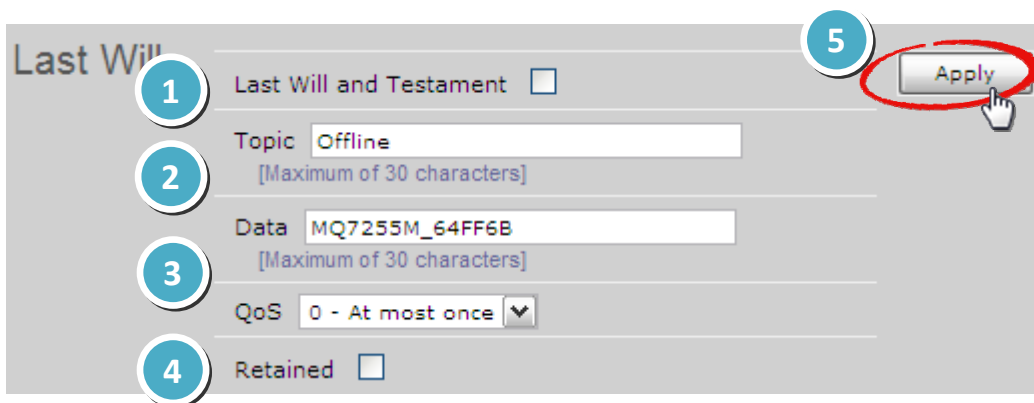

If you would like to enable the LWT feature:

Step 1 : Tick the **Last Will and Testament** option.

Step 2 : Fill in the topic and data for the LWT message.

Step 3 : Set the QoS for the LWT message. The default is 0.
It is in conjunction with the LWT message.

Step 4 : Tick the **Retained** option if the LWT message needs be retained on the broker.
It is in conjunction with the LWT message.

Step 5 : Click on the **“Apply”** button to update the settings.

- **Subscriptions:** In this section, the topics for each DO channel are listed from first channel to last as below. The MQ-7200M will automatically subscribe to all topics listed in this section after boot-up if MQTT conversation at the top of this page is enabled.

Subscriptions		
I/O	No.	Topic
Digital Output	0	F001/SetValue/F001
Digital Output	1	F001/SetValue/DO1
Digital Output	2	F001/SetValue/DO2
Digital Output	3	F001/SetValue/DO3
Digital Output	4	F001/SetValue/DO4
Digital Output	5	F001/SetValue/DO5
Digital Output	6	F001/SetValue/DO6
Digital Output	7	F001/SetValue/DO7

A DO operation will be divided into two steps. For example, to turn off the Digital Output 1, the steps are:

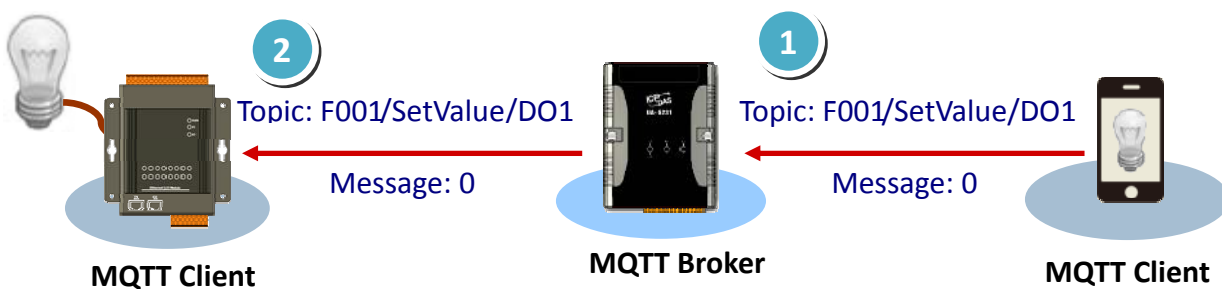

- 1 A MQTT client publishes message **0** to the topic for Digital Output 1 on the broker.
- 2 The broker publishes the message to subscribers including the MQ-7200M, and then the MQ-7200M turns off the channel corresponding to the topic.

A topic for each DI/DO channel on a MQ-7200M module consists of 3 topic levels; each topic level is separated by a forward slash:

For example

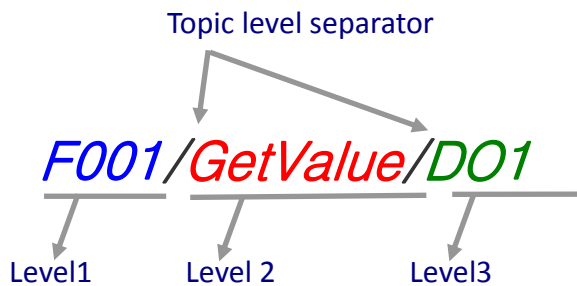

Level 1: It is default to client identifier; once the alias name is set, it will become alias name instead of client identifier.

Level 1	
Client identifier	If alias name is empty. (Default)
Alias name	If alias name is set.

Level 2: It is fixed and can not be changed.

Level 2	
GetValue	The topics are for a MQ-7200M to publish message of value or status on both input and output channels. User's clients can subscribe the topics to get values.
SetValue	The topics are for user's clients to publish message to set value to output channels. The MQ-7200M module specified in level 1 will execute the output command.

Level 3: It can be changed by modifying Level 3 in the following section.

If the level 3 of a topic for getting value from an output channel is modified, the level 3 of a topic for setting value to the same channel will be synchronously modified.

- **Publications:** Time-driven and event-driven publishing processes are both supported to publish I/O status to the topics listed in this section. The I/O status will be published periodically with a time interval of the value set in the Publish interval (sec) and in case an event for I/O status changed.

I/O	No.	Topic
Digital Output	0	F001/GetValue/F001
Digital Output	1	F001/GetValue/DO1
Digital Output	2	F001/GetValue/DO2
Digital Output	3	F001/GetValue/DO3
Digital Output	4	F001/GetValue/DO4
Digital Output	5	F001/GetValue/DO5
Digital Input	3	F001/GetValue/DI3
Digital Input	4	F001/GetValue/DI4
Digital Input	5	F001/GetValue/DI5
Digital Input	6	F001/GetValue/DI6
Digital Input	7	F001/GetValue/DI7

QoS: 0 - At most once

Publish interval (sec): 20
[0: Disabled, 10~600: Enabled]

Apply

Step 1 : Verify the topic name for each channel; or modify the topic 3 if need.

Level 3 of topics for I/O channels is up to 16 characters, which can be modified to a user-friendly name (string) here. Each one should be unique in order to be identified. The forward slash can be used to create a sub level to group several channels together. It is helpful to manage a variety of sensors.

The level 3 of a topic for setting value to a DO channel in Subscriptions section will be synchronously changed if level 3 of a topic for the same channel is changed here.

Step 2 : Select the QoS level.

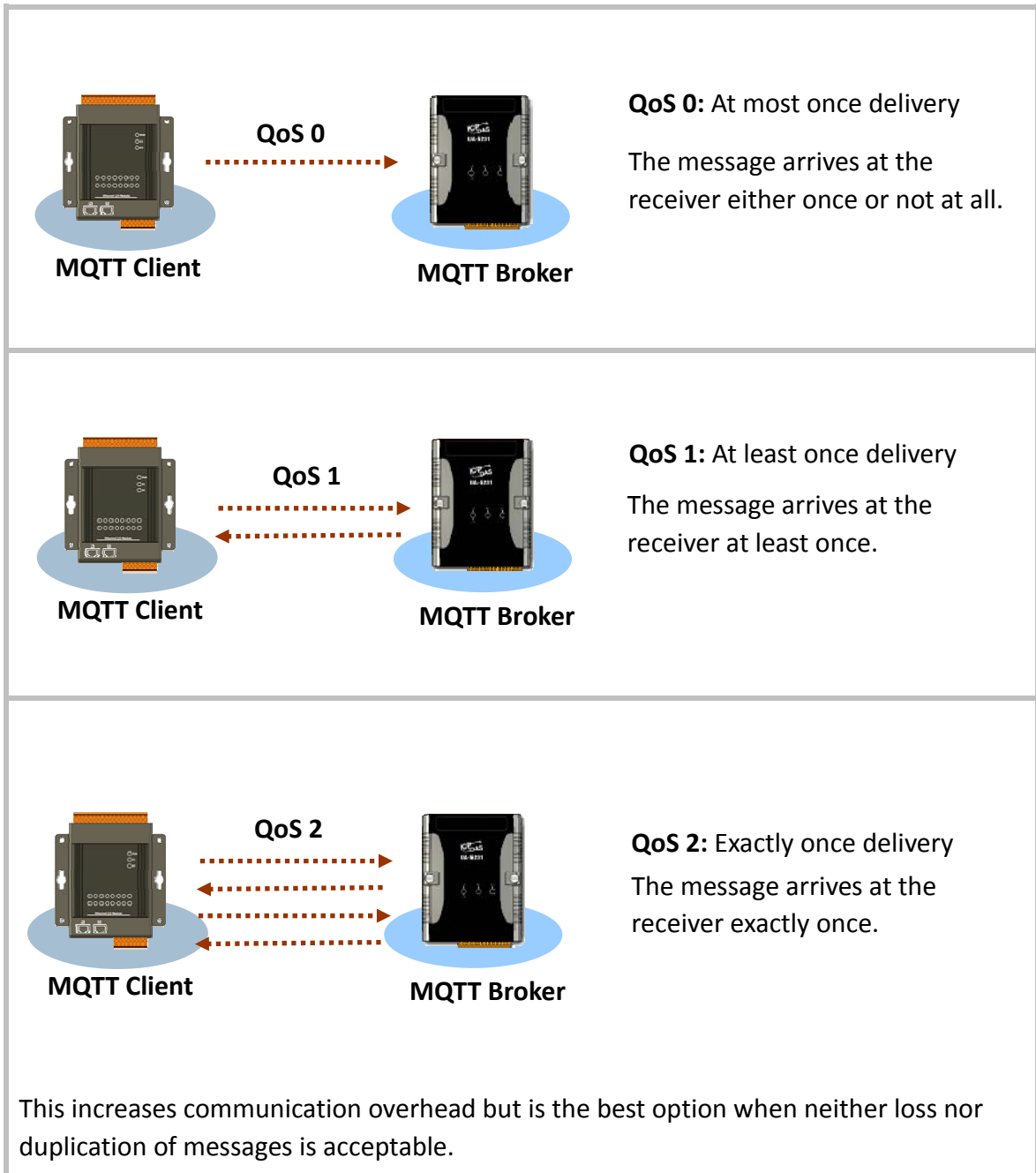

Step 3 : Set the time interval to periodically publish I/O status on the MQ-7200M module. Time-driven and Event-driven publishing processes are both supported when a time interval in range from 10 to 600 seconds is set.

A setting value of 0 will disable the time-driven message-delivering process. Messages will be published to MQTT broker immediately only when a status of digital I/O changes.

Step 4 : Click on the “Apply” button to update the new settings.

5. Web HMI

On this Web HMI page, you can get the following information

1. Connection status between your browser and the MQ-7200M module,
2. Connection status between the MQ-7200M module and the broker you set,
3. The I/O status of each channel.

And you can control the output channels by clicking on the On or Off button.

The screenshot shows a web interface with a sidebar menu on the left containing: Overview, Configuration, Basic Settings, I/O Settings, MQTT, and Web HMI (highlighted with a red circle and a mouse cursor). The main content area is titled "Network Connection" and displays a connection diagram: "This computer" connected to "F001" (MQ-7200M module), which is connected to "Broker". Below this is a table of I/O channels.

I/O	No.	Topic	Status
Digital Output	0	F001/GetValue/Room01/Light01	ON <input type="button" value="On"/> <input type="button" value="Off"/>
Digital Output	1	F001/GetValue/Room01/Light02	ON <input type="button" value="On"/> <input type="button" value="Off"/>
Digital Output	2	F001/GetValue/Room01/Light03	OFF <input type="button" value="On"/> <input type="button" value="Off"/>
Digital Input	0	F001/GetValue/DI0	ON
Digital Input	1	F001/GetValue/DI1	ON
Digital Input	2	F001/GetValue/DI2	OFF
Digital Input	3	F001/GetValue/DI3	OFF
Digital Input	4	F001/GetValue/DI4	ON
Digital Input	5	F001/GetValue/DI5	OFF
Digital Input	6	F001/GetValue/DI6	OFF
Digital Input	7	F001/GetValue/DI7	OFF

- **Network Connection:** This section displays connection status to your computer and to the broker on the MQ-7200M module.

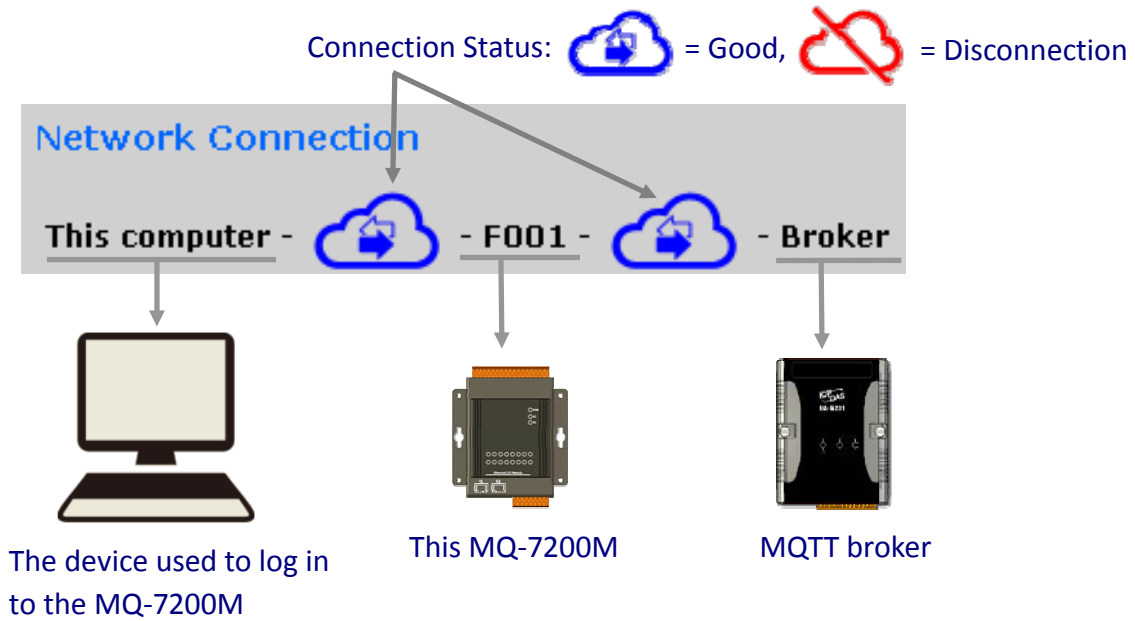

- **I/O:** Digital Output 0 ~ [N-1], N = the total DO channel number on the MQ-7200M.

I/O	No.	Topic	Status	
Digital Output	0	F001/GetValue/Room01/Light01	ON	<input type="button" value="On"/> <input type="button" value="Off"/>
Digital Output	1	F001/GetValue/Room01/Light02	ON	<input type="button" value="On"/> <input type="button" value="Off"/>
Digital Output	2	F001/GetValue/Room01/Light03	OFF	<input type="button" value="On"/> <input type="button" value="Off"/>
Digital Output	3	F001/GetValue/Room01/Light04	OFF	<input type="button" value="On"/> <input type="button" value="Off"/>
Digital Output	4	F001/GetValue/DO4	ON	<input type="button" value="On"/> <input type="button" value="Off"/>
Digital Output	5	F001/GetValue/DO5	OFF	<input type="button" value="On"/> <input type="button" value="Off"/>
Digital Output	6	F001/GetValue/DO6	OFF	<input type="button" value="On"/> <input type="button" value="Off"/>
Digital Output	7	F001/GetValue/DO7	OFF	<input type="button" value="On"/> <input type="button" value="Off"/>



- **I/O**: Digital Input 0 ~ [N-1], N = the total DI channel number on the MQ-7200M.

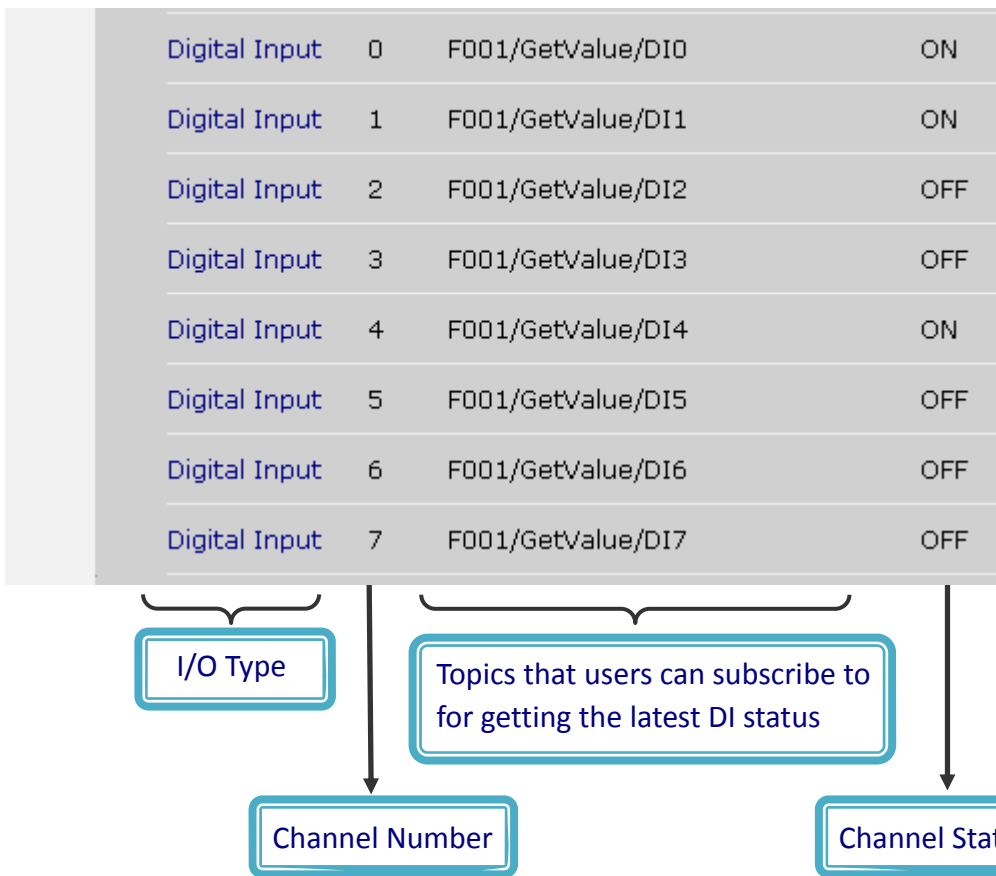

6. MiniOS7 Utility Tools

MiniOS7 Utility is a tool for uploading firmware to flash memory and updating the OS to MQ-7200M module embedded with MiniOS7 with easiness and quickness.

If you haven't the MiniOS7 Utility installed on your system, installation of the MiniOS7 Utility should be the first step. Please refer to section "3.2 Installing the MiniOS7 Utility" to install it.

6.1. Establishing a Connection

To upload firmware or update the OS to MQ-7200M module, you must first establish a connection between PC and the MQ-7200M module.

Step 1 : Run the MiniOS7 Utility

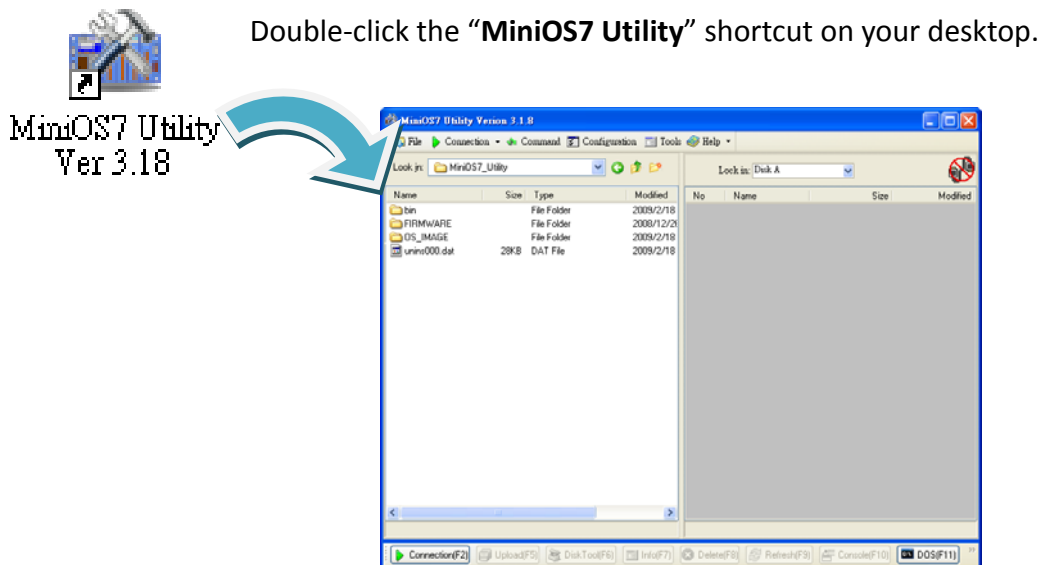

Step 2 : Press the “F12” key or choose the “Search” option from the “Connection” menu

After pressing the “F12” key or choosing the “Search” option from “Connection” menu, the utility perform a search of all MiniOS7 modules on your network.

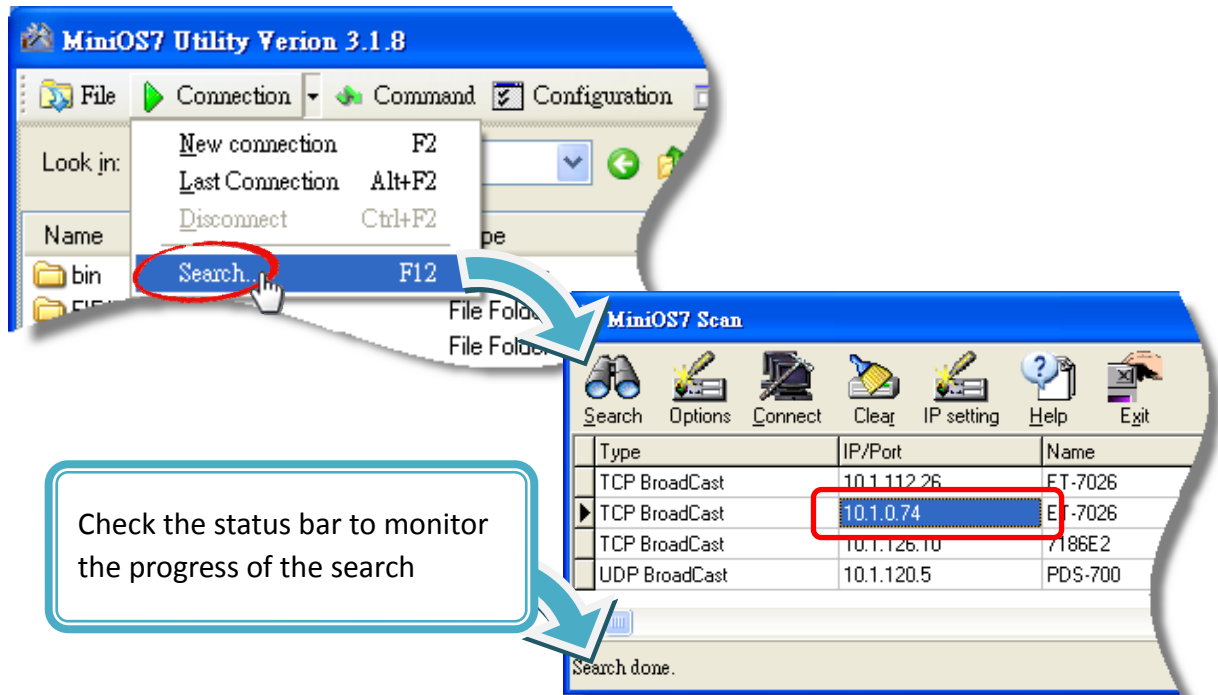

Check the status bar to monitor the progress of the search

Step 3 : Click the IP address in the IP/Port field list and then click the “Connect” icon in the toolbar.

After the search has been completed, click the IP address for the MQ-7200M module in the IP/Port field list and then click the “Connect” icon in the toolbar to connect to the MQ-7200M.

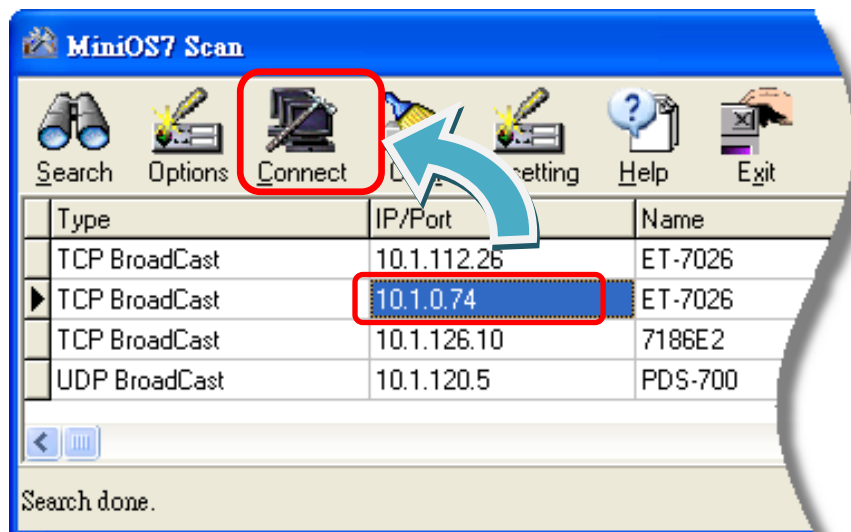

Check the connection symbol to make sure that the connection is established

A connection symbol Check the connection symbol status in the top right side to make sure the connection has been established

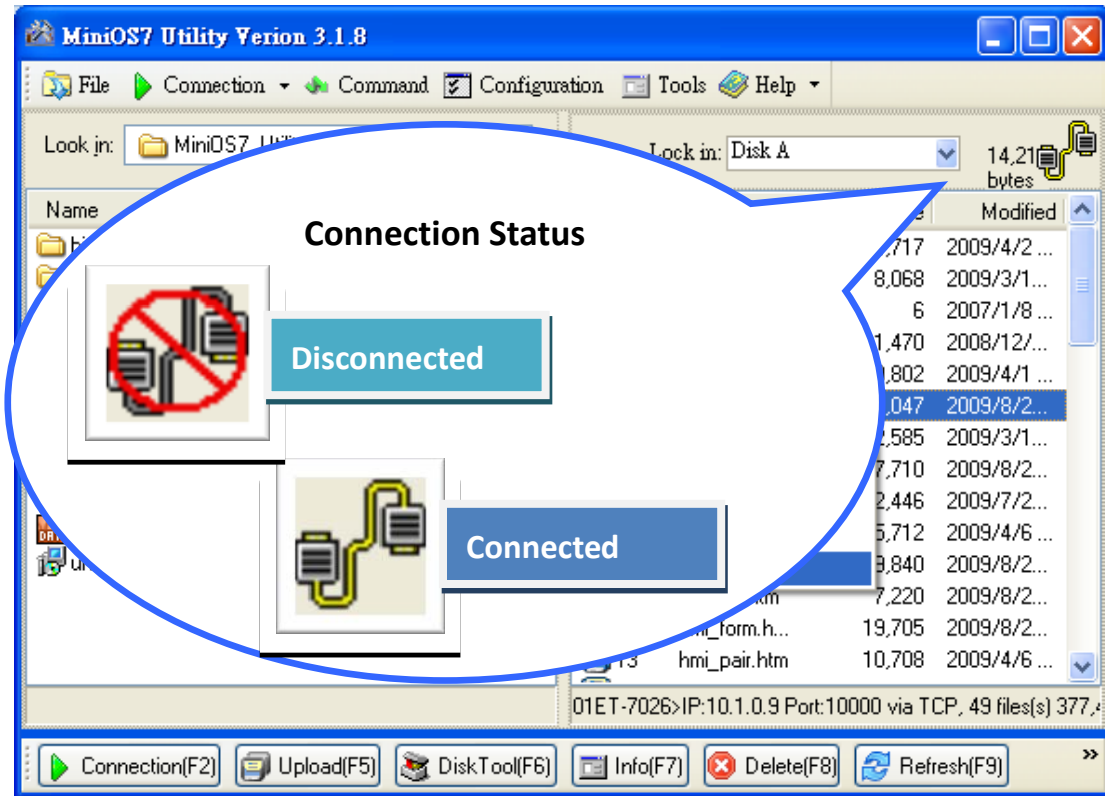

6.2. Exchanging the Protocol (TCP/IP to UDP)

MiniOS7 Utility supports both UDP and TCP protocols. For MiniOS7 Utility, the TCP/IP is the default protocol for communicating with MQ-7200M, and the UDP is used to update the OS. Therefore, if you want to update the OS, you might need to change protocols to support them.

Step 1 : Establish a connection to the MQ-7200M

For a more detailed description of this instruction, please refer to section “6.1. Establishing a Connection”.

Step 2 : Right Click the file list of the right side window, and then choose “Quit Firmware” to stop the firmware running

Right click the file list of the right side windows, and then choose “Quit Firmware” to stop the firmware running and exchange TCP/IP protocol to UDP protocol.

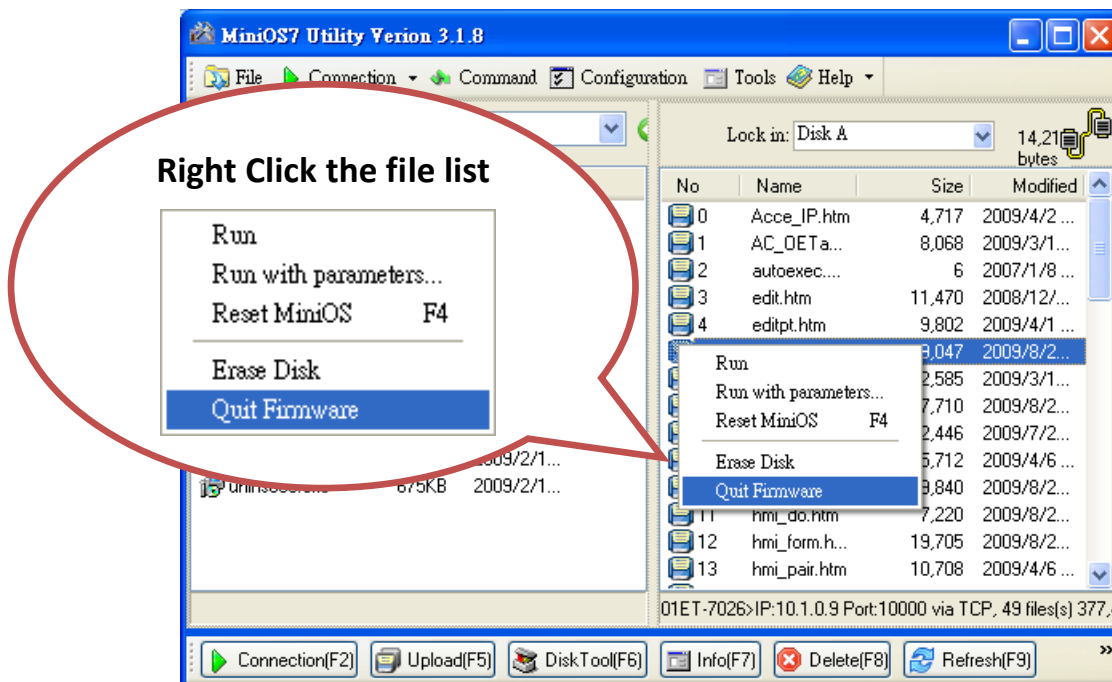

Step 3 : Click the “Yes” button to continue

After executing the Quick Firmware command, the “Confirm” dialog will appear, and then click “Yes” button to continue and stop the firmware running.

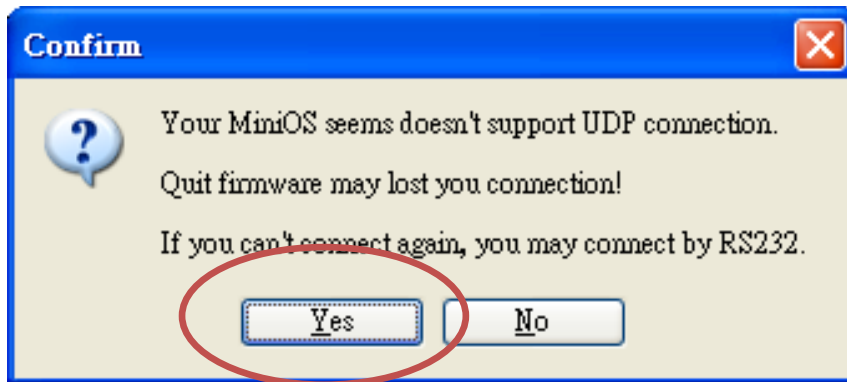

Step 4 : Click “Yes” to continue

After confirming the command, the “Confirm” dialog will appear, and then click “Yes” button to exchange UDP protocol for TCP protocol.

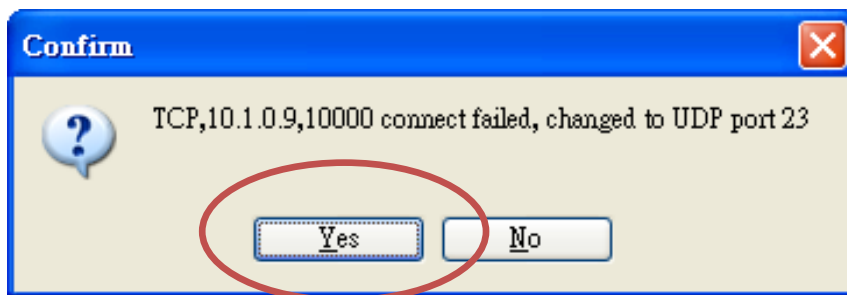

Step 5 : The changes have been affected

6.3. Updating the MQ-7200M OS

Additional features to MQ-7200M OS will continue to be added in the future, so we advise you to periodically check with ICPDAS web site for the latest updates.

Step 1 : Download the latest version of the MiniOS7 OS image

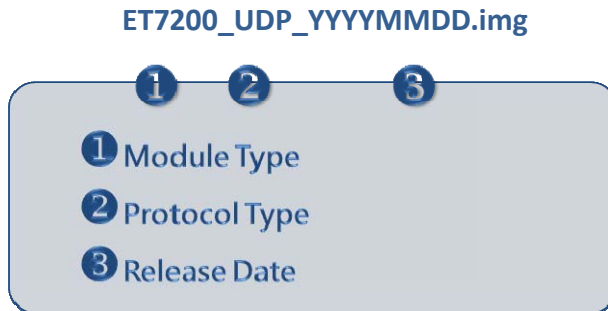

The latest version of the MiniOS7 OS image can be obtained from the companion the ICP DAS FTP site at:

http://ftp.icpdas.com/pub/cd/mq-7200m/os_image

Step 2 : Establish a connection to MQ-7200M.

NOTE

- Be sure that the MiniOS7 Utility is connecting with the MQ-7200M using the UDP connection. For a more detailed description of this instruction, refer to the section “6.2. Exchanging the Protocol (TCP/IP to UDP)”.

Step 3 : Choose “Update MiniOS7 Image” from the “File” menu

Choose “Update MiniOS7 Image” from File menu to start the update procedure.

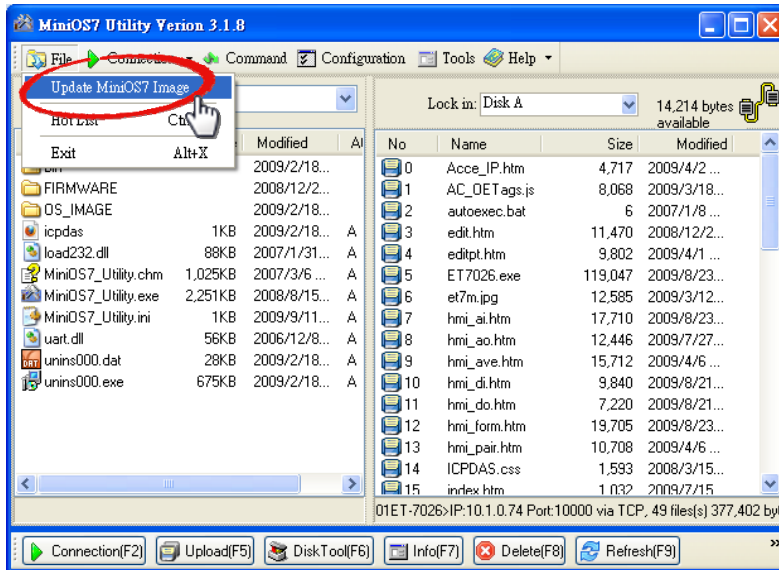

Step 4 : Select the latest version of the MiniOS7 OS image

After choosing the update MiniOS7 Image command, the “Select MiniOS7 Image file” dialog will appear, and then select the latest version of the MiniOS7 OS image.

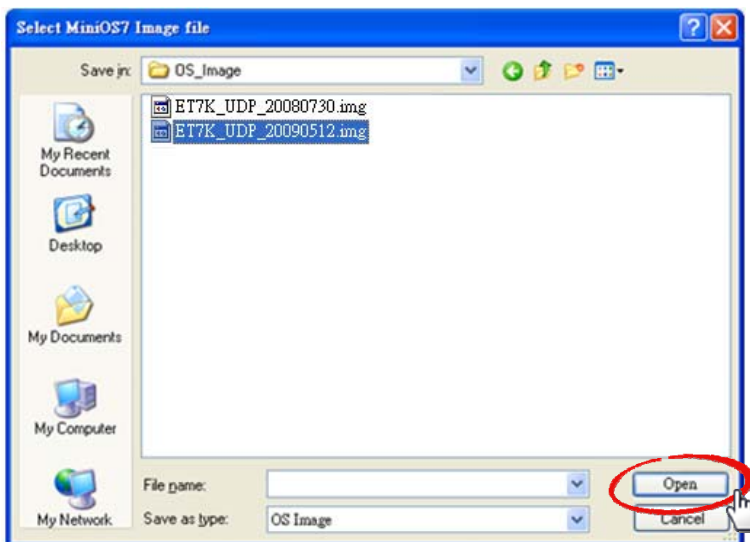

Step 5 : Click “OK” to finish the procedure

After confirming the command, you just need to wait awhile until the following dialog appear, and then click “OK” button to finish the procedure.

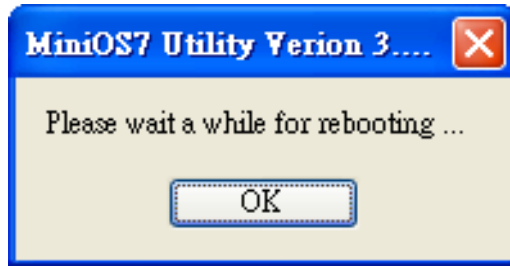

Step 6 : Press “F7” or choose “Info” from the “Command” menu to check the OS version

After pressing “F7” or choosing info from “Command” menu to check the OS version.

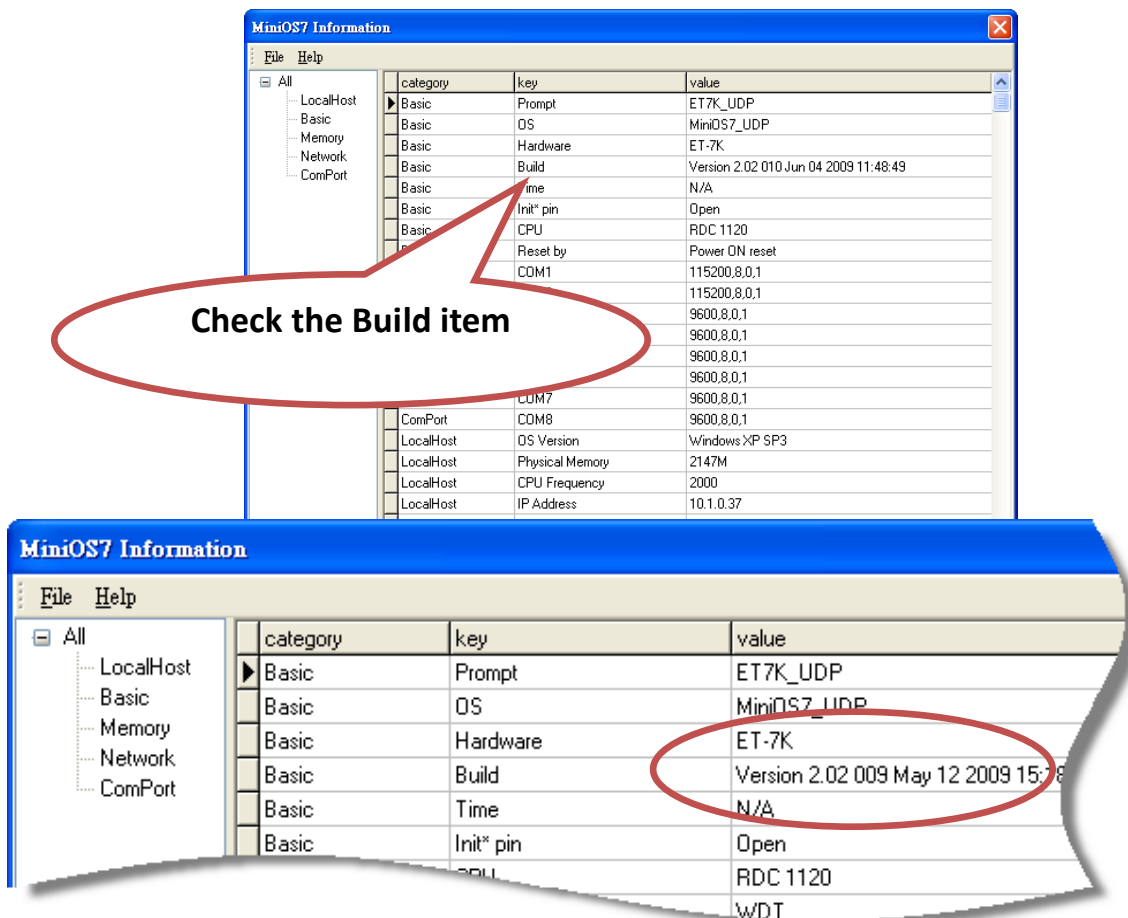

6.4. Updating the MQ-7200M Firmware

The firmware is stored in flash memory and can be updated to fix functionality issues or add additional features, so we advise you to periodically check the ICP DAS web site for the latest updates.

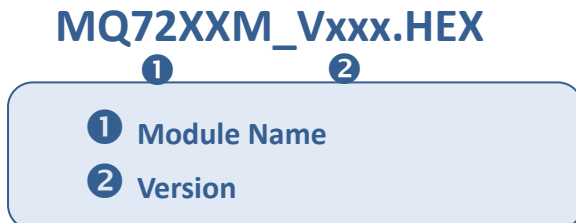

The latest version of the MQ-7200M firmware can be obtained from:

<http://ftp.icpdas.com/pub/cd/mq-7200m/firmware>

Step 1 : Establish a connection to connection to the MQ-7200M.

NOTE

- Be sure that the MiniOS7 Utility is connecting with the MQ-7200M using the UDP connection. For a more detailed description of this instruction, refer to the section “6.2. Exchanging the Protocol (TCP/IP to UDP)”.
-

Step 2 : Choose “Erase Disk” from the “Command” menu

After establishing a UDP connection, then choose “Erase Disk” from Command menu (or right-click on the right of window) to delete all files from the flash memory.

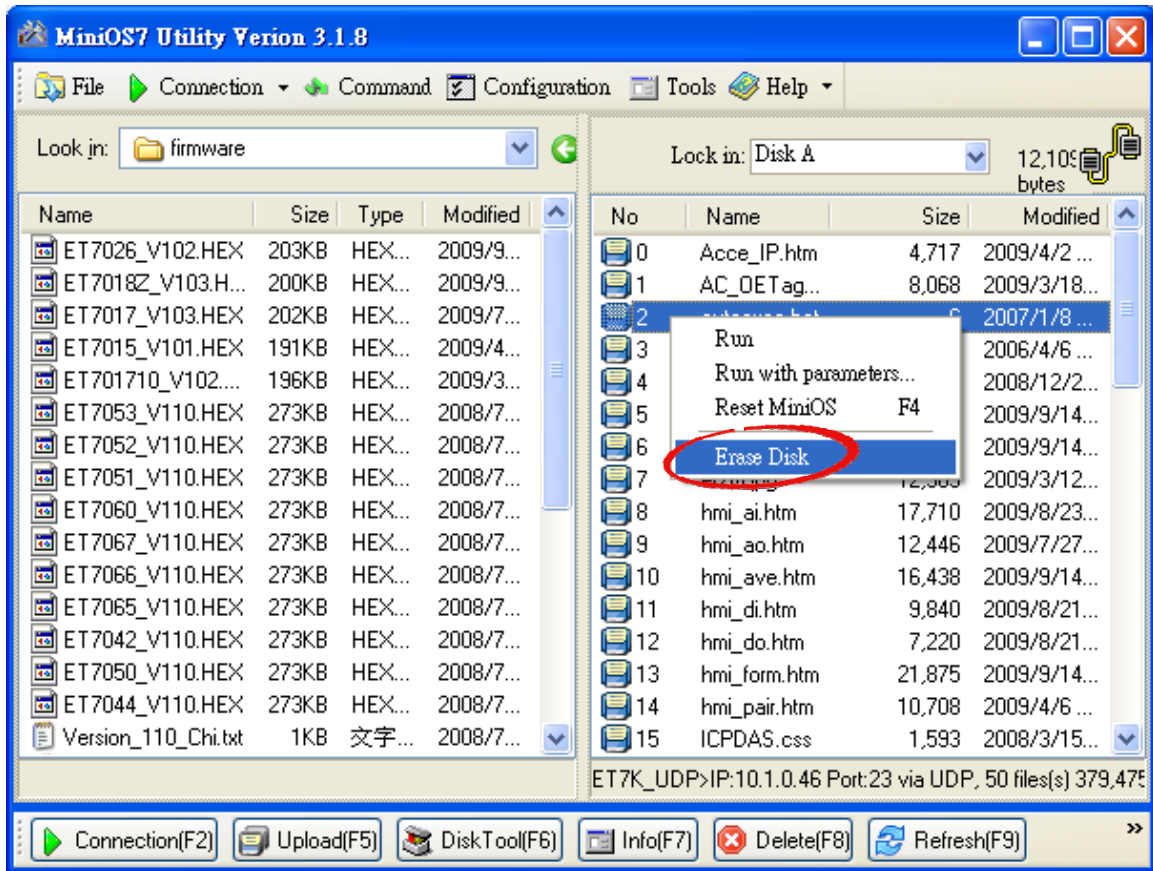

Tips & Warnings



You have to delete all files existed on the MQ-7200M before uploading the firmware.

Step 3 : In the Confirm dialog box, click the “Yes” button to continue.

After executing the Erase Disk command, the Confirm dialog will appear, and then click “Yes” button to continue erasing the memory contents.

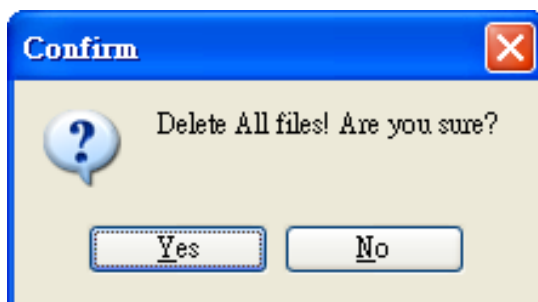

Step 4 : Select the latest version of the firmware.

Right-click on the firmware which is downloaded on your computer and select Upload to start the upload process.

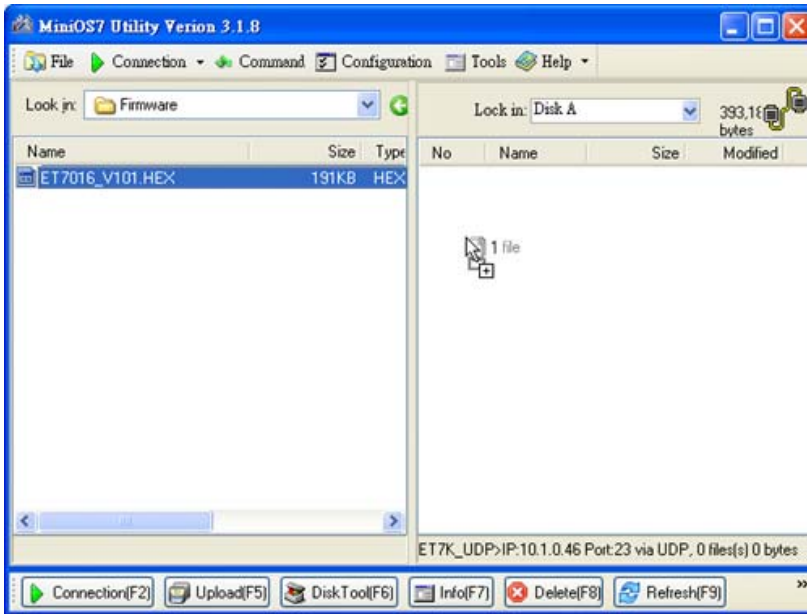

Step 5 : Click "OK" to finish and reboot the module.

After confirming the command, you just need to wait awhile until the following dialog appear, and then click "OK" button to finish the procedure. After the update is completed, recycle power to the module.

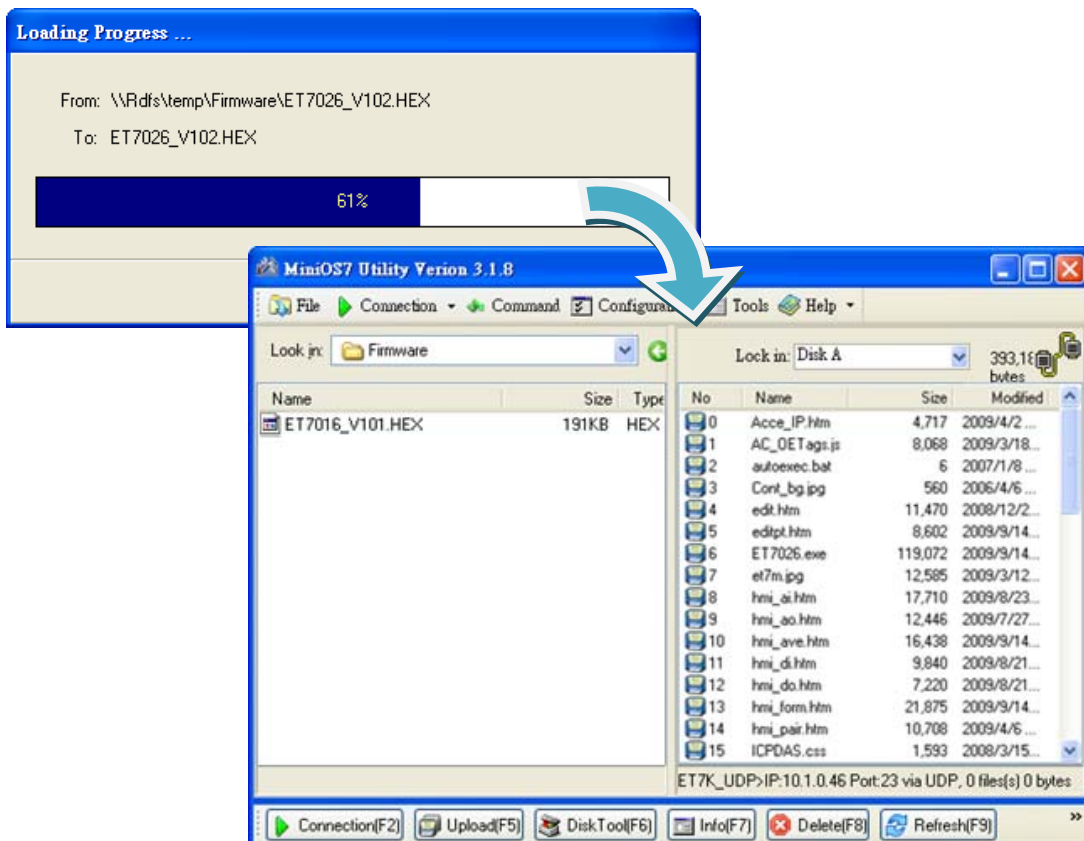

7. FAQ

7.1. How to publish I/O status message to an MQTT broker?

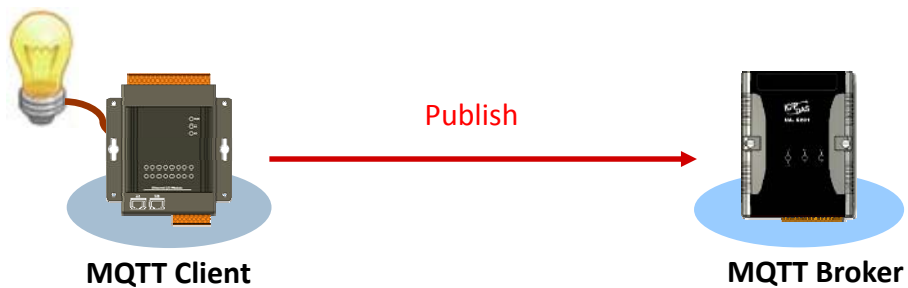

1. Log in to the MQ-7200M and go to MQTT page.
2. Make sure the **Enable** radio button for MQTT conversation is selected.
3. Enter the Broker URI and port number for MQTT connection.
4. Press the Apply button to update the settings.

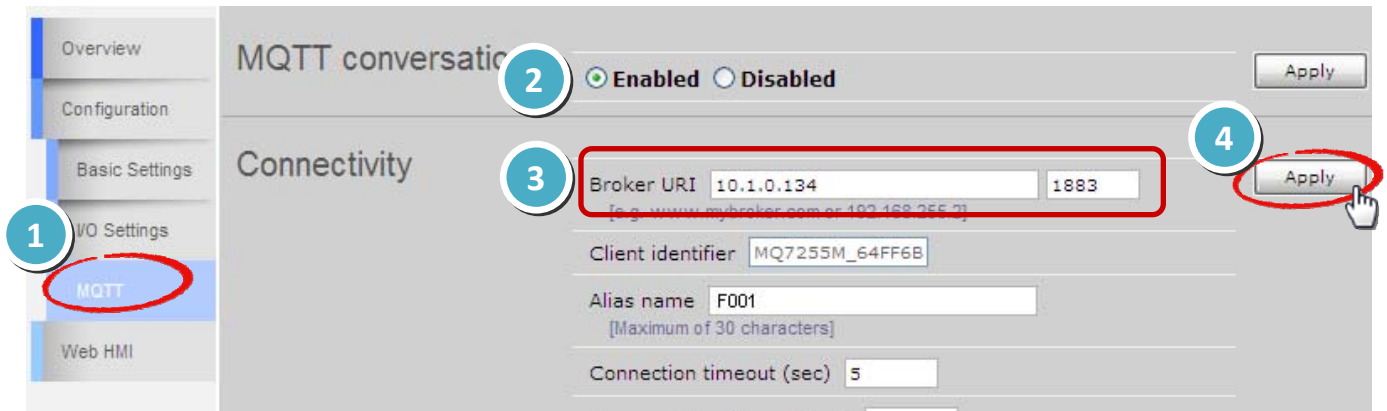

5. Go to Web HMI page and make sure the connection between the MQ-7200M and broker is created.

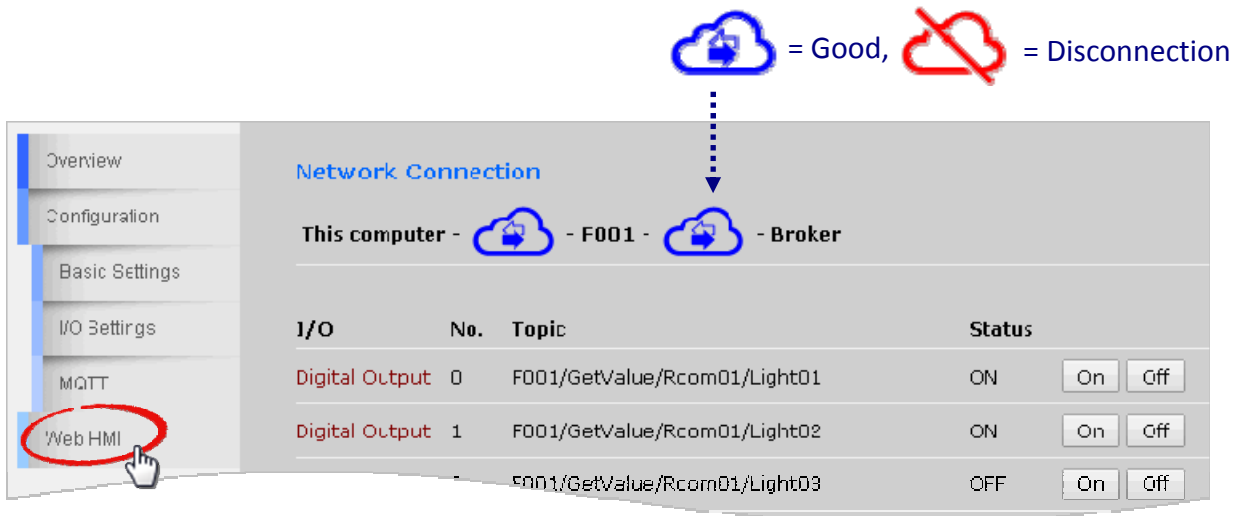

6. Go to Publications section on MQTT page, I/O status will be published to corresponding topic listed here one by one to the MQTT broker.

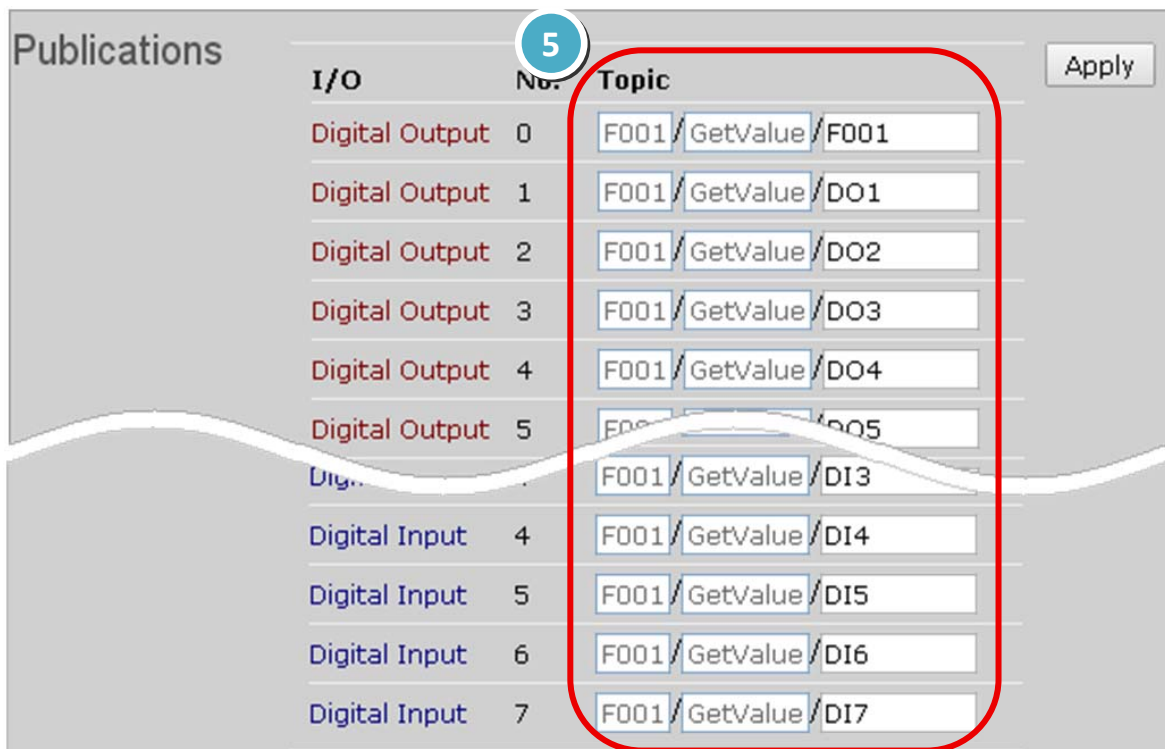

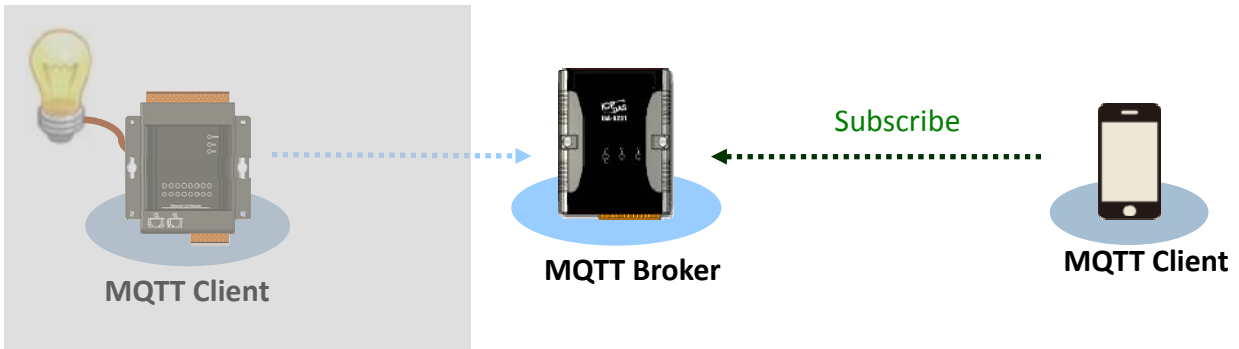

7.2. How to subscribe I/O status on a MQ-7200M?

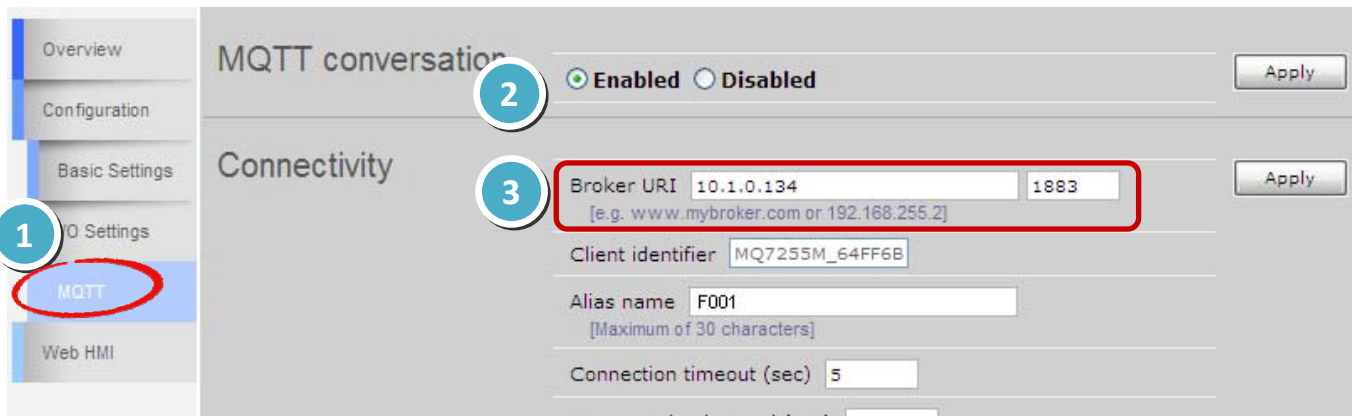

1. Log in to the MQ-7200M and go to MQTT page.
2. Make sure the **Enable** radio button for MQTT conversation is selected.
3. Get the broker URI and port number.



4. Go to Web HMI page and make sure the connection between the MQ-7200M and broker is created.

 = Good,
  = Disconnection

I/O	No.	Topic	Status
Digital Output	0	F001/GetValue/Rcom01/Light01	ON <input type="button" value="On"/> <input type="button" value="Off"/>
Digital Output	1	F001/GetValue/Rcom01/Light02	ON <input type="button" value="On"/> <input type="button" value="Off"/>
		F001/GetValue/Rcom01/Light03	OFF <input type="button" value="On"/> <input type="button" value="Off"/>

5. Go to Publications section on MQTT page, I/O status will be published to corresponding topic listed here. Subscribe to the topic on the broker via your client device to get I/O status. On status is signified by a “1” and off is “0”.

The screenshot shows a 'Publications' section with a table of I/O components and their MQTT topics. The 'I/O' column is highlighted with a blue circle containing the number '5'. The 'Topic' column is highlighted with a red circle. An 'Apply' button is visible in the top right corner.

I/O	Topic
Digital Output 0	F001/GetValue/F001
Digital Output 1	F001/GetValue/DO1
Digital Output 2	F001/GetValue/DO2
Digital Output 3	F001/GetValue/DO3
Digital Output 4	F001/GetValue/DO4
Digital Output 5	F001/GetValue/DO5
Digital Output 6	F001/GetValue/DO6
Digital Output 7	F001/GetValue/DO7
Digital Input 4	F001/GetValue/DI4
Digital Input 5	F001/GetValue/DI5
Digital Input 6	F001/GetValue/DI6
Digital Input 7	F001/GetValue/DI7

7.3. How to control DO channel on a MQ-7200M?

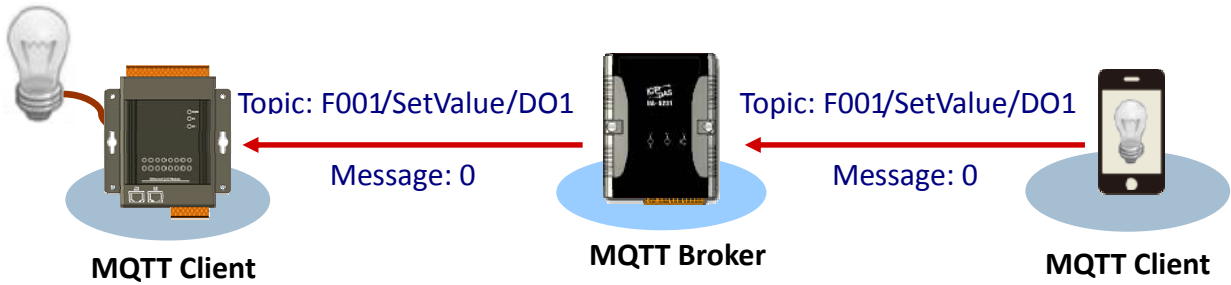

1. Log in to the MQ-7200M and go to MQTT page.
2. Make sure the **Enable** radio button for MQTT conversation is selected.
3. Get the broker URI and port number.

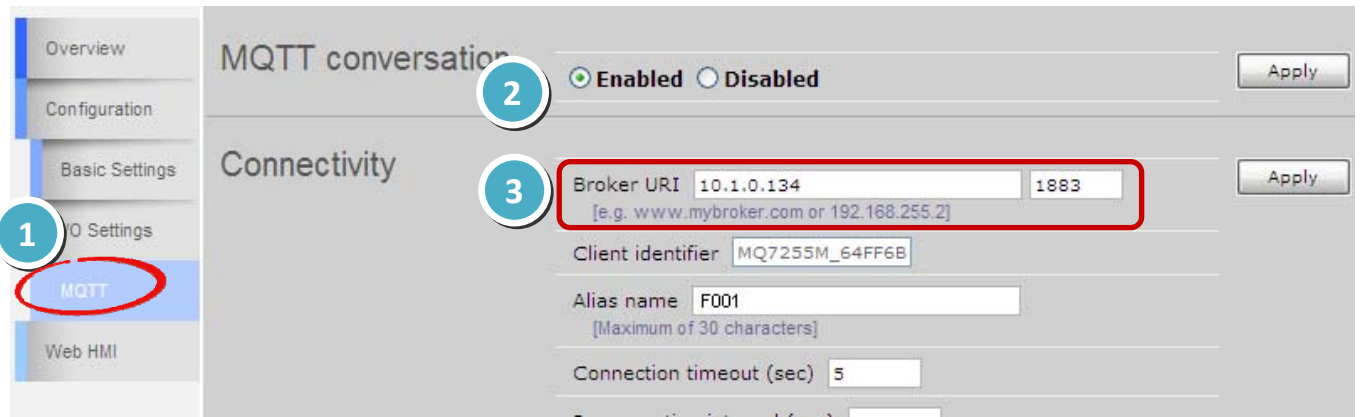

4. Go to Web HMI page and make sure the connection between the MQ-7200M and broker is created.

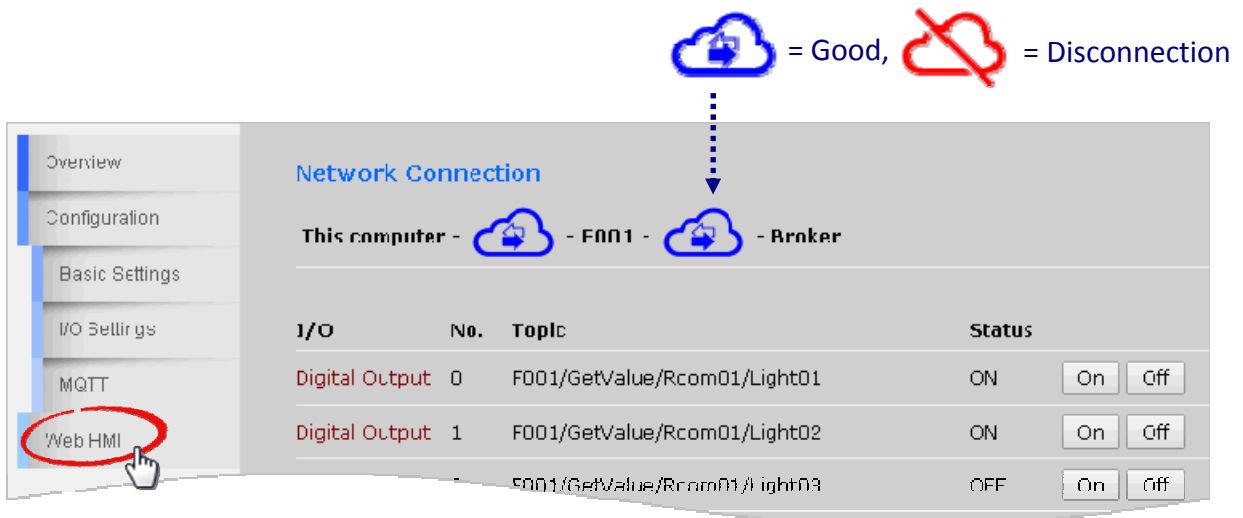

5. Go to Subscriptions section on MQTT page, MQ-7200M will automatically subscribe to all topics listed here. Publish to the corresponding topic on the broker; message 0 will turn off a channel and message 1 will turn on the channel.

Subscriptions		
I/O	No.	Topic
Digital Output	0	F001/SetValue/F001
Digital Output	1	F001/SetValue/DO1
Digital Output	2	F001/SetValue/DO2
Digital Output	3	F001/SetValue/DO3
Digital Output	4	F001/SetValue/DO4
Digital Output	5	F001/SetValue/DO5
Digital Output	6	F001/SetValue/DO6
Digital Output	7	F001/SetValue/DO7

7.4. How to restore MQ-7200M to default settings?

If the network configuration on the MQ-7200M is lost, press and hold the reset button for at least 3 seconds can restore the MQ-7200M to default factory settings.

Reset Button

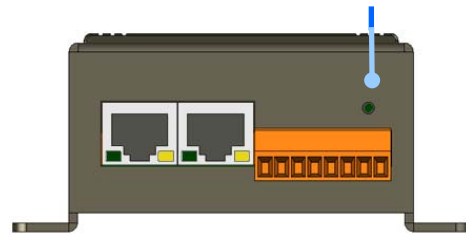

The following configuration will be restored:

Network Configuration

Item	Factory Default Settings
IP Address	192.168.255.1
Gateway	192.168.0.1
Subnet Mask	255.255.0.0
DNS Server	Empty
DHCP	Disabled

Web Configuration

Item	Factory Default Settings
Module Name	Depends on the name of the module
Page Header Information (First line)	ICP DAS
Page Header Information (Second line)	http://www.icpdas.com
Web Server Port	80
Modbus TCP Port	502

I/O Settings

The information displayed on the settings page varies depending on the model number.

Digital Output

Item	Factory Default Settings
Power-on Value	OFF
Safe Value	OFF

Troubleshooting

A number of common problems are easy to diagnose and fix if you know the cause.

Symptom/Problem	Possible cause	Solution
The Run LED doesn't light	Internal power has failed	Return the module for repair.
The Run LED indicator is ON (light), but not flashing.	The module has possibly crashed.	Reboot the module
Cannot communicate via the Ethernet port, but the MQ-7200M is still operating.	The IP/Mask/Gateway address isn't within the IP address range of the LAN.	Change the IP/Mask/Gateway address to match the LAN, or ask the MIS administrator for assistance.
	There are more than 30 TCP/IP connections.	Reboot the module.
Able to explore the web page through using a web browser, but the connection to broker can not be established.	Port 1883 has been restricted by the firewall.	Consult your MIS administrator for assistance.

Revision History

The table below shows the revision history.

Revision	Date	Description
1.0.0	Aug, 2016	Initial issue