

# LE-37R

---

3.5 inch Motherboard

**User's Manual**

**Edition 1.2**

**2023/01/31**

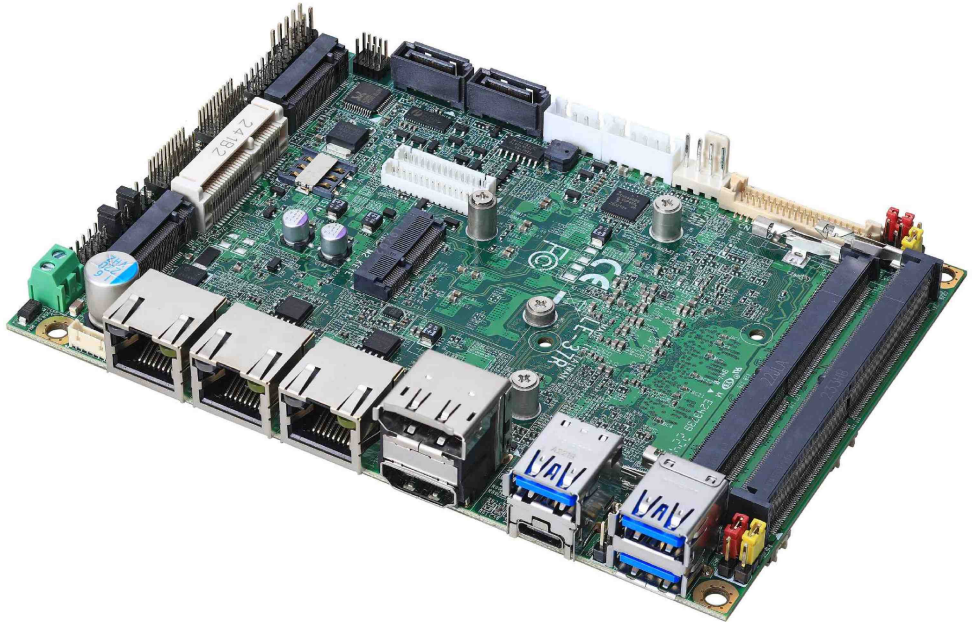

## Copyright

Copyright 2022, all rights reserved. This document is copyrighted and all rights are reserved. The information in this document is subject to change without prior notice to make improvements to the products.

This document contains proprietary information and protected by copyright. No part of this document may be reproduced, copied, or translated in any form or any means without prior written permission of the manufacturer.

All trademarks and/or registered trademarks contains in this document are property of their respective owners.

## Disclaimer

The company shall not be liable for any incidental or consequential damages resulting from the performance or use of this product.

The company does not issue a warranty of any kind, express or implied, including without limitation implied warranties of merchantability or fitness for a particular purpose.

The company has the right to revise the manual or include changes in the specifications of the product described within it at any time without notice and without obligation to notify any person of such revision or changes.

## Trademark

All trademarks are the property of their respective holders.

---

Any questions please visit our website at <http://www.commell.com.tw>

## Packing List:

Please check the package content before you starting using the board.



1 x LE-37R 3.5 inch Miniboard  
(Include cooler fan)



1 x SATA Power Cable  
(OALSATA15-2PJ / 1040613)



1 x Dual COM cable  
(OALES-BKU2NB / 1040090)



1 x Audio cable  
(OALPJ-HDUNB / 1040123)



2 x SATA Cable  
(OALSATA3-L) / (1040529)



1 x Driver CD  
(Including User's Manual)



1 xDC Input Power Cable  
(OALDC-B / 1040513)



1 x HDMI Cable  
(OALHDMI2M-L15/ 1040690)  
**(Optional)**

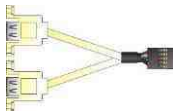

1 x USB2.0 cable  
(OALUSBA-3 / 1040173)  
**(Optional)**

## Index

<b>Chapter 1 &lt;Introduction&gt;</b> .....	4
1.1 <Product Overview>.....	4
1.2 <Product Specification> .....	5
1.3 <Block Diagram>.....	6
<b>Chapter 2 &lt;Hardware setup&gt;</b> .....	7
2.1 <Connector Location and Reference> .....	7
2.1.1 <Internal connectors list> .....	8
2.1.2 <External connectors list> .....	8
2.2 <Memory Setup>.....	9
2.3 <Jumper Location and Reference> .....	10
2.3.1 <Jumper list> .....	10
2.3.2 <Clear CMOS and Power on type selection>.....	11
2.4 <I/O interface> .....	12
2.4.1 <Serial ATA interface> .....	12
2.4.2 <Ethernet interface>.....	13
2.4.3 <Display interface> .....	13
2.4.4 <Serial Port interface> .....	16
2.4.5 <USB interface & Type C > .....	18
2.4.6 <Audio interface> .....	19
2.4.7 <Expansion slot>.....	20
2.4.8 <Front panel switch and indicator> .....	21
2.4.9 <GPIO and Other interface> .....	22
2.5 <Power supply> .....	24
2.5.1 <Power input> .....	24
2.5.2 <Power Output> .....	24
<b>Appendix A &lt;Flash BIOS&gt;</b> .....	25
<b>Appendix B &lt;LCD Panel Type select&gt;</b> .....	26
<b>Appendix C &lt;Programmable Watch Dog Timer&gt;</b> .....	27
<b>Appendix D &lt;Hardware Monitor&gt;</b> .....	29
<b>Appendix E &lt;Programmable GPIO&gt;</b> .....	30
<b>Contact information</b> .....	31

# Chapter 1 <Introduction>

## 1.1 <Product Overview>

**LE-37R** is a 3.5" Motherboard which supports Alder Lake/12th Gen P Processors, integrated Intel® Xe Graphics, DDR5 memory, Realtek High Definition Audio, Intel Gigabit LAN, USB3.2 Gen2, SATA3, Type C with AHCI function for a system.

### **New feature for Alder Lake**

Alder Lake/12th Gen Processors are based on the 7nm SuperFin process, and offer long-life availability. i7-1270PE processor with 4 P-cores and 8 E-cores. P-cores can help you handle heavy tasks, and E-cores run background tasks efficiently to save power.

### **All in One multimedia solution**

The board provides high performance onboard graphics, and supports Type C (Alt mode), HDMI, and High Definition Audio, to meet the very requirement of the multimedia application.

### **Alder Lake support Windows 10 version 21H2 64bit and Linux 5.18**

Intel recommends using Windows 10 version 21H2 64bit. It may lose some drivers if you use other Windows version.

## 1.2 <Product Specification>

### System

Processor	Intel® Alder Lake P Processor FCBGA1744 package
Memory	2 x DDR5 SO-DIMM up to 4800 MHz 64GB, Support Non-ECC, unbuffered memory
Watchdog Timer	Generates a system reset with internal timer for 1min/s ~ 255min/s
Real Time Clock	Chipset integrated RTC with onboard lithium battery
Expansion	1 x MiniPCIe with SIM Slot (support mSATA) <b>(Note3)</b> 1 x M.2 (Key E 2230) for Wi-Fi and Bluetooth 2 x M.2 (Key M 2280) support PCIe Gen4 for NVMe

### Graphics

Chipset	Intel® Iris® Xe Graphics (i7, i5) Intel® UHD Graphics (i3, Celeron 7305E)
Display Interface	1 x LVDS <b>(Note1)</b> , 1 x DisplayPort <b>(Note2)</b> , 1 x HDMI, 2 x HDMI / DVI, 1 x Type-C (DP Alt. Mode)

### LAN

Chip	1 x Intel® I219-LM Gigabit PHY LAN (supports Intel® AMT 16) 2 x Intel® I226-LM Gigabit LAN (up to 2.5GbE)
------	--

### I/O

Serial ATA	2 x SATA3 <b>(Note3)</b>
Audio	Realtek ALC888S HD Audio
Internal I/O	2 x SATA3, 2 x USB2.0, 2 x HDMI / DVI, 2 x RS232, 2 x RS232/485/422 1 x LVDS, 1 x LCD inverter connector, 1 x GPIO, 1 x Audio, 1 x Audio Amplifier, 1 x SMBus
Rear I/O	1 x DisplayPort <b>(Note2)</b> , 1 x HDMI, 1 x Type-C (DP Alt. Mode), 3 x USB3.2 Gen2, 3 x LAN

### Mechanical & Environmental

Power Requirement	DC input 9~35V
Size	146mm x 101mm (L x W)
Temperature	Operating within 0°C~60°C (32°F~140°F) Storage within -20°C~80°C (-4°F~176°F)
Relative Humidity	10%~90%, non-condensing

**Note1:** Onboard 18/24-bit single/dual channel +3.3V/ +5V/ +12V LVDS.

**Note2:** Change pin header to support ADP-3355 or ADP-3460, please contact with our sales for OEM version.

**Note3:** SATA2 cannot use when Mini\_card change to mSATA.

**Note4:** Intel Iris Xe Graphics has to install two memory cards.

## 1.3 <Block Diagram>

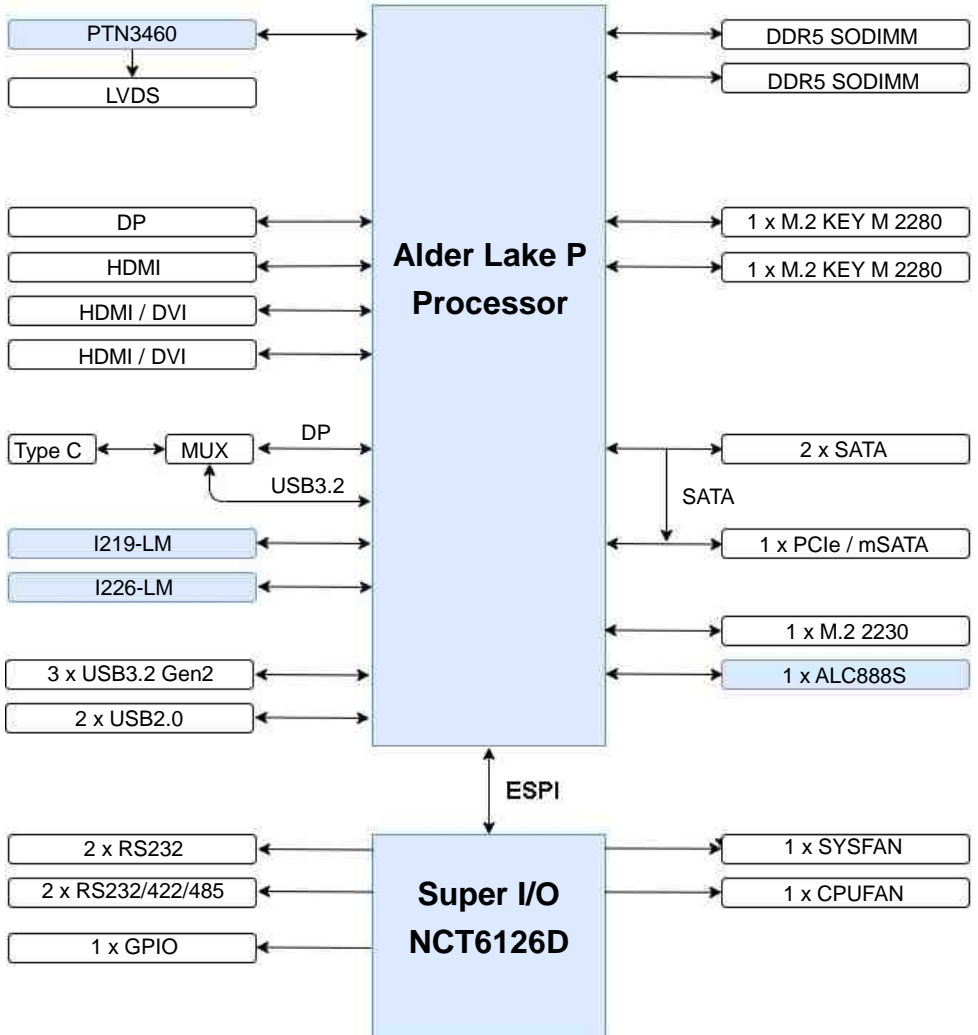

# Chapter 2 <Hardware setup>

## 2.1 <Connector Location and Reference>

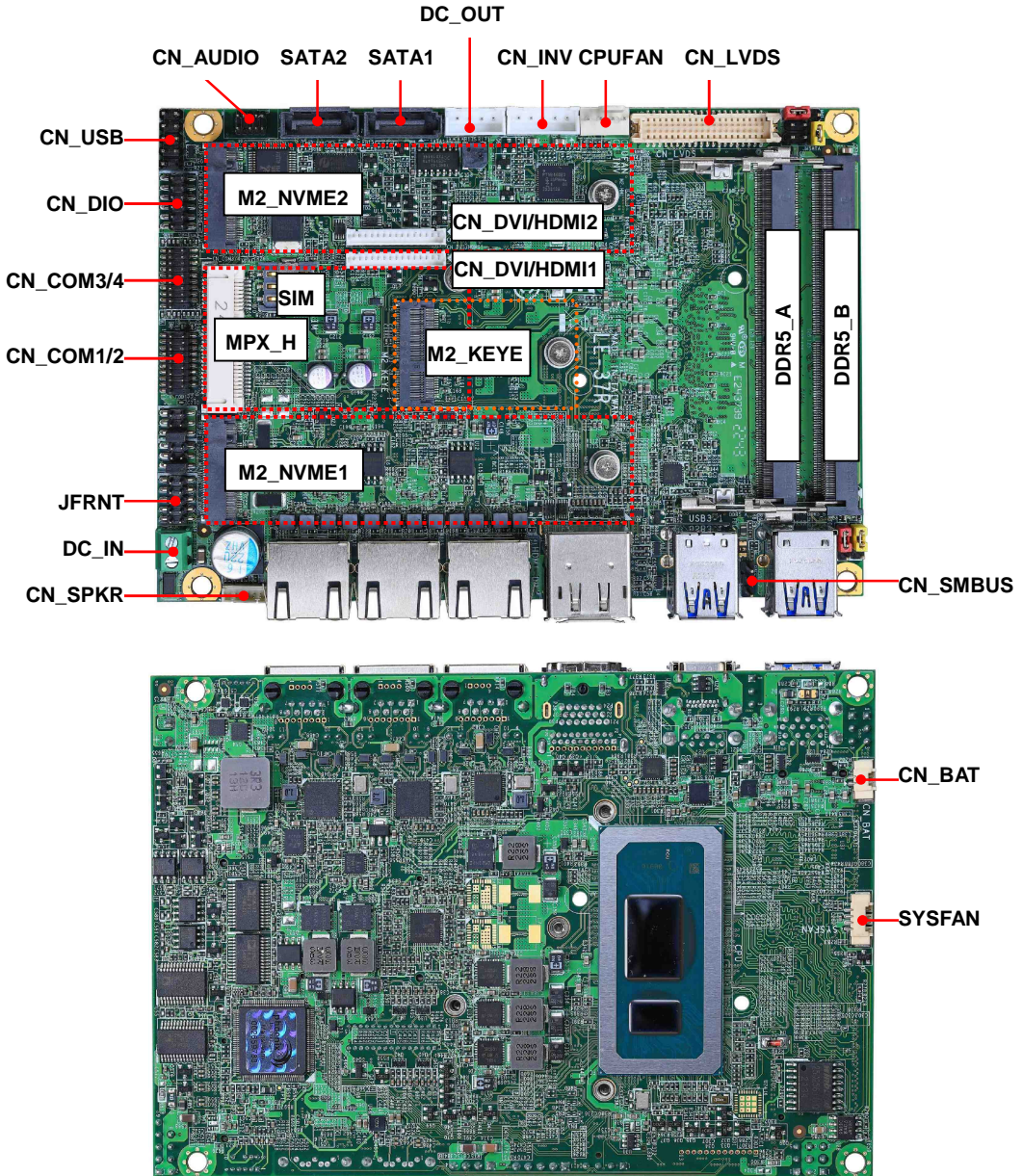



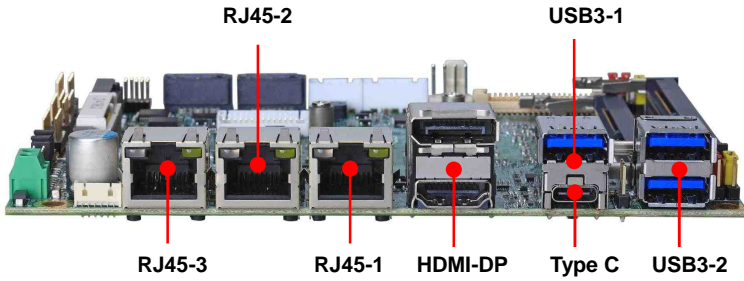

## 2.1.1 <Internal connectors list>

Connector	Function
DDR5_A/B	262-pin DDR5 SO-DIMM slot
SATA1/2	7-pin SATA3 connector
CN_AUDIO	5 x 2-pin audio pin header
CN_LVDS	20 x 2-pin LVDS connector
CN_INV	5-pin LCD inverter connector
CN_SMBUS	3-pin SMBus connector
CN_COM 1/2	20-pin RS232/RS422/RS485 connector
CN_COM 3/4	20-pin RS232 connector
CN_USB	5 x 2-pin USB2.0 pin header
CN_DIO	6 x 2-pin digital I/O connector
CN_BAT	2-pin Battery connector
CN_SPKR	6-pin Speaker connector
CPUFAN	4-pin CPU fan connector
SYSFAN	4-pin system fan connector
JFRNT	10-pin front panel switch/indicator connector
MPX_H	52-pin MiniPCIe card slot
M2_KEYE	75-pin M.2 Key E slot
M2_NVME1/2	75-pin M.2 2280 Key M slot support PCIe Gen4
DC_IN	2-pin power input Terminal Block
DC_OUT	4-pin SATA Power connector
SIM	6-pin SIM socket

## 2.1.2 <External connectors list>

Connector	Function
HDMI-DP	DisplayPort and HDMI dual layer connector
USB3-1	1 x USB3.2 Gen2 connector
USB3-2	2 x USB3.2 Gen2 connector
RJ45-1	RJ45 connector (I219-LM)
RJ45-2/3	RJ45 connector (I226-LM)
Type C	Support USB3.2 gen2 or DP

## 2.2 <Memory Setup>

LE-37R has 262-pin DDR5 SODIMM support up to 64GB of memory capacity and 1.1 Voltage. Only Non-ECC memory is supported.

**In the process, the board must be powered off.**

1. Put the memory tilt into the slot. Note the Memory notch key aligned slot key.
2. Then press down till lock into the mounting notch.

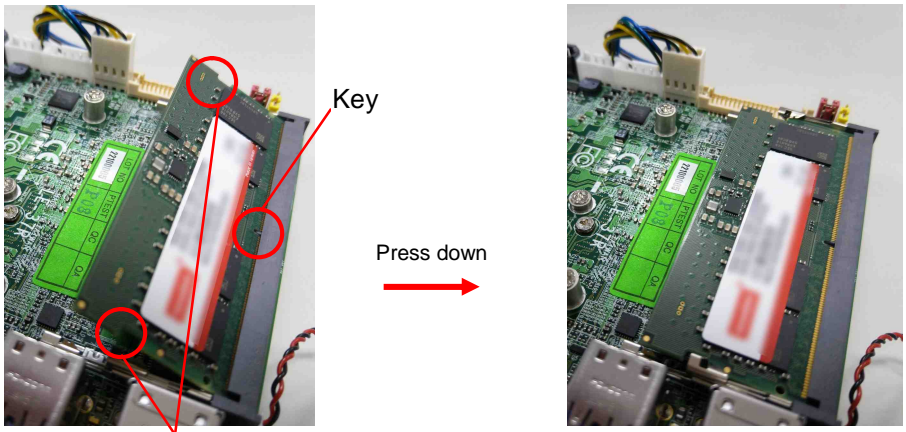

Mounting notch

3. To remove the memory, push outward on both sides of the latch.

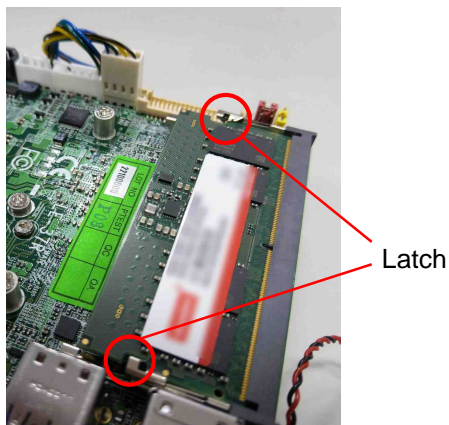

## 2.3 <Jumper Location and Reference>

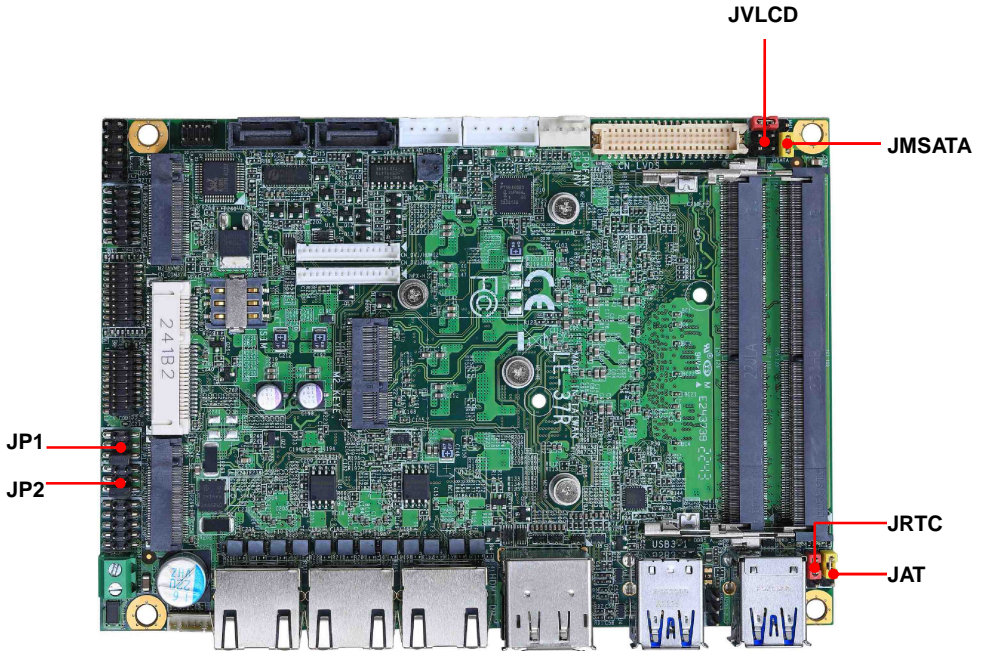

### 2.3.1 <Jumper list>

Jumper	Function
JAT	Power mode select
JRTC	CMOS Normal/Clear Setting
JVLCD	Panel Voltage Setting
JMSATA	MiniCard mSATA Setting
JP1	COM1 Voltage Setting (For Pin 9)
JP2	COM2 Voltage Setting (For Pin 9)

### 2.3.2 <Clear CMOS and Power on type selection>

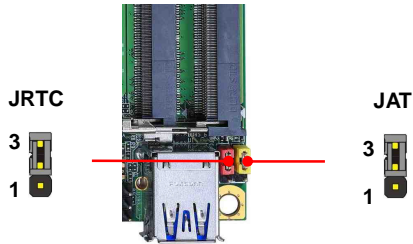

**JAT:** AT/ATX mode select jumper

Jumper settings	Function
1-2	AT mode
2-3	ATX mode (Default)

**JRTC:** Clear CMOS data jumper

Jumper settings	Function
1-2	Clear CMOS
2-3	Normal (Default)

## 2.4 <I/O interface>

### 2.4.1 <Serial ATA interface>

SATA 1/2 : SATA3 7-pin connector

Pin	Signal
1	GND
2	TX+
3	TX-
4	GND
5	RX-
6	RX+
7	GND

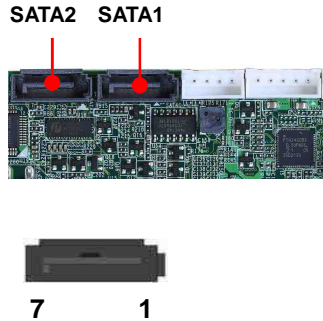

### 2.4.2 <Ethernet interface>

The board provides I219-LM Gigabit Ethernet which supports WOL on rear I/O. It supports Intel® AMT 16.0 feature on I219-LM.

(Note that the CPU must support vPro technology.)

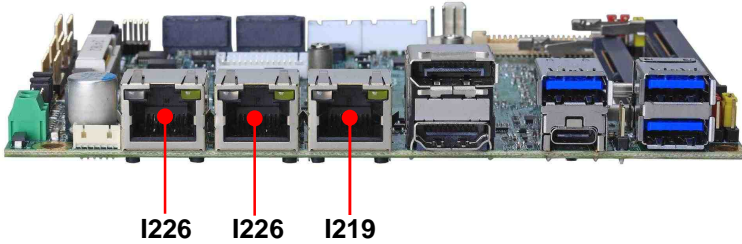

### 2.4.3 <Display interface>

Based on the 12th Gen CPU with built-in Intel® Xe Graphics, the DisplayPort resolution up to 3840x2160 @ 60Hz or 4096x2304 @ 60Hz, the HDMI up to 4096x2304 @ 24Hz and LVDS up to 1920x1200 @ 60Hz supports single bus or dual bus LVDS signaling with color depths of 18 bits or 24 bits. About select LCD Panel Type in BIOS, please refer [Appendix B](#). The built-in Iris® Xe Graphics support Quad display function with clone mode and extended mode.

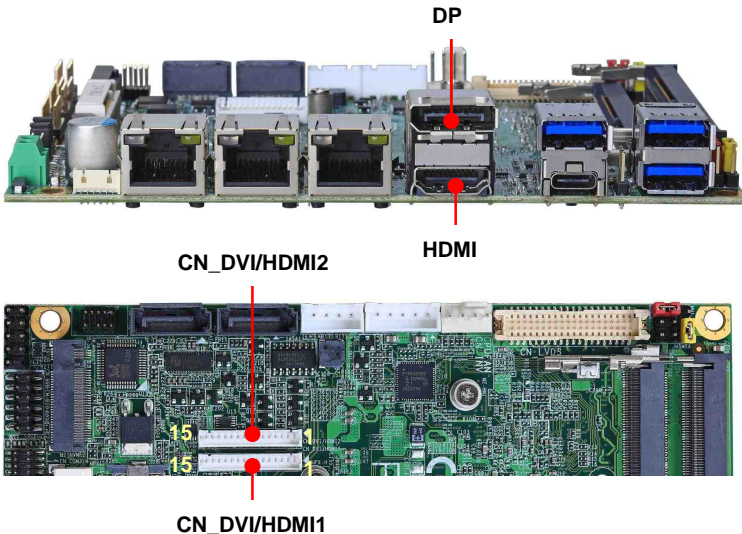

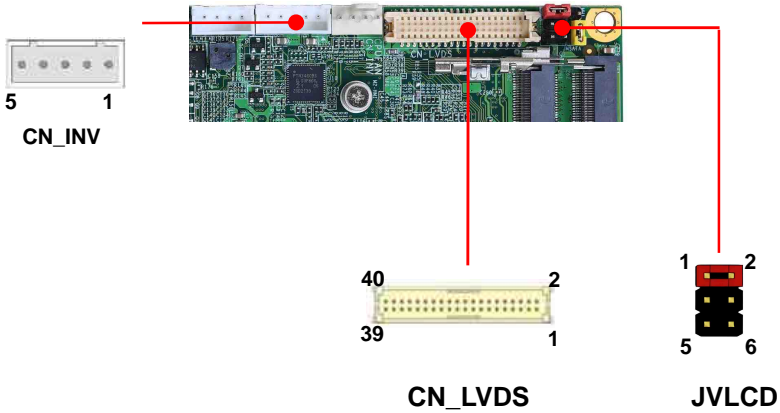

**CN\_LVDS:** LVDS 40-pin connector (Model: HIROSE DF13-40DP-1.25V compatible)

Pin	Signal	Pin	Signal
2	Set by JVLCD	1	Set by JVLCD
4	Detect (Active low)	3	GND
6	A_LVDS_0-	5	B_LVDS_0-
8	A_LVDS_0+	7	B_LVDS_0+
10	GND	9	GND
12	A_LVDS_1-	11	B_LVDS_1-
14	A_LVDS_1+	13	B_LVDS_1+
16	GND	15	GND
18	A_LVDS_2-	17	B_LVDS_2-
20	A_LVDS_2+	19	B_LVDS_2+
22	GND	21	GND
24	A_LVDS_CLK-	23	B_LVDS_3-
26	A_LVDS_CLK+	25	B_LVDS_3+
28	GND	27	GND
30	A_LVDS_3-	29	B_LVDS_CLK-
32	A_LVDS_3+	31	B_LVDS_CLK+
34	GND	33	GND
36	LVDS_DDCSCL	35	NC
38	LVDS_DDCSDA	37	NC
40	NC	39	NC

**Pin4 only need to be connected to GND**

**CN\_INV:** LVDS 5-pin Backlight power connector

Pin	Signal
1	12V
2	Backlight Control
3	5V
4	GND
5	Enable Backlight

**JVLCD:** LVDS panel power select jumper

Jumper settings	Function
1-2	3.3V (Default)
3-4	5V
5-6	12V

**CN\_DVI/HDMI1/2 :** DVI or HDMI connector

Jumper settings	Function	Jumper settings	Function
1	TMDS Data2+	9	GND
2	TMDS Data2-	10	TMDS Clock+
3	GND	11	TMDS Clock-
4	TMDS Data1+	12	SCL
5	TMDS Data1-	13	SDA
6	GND	14	+5 V Power
7	TMDS Data0+	15	HPD
8	TMDS Data0-		



## 2.4.4 <Serial Port interface>

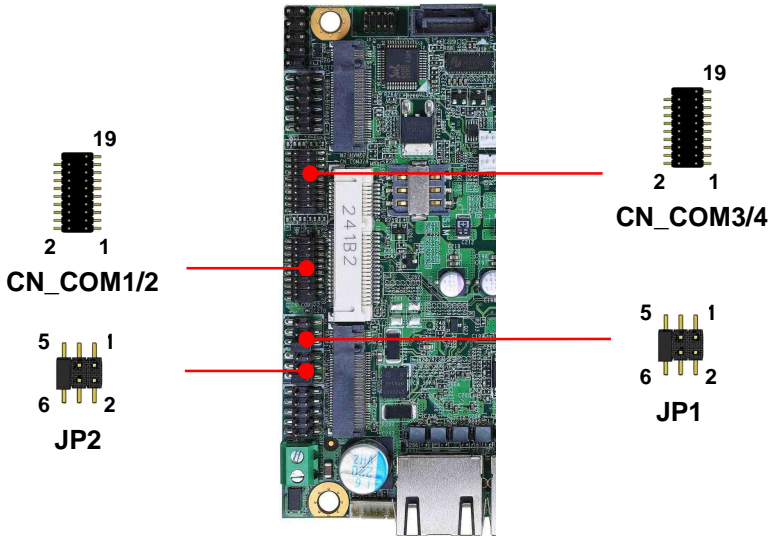

**CN\_COM1/2:** RS232/422/485 20-pin header (Pitch 2.54 x 1.27mm)

Pin	Signal	Pin	Signal
1	DCD1/ 422TX-/ 485-	2	RXD1/ 422TX+/ 485+
3	TXD1	4	DTR1
5	GND	6	DSR1/ 422RX+
7	RTS1	8	CTS1/ 422RX-
9	Set by JP1	10	NC
11	DCD2/ 422TX-/ 485-	12	RXD2/ 422TX+/ 485+
13	TXD2	14	DTR2
15	GND	16	DSR2/ 422RX+
17	RTS2	18	CTS2/ 422RX-
19	Set by JP2	20	Key

**CN\_COM1/2 RS-232/422/485 can set by BIOS.**

You can find the setting from

Advanced-> Motherboard Advanced menu-> Super IO configuration-> Serial Port configuration->Interface

Serial Port Configuration	Item Specific Help
Serial Port 1: <b>Enabled</b> Base I/O Address: <b>3F8/104</b> Interrupt: <b>IRQ3</b> Clock Source: <b>11.9462 Mhz (115200)</b>	

**If you want to use RS485, please follow below step before connection. .**

COM1 RTX- Data- : short Pin1& Pin8

COM1 RTX+ Data+ : short Pin2& Pin6

COM2 RTX- Data-: short Pin1& Pin8

COM2 RTX+ Data+: short Pin2& Pin6

**JP1, JP2:** COM1, COM2 pin-9 setting

Jumper settings	Function
1-2	5V
3-4	12V
5-6	RI (Default)

**Effective patterns of connection:**

**1-2 / 3-4 / 5-6**

**Other may cause damage**

**CN\_COM3/4:** RS232 20-pin header (Pitch 2.54 x 1.27mm)

Pin	Signal	Pin	Signal
1	DCD1	2	RXD1
3	TXD1	4	DTR1
5	GND	6	DSR1
7	RTS1	8	CTS1
9	RI1	10	NC
11	DCD2	12	RXD2
13	TXD2	14	DTR2
15	GND	16	DSR2
17	RTS2	18	CTS2
19	RI2	20	Key

## 2.4.5 <USB interface & Type C >

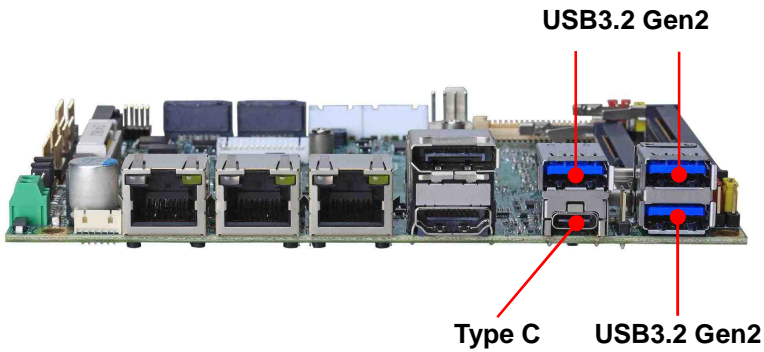

**CN\_USB:** USB2.0 10-pin header (Pitch 2.54 mm)

Pin	Signal	Pin	Signal
1	5VSB	2	5VSB
3	DATA0-	4	DATA1-
5	DATA0+	6	DATA1+
7	GND	8	GND
9	GND	10	Key

**Type C** supports USB 3.1 gen2 and DP Alt. mode, and provides 5V at 3A.

## 2.4.6 <Audio interface>

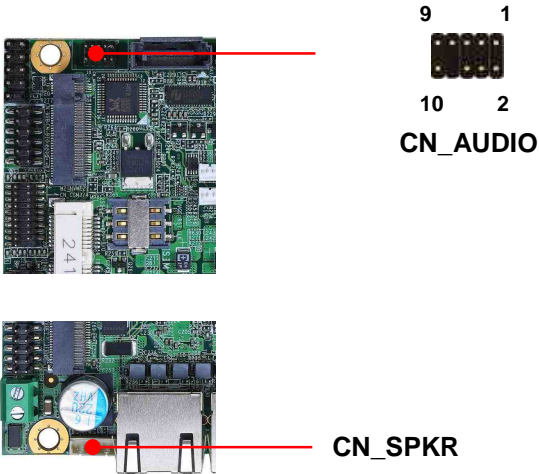

**CN\_AUDIO:** Front panel audio 10-pin header (Pitch 2.54\*1.27mm)

Pin	Signal	Pin	Signal
1	MIC_L	2	GND
3	MIC_R	4	NC
5	FP_OUT_R	6	MIC_DETECT
7	SENSE	8	Key
9	FP_OUT_L	10	FP_OUT_DETECT

**CN\_SPKR:** 6-pin Two channel Audio Amplifier

Pin	Signal	Pin	Signal
1	FP_OUT_L_P	2	FP_OUT_L_N
3	JD_Front	4	GND
5	FP_OUT_R_P	6	FP_OUT_R_N

## 2.4.7 <Expansion slot>

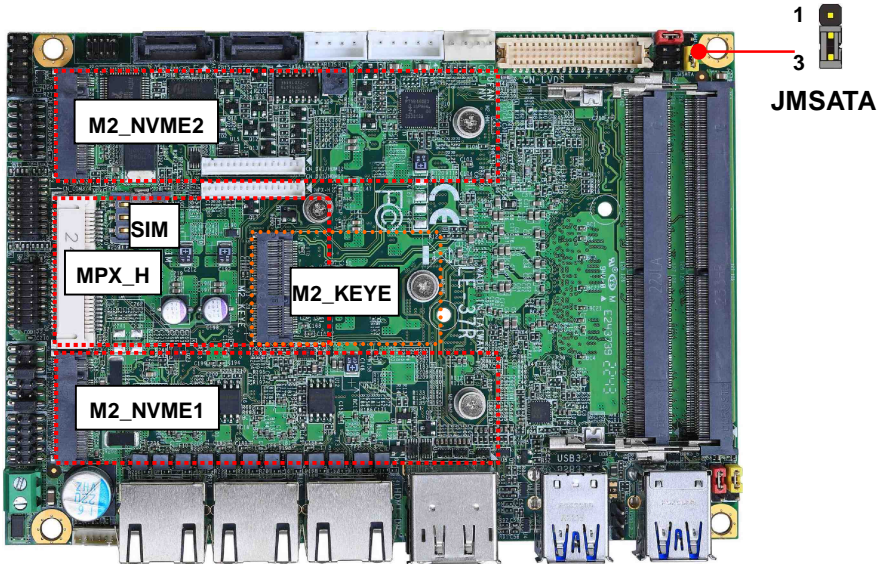

MPX\_H support mSATA by JMSATA, and connect SIM card  
 M.2\_NVME1 /2 support PCIe Gen4  
 M2\_KEYE support WI-FI and Bluetooth Module

**JMSATA:** Setting MPX\_H to support PCIe/mSATA

Jumper settings	Function
1-2	Support mSATA
2-3	Normal operation (Default)

## 2.4.8 <Front panel switch and indicator>

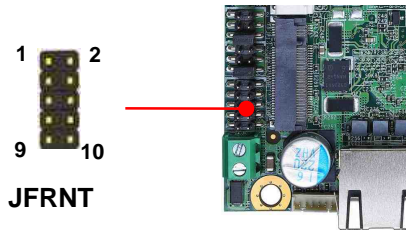

**JFRNT:** Front panel switch and indicator 10-pin header

Pin	Signal	Pin	Signal
1	Power_ON-	2	Power_ON+
3	Speaker-	4	Speaker+
5	HDD_LED-	6	HDD_LED+
7	Power_LED-	8	Power_LED+
9	Reset+	10	Reset-

### 2.4.9 <GPIO and Other interface>

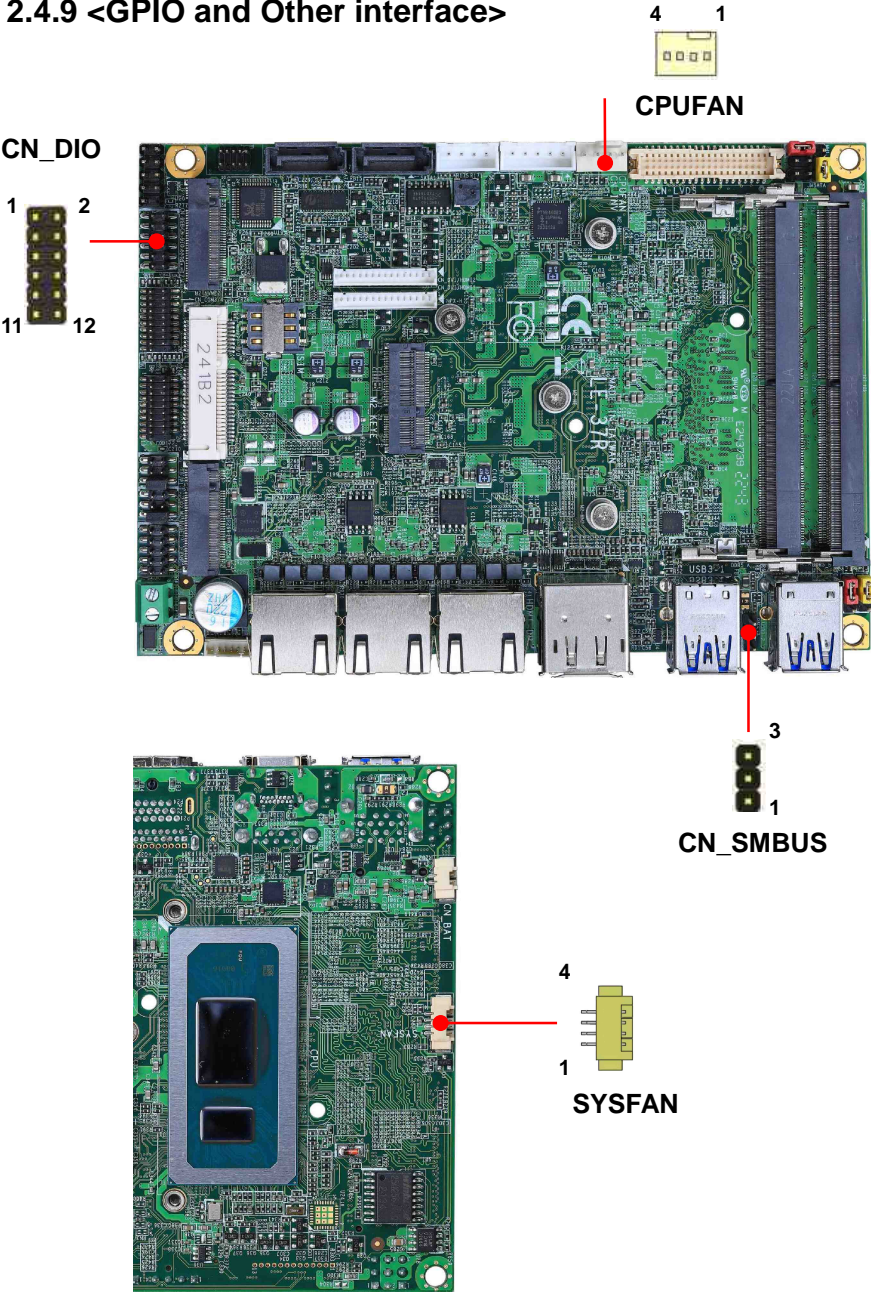

When using GPIO function, please note:

As Output: **Open-drain**, most applications need use an external pull up resistor.

(If not may cause damage)

As Input: **TTL-level**.

### GPIO DC characteristics (open drain mode)

Parameter	SYM	MIN	TYP	MAX	UNIT	Conditions
Input Low Voltage	V <sub>IL</sub>			0.8	V	
Input High Voltage	V <sub>IH</sub>	2.0			V	
Output Low Voltage	V <sub>OL</sub>			0.4	V	I <sub>OL</sub> =12mA
Input High Leakage	I <sub>LIH</sub>			+10	μA	V <sub>IN</sub> =3.3V
Input Low Leakage	I <sub>LIL</sub>			-10	μA	V <sub>IN</sub> =0V

Please refer to [Appendix E](#) to program the configuration register

### CN\_DIO: GPIO 12-pin header (Pitch 2.00mm)

Pin	Signal	Pin	Signal
1	GND	2	GND
3	GP40	4	GP44
5	GP41	6	GP45
7	GP42	8	GP46
9	GP43	10	GP47
11	5V	12	12V

### CN\_SMBUS: SMBus 5-pin connector (Pitch 2.54mm)

Pin	1	2	3
Signal	SMBCLK	GND	SMBDAT

### CPUFAN: CPU cooler fan 4-pin connector

Pin	1	2	3	4
Signal	GND	12V	Sensor	Control

### SYSFAN: System cooler fan 4-pin connector

Pin	1	2	3	4
Signal	GND	12V	Sensor	Control



## 2.5 <Power supply>

### 2.5.1 <Power input>

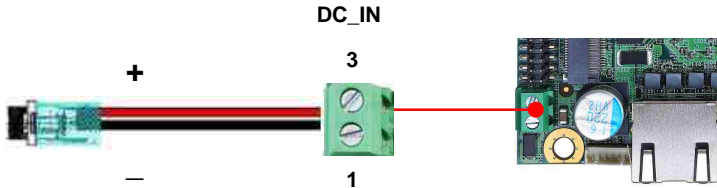

DC\_IN: Terminal block 2-pin power connector

Pin	Signal	Pin	Signal
1	GND	3	DC input 9~35V

### 2.5.2 <Power Output>

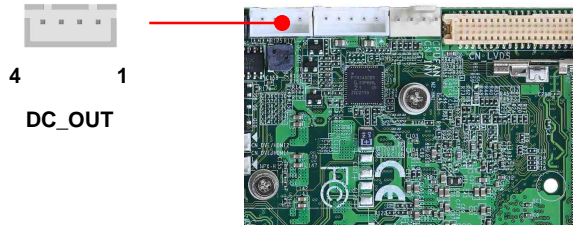

DC\_OUT: SATA power 4-pin connector

Pin	Signal
1	12V
2	GND
3	GND
4	5V

# Appendix A <Flash BIOS>

## A.1 <Flash tool>

The board is based on Phoenix BIOS and can be updated easily by the BIOS auto flash tool. You can download the tool online at the address below:

### [FPT Tool](#)

The tool's file name is "FPT.exe", it's the utility that can write the data into the BIOS flash chip and update the BIOS.

## A.2 <Flash BIOS process>

- 1.Extract the zip file(re-flash tool and BIOS file) to root of the USB flash drive.
- 2.Insert your USB flash drive in USB port of the board and power on the system.
- 3.Press F5 in the Phoenix Logo screen
- 4.Click the Internal Shell, then input the "fs0:" command to switch to the root of the USB flash drive.
5. Type the " fpt -savemac -f xxx.bin" command to start flash BIOS processes. ( xxx.bin means the BIOS file that you want to update)
6. When it finished all update processes, restart the system.

```

UEFI Interactive Shell v2.2
EDK II
UEFI v2.70 (Phoenix Technologies Ltd., 0x12345678)
Mapping table
FS0: Alias(s) :HD0p0b::BLK1:
    PciRoot(0x0)/Pci(0x14,0x0)/USB(0xF,0x0)/HD(1,GPT,C08627CA-4DD0-443C-B57C-965C9707287B,0x800,0x3947303)
FS1: Alias(s) :HD1b::BLK3:
    PciRoot(0x0)/Pci(0xE,0x0)/NvMe(0x1,03-12-04-00-00-3E-69-24)/HD(1,GPT,FC7D92D0-5901-4BB4-B062-417B361790AC,0x800,0x3200
0)
BLK0: Alias(s) :
    PciRoot(0x0)/Pci(0x14,0x0)/USB(0xF,0x0)
BLK2: Alias(s) :
    PciRoot(0x0)/Pci(0xE,0x0)/NvMe(0x1,03-12-04-00-00-3E-69-24)
BLK7: Alias(s) :
    PciRoot(0x0)/Pci(0xE,0x0)/NvMe(0x2,04-12-04-00-00-3E-69-24)
BLK4: Alias(s) :
    PciRoot(0x0)/Pci(0xE,0x0)/NvMe(0x1,03-12-04-00-00-3E-69-24)/HD(2,GPT,03602963-a321-4529-a295-076CF6748D24,0x32800,0x80
00)
BLK5: Alias(s) :
    PciRoot(0x0)/Pci(0xE,0x0)/NvMe(0x1,03-12-04-00-00-3E-69-24)/HD(3,GPT,7043D5DE-C0A7-45EA-825F-BCDD2FDC016D,0x30800,0x1B
DE028D)
BLK6: Alias(s) :
    PciRoot(0x0)/Pci(0xE,0x0)/NvMe(0x1,03-12-04-00-00-3E-69-24)/HD(4,GPT,E12B4413-6F05-402B-A7B3-D48626709E08,0x1BE25000,0
xFE800)
Press ESC in 1 seconds to skip startup.nsh or any other key to continue.
Shell>
Shell> fs0:
FS0:\> fpt -savemac -f 6715_bin_
  
```

## Appendix B <LCD Panel Type select>

According your panel, it needs to select the correct resolution in the BIOS. If there is no fit your panel type, please feedback for us to make OEM model.

Find the setting from

Advanced->Motherboard Advanced menu->LVDS Configuration

**EDID Panel type:** There are 7 resolutions in LCD Panel Type, if your panel is not in the list, please contact [tech@commell.com.tw](mailto:tech@commell.com.tw)

**LVDS Bus:** Select Single / Dual channel

**Panel Color Depth:** Select VESA 24 bit / JEIDA 24 bit / VESA and JEIDA 18 bit

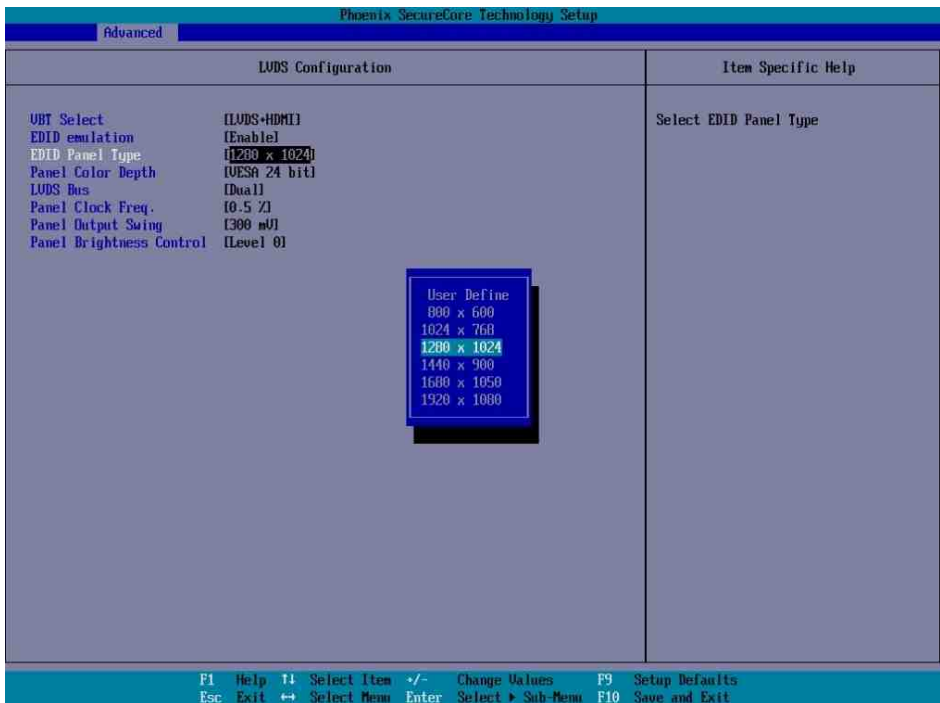

## Appendix C <Programmable Watch Dog Timer>

The watchdog timer makes the system auto-reset while it stops to work for a period. The integrated watchdog timer can be setup as system reset mode by program. You can select Timer setting in the BIOS, after setting the time options, the system will reset according to the period of your selection.

Find the setting from

Advanced → Motherboard Advanced Menu → Power Advanced menu →

Watch dog timer select



**Program sample**

Watchdog timer setup as system reset with 5 second of timeout

```
-o 4E 87      ;enter configuration
-o 4E 87
-o 4E 07
-o 4F 08      ;select Logical Device
-o 4E 30
-o 4F 01      ; activate WDTO# function
-o 4E F0
-o 4F 00      ;set "00" is second mode, set "08" is minute mode
-o 4E F1
-o 4F 05      ;00h: Timeout Disable
                ;01h: Timeout occurs after 1 minute only
                ;02h: Timeout occurs after 2 second/minute
                ;03h: Timeout occurs after 3 second/minute
                ;
                ;FFh: Timeout occurs after 255 second/minute
                (The deviation is approx 1 second.)
```

For further information, please refer to Nuvoton NCT6126D datasheet

## Appendix D <Hardware Monitor>

Find the setting from

Advanced-> Motherboard Advanced menu-> Super IO configuration->

└ Hardware Monitor



The screenshot shows the 'Advanced' BIOS menu with the 'Hardware Monitor' option selected. The 'Hardware Monitor' screen displays the following system status information:

System Temperature	C31 C: 1
PCI Temperature	C31 C: 1
System Fan Speed	10 RPM
CPU Fan Speed	14530 RPM
Battery SV (VBAT)	12.976 V
CPU VCCORE	11.312 V
12V	12.038 V
5V	5.040 V
3.3V	3.312 V

## Appendix E <Programmable GPIO>

The GPIO can be programmed with the MS-DOS debug program using simple IN/OUT commands.

GPIO	0	1	2	3	4	5	6	7
bit	0	1	2	3	4	5	6	7

- o 4E 87 ;enter configuration
- o 4E 87
- o 4E 07
- o 4F 07 ;select Logical Device
- o 4E 30
- o 4F 10 ;activate GPIO function (The board use GPIO4)
- o 4E F0
- o 4F XX ;set "01" GPIO as input, set "00" GPIO as output
- o 4E F1
- o 4F XX ;if set GPIO as output, this register's value can be set "00~ FF"

### Optional

- o 4E F2
- o 4F XX ;set "01", the respective bit are inverted (Both input and output)  
;set "00", the respective bit are normal

For further information, please refer to Nuvoton NCT6126D datasheet

## Contact information

Any advice or comment about our products and service, or anything we can help you please don't hesitate to contact with us. We will do our best to support you for your products, projects and business.

### Taiwan Commate computer Inc.

<b>Address</b>	19F., NO.94, Sec. 1, Xintai 5 <sup>th</sup> Rd., Xizhi Dist., New Taipei City 22102, Taiwan.
<b>TEL</b>	+886-2-26963909
<b>Website</b>	<a href="http://www.commell.com.tw">www.commell.com.tw</a>
<b>E-mail</b>	<a href="mailto:info@commell.com.tw">info@commell.com.tw</a> (General information) <a href="mailto:tech@commell.com.tw">tech@commell.com.tw</a> (Technical Support)

**Commell is a brand name of Taiwan Commate computer Inc.**