

MS-98K9 V2.1

Industrial Computer Board



Copyright and Trademarks Notice

Copyright © Micro-Star Int'l Co., Ltd. All rights reserved. The MSI logo used is a registered trademark of Micro-Star Int'l Co., Ltd. All other marks and names mentioned may be trademarks of their respective owners. No warranty as to accuracy or completeness is expressed or implied. MSI reserves the right to make changes to this document without prior notice.

Revision History

Revision	Date
V2.1	2020/01

Technical Support

If a problem arises with your product and no solution can be obtained from the user's manual, please contact your place of purchase or local distributor. Alternatively, please visit <https://www.msi.com/support/> for further guidance.

Safety Instructions

- Always read the safety instructions carefully.
- Keep this User's Manual for future reference.
- Keep this equipment away from humidity.
- Lay this equipment on a reliable flat surface before setting it up.
- The openings on the enclosure are for air convection hence protects the equipment from overheating. **DO NOT COVER THE OPENINGS.**
- Make sure the voltage of the power source and adjust properly 110/220V before connecting the equipment to the power inlet.
- Place the power cord such a way that people can not step on it. Do not place anything over the power cord.
- Always Unplug the Power Cord before inserting any add-on card or module.
- All cautions and warnings on the equipment should be noted.
- Never pour any liquid into the opening that could damage or cause electrical shock.
- If any of the following situations arises, get the equipment checked by service personnel:
 - ▶ The power cord or plug is damaged.
 - ▶ Liquid has penetrated into the equipment.
 - ▶ The equipment has been exposed to moisture.
 - ▶ The equipment does not work well or you can not get it work according to User's Manual.
 - ▶ The equipment has dropped and damaged.
 - ▶ The equipment has obvious sign of breakage.
- **DO NOT LEAVE THIS EQUIPMENT IN AN ENVIRONMENT UNCONDITIONED, STORAGE TEMPERATURE ABOVE 60°C, IT MAY DAMAGE THE EQUIPMENT.**

Chemical Substances Information

In compliance with chemical substances regulations, such as the EU REACH Regulation (Regulation EC No. 1907/2006 of the European Parliament and the Council), MSI provides the information of chemical substances in products at:

https://www.msi.com/html/popup/csr/evmtprtt_pcm.html

Battery Information



European Union:

Batteries, battery packs, and accumulators should not be disposed of as unsorted household waste. Please use the public collection system to return, recycle, or treat them in compliance with the local regulations.



廢電池請回收

Taiwan:

For better environmental protection, waste batteries should be collected separately for recycling or special disposal.



California, USA:

The button cell battery may contain perchlorate material and requires special handling when recycled or disposed of in California.

For further information please visit:

<https://www.dtsc.ca.gov/hazardouswaste/perchlorate/>

Danger of explosion if battery is incorrectly replaced. Replace only with the same or equivalent type recommended by the manufacturer.

CE Conformity

Hereby, Micro-Star International CO., LTD declares that this device is in compliance with the essential safety requirements and other relevant provisions set out in the European Directive.



FCC-B Radio Frequency Interference Statement



This equipment has been tested and found to comply with the limits for a Class B digital device, pursuant to Part 15 of the FCC Rules. These limits are designed to provide reasonable protection against harmful interference in a residential installation. This equipment generates, uses and can radiate radio frequency energy and, if not installed and used in accordance with the instruction manual, may cause harmful interference to radio communications. However, there is no guarantee that interference will not occur in a particular installation. If this equipment does cause harmful interference to radio or television reception, which can be determined by turning the equipment off and on, the user is encouraged to try to correct the interference by one or more of the measures listed below:

- Reorient or relocate the receiving antenna.
- Increase the separation between the equipment and receiver.
- Connect the equipment into an outlet on a circuit different from that to which the receiver is connected.
- Consult the dealer or an experienced radio/television technician for help.

Notice 1

The changes or modifications not expressly approved by the party responsible for compliance could void the user's authority to operate the equipment.

Notice 2

Shielded interface cables and AC power cord, if any, must be used in order to comply with the emission limits.

This device complies with Part 15 of the FCC Rules. Operation is subject to the following two conditions:

- 1) this device may not cause harmful interference, and
- 2) this device must accept any interference received, including interference that may cause undesired operation.

WEEE Statement

Under the European Union ("EU") Directive on Waste Electrical and Electronic Equipment, Directive 2012/19/EU, products of "electrical and electronic equipment" cannot be discarded as municipal waste anymore and manufacturers of covered electronic equipment will be obligated to take back such products at the end of their useful life.



CONTENTS

Copyright and Trademarks Notice.....	ii
Revision History	ii
Technical Support.....	ii
Safety Instructions.....	iii
Chemical Substances Information	iv
Battery Information	iv
CE Conformity.....	v
FCC-B Radio Frequency Interference Statement	v
WEEE Statement	v
1. Overview.....	1-1
Specifications	1-2
Layout	1-5
2. Hardware Setup	2-1
CPU (Central Processing Unit)	2-3
Memory	2-6
Power Supply.....	2-8
Rear Panel I/O	2-9
Connector.....	2-11
Jumper	2-17
Slot.....	2-18
3. BIOS Setup.....	3-1
Entering Setup	3-2
The Menu Bar	3-4
Main	3-5
Advanced	3-6
Boot.....	3-12
Security	3-13
Chipset	3-21
Power.....	3-22
Save & Exit.....	3-24
Appendix GPIO WDT Programming.....	A-1
Abstract.....	A-2
General Purposed IO	A-3
Watchdog Timer	A-4
SMBus Access	A-5

1 Overview

Thank you for choosing the MS-98K9 V2.1, an excellent industrial computer board.

Based on the innovative Intel® Coffee Lake-S & Coffee Lake Refresh-S Processor, the MS-98K9 V2.1 is engineered to provide reliable performance for a wide variety of industrial applications.

Specifications

Processor

- 8th/9th Gen Intel® Coffee Lake-S & Coffee Lake Refresh-S Xeon®, Core™ i7/i5/i3, Pentium®, Celeron® Processor, Max 95W

PCH

- SKU1: Intel® C246 Express
- SKU2: Intel® Q370 Express

Memory

- 4 * DDR4 UDIMM slots
- SKU1: ECC/non-ECC Dual-Channel DDR4 memory up to 2666MHz
- SKU2: Non-ECC Dual-Channel DDR4 memory up to 2666MHz
- Max 128GB

Network

- LAN1: Intel® I219LM GbE LAN PHY (Supports iAMT 12.0)
- LAN2: Intel® I210-AT GbE LAN
- LAN3: Intel® I210-AT GbE LAN

Storage

- 4 * SATA 6Gb/s ports
 - SATA signal of SATA4 port shared with M.2 M Key slot
 - RAID 0, 1, 5, 10 supported
 - AHCI Mode supported
- 1 * M.2 M Key 2242/2260/2280 slot for SSD
 - With PCIe x4 & SATA signal
 - SATA signal shared with SATA4 port

Audio

- Realtek® ALC887 High Definition Audio codec
- 1 * Line-In jack
- 1 * Line-Out jack
- 1 * Mic-In jack
- 1 * Front audio box header
- 1 * S/PDIF box header

Graphics

- Integrated Intel® HD Graphics (DirectX12 supported)
- 1 * VGA up to 1920 x 1200 @60Hz
- 1 * HDMI 1.4 up to 4096 x 2160 @24Hz
- 2 * DisplayPort 1.2 up to 4096 x 2304 @60Hz
- 3 independent displays
 - DP1+DP2+HDMI
 - DP1+DP2+VGA
 - DP1+HDMI+VGA
 - DP2+HDMI+VGA

Expansion Slots

- 5 * PCIe x16 slots
 - PCIe1, PCIe4: 1 * PCIe x16 or 2 * PCIe x8 signal
 - PCIe2, PCIe3, PCIe5: 3 * PCIe x4 NVMe signal
- 2 * PCI slots

Rear Panel I/O

- 1 * Mouse/Keyboard combo port
- 1 * D-SUB (VGA) port
- 1 * HDMI port
- 2 * DisplayPorts
- 3 * GbE RJ45 ports
- 2 * USB 2.0 ports
- 6 * USB 3.2 Gen 2 ports
- 1 * Line-In jack
- 1 * Line-Out jack
- 1 * Mic-In jack

Internal I/O

- 1 * System power connector
- 1 * CPU power connector
- 1 * CPU fan header
- 3 * System fan headers
- 4 * SATA 6Gb/s ports
- 1 * Vertical USB 2.0 port
- 2 * USB 2.0 box headers (4 ports)
- 1 * Front panel box header
- 1 * TPM box header
- 2 * GPIO box headers
- 1 * Chassis intrusion header
- 1 * Parallel port box header
- 2 * RS232/422/485 serial port box headers
- 4 * RS232 serial port box headers
- 1 * Front audio box header
- 1 * S/PDIF box header
- 1 * SMBus box header
- 1 * I²C box header
- 1 * Clear CMOS jumper
- 1 * AT/ATX jumper
- 6 * COM port power jumpers
- 2 * NVMe LAN jumpers
- 1 * PCIe configure jumper
- 2 * PCI power jumpers

Form Factor

- ATX Size: 305mm (L) x 244mm (W) x 1.6mm (H)

Environment

- Operating Temperature: -10 ~ 60°C
- Storage Temperature: -20 ~ 80°C
- Humidity: 10 ~ 90% RH, non-condensing

Accessories

- 2 * SATA3.0 cables
- 1 * Dual COM port cable with bracket
- 1 * Dual USB 2.0 cable with bracket
- 1 * Parallel port cable with bracket
- 1 * Driver & user manual CD
- 1 * I/O shield

Certification

- CE, FCC Class B, BSMI, RCM, VCCI

OS Support

- Windows 10 IoT Enterprise LTSC/SAC 1809 (64-bit, RS5)
- Linux Kernel 4.14/4.19 (by request)

Layout

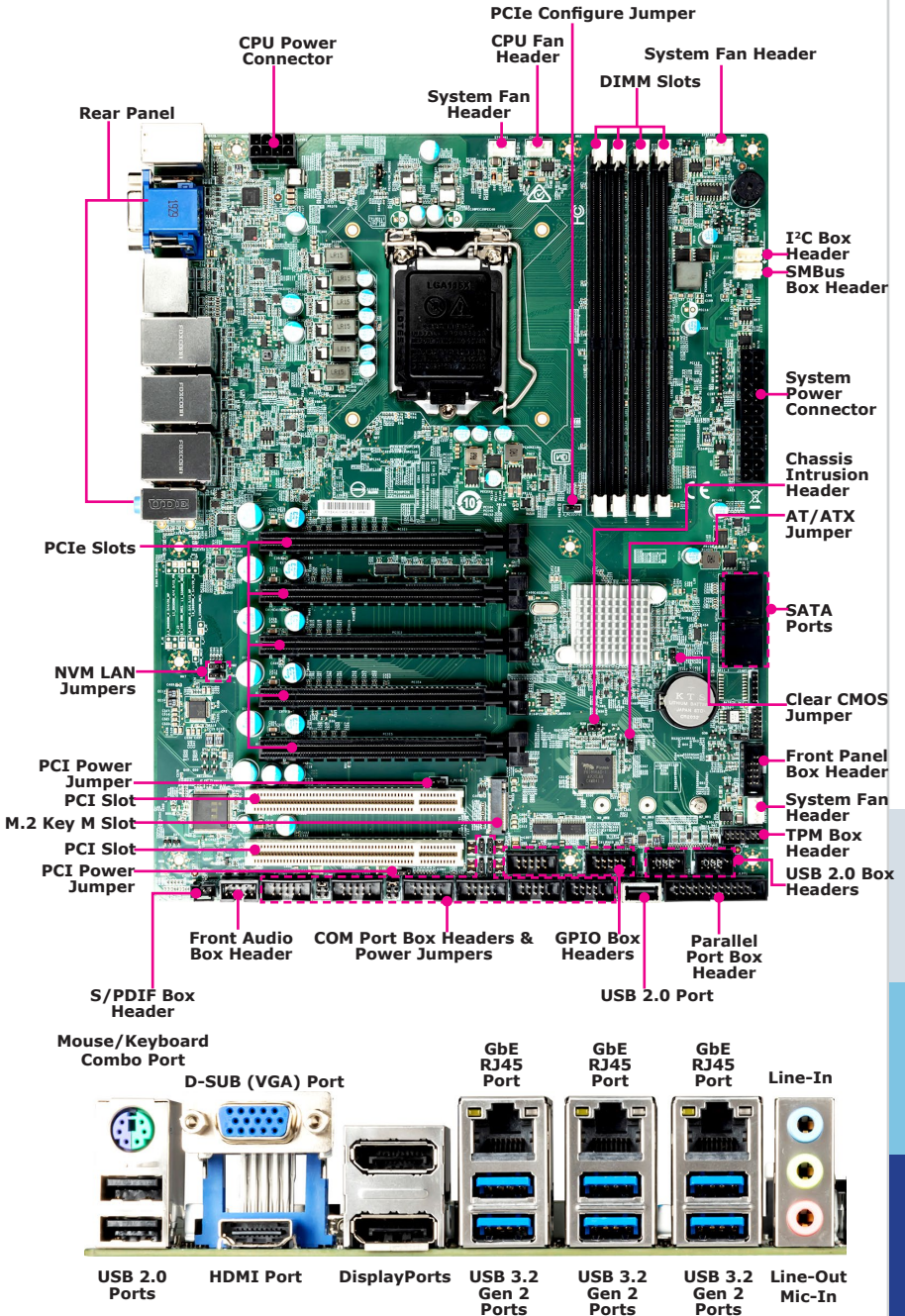

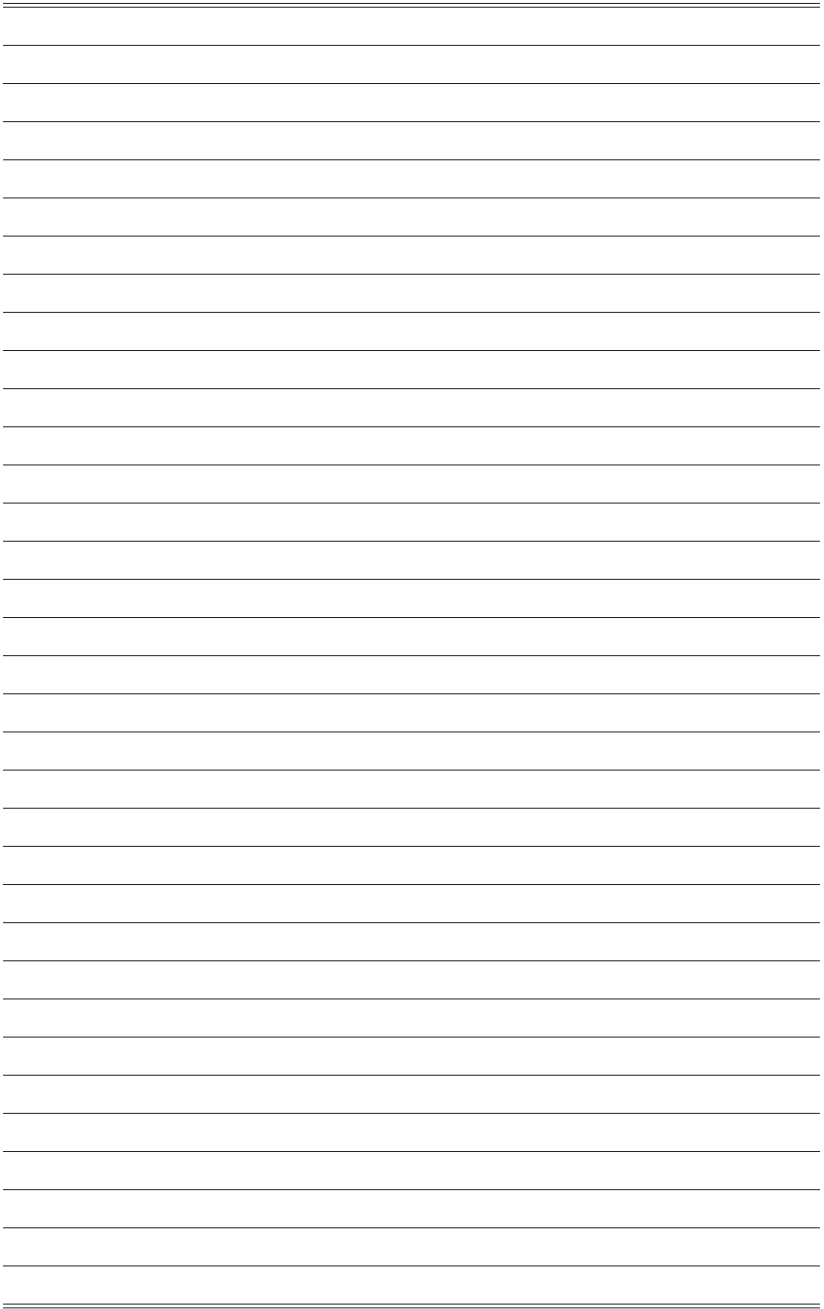

2 Hardware Setup



This chapter provides you with the information about hardware setup procedures. While doing the installation, be careful in holding the components and follow the installation procedures. For some components, if you install in the wrong orientation, the components will not work properly.

Use a grounded wrist strap before handling computer components. Static electricity may damage the components.

Quick Component Guide

CPU (Central Processing Unit)	2-3
Introduction to LGA 115x CPU	2-3
CPU Installation	2-4
Memory	2-6
Dual-Channel Mode	2-6
Recommended Memory Population.....	2-6
Installing Memory Modules	2-7
Power Supply	2-8
System Power Connector: JPWR1	2-8
CPU Power Connector: JPWR2.....	2-8
Rear Panel I/O	2-9
Connector	2-11
CPU/System Fan Header: CPUFAN1, SYSFAN1~3.....	2-11
SMBus Box Header: JSMB1	2-11
I ² C Box Header: JI2C1	2-11
GPI Box Header: JGPIO1	2-12
GPO Box Header: JGPIO2	2-12
Dual Stacked SATA Connector: SATA1_2, SATA3_4.....	2-12
USB 2.0 Box Header: JUSB1, JUSB2,	2-13
USB 2.0 Port: USB1.....	2-13
Front Panel Box Header: JFP1	2-13
Chassis Intrusion Header: JCASE1	2-14
TPM Box Header: JTPM1	2-14
Front Audio Box Header: JAUD1	2-15
S/PDIF Box Header: JSPDIF1	2-15
Parallel Port Box Header: JLPT1	2-15
RS232/422/485 COM Port Box Header: JCOM1, JCOM2.....	2-16
RS232 COM Port Box Header: JCOM3, JCOM4, JCOM5, JCOM6	2-16
Jumper	2-17
Slot	2-18
PCIe (Peripheral Component Interconnect Express) Slot.....	2-18
PCI (Peripheral Component Interconnect) Slot.....	2-18
M2_M1: M.2 Key M 2242/2260/2280 Slot for SSD	2-18

CPU (Central Processing Unit)

When installing the CPU, make sure that you install the cooler to prevent overheating. If you do not have the CPU cooler, consult your dealer before turning on the computer.

Important!

Overheating

Overheating will seriously damage the CPU and system. Always make sure the cooling fan can work properly to protect the CPU from overheating. Make sure that you apply an even layer of thermal paste (or thermal tape) between the CPU and the heatsink to enhance heat dissipation.

Replacing the CPU

While replacing the CPU, always turn off the power supply or unplug the power supply's power cord from the grounded outlet first to ensure the safety of CPU.

Introduction to LGA 115x CPU

The surface of LGA 115x CPU. Remember to apply some thermal paste on it for better heat dispersion.

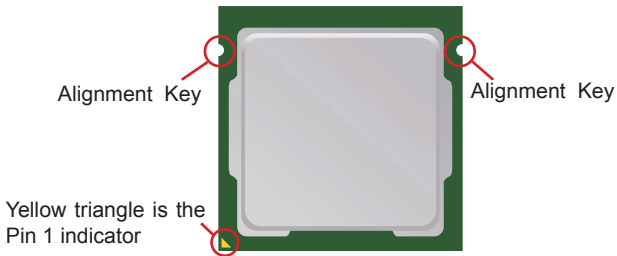

CPU Installation

When you are installing the CPU, **make sure the CPU has a cooler attached on the top to prevent overheating**. Meanwhile, do not forget to apply some thermal paste on CPU before installing the heat sink/cooler fan for better heat dispersion.

1. Open the load lever and remove the plastic cap.
2. Lift the load lever up to fully open position.

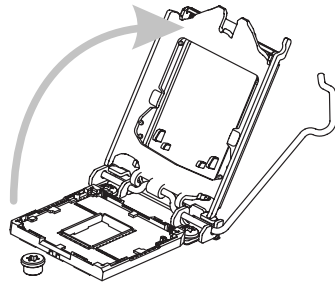
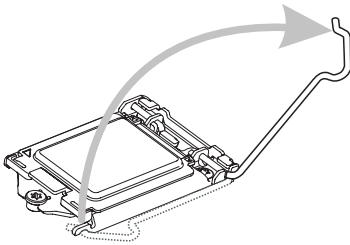

3. After confirming the CPU direction for correct mating, put down the CPU in the socket housing frame. Be sure to grasp on the edge of the CPU base. Note that the alignment keys are matched.
4. Engage the load lever while pressing down lightly onto the load plate.

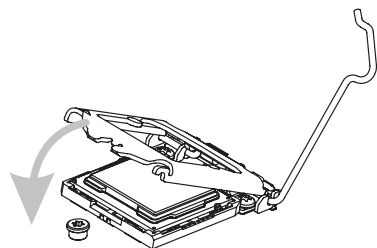
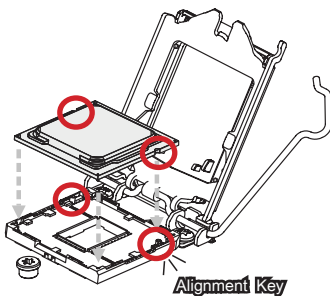

Important

Visually inspect if the CPU is seated well into the socket. If not, take out the CPU with pure vertical motion and reinstall.

5. Secure the load lever with the hook under the retention tab.

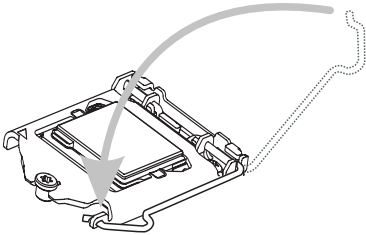

6. Make sure the four hooks are in proper position before you install the cooler. Align the holes on the motherboard with the cooler. Push down the cooler until its four clips get wedged into the holes of the motherboard.

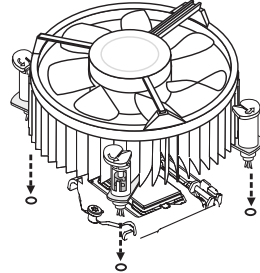

7. Press the four hooks down to fasten the cooler. Turn over the motherboard to confirm that the clip-ends are correctly inserted.

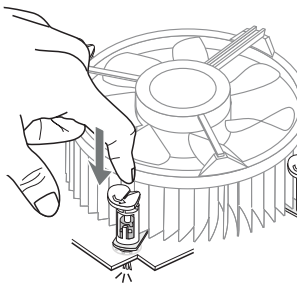

8. Finally, attach the CPU Fan cable to the CPU fan connector on the motherboard.

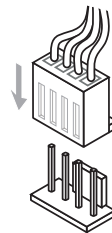

Important

- Confirm if your CPU cooler is firmly installed before turning on your system.
- Do not touch the CPU socket pins to avoid damage.
- Whenever CPU is not installed, always protect your CPU socket pins with the plastic cap covered.
- Please refer to the documentation in the CPU cooler package for more details about the CPU cooler installation.
- Read the CPU status in BIOS.

Memory

Dual-Channel Mode

In Dual-Channel mode, make sure that you install memory modules of the **same type and density** in different channel DIMM slots.

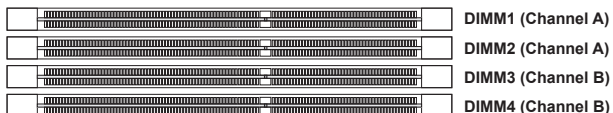

Recommended Memory Population

Number of DIMMs installed	1	2	3	4
DIMM1 (ch A)	V	V	V	V
DIMM2 (ch A)			V	V
DIMM3 (ch B)		V	V	V
DIMM4 (ch B)				V

Important

- "V" indicates a populated DIMM slot.
- Paired memory installation for Max performance.
- Populate the same DIMM type in each channel, specifically: 1. Use the same DIMM size; 2. Use the same number of ranks per DIMM.

Installing Memory Modules

1. The memory module has only one notch on the center and will only fit in the right orientation.
2. Insert the memory module vertically into the DIMM slot. Then push it in until the golden finger on the memory module is deeply inserted in the DIMM slot. The plastic clip at each side of the DIMM slot will automatically close when the memory module is properly seated.
3. Manually check if the memory module has been locked in place by the DIMM slot clips at the sides.

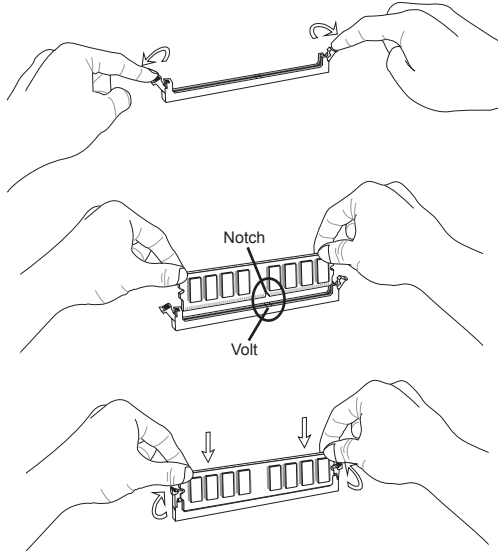

Important

- *You can barely see the golden finger if the memory module is properly inserted in the DIMM slot.*
- *To enable successful system bootup, always insert the memory module into the DIMM1 first.*

Power Supply

System Power Connector: JPWR1

This connector allows you to connect a power supply. To connect to the power supply, make sure the plug of the power supply is inserted in the proper orientation and the pins are aligned. Then push down the power supply firmly into the connector.

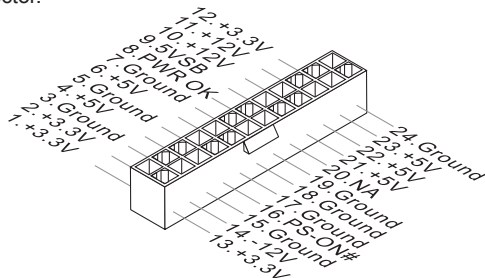

CPU Power Connector: JPWR2

This connector is used to provide power to the CPU.

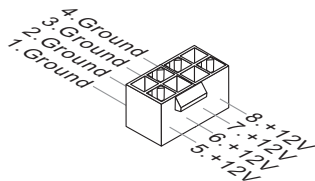

Important

- Make sure that all power connectors are connected to the power supply to ensure stable operation of the motherboard.
- To avoid some issues like system instability, reset and shutdown caused by energy-insufficient power supply, we suggest you should follow [Intel Power Supply Design Guide Rev 1.4 list](#) and Intel Document Number 595284 to choose your power supply unit.

Rear Panel I/O

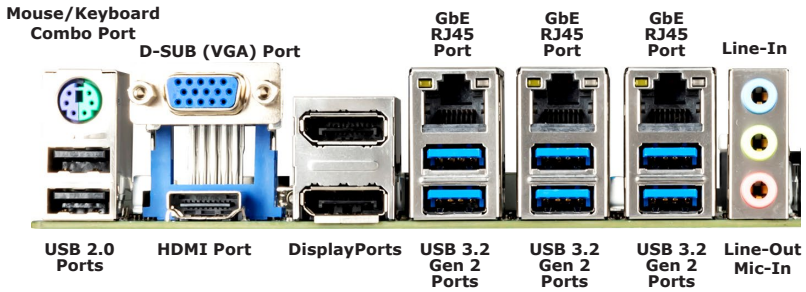

➤ Mouse/Keyboard Combo Port

The standard PS/2® mouse/keyboard DIN connector is for a PS/2® mouse/keyboard.

➤ D-SUB (VGA) Port

The DB15-pin female connector is provided for monitor.

➤ HDMI Port

The High-Definition Multimedia Interface (HDMI) is an all-digital audio/video interface capable of transmitting uncompressed streams. HDMI supports all TV format, including standard, enhanced, or high-definition video, plus multi-channel digital audio on a single cable.

➤ DisplayPort

DisplayPort is a digital display interface standard. This connector is used to connect a monitor with DisplayPort inputs.

➤ GbE RJ45 Port

The standard single RJ45 LAN jack is provided for connection to the Local Area Network (LAN). You can connect a network cable to it.

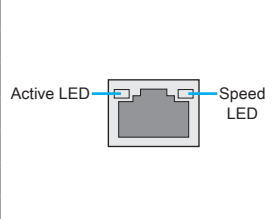
	LED	LED Status	Description
	Active LED	Off	No link
		Yellow	Linked
		Blinking	Data activity
	Speed LED	Off	10 Mbps connection
		Green	100 Mbps connection
Orange		1 Gbps connection	

➤ **USB 2.0 Port**

The USB (Universal Serial Bus) port is for attaching USB devices such as keyboard, mouse, or other USB-compatible devices.

➤ **USB 3.2 Gen 2 Port**

USB 3.2 Gen 2, the SuperSpeed USB 10Gbps, delivers high-speed data transfer for various devices, such as storage devices, hard drives, video cameras, etc.

➤ **Audio Ports**

These audio connectors are used for audio devices. It is easy to differentiate between audio effects according to the color of audio jacks.

- Line-In (Blue) - Line In, is used for external CD player, tapeplayer or other audio devices.
- Line-Out (Green) - Line Out, is a connector for speakers or headphones.
- Mic (Pink) - Mic, is a connector for microphones.

Connector

CPU/System Fan Header: CPUFAN1, SYSFAN1~3

The fan power connectors support system cooling fan with +12V. When connecting the wire to the connectors, always note that the red wire is the positive and should be connected to the +12V; the black wire is Ground and should be connected to GND. If the motherboard has a System Hardware Monitor chipset onboard, you must use a specially designed fan with speed sensor to take advantage of the CPU fan control.

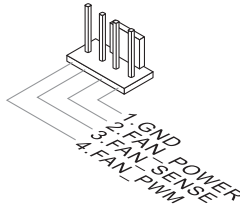

Important

- Please refer to the recommended CPU fans at processor's official website or consult the vendors for proper CPU cooling fan.
- Fan cooler sets with 3- or 4-pin power connector are both available.

SMBus Box Header: JSMB1

This connector is provided for users to connect System Management Bus (SMBus) interface.

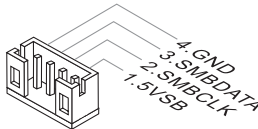

I²C Box Header: JI2C1

This connector is provided for users to connect I²C (Inter-Integrated Circuit) interface.

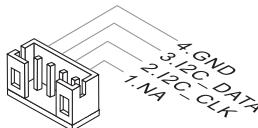

GPI Box Header: JGPIO1

This connector is provided for the General-Purpose Input peripheral module.

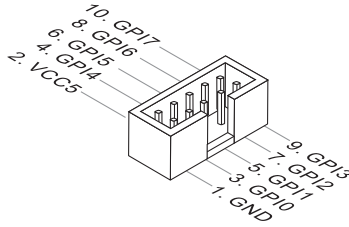

GPO Box Header: JGPIO2

This connector is provided for the General-Purpose Output peripheral module.

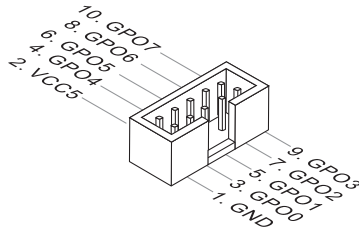

Dual Stacked SATA Connector: SATA1_2, SATA3_4

This connector is a high-speed Serial ATA interface port. Each connector can connect to two SATA devices.

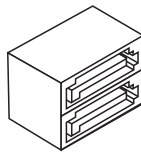

Important

Please do not fold the SATA cable into a 90-degree angle. Otherwise, data loss may occur during transmission.

USB 2.0 Box Header: JUSB1, JUSB2, USB 2.0 Port: USB1

This connector is ideal for connecting USB devices such as keyboard, mouse, or other USB-compatible devices.

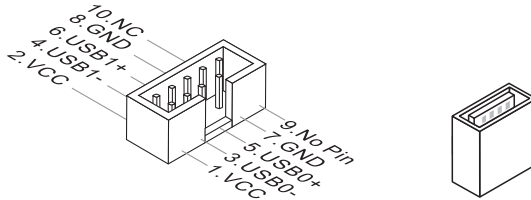

Important

Note that the pins of VCC and GND must be connected correctly to avoid possible damage.

Front Panel Box Header: JFP1

This front panel connector is provided for electrical connection to the front panel switches & LEDs and is compliant with Intel Front Panel I/O Connectivity Design Guide.

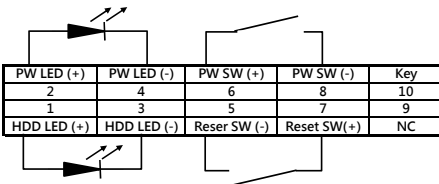
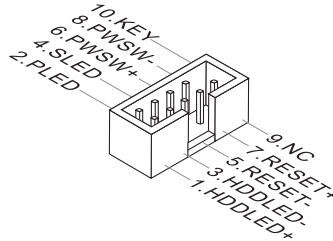

LED(+)	Voltage(V)	Current(mA)
Power	5	18.51
HDD	5	18.51

Chassis Intrusion Header: JCASE1

This connector connects to the chassis intrusion switch cable. If the computer case is opened, the chassis intrusion mechanism will be activated. The system will record this intrusion and a warning message will flash on screen. To clear the warning, you must enter the BIOS utility and clear the record.

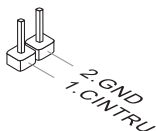

TPM Box Header: JTPM1

This connector works as LPC debug port and supports TPM modules.

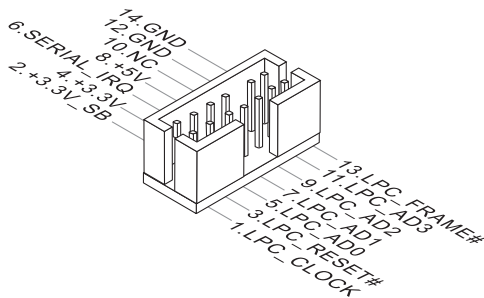

Front Audio Box Header: JAUD1

This connector allows you to connect the front panel audio and is compliant with Intel Front Panel I/O Connectivity Design Guide.

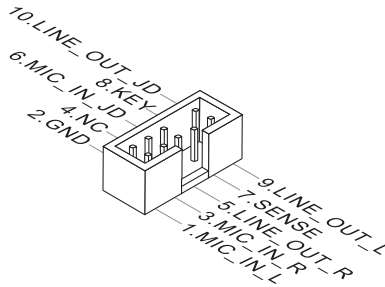

S/PDIF Box Header: JSPDIF1

This pinheader is used to connect S/PDIF (Sony & Philips Digital Interconnect Format) interface for digital audio transmission.

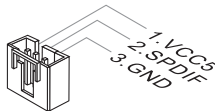

Parallel Port Box Header: JLPT1

The mainboard provides a 26-pin header for connection to an optional parallel port bracket. The parallel port is a standard printer port that supports Enhanced Parallel Port (EPP) and Extended Capabilities Parallel Port (ECP) mode.

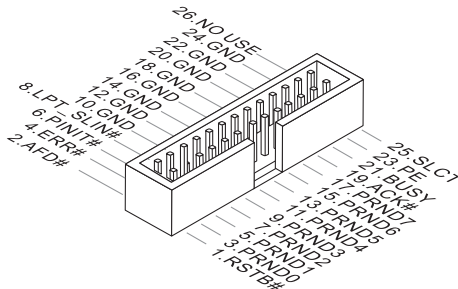

RS232/422/485 COM Port Box Header: JCOM1, JCOM2**RS232 COM Port Box Header: JCOM3, JCOM4, JCOM5, JCOM6**

This connector is a 16550A high speed communications port that sends/receives 16 bytes FIFOs. You can attach a serial device to it.

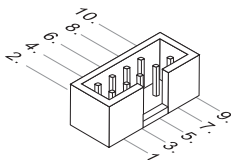
**RS232 (JCOM1, JCOM2)**

PIN	SIGNAL	DESCRIPTION
1	DCD	Data Carrier Detect
2	RXD	Receive Data
3	TXD	Transmit Data
4	DTR	Data Terminal Ready
5	GND	Signal Ground
6	DSR	Data Set Ready
7	RTS	Request To Send
8	CTS	Clear To Send
9	RI / VCC	Ring Indicator / Voltage selected by COM jumper

RS232 (JCOM3, JCOM4, JCOM5, JCOM6)

PIN	SIGNAL	DESCRIPTION
1	DCD	Data Carrier Detect
2	RXD	Receive Data
3	TXD	Transmit Data
4	DTR	Data Terminal Ready
5	GND	Signal Ground
6	DSR	Data Set Ready
7	RTS	Request To Send
8	CTS	Clear To Send
9	VCC	Voltage selected by COM jumper

RS422 (JCOM1, JCOM2)

PIN	SIGNAL	DESCRIPTION
1	422 TXD-	Transmit Data, Negative
2	422 RXD+	Receive Data, Positive
3	422 TXD+	Transmit Data, Positive
4	422 RXD-	Receive Data, Negative
5	GND	Signal Ground
6	NC	No Connection
7	NC	No Connection
8	NC	No Connection
9	NC	No Connection









RS485 (JCOM1, JCOM2)

PIN	SIGNAL	DESCRIPTION
1	485 TXD-	Transmit Data, Negative
2	485 TXD+	Transmit Data, Positive
3	NC	No Connection
4	NC	No Connection
5	GND	Signal Ground
6	NC	No Connection
7	NC	No Connection
8	NC	No Connection
9	NC	No Connection

Jumper

Important

Avoid adjusting jumpers when the system is on; it will damage the motherboard.

Jumper Name	Default Setting	Description	
JCMOS1	 1	1-2: Normal	2-3: Clear CMOS
JATX1	 1	1-2: ATX	2-3: AT
JME_DIS1	 1	1-2: Normal	2-3: ME Disable
JCOMP1 JCOMP2	 6 5 2 1	1-2: 5V 3-4: 12V 5-6: RI	
JCOMP3 JCOMP4 JCOMP5 JCOMP6	 1	1-2: 5V	2-3: 12V
J_CFG1	 1	1-2: 1 x16 PCIe	2-3: 2 x8 PCIe
J_PCISEL1 J_PCISEL2	 1	1-2: 5V	2-3: 3.3V
JNVM2 JNVM3	 1	1-2: Flash Security Enable	2-3: Flash Security Disable

Slot

PCIe (Peripheral Component Interconnect Express) Slot

The PCI Express slot supports PCIe interface expansion cards.

- 5 * PCIe x16 slots
 - PCIe1, PCIe4: 1 * PCIe x16 or 2 * PCIe x8 signal
 - PCIe2, PCIe3, PCIe5: 2 * PCIe x4 NVMe signal

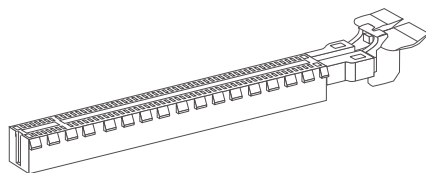

PCIe x16 slot

PCI (Peripheral Component Interconnect) Slot

The PCI slot supports PCI interface expansion cards.

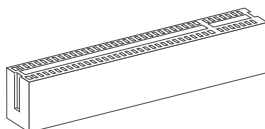

M2_M1: M.2 Key M 2242/2260/2280 Slot for SSD

Please install the M.2 solid-state drive (SSD) into the M.2 slot as shown below.

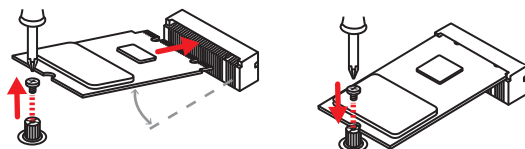

Important

- Intel® RST only supports PCIe M.2 SSD with UEFI ROM and does not support Legacy ROM.
- When adding or removing expansion cards, make sure that you unplug the power supply first. Meanwhile, read the documentation for the expansion card to configure any necessary hardware or software settings for the expansion card, such as jumpers, switches or BIOS configuration.

3 BIOS Setup

This chapter provides information on the BIOS Setup program and allows users to configure the system for optimal use.

Users may need to run the Setup program when:

- An error message appears on the screen at system startup and requests users to run SETUP.
- Users want to change the default settings for customized features.

Important

- *Please note that BIOS update assumes technician-level experience.*
- *As the system BIOS is under continuous update for better system performance, the illustrations in this chapter should be held for reference only.*

Entering Setup

Power on the computer and the system will start POST (Power On Self Test) process. When the message below appears on the screen, press or <F2> key to enter Setup.

Press or <F2> to enter SETUP

If the message disappears before you respond and you still wish to enter Setup, restart the system by turning it OFF and On or pressing the RESET button. You may also restart the system by simultaneously pressing <Ctrl>, <Alt>, and <Delete> keys.

Important

The items under each BIOS category described in this chapter are under continuous update for better system performance. Therefore, the description may be slightly different from the latest BIOS and should be held for reference only.

Control Keys

← →	Select Screen
↑ ↓	Select Item
Enter	Select
+ -	Change Option
F1	General Help
F7	Previous Values
F9	Optimized Defaults
F10	Save & Reset
Esc	Exit

Getting Help

After entering the Setup menu, the first menu you will see is the Main Menu.

Main Menu

The main menu lists the setup functions you can make changes to. You can use the arrow keys (↑ ↓) to select the item. The on-line description of the highlighted setup function is displayed at the bottom of the screen.

Sub-Menu

If you find a right pointer symbol appears to the left of certain fields that means a sub-menu can be launched from this field. A sub-menu contains additional options for a field parameter. You can use arrow keys (↑ ↓) to highlight the field and press <Enter> to call up the sub-menu. Then you can use the control keys to enter values and move from field to field within a sub-menu. If you want to return to the main menu, just press the <Esc >.

General Help <F1>

The BIOS setup program provides a General Help screen. You can call up this screen from any menu by simply pressing <F1>. The Help screen lists the appropriate keys to use and the possible selections for the highlighted item. Press <Esc> to exit the Help screen.

The Menu Bar

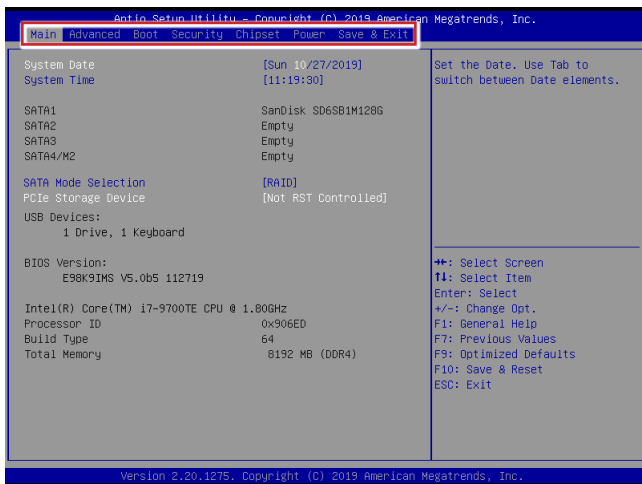

► Main

Use this menu for basic system configurations, such as time, date, etc.

► Advanced

Use this menu to set up the items of special enhanced features.

► Boot

Use this menu to specify the priority of boot devices.

► Security

Use this menu to set supervisor and user passwords.

► Chipset

This menu controls the advanced features of the onboard chipsets.

► Power

Use this menu to specify your settings for power management.

► Save & Exit

This menu allows you to load the BIOS default values or factory default settings into the BIOS and exit the BIOS setup utility with or without changes.

Main

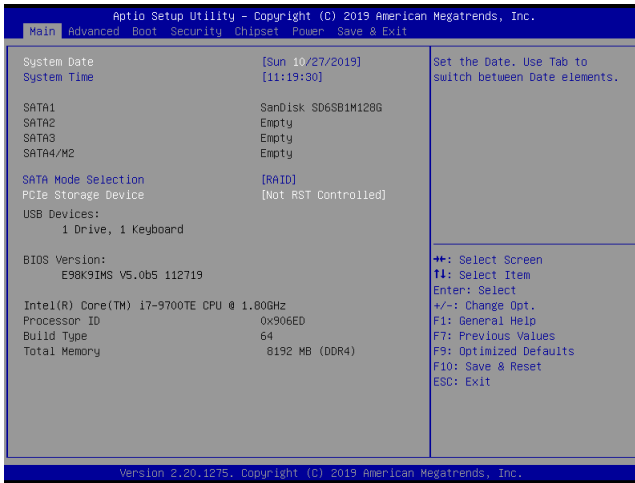

► System Date

This setting allows you to set the system date. The date format is <Day>, <Month> <Date> <Year>.

► System Time

This setting allows you to set the system time. The time format is <Hour> <Minute> <Second>.

► SATA Mode Selection

This setting specifies the SATA controller mode.

► PCIe Storage Device

This setting controls the Intel® RST (Rapid Storage Technology) support for PCIe storage devices. Setting to **RST Controlled** will enable Intel® Optane™ Memory. Since PCIe storage devices can't be recognized by Intel® RST in AHCI mode, please set **SATA Mode Selection** to **RAID** to enable RST support for PCIe storage devices.

Advanced

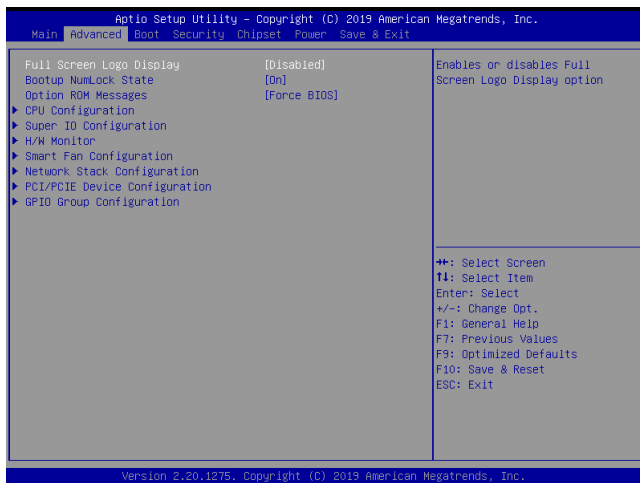

► Full Screen Logo Display

This BIOS feature determines if the BIOS should hide the normal POST messages with the motherboard or system manufacturer's full-screen logo.

When it is enabled, the BIOS will display the full-screen logo during the boot-up sequence, hiding normal POST messages.

When it is disabled, the BIOS will display the normal POST messages, instead of the full-screen logo.

Please note that enabling this BIOS feature often adds 2-3 seconds of delay to the booting sequence. This delay ensures that the logo is displayed for a sufficient amount of time. Therefore, it is recommended that you disable this BIOS feature for a faster boot-up time.

► Bootup NumLock State

This setting is to set the Num Lock status when the system is powered on. Setting to [On] will turn on the Num Lock key when the system is powered on. Setting to [Off] will allow users to use the arrow keys on the numeric keypad.

► Option ROM Messages

This item is used to determine the display mode when an optional ROM is initialized during POST. When set to [Force BIOS], the display mode used by AMI BIOS is used. Select [Keep Current] if you want to use the display mode of optional ROM.

► CPU Configuration

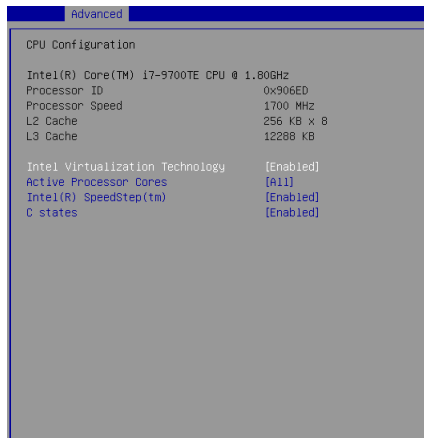

► Intel Virtualization Technology

Virtualization enhanced by Intel Virtualization Technology will allow a platform to run multiple operating systems and applications in independent partitions. With virtualization, one computer system can function as multiple “Virtual” systems.

► Active Processor Cores

This setting specifies the number of active processor cores.

► Intel(R) SpeedStep(tm)

EIST (Enhanced Intel SpeedStep Technology) allows the system to dynamically adjust processor voltage and core frequency, which can result in decreased average power consumption and decreased average heat production. When disabled, the processor will return the actual maximum CPUID input value of the processor when queried.

► C States

This setting controls the C-State (CPU Power state). C-State performance indicates the ability to run the processor in lower power states when the PC is idle. This setting enables/disables the C-State Configuration for power saving purposes.

► Super IO Configuration

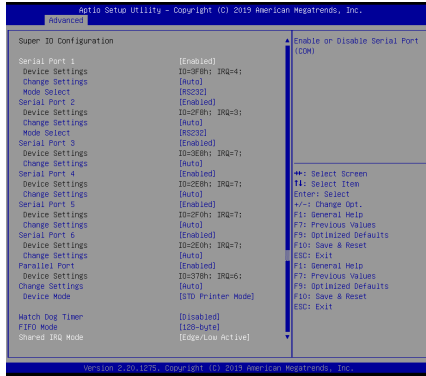

► Serial Port 1 ~ Serial Port 6

This setting enables/disables the specified serial port.

► Change Settings

This setting is used to change the address & IRQ settings of the specified serial port.

► Mode Select

Select an operation mode for the specified serial port.

► Parallel Port

This setting enables/disables the parallel port.

► Change Settings

This setting is used to change the address & IRQ settings of the parallel port.

► Device Mode

Select an operation mode for the parallel port.

► Watch Dog Timer

You can enable the system watch-dog timer, a hardware timer that generates a reset when the software that it monitors does not respond as expected each time the watch dog polls it.

► FIFO Mode

This setting controls the FIFO data transfer mode.

► Shared IRQ Mode

This setting provides the system with the ability to share interrupts among its serial ports.

► H/W Monitor

These items display the current status of all monitored hardware devices/ components such as voltages, temperatures and all fans' speeds.

Advanced	
PC Health Status	
CPU temperature	: +30 C
System temperature	: +23 C
CPUFAN1	: 4531 RPM
SYSFAN1	: N/A
SYSFAN2	: N/A
SYSFAN3	: N/A
VCC_CORE	: +0.792 V
VCC3	: +3.336 V
VCC5	: +5.045 V
+12V	: +12.232 V
VS3V	: +3.312 V
VS5V	: +4.944 V
VBAT	: +3.056 V

► Smart Fan Configuration

Advanced	
Configuration Smart FAN	
CPUFAN1	[Disabled]
SYSFAN1	[Disabled]
Type	[4 Pin]
SYSFAN2	[Disabled]
Type	[4 Pin]
SYSFAN3	[Disabled]
Type	[4 Pin]

► CPUFAN1, SYSFAN1 ~ SYSFAN3

This setting enables/disables the Smart Fan function. Smart Fan is an excellent feature which will adjust the CPU/system fan speed automatically depending on the current CPU/system temperature, avoiding the overheating to damage your system.

► **Network Stack Configuration**

This menu provides Network Stack settings for users to enable network boot (PXE) from BIOS.



► **PCI/PCIE Device Configuration**

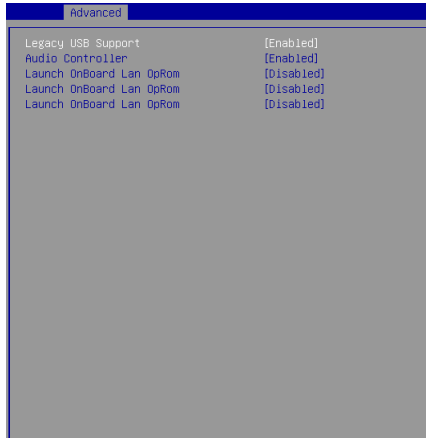

► **Legacy USB Support**

Set to [Enabled] if you need to use any USB 1.1/2.0 device in the operating system that does not support or have any USB 1.1/2.0 driver installed, such as DOS and SCO Unix.

► **Audio Controller**

This setting enables/disables the onboard audio controller.

► **Launch OnBoard LAN OpROM**

These settings enable/disable the initialization of the onboard/onchip LAN Boot ROM during bootup. Selecting [Disabled] will speed up the boot process.

▶ GPIO Group Configuration

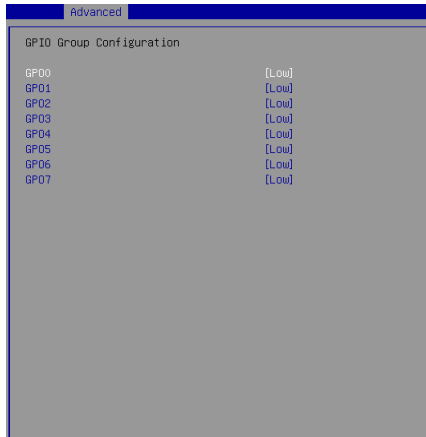

Advanced	
GPIO Group Configuration	
GP00	[Low]
GP01	[Low]
GP02	[Low]
GP03	[Low]
GP04	[Low]
GP05	[Low]
GP06	[Low]
GP07	[Low]

▶ GPO0 ~ GPO7

These settings control the operation mode of the specified GPIO.

Boot

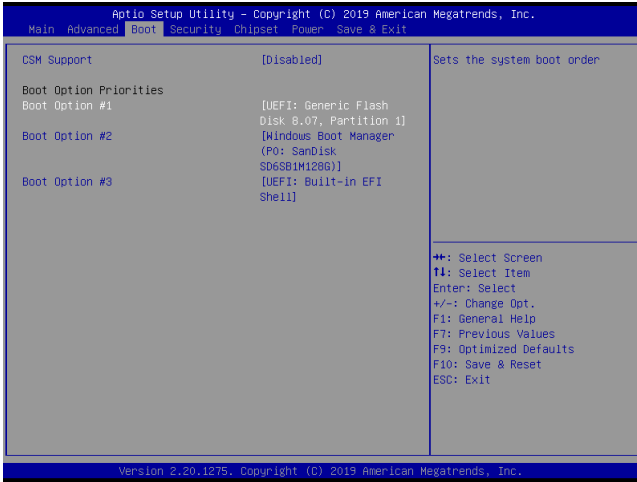

► **CSM Support**

This setting enables/disables the support for Compatibility Support Module, a part of the Intel Platform Innovation Framework for EFI providing the capability to support legacy BIOS interfaces.

► **Boot Option Priorities**

This setting allows users to set the sequence of boot devices where BIOS attempts to load the disk operating system.

Security

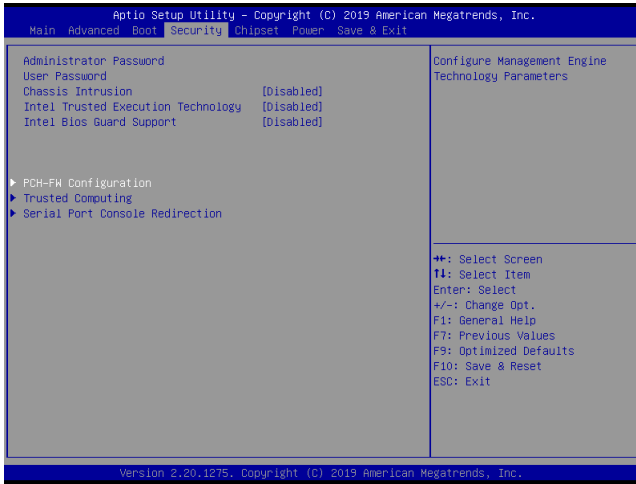

► Administrator Password

Administrator Password controls access to the BIOS Setup utility.

► User Password

User Password controls access to the system at boot and to the BIOS Setup utility.

► Chassis Intrusion

The field enables or disables the feature of recording the chassis intrusion status and issuing a warning message if the chassis is once opened.

► Intel Trusted Execution Technology

Intel Trusted Execution Technology provides highly scalable platform security in physical and virtual infrastructures.

► Intel BIOS Guard Support

Intel BIOS Guard Support ensures that updates to system BIOS flash are secure.

► PCH-FW Configuration

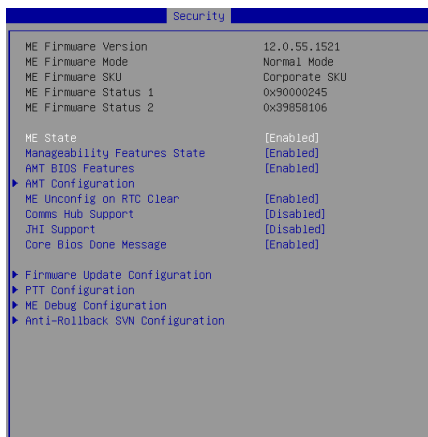

► ME Firmware Version, ME Firmware Mode, ME Firmware SKU, ME Firmware Status 1, ME Firmware Status 2

These settings show the firmware information of the Intel ME (Management Engine).

► ME State

This setting enables/disables the ME status.

► Manageability Features State

This setting enables/disables the Manageability Features State.

► AMT BIOS Features

This setting enables/disables the AMT BIOS Features.

► AMT Configuration

Intel Active Management Technology (AMT) is hardware-based technology for remotely managing and securing PCs out-of-band.

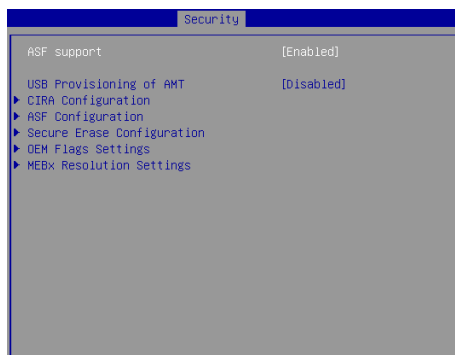

► **ME Unconfig on RTC Clear**

This setting enables/disables ME firmware unconfigure on RTC clear.

► **Comms Hub Support**

This setting enables/disables Communications Hub Support.

► **JHI Support**

This setting enables/disables support for Intel Dynamic Application Loader Host Interface (JHI).

► **Core BIOS Done Message**

This setting enables/disables Core BIOS Done Message sent to ME.

► **Firmware Update Configuration**



► **ME FW Image Re-Flash**

This setting enables/disables the ME FW image reflash.

► **PTT Configuration**

Intel Platform Trust Technology (PTT) is a platform functionality for credential storage and key management used by Microsoft Windows.

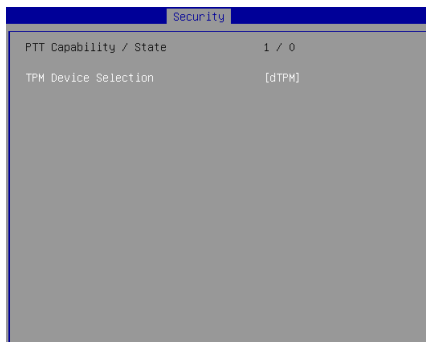

► ME Debug Configuration

Security	
HECI Timeouts	[Enabled]
Force ME DID Init Status	[Disabled]
CPU Replaced Polling Disable	[Disabled]
ME DID Message	[Enabled]
HECI Retry Disable	[Disabled]
HECI Message check Disable	[Disabled]
HBP_HOB Skip	[Disabled]
HECI2 Interface Communication	[Disabled]
KT Device	[Enabled]
End Of Post Message	[Send in DXE]
DOT3 Setting for HECI Disable	[Disabled]
MCTP Broadcast Cycle	[Disabled]

► Anti-Rollback SVN Configuration

Security	
Minimal Allowed Anti-Rollback SVN	1
Executing Anti-Rollback SVN	6
Automatic HW-Enforced	[Disabled]
Anti-Rollback SVN	
Set HW-Enforced Anti-Rollback for Current SVN	[Disabled]

► Trusted Computing

Security	
TPM20 Device Found	
Firmware Version:	5.63
Vendor:	IFX
Security Device Support	[Enable]
Active PCR banks	SHA-1,SHA256
Available PCR banks	SHA-1,SHA256
SHA-1 PCR Bank	[Enabled]
SHA256 PCR Bank	[Enabled]
Pending operation	[None]
Platform Hierarchy	[Enabled]
Storage Hierarchy	[Enabled]
Endorsement Hierarchy	[Enabled]
TPM2.0 UEFI Spec Version	[TCG_2]
Physical Presence Spec Version	[1.3]
TPM 20 InterfaceType	[IIS]
Device Select	[Auto]

► Security Device Support

This setting enables/disables BIOS support for security device. When set to [Disable], the OS will not show security device. TCG EFI protocol and INT1A interface will not be available.

► SHA-1 PCR Bank, SHA256 PCR Bank

These settings enable/disable the SHA-1 PCR Bank and SHA256 PCR Bank.

► Pending Operation

When **Security Device Support** is set to [Enable], **Pending Operation** will appear. Set this item to [TPM Clear] to clear all data secured by TPM or [None] to discard the selection. It is advised that users should routinely back up their TPM secured data.

► Platform Hierarchy, Storage Hierarchy, Endorsement Hierarchy

These settings enable/disable the Platform Hierarchy, Storage Hierarchy and Endorsement Hierarchy.

► TPM2.0 UEFI Spec Version, Physical Presence Spec Version

This settings show the TPM2.0 UEFI Spec Version and Physical Presence Spec Version.

► TPM2.0 Interface Type

This setting shows the TPM2.0 Interface Type.

► Device Select

This setting allows users to select the TPM device.

► **Serial Port Console Redirection**

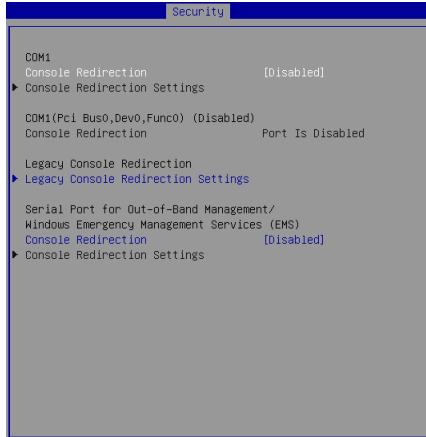

COM1

► **Console Redirection**

Console Redirection operates in host systems that do not have a monitor and keyboard attached. This setting enables/disables the operation of console redirection. When set to [Enabled], BIOS redirects and sends all contents that should be displayed on the screen to the serial COM port for display on the terminal screen. Besides, all data received from the serial port is interpreted as keystrokes from a local keyboard.

► **Console Redirection Settings**

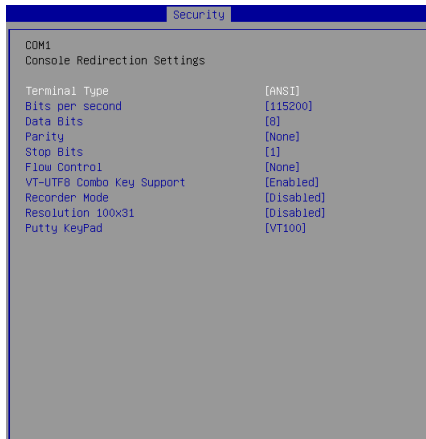

► **Terminal Type**

To operate the system's console redirection, you need a terminal supporting ANSI terminal protocol and a RS-232 null modem cable connected between

the host system and terminal(s). This setting specifies the type of terminal device for console redirection.

► **Bits per second, Data Bits, Parity, Stop Bits**

This setting specifies the transfer rate (bits per second, data bits, parity, stop bits) of Console Redirection.

► **Flow Control**

Flow control is the process of managing the rate of data transmission between two nodes. It's the process of adjusting the flow of data from one device to another to ensure that the receiving device can handle all of the incoming data. This is particularly important where the sending device is capable of sending data much faster than the receiving device can receive it.

► **VT-UTF8 Combo Key Support**

This setting enables/disables the VT-UTF8 combination key support for ANSI/VT100 terminals.

► **Recorder Mode, Resolution 100x31**

These settings enable/disable the recorder mode and the resolution 100x31.

► **Putty Keypad**

PuTTY is a terminal emulator for Windows. This setting controls the numeric keypad for use in PuTTY.

Legacy Console Redirection

► **Legacy Console Redirection Settings**

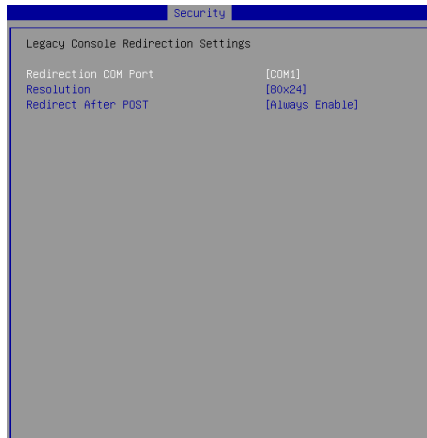

► **Redirection COM Port**

This setting specifies the COM port for redirection.

► **Resolution**

This setting specifies the redirection resolution of legacy OS.

► **Redirect After POST**

This setting determines whether or not to keep terminals' console redirection running after the POST has booted.

Serial Port for Out-of-Band Management/ Windows Emergency Management Services (EMS)

► **Console Redirection**

Console Redirection operates in host systems that do not have a monitor and keyboard attached. This setting enables/disables the operation of console redirection. When set to [Enabled], BIOS redirects and sends all contents that should be displayed on the screen to the serial COM port for display on the terminal screen. Besides, all data received from the serial port is interpreted as keystrokes from a local keyboard.

► **Console Redirection Settings**

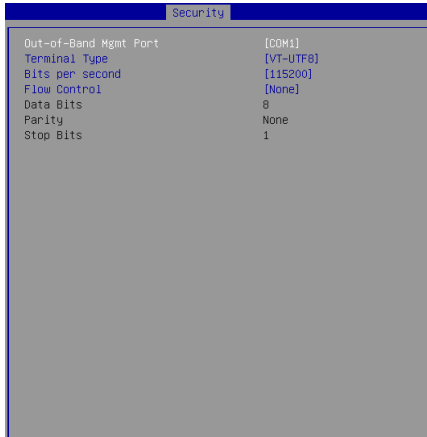

► **Out-of-Band Mgmt Port**

This setting specifies the Out-of-Band Management Port.

► **Terminal Type**

To operate the system's console redirection, you need a terminal supporting ANSI terminal protocol and a RS-232 null modem cable connected between the host system and terminal(s). This setting specifies the type of terminal device for console redirection.

► **Bits per second, Data Bits, Parity, Stop Bits**

This setting specifies the transfer rate (bits per second, data bits, parity, stop bits) of Console Redirection.

► **Flow Control**

Flow control is the process of managing the rate of data transmission between two nodes. It's the process of adjusting the flow of data from one device to another to ensure that the receiving device can handle all of the incoming data. This is particularly important where the sending device is capable of sending data much faster than the receiving device can receive it.

Chipset

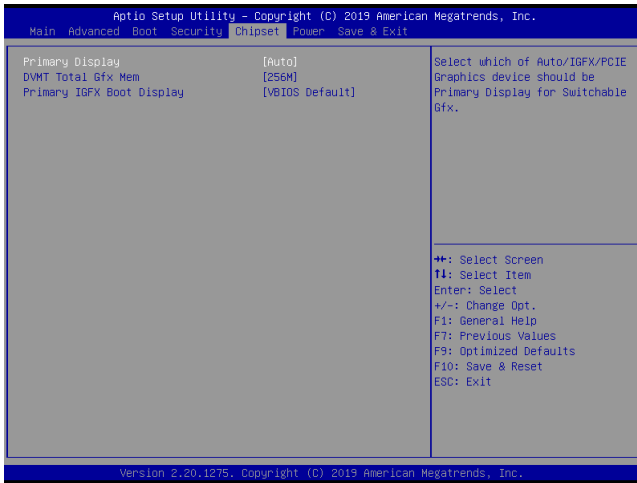

► Primary Display

Use the field to select the type of device you want to use as the display(s) of the system.

► DVMT Total Gfx Mem

This setting specifies the memory size for DVMT.

► Primary IGFX Boot Display

Use the field to select the primary IGFX boot display of the system.

Power

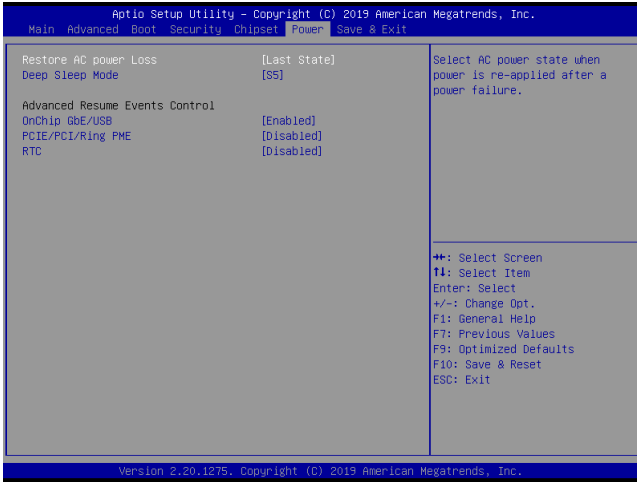

► Restore AC Power Loss

This setting specifies whether your system will reboot after a power failure or interrupt occurs. Available settings are:

[Power Off]	Leaves the computer in the power off state.
[Power On]	Leaves the computer in the power on state.
[Last State]	Restores the system to the previous status before power failure or interrupt occurred.

► Deep Sleep Mode

The setting enables/disables the Deep S5 power saving mode. S5 is almost the same as G3 Mechanical Off, except that the PSU still supplies power, at a minimum, to the power button to allow return to S0. A full reboot is required. No previous content is retained. Other components may remain powered so the computer can “wake” on input from the keyboard, clock, modem, LAN, or USB device.

**** Advanced Resume Events Control ******▶ OnChip GbE/USB**

This field specifies whether the system will be awakened from power saving modes when activity or input signal of onchip LAN or USB devices is detected.

▶ PCIE/PCI/Ring PME

This field specifies whether the system will be awakened from power saving modes when activity or input signal of onboard PCIE/PCI/Ring PME is detected.

▶ RTC

When [Enabled], you can set the date and time at which the RTC (real-time clock) alarm awakens the system from suspend mode.

Save & Exit

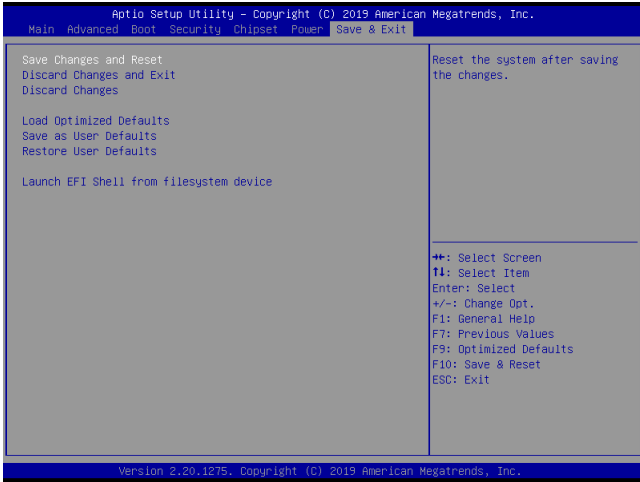

► Save Changes and Reset

Save changes to CMOS and reset the system.

► Discard Changes and Exit

Abandon all changes and exit the Setup Utility.

► Discard Changes

Abandon all changes.

► Load Optimized Defaults

Use this menu to load the default values set by the motherboard manufacturer specifically for optimal performance of the motherboard.

► Save as User Defaults

Save changes as the user's default profile.

► Restore User Defaults

Restore the user's default profile.

► Launch EFI Shell from filesystem device

This setting helps to launch the EFI Shell application from one of the available file system devices.

Appendix

GPIO WDT Programming



This appendix provides WDT (Watch Dog Timer) and GPIO (General Purpose Input/Output) programming guide.

Abstract

In this document, code examples based on C programming language are provided for customer interest. **Inportb**, **Outportb**, **Inportl** and **Outportl** are basic functions used for access IO ports and defined as following.

Inportb: Read a single 8-bit I/O port.

Outportb: Write a single byte to an 8-bit port.

Inportl: Reads a single 32-bit I/O port.

Outportl: Write a single long to a 32-bit port.

General Purposed IO

1. General Purposed IO – GPIO/DIO

The GPIO port configuration addresses are listed in the following table:

Name	IO Port	IO address	Name	IO Port	IO address
N_GPIO0	0x12	Bit 0	N_GPO0	0x21	Bit 0
N_GPI1	0x12	Bit 1	N_GPO1	0x21	Bit 1
N_GPIO2	0x12	Bit 2	N_GPO2	0x21	Bit 2
N_GPI3	0x42	Bit 3	N_GPO3	0x21	Bit 3
N_GPIO4	0x12	Bit 4	N_GPO4	0x21	Bit 4
N_GPI5	0x12	Bit 5	N_GPO5	0x21	Bit 5
N_GPIO6	0x12	Bit 6	N_GPO6	0x21	Bit 6
N_GPIO7	0x12	Bit 7	N_GPO7	0x21	Bit 7

Note: GPIO should be accessed through controller device **0x6E** on SMBus. The associated access method in examples (**SMBus_ReadByte**, **SMBus_WriteByte**) are provided in part 3.

1.1 Set output value of GPO

1. Read the value from GPO port.
2. Set the value of GPO address.
3. Write the value back to GPO port.

Example: Set **N_GPO0** output “high”

```
val = SMBus_ReadByte (0x6E, 0x21); // Read value from N_GPO0 port through SMBus.
val = val | (1<<0); // Set N_GPO0 address (bit 0) to 1 (output “high”).
SMBus_WriteByte (0x6E, 0x21, val); // Write back to N_GPO0 port through SMBus.
```

Example: Set **N_GPO1** output “low”

```
val = SMBus_ReadByte (0x6E, 0x21); // Read value from N_GPO1 port through SMBus..
val = val & (~(1<<1)); // Set N_GPO1 address (bit 1) to 0 (output “low”).
SMBus_WriteByte (0x6E, 0x21, val); // Write back to N_GPO1 port through SMBus.
```

1.2 Read input value from GPI

1. Read the value from GPI port.
2. Get the value of GPI address.

Example: Get **N_GPI2** input value.

```
val = SMBus_ReadByte (0x6E, 0x12); // Read value from N_GPI2 port through SMBus.
val = val & (1<<2); // Read N_GPI2 address (bit 2).
if (val) printf (“Input of N_GPI2 is High”);
else printf (“Input of N_GPI2 is Low”);
```

Example: Get **N_GPI3** input value.

```
val = SMBus_ReadByte (0x6E, 0x12); // Read value from N_GPI3 port through SMBus.
val = val & (1<<3); // Read N_GPI3 address (bit 3).
if (val) printf (“Input of N_GPI3 is High”);
else printf (“Input of N_GPI3 is Low”);
```

Watchdog Timer

2. Watchdog Timer – WDT

The base address (WDT_BASE) of WDT configuration registers is [0xA10](#).

2.1 Set WDT Time Unit

```
val = Inportb (WDT_BASE + 0x05); // Read current WDT setting
val = val | 0x08; // minute mode. val = val & 0xF7 if second mode
Outportb (WDT_BASE + 0x05, val); // Write back WDT setting
```

2.2 Set WDT Time

```
Outportb (WDT_BASE + 0x06, Time); // Write WDT time, value 1 to 255.
```

2.3 Enable WDT

```
val = Inportb (WDT_BASE + 0x0A); // Read current WDT_PME setting
val = val | 0x01; // Enable WDT OUT: WDOUT_EN (bit 0) set to 1.
Outportb (WDT_BASE + 0x0A, val); // Write back WDT setting.
val = Inportb (WDT_BASE + 0x05); // Read current WDT setting
val = val | 0x20; // Enable WDT by set WD_EN (bit 5) to 1.
Outportb (WDT_BASE + 0x05, val); // Write back WDT setting.
```

2.4 Disable WDT

```
val = Inportb (WDT_BASE + 0x05); // Read current WDT setting
val = val & 0xDF; // Disable WDT by set WD_EN (bit 5) to 0.
Outportb (WDT_BASE + 0x05, val); // Write back WDT setting.
```

2.5 Check WDT Reset Flag

If the system has been reset by WDT function, this flag will set to 1.

```
val = Inportb (WDT_BASE + 0x05); // Read current WDT setting.
val = val & 0x40; // Check WDTMOUT_STS (bit 6).
if (val) printf ("timeout event occurred");
else printf ("timeout event not occurred");
```

2.6 Clear WDT Reset Flag

```
val = Inportb (WDT_BASE + 0x05); // Read current WDT setting
val = val | 0x40; // Set 1 to WDTMOUT_STS (bit 6);
Outportb (WDT_BASE + 0x05, val); // Write back WDT setting
```

SMBus Access

3. SMBus Access

The base address of SMBus must be known before access. The relevant bus and device information are as following.

```
#define IO_SC          0xCF8
#define IO_DA          0xCFC
#define PCIBASEADDRESS 0x80000000
#define PCI_BUS_NUM    0
#define PCI_DEV_NUM    31
#define PCI_FUN_NUM    4
```

3.1 Get SMBus Base Address

```
int SMBUS_BASE;
int DATA_ADDR = PCIBASEADDRESS + (PCI_BUS_NUM<<16) +
(PCI_DEV_NUM<<11) +
(PCI_FUN_NUM<<8);
```

```
Outportl (DATA_ADDR + 0x20, IO_SC);
SMBUS_BASE = Inportl (IO_DA) & 0xfffffff0;
```

3.2 SMBus_ReadByte (char DEVID, char offset)

Read the value of OFFSET from SMBus device DEVID.

```
Outportb (LOWORD (SMBUS_BASE), 0xFE);
Outportb (LOWORD (SMBUS_BASE) + 0x04, DEVID + 1); //out Base + 04, (DEVID + 1)
Outportb (LOWORD (SMBUS_BASE) + 0x03, OFFSET); //out Base + 03, OFFSET
Outportb (LOWORD (SMBUS_BASE) + 0x02, 0x48); //out Base + 02, 48H
mdelay (20); //delay 20ms to let data ready
while ((Inportl (SMBUS_BASE) & 0x01) != 0); //wait SMBus ready
SMB_DATA = Inportb (LOWORD (SMBUS_BASE) + 0x05); //input Base + 05
```

3.3 SMBus_WriteByte (char DEVID, char offset, char DATA)

Write DATA to OFFSET on SMBus device DEVID.

```
Outportb (LOWORD (SMBUS_BASE), 0xFE);
Outportb (LOWORD (SMBUS_BASE) + 0x04, DEVID); //out Base + 04, (DEVID)
Outportb (LOWORD (SMBUS_BASE) + 0x03, OFFSET); //out Base + 03, OFFSET
Outportb (LOWORD (SMBUS_BASE) + 0x05, DATA); //out Base + 05, DATA
Outportb (LOWORD (SMBUS_BASE) + 0x02, 0x48); //out Base + 02, 48H
mdelay (20); //wait 20ms
```