

MI998AF

**Intel® 9th / 8th Gen. Xeon® E /
Core™ / Celeron® / Pentium®
Mini-ITX Motherboard**

User's Manual

Version 1.0
(May. 2019)

Copyright

© 2019 IBASE Technology, Inc. All rights reserved.

No part of this publication may be reproduced, copied, stored in a retrieval system, translated into any language or transmitted in any form or by any means, electronic, mechanical, photocopying, or otherwise, without the prior written consent of IBASE Technology, Inc. (hereinafter referred to as "IBASE").

Disclaimer

IBASE reserves the right to make changes and improvements to the products described in this document without prior notice. Every effort has been made to ensure the information in the document is correct; however, IBASE does not guarantee this document is error-free.

IBASE assumes no liability for incidental or consequential damages arising from misapplication or inability to use the product or the information contained herein, nor for any infringements of rights of third parties, which may result from its use.

Trademarks

All the trademarks, registrations and brands mentioned herein are used for identification purposes only and may be trademarks and/or registered trademarks of their respective owners.

Compliance



This is a class B product. In a domestic environment, this product may cause radio interference in which case users may be required to take adequate measures.



This product has been tested and found to comply with the limits for a Class A device, pursuant to Part 15 of the FCC Rules. These limits are designed to provide reasonable protection against harmful interference in a residential installation. This equipment generates, uses and can radiate radio frequency energy and, if not installed and used in accordance with manufacturer's instructions, may cause harmful interference to radio communications.

WEEE



This product must not be disposed of as normal household waste, in accordance with the EU directive of for waste electrical and electronic equipment (WEEE - 2012/19/EU). Instead, it should be disposed of by returning it to a municipal recycling collection point. Check local regulations for disposal of electronic products.

Green IBASE



This product is compliant with the current RoHS restrictions and prohibits use of the following substances in concentrations exceeding 0.1% by weight (1000 ppm) except for cadmium, limited to 0.01% by weight (100 ppm).

- Lead (Pb)
- Mercury (Hg)
- Cadmium (Cd)
- Hexavalent chromium (Cr6+)
- Polybrominated biphenyls (PBB)
- Polybrominated diphenyl ether (PBDE)

Important Safety Information

Carefully read the precautions before using the board.

Environmental conditions:

- Use this product in environments with ambient temperatures between 0°C and 60°C.
- Do not leave this product in an environment where the storage temperature may be below -20° C or above 80° C. To prevent from damages, the product must be used in a controlled environment.

Care for your iBASE products:

- Before cleaning the PCB, unplug all cables and remove the battery.
- Clean the PCB with a circuit board cleaner or degreaser, or use cotton swabs and alcohol.
- Vacuum the dust with a computer vacuum cleaner to prevent the fan from being clogged.



WARNING

Attention during use:

- Do not use this product near water.
- Do not spill water or any other liquids on this product.
- Do not place heavy objects on the top of this product.

Anti-static precautions

- Wear an anti-static wrist strap to avoid electrostatic discharge.
- Place the PCB on an anti-static kit or mat.
- Hold the edges of PCB when handling.
- Touch the edges of non-metallic components of the product instead of the surface of the PCB.
- Ground yourself by touching a grounded conductor or a grounded bit of metal frequently to discharge any static.



CAUTION

Danger of explosion if the internal lithium-ion battery is replaced by an incorrect type. Replace only with the same or equivalent type recommended by the manufacturer. Dispose of used batteries according to the manufacturer's instructions or recycle them at a local recycling facility or battery collection point.

Warranty Policy

- **IBASE standard products:**

24-month (2-year) warranty from the date of shipment. If the date of shipment cannot be ascertained, the product serial numbers can be used to determine the approximate shipping date.

- **3rd-party parts:**

12-month (1-year) warranty from delivery for the 3rd-party parts that are not manufactured by IBASE, such as CPU, CPU cooler, memory, storage devices, power adapter, panel and touchscreen.

- * PRODUCTS, HOWEVER, THAT FAIL DUE TO MISUSE, ACCIDENT, IMPROPER INSTALLATION OR UNAUTHORIZED REPAIR SHALL BE TREATED AS OUT OF WARRANTY AND CUSTOMERS SHALL BE BILLED FOR REPAIR AND SHIPPING CHARGES.

Technical Support & Services

1. Visit the IBASE website at www.ibase.com.tw to find the latest information about the product.
2. If you need any further assistance from your distributor or sales representative, prepare the following information of your product and elaborate upon the problem.
 - Product model name
 - Product serial number
 - Detailed description of the problem
 - The error messages in text or in screenshots if there is any
 - The arrangement of the peripherals
 - Software in use (such as OS and application software, including the version numbers)
3. If repair service is required, you can download the RMA form at <http://www.ibase.com.tw/english/Supports/RMAService/>. Fill out the form and contact your distributor or sales representative.

Table of Contents

Compliance	iii
Important Safety Information	iv
Warranty Policy	v
Technical Support & Services	v
Chapter 1 General Information	1
1.1 Introduction	2
1.2 Features	2
1.3 Packing List	3
1.4 Optional Accessories	3
1.5 Specifications	4
1.6 Block Diagram	6
1.7 Overview	7
1.8 Dimensions	9
Chapter 2 Hardware Configuration	11
2.1 Installations	12
2.1.1 Installing the CPU	12
2.1.2 Installing the Memory	12
2.2 Setting the Jumpers	13
2.2.1 How to Set Jumpers	13
2.3 Jumper & Connector Locations on MI998	14
2.4 Jumpers Quick Reference	18
2.4.1 eDP Panel Power Selection (JP5)	18
2.4.2 Clearing CMOS Data (JP9)	19
2.4.3 Clearing ME Register (JP8)	20
2.4.4 ATX & AT Power Mode Selection (JP1)	21
2.4.5 LVDS Power Brightness Selection (JP4)	22
2.4.6 LVDS Panel Power Selection (JP6)	23
2.4.7 PCIe (x16) Bifurcation Selection (JP2 & JP3)	24
2.5 Connectors Quick Reference	25
2.5.1 COM1 & COM2 RS-232/422/485 Ports (CN1)	26
2.5.2 COM3 & COM4 RS-232 Ports (J5, J6)	27
2.5.3 eDP Connector (CN6)	28

2.5.4	Digital I/O Connector (J2)	29
2.5.5	LCD Backlight Connector (J10)	29
2.5.6	ATX Power Connector (J7)	30
2.5.7	ATX 12V Power Connector (ATX_12V_2x1)	31
2.5.8	Dual USB 2.0 Connector (J14)	31
2.5.9	Front Panel Audio Connector (J16).....	32
2.5.10	Front Panel Settings Connector (J18).....	33
2.5.11	LVDS Connector (J11, J12).....	34
2.5.12	Fan Power Connector (SYS_FAN1, CPU_FAN1)	35

Chapter 3 Drivers Installation 37

3.1	Introduction.....	38
3.2	Intel® Chipset Software Installation Utility	38
3.3	HD Graphics Driver Installation	39
3.4	HD Audio Driver Installation	40
3.5	LAN Driver Installation	41
3.6	Intel® Management Engine Drivers Installation	43

Chapter 4 BIOS Setup..... 44

4.1	Introduction.....	45
4.2	BIOS Setup.....	45
4.3	Main Settings.....	46
4.4	Advanced Settings.....	47
4.4.1	Connectivity Configuration	48
4.4.2	CPU Configuration.....	49
4.4.3	PCH-FW Configuration.....	50
4.4.4	Trusted Computing.....	50
4.4.5	ACPI Settings.....	52
4.4.6	LVDS (eDP/DP) Configuration.....	52
4.4.7	Fintek Super IO Configuration	53
4.4.8	Fintek Super IO Hardware Monitor.....	56
4.4.9	USB Configuration.....	57
4.4.10	Network Configuration	58
4.4.11	CSM Configuration	58
4.4.12	NVMe Configuration	59
4.5	Chipset Settings	60
4.5.1	System Agent (SA) Configuration.....	60
4.5.2	PCH-IO Configuration.....	62
4.6	Security Settings.....	63

iBASE

4.6.1	Secure Boot	63
4.7	Boot Settings.....	65
4.8	Save & Exit Settings.....	66

Appendix 67

A.	I/O Port Address Map.....	68
B.	Interrupt Request Lines (IRQ).....	70
C.	Watchdog Timer Configuration.....	71
D.	On-Board Connector Types.....	75

Chapter 1

General Information

The information provided in this chapter includes:

- Features
- Packing List
- Specifications
- Block Diagram
- Board Overview
- Board Dimensions

1.1 Introduction

MI998 is a Mini-ITX motherboard based on 9th or 8th Gen. Intel® Xeon® E / Core™ / Pentium® / Celeron® processor. It offers high-definition visual experience and high performance on graphics processing. It can also be well utilized for designs of low power consumption in a board range of markets, including industrial control & automation, digital signage, thin client, electronic gaming machines, and SMB storage appliances.



Photo of MI998

1.2 Features

- 2 x DDR4 SO-DIMM, expandable up to 32 GB, ECC supported per CPU SKUs
- Dual Gigabit LAN
- 1 x HDMI, 1 x DisplayPort, 1 x DVI-D, 1 x eDP or 1 x 24-bit dual channel LVDS
- 4 x USB 3.1, 4 x SATA III, 4 x serial ports
- PCIe (x16), M.2 M2280 (for MI998AF series only) and E2230 expansion slots
- Configurable watchdog timer and digital I/O
- TPM compliant

1.3 Packing List

Your product package should include the items listed below. If any of the items below is missing, contact the distributor or dealer from whom you purchased the product.

- MI998AF Motherboard
- I/O Shield
- SATA Cable (SATA-3F)
- COM Port Cable (PK1-20BK)
- Disk (including chipset drivers)
- This User's Manual

1.4 Optional Accessories

IBASE provides optional accessories as follows. Please contact us or your dealer if you need any.

- Audio Cable (Audio-34)
- USB Cable (USB-29)

1.5 Specifications

Product Name	MI998AF Series	MI998EF
Form Factor	Mini-ITX motherboard	
System		
Operating System	<ul style="list-style-type: none"> • Microsoft Windows 10 (64-bit) • Linux Ubuntu (64-bit) • Microsoft Windows Server 2016 (For MI998AF-C246 only) <p>Note: Drivers are supported under Microsoft Windows 10 64-bit (RS3/RS4/RS5) and Server 2016 (RS1) only.</p>	
CPU & Chipset	9 th / 8 th Gen. Intel® Xeon® E / Core™ / Pentium® / Celeron®, up to 4.7 GHz	
Memory	2 x DDR4 SO-DIMM 2666 / 2400 MHz, expandable up to 32 GB * ECC will be supported by identified CPU SKUs.	
Storage	M.2 M2280 slot (NVMe supported)	
Graphics	Intel® UHD Graphics P630	
Network	1 st LAN: Intel® I219LM GbE 2 nd LAN: Intel® I210AT / I211AT GbE	1 st LAN: Intel® I219V GbE 2 nd LAN: Intel® I211AT GbE
Super I/O	Fintek F81964D	
Digital I/O	4-In / 4-Out	
Audio Codec	Built HD audio with Realtek ALC888S	
Watchdog Timer	Yes (256 segments, 0, 1, 2...255 sec / min)	
BIOS	AMI BIOS	
iSmart	N/A	
RAID	RAID 0/1/5	N/A
iAMT	11.6 (with E-Xeon® / Core i7/ i5 DT CPU SKUs)	N/A
TPM	2.0	
EuP / ErP	Compliant	
Dimensions	170 x 170 mm (6.7" x 6.7")	
RoHS	Yes	

Certification	CE, FCC Class A	
I/O Ports		
Display	<ul style="list-style-type: none"> • 1 x HDMI 1.4 (3840 x 2160 at 30 Hz) • 1 x DisplayPort 1.2 (3840 x 2160 at 60 Hz) • 1 x DVI-D (1920 x 1080 at 60 Hz) • 1 x eDP or 24-bit dual channel LVDS (1920 x 1080 at 60 Hz) 	
LAN	2 x RJ45 GbE LAN	
USB	<ul style="list-style-type: none"> • 6 x USB 3.1 (I/O coastline connectors) • 2 x USB 2.0 (via an onboard pin-header) 	<ul style="list-style-type: none"> • 4 x USB 3.1 (I/O coastline connectors) • 2 x USB 2.0 (via an onboard pin header)
Serial	<p>4 x COM ports:</p> <ul style="list-style-type: none"> • COM1 & COM2: RS-232/422/485 (I/O coastline connectors, jumper-less selection) • COM3 ~ COM4: RS-232 only (via onboard box-headers) 	<p>4 x COM ports:</p> <p>COM1 ~ COM4: RS-232 (COM3 & COM4 come from onboard box-headers)</p>
SATA	4 x SATA III	
Audio Jack	1 x Line-In, 1 x Line-Out, 1 x Mic-In	
Digital IO	4-In & 4-Out	
Expansion Slots	<ul style="list-style-type: none"> • 1 x PCIe (x16) • 1 x M.2 M2280 • 1 x M.2 E2230 	<ul style="list-style-type: none"> • 1 x PCIe (x16) • 1 x M.2 E2230
Environment		
Temperature	<ul style="list-style-type: none"> • Operating: 0 ~ 60 °C (32 ~ 140 °F) • Storage: -20 ~ 80 °C (-4 ~ 176 °F) 	
Relative Humidity	0 ~ 90 %, non-condensing at 60 °C	

All specifications are subject to change without prior notice.

1.6 Block Diagram

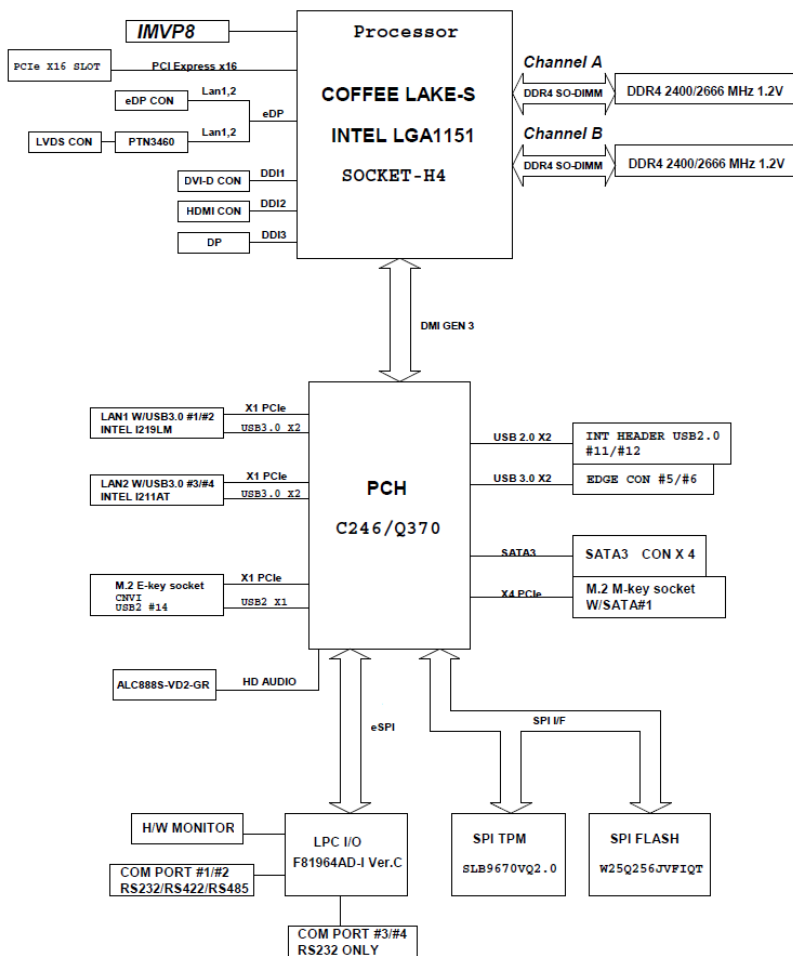

1.7 Overview

Top View



Bottom View



* The photos above are for reference only. Some minor components may differ.

I/O View

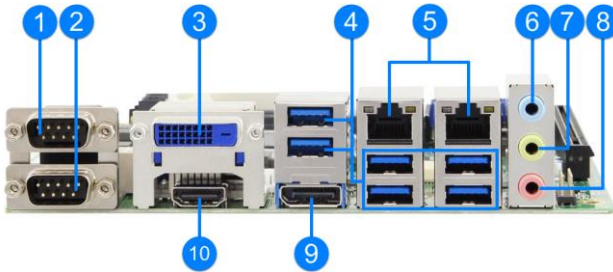

No.	Name	No.	Name
1	COM1 Port	6	Audio Line-In
2	COM2 Port	7	Audio Line-Out
3	DVI-D Port	8	Microphone-In
4	USB 3.0 Ports	9	DisplayPort
5	GbE LAN Ports	10	HDMI Port

1.8 Dimensions

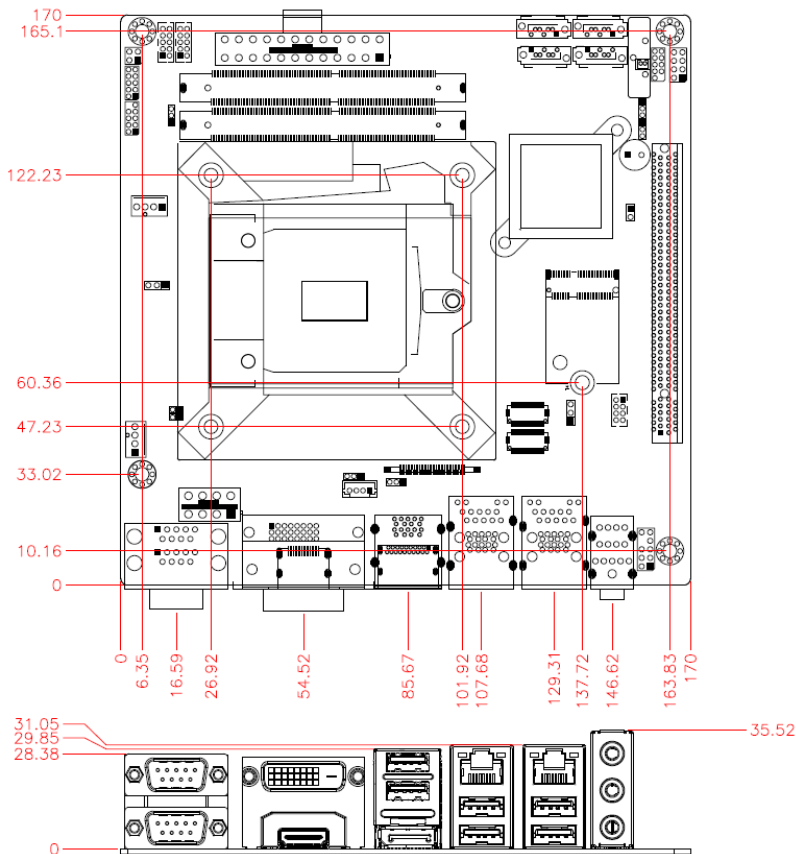

This page is intentionally left blank.

Chapter 2

Hardware Configuration

This section provides information on jumper settings and connectors on the board in order to set up a workable system. On top of that, you will also need to install crucial pieces such as the CPU and the memory before using the product. The topics covered are:

- Essential installations before you begin:
CPU and the memory
- Jumper and connector locations
- Jumper settings and information of connectors

2.1 Installations

2.1.1 Installing the CPU

1. Unlock the CPU socket by pressing the lever sideways, then lift up the lever and the metal lid.
2. Position the CPU above the socket such that the CPU corner aligns with the gold triangle matching the socket corner with a small triangle.

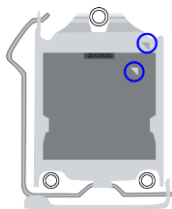

3. Carefully insert the CPU into the socket and push down the lever to secure the CPU.

Then install the CPU cooler and fan back.

Note: Ensure that the CPU cooler and the CPU top surface are in total contact to avoid CPU overheating problem that would cause your system to hang or be unstable.

2.1.2 Installing the Memory

To install the modules, locate the memory slot on the board and perform the following steps.

1. Press the ejector tab of the memory slot outwards with your fingertips.



2. Hold the memory module and align the key of the module with that on the memory slot.
3. Gently push the module in an upright position until the ejector tabs of the memory slot close to hold the module in place when the module touches the bottom of the slot.

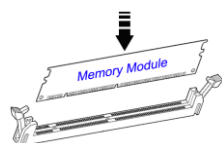

To remove the module, press the ejector tabs outwards with your fingertips to eject the module.

2.2 Setting the Jumpers

Set up and configure your product by using jumpers for various settings and features according to your needs and applications. Contact your supplier if you have doubts about the best configuration for your use.

2.2.1 How to Set Jumpers

Jumpers are short-length conductors consisting of several metal pins with a non-conductive base mounted on the circuit board. Jumper caps are used to have the functions and features enabled or disabled. If a jumper has 3 pins, you can connect either PIN1 to PIN2 or PIN2 to PIN3 by shorting.

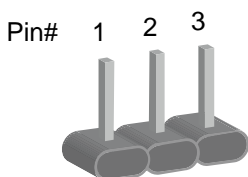

A 3-pin jumper

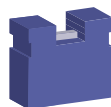

A jumper cap

Refer to the illustration below to set jumpers.

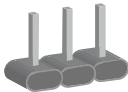
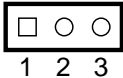
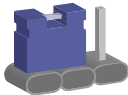
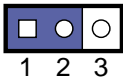
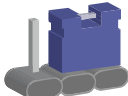
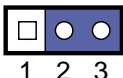
Pin closed	Oblique view	Schematic illustration in the manual
Open		 1 2 3
1-2		 1 2 3
2-3		 1 2 3

When two pins of a jumper are encased in a jumper cap, this jumper is **closed**, i.e. turned **On**.

When a jumper cap is removed from two jumper pins, this jumper is **open**, i.e. turned **Off**.

2.3 Jumper & Connector Locations on MI998

MI998AF:

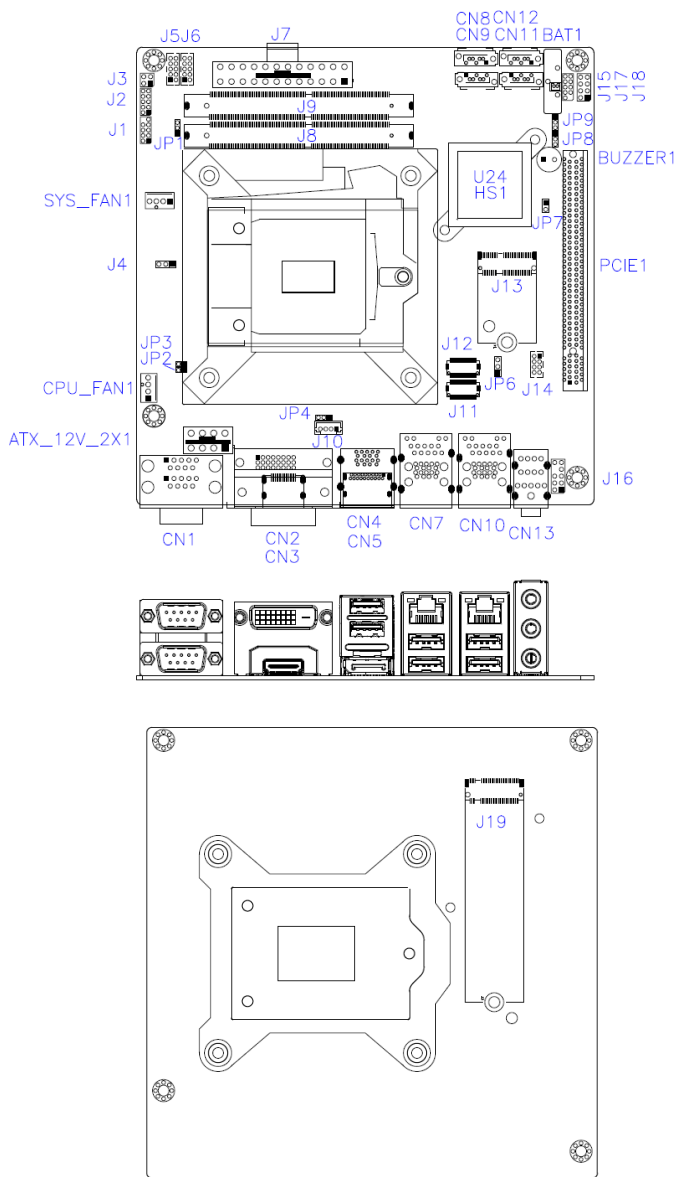

Figures of MI998AF

MI998EF:

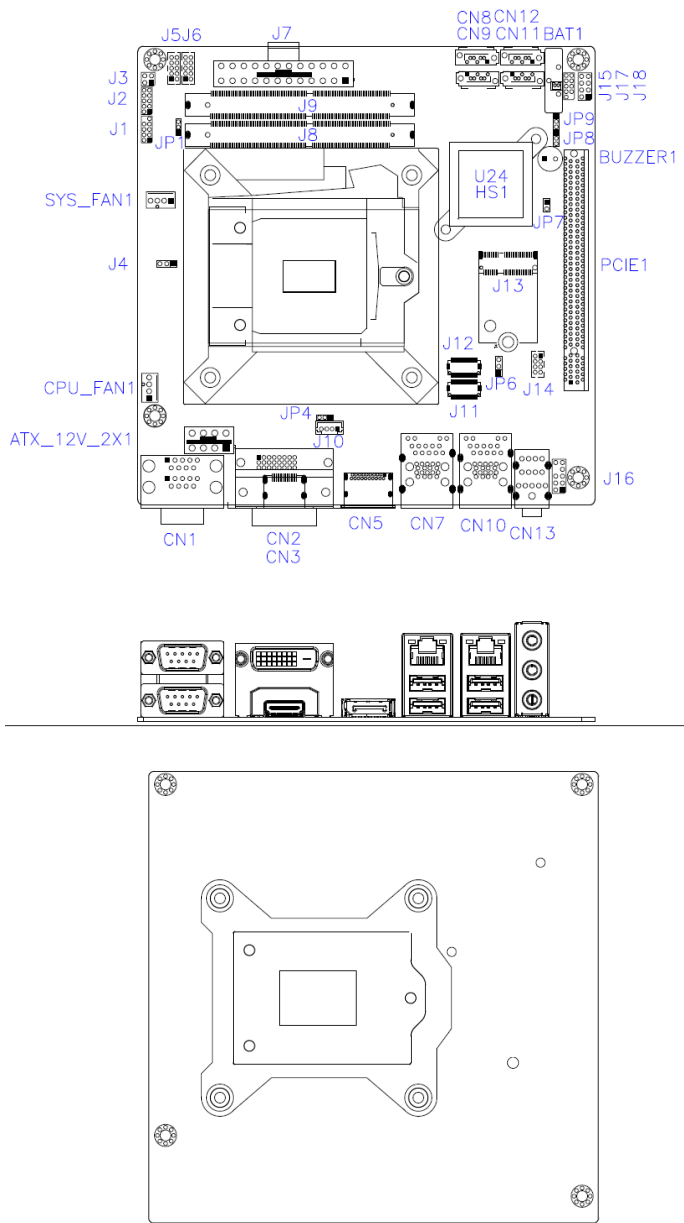

Figures of MI998EF

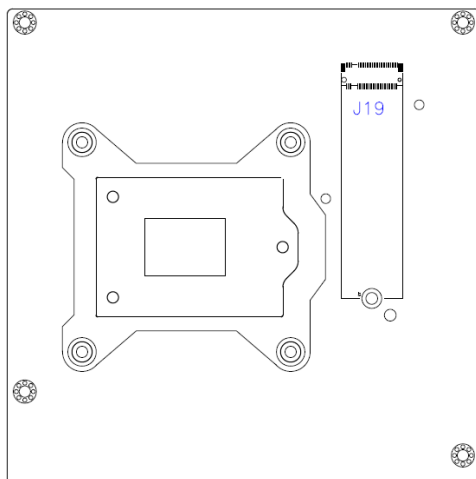
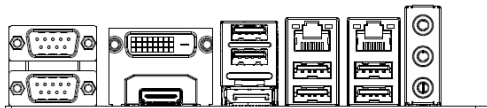
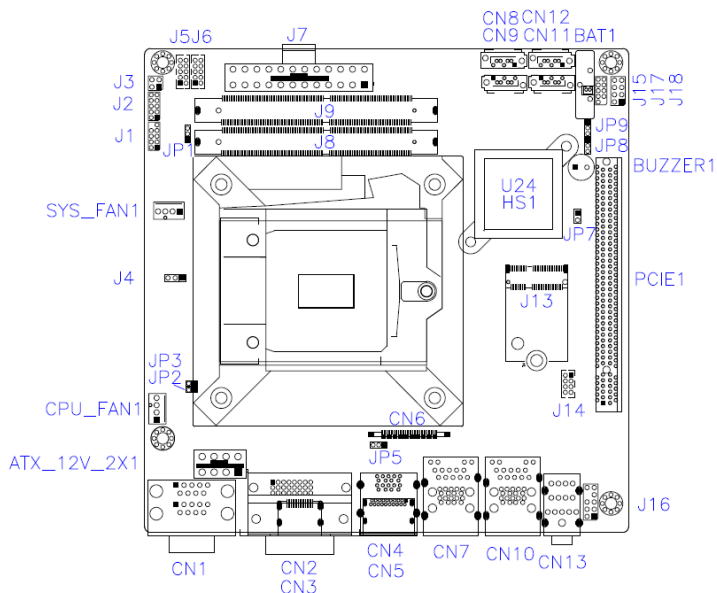

Figures of MI998AFE

MI998EFE:

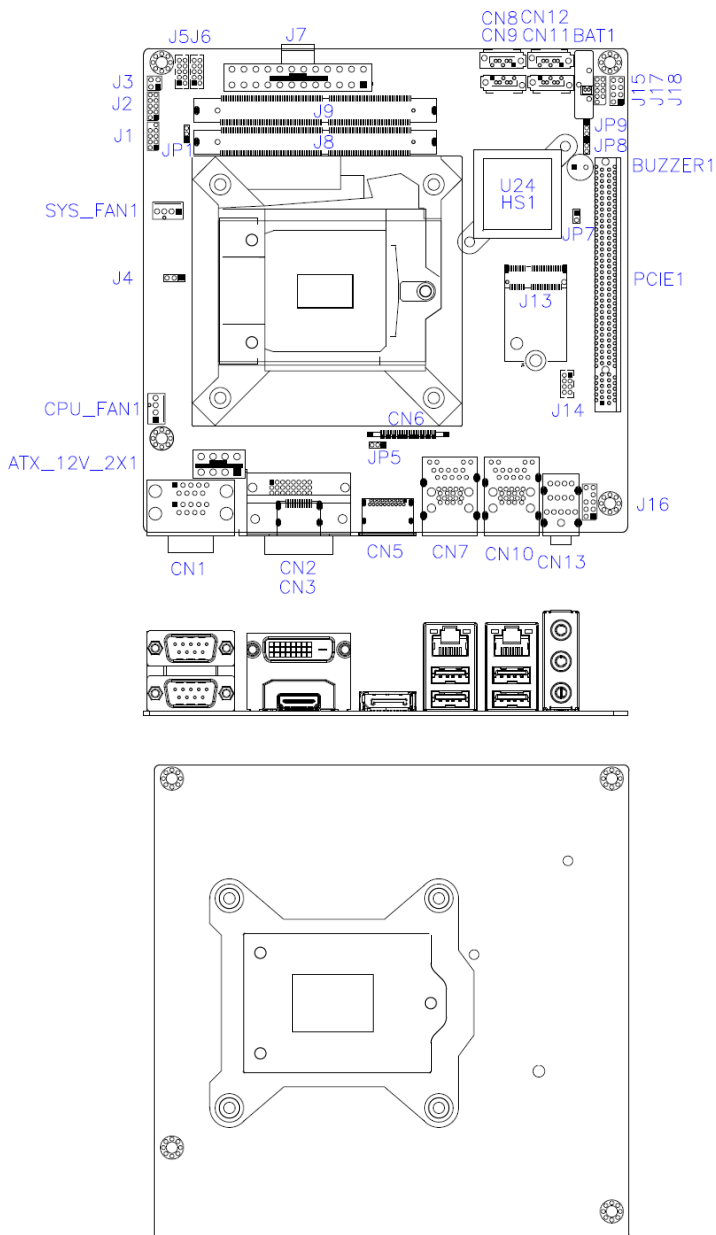

Figure of MI998EFE

2.4 Jumpers Quick Reference

Function	Jumper Name	Page
eDP Panel Power Selection	JP5	18
Clearing CMOS Data	JP9	19
Clearing ME Register	JP8	20
ATX & AT Power Mode Select	JP1	21
LVDS Panel Brightness Selection	JP4	22
LVDS Panel Power Selection	JP6	23
PCIe Bifurcation Selection	JP2, JP3	24
Factory Use Only	JP7	--

Note: The board drawings below include all the connectors of different models.

2.4.1 eDP Panel Power Selection (JP5)

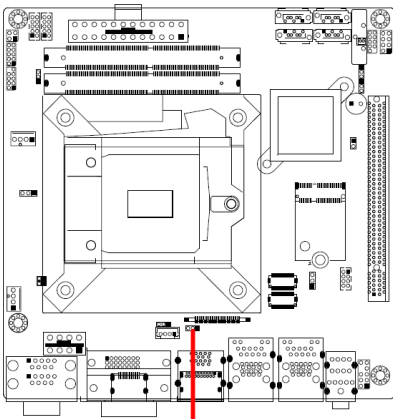

Function	Pin closed	Illustration
3.3V (default)	1-2	1
5V	2-3	1

2.4.2 Clearing CMOS Data (JP9)

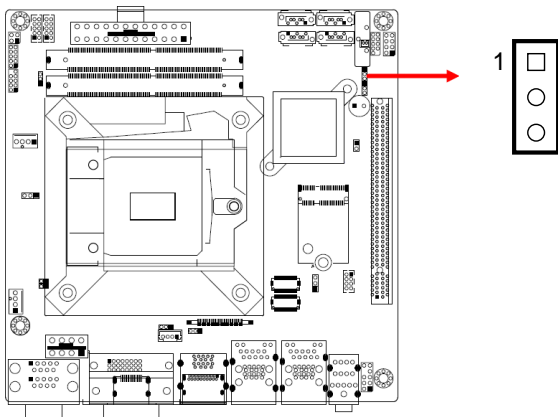

Function	Pin closed	Illustration
Normal (default)	1-2	1
Clear CMOS	2-3	1

2.4.3 Clearing ME Register (JP8)

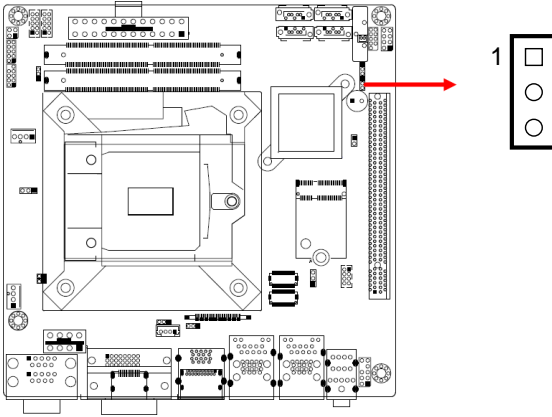

Function	Pin closed	Illustration
Normal (default)	1-2	1
Clear ME	2-3	1

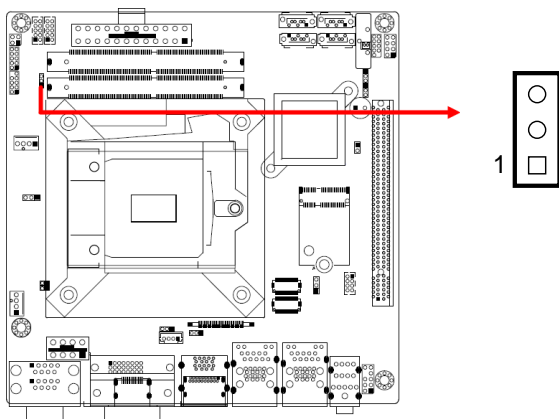

2.4.4 ATX & AT Power Mode Selection (JP1)

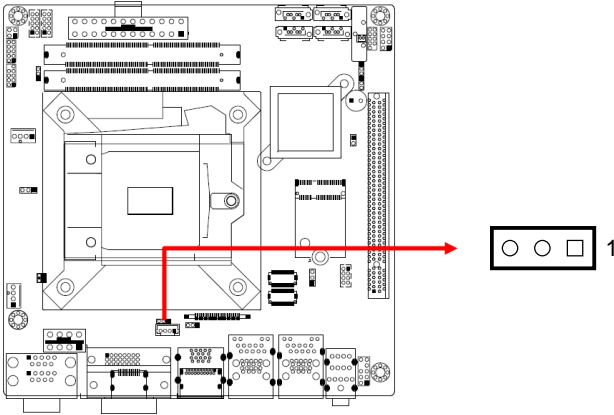

Function	Pin closed	Illustration
ATX Mode (default)	1-2	
AT Mode	2-3	

2.4.5 LVDS Power Brightness Selection (JP4)



Function	Pin closed	Illustration
3.3V (default)	1-2	 1
5V	2-3	 1



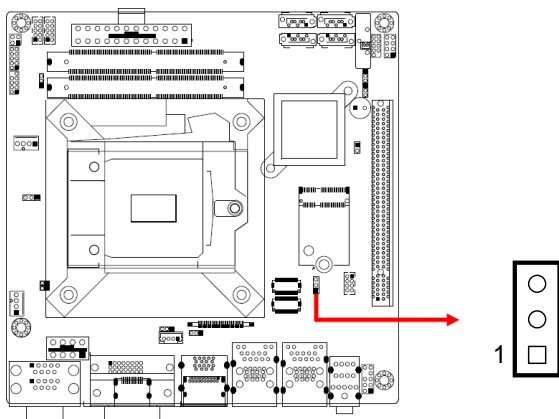



2.4.6 LVDS Panel Power Selection (JP6)

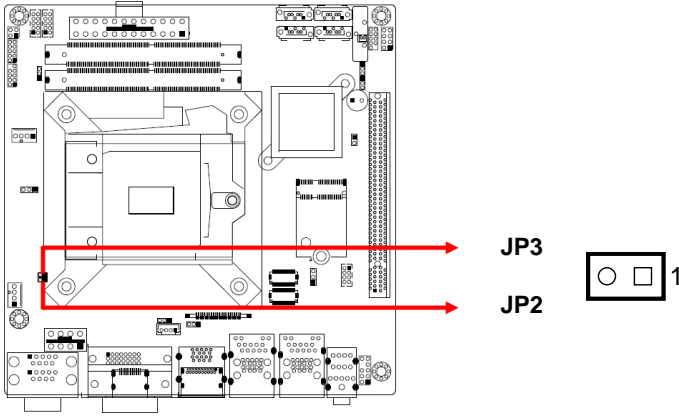

Function	Pin closed	Illustration
3.3V (default)	1-2	
5V	2-3	

2.4.7 PCIe (x16) Bifurcation Selection (JP2 & JP3)



Function	Pin closed	Illustration
1 x PCIe (x16) (default)	JP3: Open	 1
	JP2: Open	 1
2 x PCIe (x8)	JP3: Open	 1
	JP2: Close	 1
1 x PCIe (x8) 2 x PCIe (x4)	JP3: Close	 1
	JP2: Close	 1

2.5 Connectors Quick Reference

Function	Connector Name	Page
COM1 & COM2 RS-232/422/485 Ports	CN1	26
COM3 & COM4 RS-232 Ports	J5 (COM3), J6 (COM4)	27
eDP Connector	CN6	28
Digital I/O Connector	J2	29
LCD Backlight Connector	J10	29
ATX Power Connector	J7	30
ATX 12V Power Connector	ATX_12V_2X1	31
Dual USB 2.0 Connector	J14	31
Front Panel Audio Connector	J16	32
Front Panel Settings Connector	J18	33
LVDS Connector	J11, J12	34
Fan Power Connector	CPU_FAN1, SYS_FAN1	35
RTC Lithium Battery Cell Connector	BAT1	--
DVI-D	CN2	--
HDMI Port	CN3	--
Dual USB 3.1 Ports	CN4	--
DisplayPort	CN5	--
SATA III Port	CN2, CN8, CN9, CN11	--
GbE LAN & Dual USB 3.1 Ports	CN7, CN10	--
DDR4 SO-DIMM Slot	J8, J9	--
M.2 M2280 Slot	J19	--
M.2 E2230 Slot	J13	--
PCIe (x16) Slot	PCIE1	--
Factory Use Only	J1, J4, J17	--

2.5.1 COM1 & COM2 RS-232/422/485 Ports (CN1)

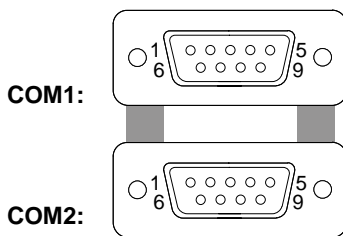
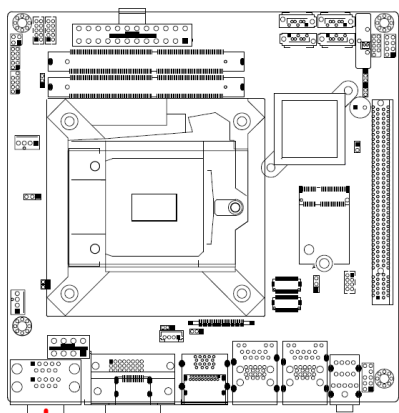

Pin	Signal Name	Pin	Signal Name
1	DCD, Data carrier detect	6	DSR, Data set ready
2	RXD, Receive data	7	RTS, Request to send
3	TXD, Transmit data	8	CTS, Clear to send
4	DTR, Data terminal ready	9	RI, Ring indicator
5	Ground		

Pin	Signal Name		
	RS-232	RS-422	RS-485
1	DCD	TX-	DATA-
2	RX	TX+	DATA+
3	TX	RX+	NC
4	DTR	RX-	NC
5	Ground	Ground	Ground
6	DSR	NC	NC
7	RTS	NC	NC
8	CTS	NC	NC
9	RI	NC	NC

2.5.2 COM3 & COM4 RS-232 Ports (J5, J6)

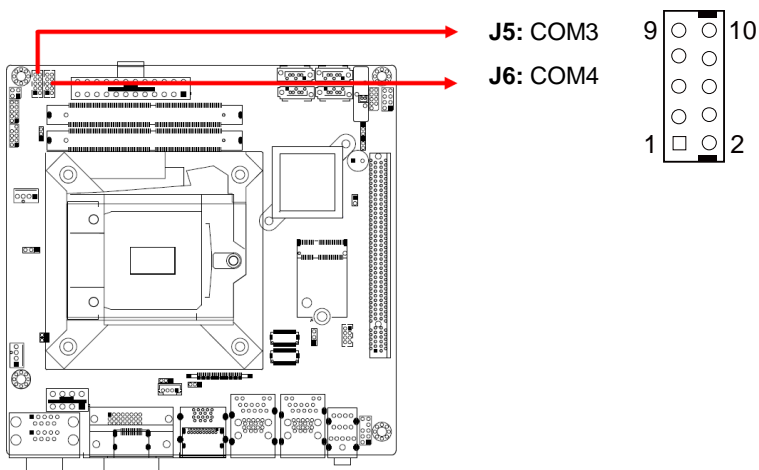

Pin	Signal Name	Pin	Signal Name
1	DCD, Data carrier detect	2	RXD, Receive data
3	TXD, Transmit data	4	DTR, Data terminal ready
5	Ground	6	DSR, Data set ready
7	RTS, Request to send	8	CTS, Clear to send
9	RI, Ring indicator	10	Key

2.5.3 eDP Connector (CN6)

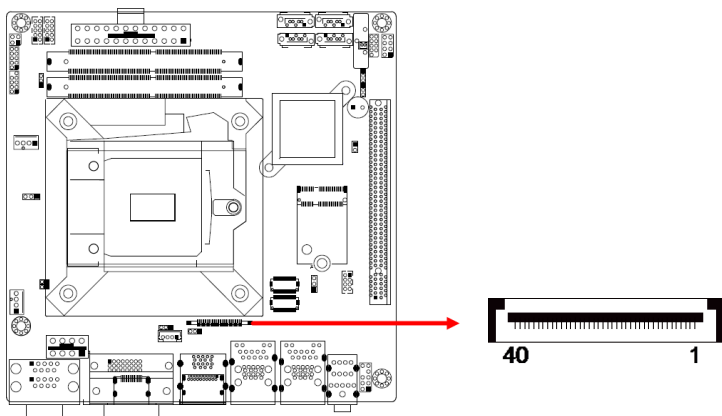

Pin	Signal Name	Pin	Signal Name
1	eDP VCC	21	TXN0
2	eDP VCC	22	TXP0
3	eDP VCC	23	Ground
4	eDP VCC	24	AUXP
5	eDP VCC	25	AUXN
6	Ground	26	X
7	Ground	27	+3.3V
8	Ground	28	+12V
9	Ground	29	X
10	Hot Plug detect	30	Ground
11	Ground	31	+5V
12	NC	32	X
13	NC	33	Back Light Control
14	Ground	34	Back Light Enable
15	NC	35	+12V
16	NC	36	+3.3V
17	Ground	37	Ground
18	TXN1	38	X
19	TXP1	39	X
20	Ground	40	X

2.5.4 Digital I/O Connector (J2)

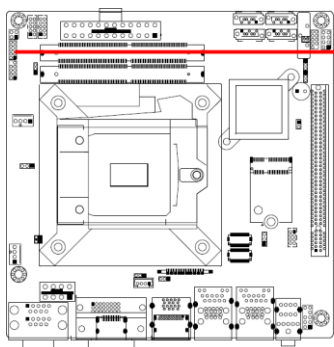

(4-In, 4-Out)

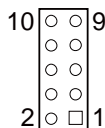

Pin	Signal Name	Pin	Signal Name
1	Ground	2	+5V
3	OUT3	4	OUT1
5	OUT2	6	OUT0
7	IN3	8	IN1
9	IN2	10	IN0

2.5.5 LCD Backlight Connector (J10)

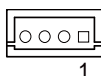
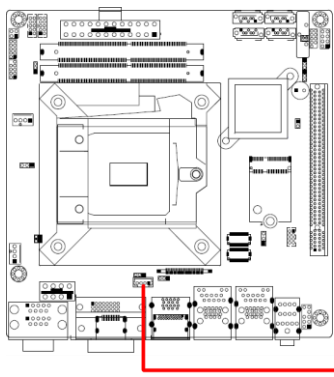

Pin	Signal Name	Pin	Signal Name
1	+12V	3	Brightness Control
2	Backlight Enable	4	Ground

2.5.6 ATX Power Connector (J7)

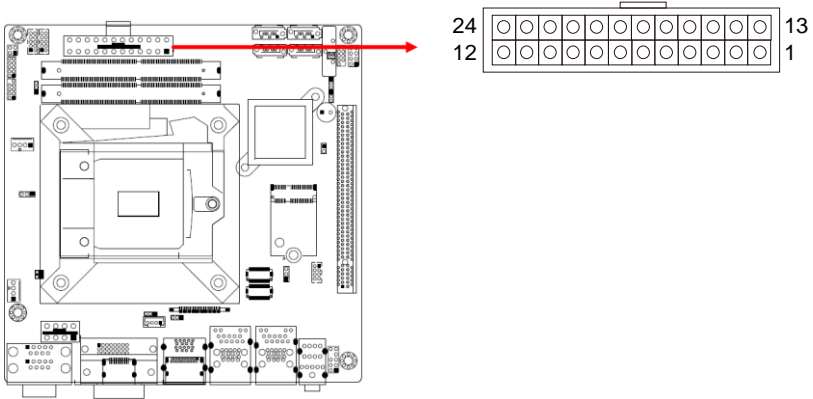

Pin	Signal Name	Pin	Signal Name
1	3.3V	13	3.3V
2	3.3V	14	-12V
3	Ground	15	Ground
4	+5V	16	PS-ON
5	Ground	17	Ground
6	+5V	18	Ground
7	Ground	19	Ground
8	Power good	20	-5V
9	5VSB	21	+5V
10	+12V	22	+5V
11	+12V	23	+5V
12	3.3V	24	Ground

2.5.7 ATX 12V Power Connector (ATX_12V_2x1)

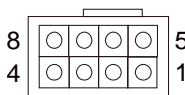
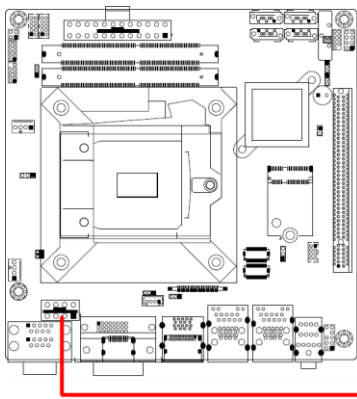

Pin	Signal Name	Pin	Signal Name
1	Ground	5	+12V
2	Ground	6	+12V
3	Ground	7	+12V
4	Ground	8	+12V

2.5.8 Dual USB 2.0 Connector (J14)

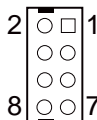
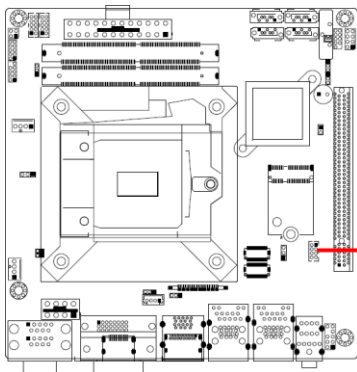

Pin	Signal Name	Pin	Signal Name
1	VCC	2	Ground
3	D0-	4	D1+
5	D0+	6	D1-
7	Ground	8	VCC

2.5.9 Front Panel Audio Connector (J16)

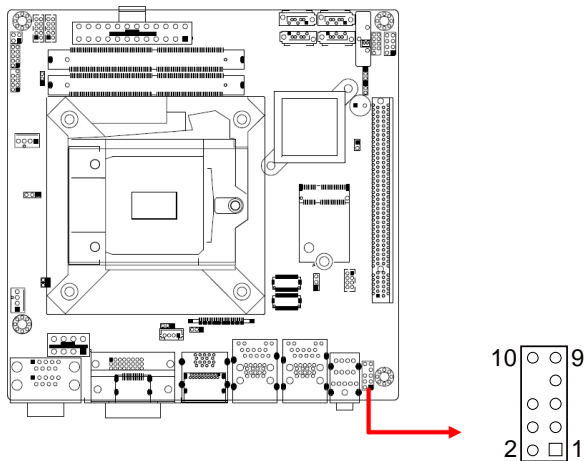

Pin	Signal Name	Pin	Signal Name
1	MIC IN_L	2	Ground
3	MIC IN_R	4	DET
5	LINE_R	6	Ground
7	Sense	8	Key
9	LINE_L	10	Ground

2.5.10 Front Panel Settings Connector (J18)

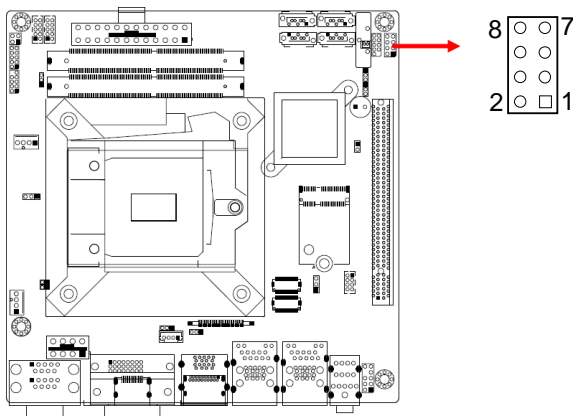

Pin	Signal Name	Pin	Signal Name
1	Power BTN	2	Power BTN
3	HDD LED+	4	HDD LED-
5	Reset BTN	6	Reset BTN
7	Power LED+	8	Power LED-

J18 is utilized for system indicators to provide light indication of the computer activities and switches to change the computer status. It provides interfaces for the following functions.

- **ATX Power ON Switch (Pins 1 and 2)**

The 2 pins makes an “ATX Power Supply On/Off Switch” for the system that connects to the power switch on the case. When pressed, the power switch will force the system to power on. When pressed again, it will power off the system.

- **Hard Disk Drive LED Connector (Pins 3 and 4)**

This connector connects to the hard drive activity LED on control panel. This LED will flash when the HDD is being accessed.

- **Reset Switch (Pins 5 and 6)**

The reset switch allows you to reset the system without turning the main power switch off and then on again. Orientation is not required when making a connection to this header.

- **Power LED (Pins 7 and 8)**

This connector connects to the system power LED on control panel. This LED will light when the system turns on.

2.5.11 LVDS Connector (J11, J12)

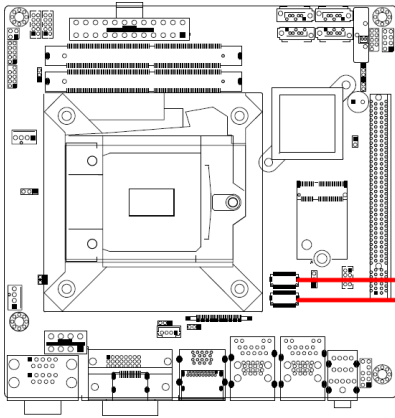

J12: 2nd channel

J11: 1st channel

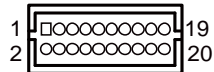

Pin	Signal Name	Pin	Signal Name
1	TX0P	2	TX0N
3	Ground	4	Ground
5	TX1P	6	TX1N
7	Ground	8	Ground
9	TX2P	10	TX2N
11	Ground	12	Ground
13	CLKP	14	CLKN
15	Ground	16	Ground
17	TX3P	18	TX3N
19	VDD	20	VDD

2.5.12 Fan Power Connector (SYS_FAN1, CPU_FAN1)

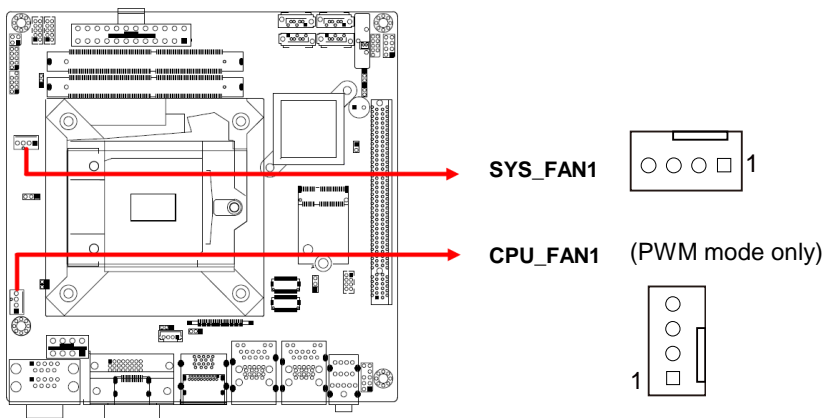

Pin	Signal Name	Pin	Signal Name
1	Ground	3	Rotation detection
2	+12V	4	Control

This page is intentionally left blank.

Chapter 3

Drivers Installation

This chapter introduces installation of the following drivers:

- Intel® Chipset Software Installation Utility
- HD Graphics Driver
- HD Audio Driver
- LAN Driver
- Intel® Management Engine Drivers Installation

3.1 Introduction

This section describes the installation procedures for software and drivers. The software and drivers are included with the motherboard. If you find anything missing, please contact the distributor where you made the purchase. The contents of this section include the following:

Note:

1. After installing your operating system, you must install the Intel® Chipset Software Installation Utility first before proceeding with the drivers installation.
 2. Drivers are supported under Microsoft Windows 10 64-bit (RS3/RS4/RS5) and Server 2016 (RS1) only.
-

3.2 Intel® Chipset Software Installation Utility

The Intel® Chipset drivers should be installed first before the software drivers to install INF files for Plug & Play function for Intel chipset components. Follow the instructions below to complete the installation.

1. Insert the disk enclosed in the package with the board. Click **Intel** on the left pane and then **Intel(R) Coffeelake Chipset Drivers** on the right pane.



2. Click **Intel(R) Chipset Software Installation Utility**.



3. When the *Welcome* screen to the Intel® Chipset Device Software appears, click **Next** to continue.
4. Accept the software license agreement and proceed with the installation process.
5. On the *Readme File Information* screen, click **Install** for installation.
6. When the driver is completely installed, restart the computer for changes to take effect.

3.3 HD Graphics Driver Installation

1. Click **Intel(R) Coffeelake Chipset Drivers** on the right pane.



2. Click **Intel(R) HD Graphics Driver**.

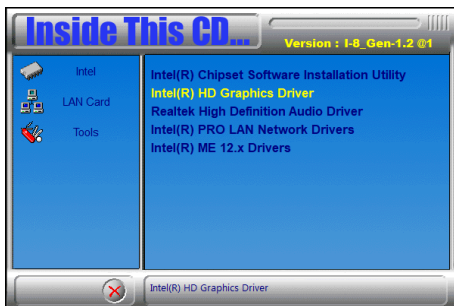

- When the *Welcome* screen appears, click **Next** to continue.

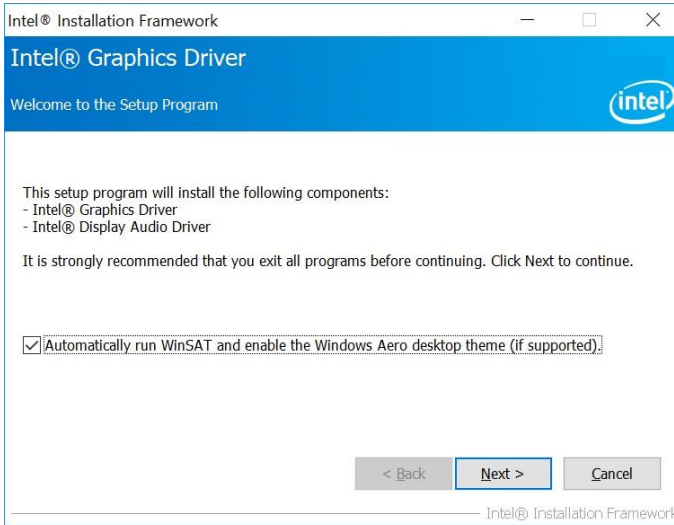

- Accept the license agreement and click **Next**.
- On the *Readme File Information* screen, click **Next** until the installation starts.
- When the driver is completely installed, restart the computer for changes to take effect.

3.4 HD Audio Driver Installation

- Click **Intel(R) Coffeelake Chipset Drivers** on the right pane.



2. Click **Realtek High Definition Audio Driver**.

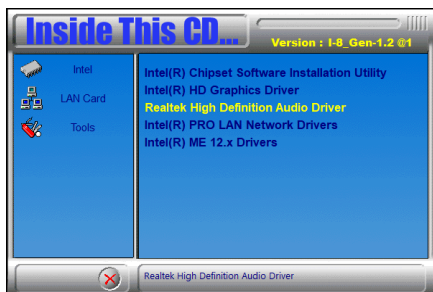

3. On the *Welcome* screen of the InstallShield Wizard, click **Next**.
4. Click **Next** until the installation starts.
5. When the driver is completely installed, restart the computer for changes to take effect.

3.5 LAN Driver Installation

1. Click **Intel(R) Coffeelake Chipset Drivers** on the right pane.



2. Click **Intel(R) PRO LAN Network Drivers**.

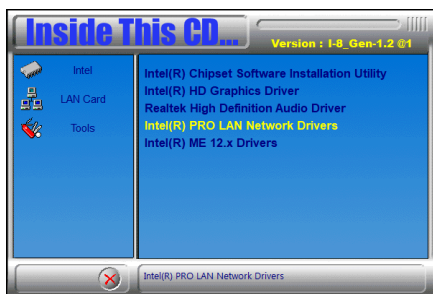

- When the *Welcome* screen appears, click **Next**.

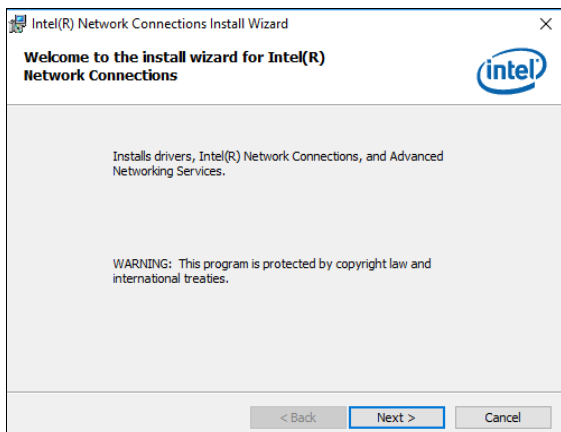

- Accept the license agreement and click **Next**.
- On the *Setup Options* screen, click the checkbox to select the desired driver(s) for installation. Then click **Next** to continue.

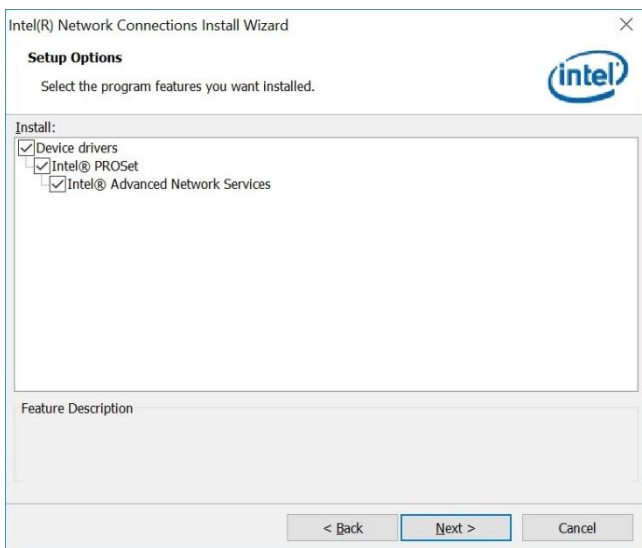

- The wizard is ready for installation. Click **Install**.
- As the installation is complete, restart the computer for changes to take effect.

3.6 Intel® Management Engine Drivers Installation

1. Click **Intel(R) Coffeelake Chipset Drivers** on the right pane.



2. Click **Intel(R) ME 12.x Drivers**.



3. When the *Welcome* screen appears, click **Next**.



4. Accept the license agreement, choose a destination folder and click **Next** until the installation starts.
5. As the installation is complete, restart the computer for changes to take effect.

Chapter 4

BIOS Setup

This chapter describes the different settings available in the AMI BIOS that comes with the board. The topics covered in this chapter are as follows:

- Main Settings
- Advanced Settings
- Chipset Settings
- Boot Settings
- Security Settings
- Save & Exit

4.1 Introduction

The BIOS (Basic Input/Output System) installed in the ROM of your computer system supports Intel® processors. The BIOS provides critical low-level support for standard devices such as disk drives, serial ports and parallel ports. It also provides password protection as well as special support for detailed fine-tuning of the chipset controlling the entire system.

4.2 BIOS Setup

The BIOS provides a Setup utility program for specifying the system configurations and settings. The BIOS ROM of the system stores the Setup utility. When you turn on the computer, the BIOS is immediately activated. Pressing the key immediately allows you to enter the Setup utility. If you are a little bit late pressing the key, POST (Power On Self Test) will continue with its test routines, thus preventing you from invoking the Setup. You can also press <F7> to have the Boot menu pop up immediately.

If you still need to enter Setup, restart the system by pressing the "Reset" button or simultaneously pressing the <Ctrl>, <Alt> and <Delete> keys. You can also restart by turning the system Off and back On again.

The following message will appear on the screen:

```
Press <DEL> to Enter Setup
```

In general, press the arrow keys to highlight items, <Enter> to select, the <PgUp> and <PgDn> keys to change entries, <F1> for help, and <Esc> to quit.

When you enter the BIOS Setup utility, the *Main Menu* screen will appear on the screen. The Main Menu allows you to select from various setup functions and exit choices.

Warning: It is strongly recommended that you avoid making any changes to the chipset defaults.

These defaults have been carefully chosen by both AMI and your system manufacturer to provide the absolute maximum performance and reliability. Changing the defaults could make the system unstable and crash in some cases.

4.3 Main Settings

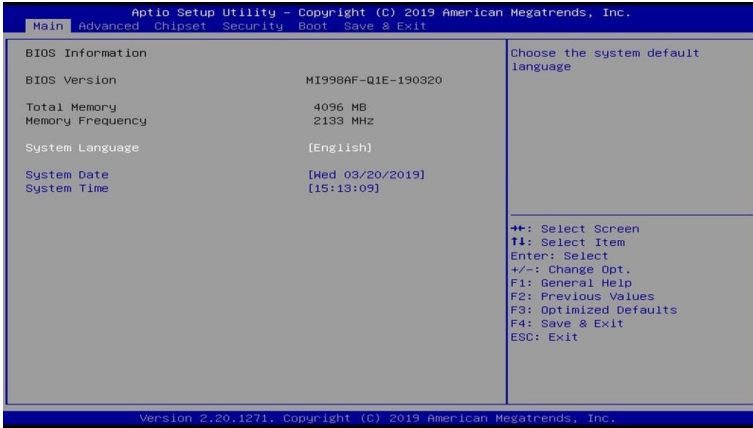

BIOS Setting	Description
System Language	Chooses the system default language.
System Date	Sets the date. Use the <Tab> key to switch between the data elements.
System Time	Set the time. Use the <Tab> key to switch between the data elements.

4.4 Advanced Settings

This section allows you to configure, improve your system and allows you to set up some system features according to your preference.

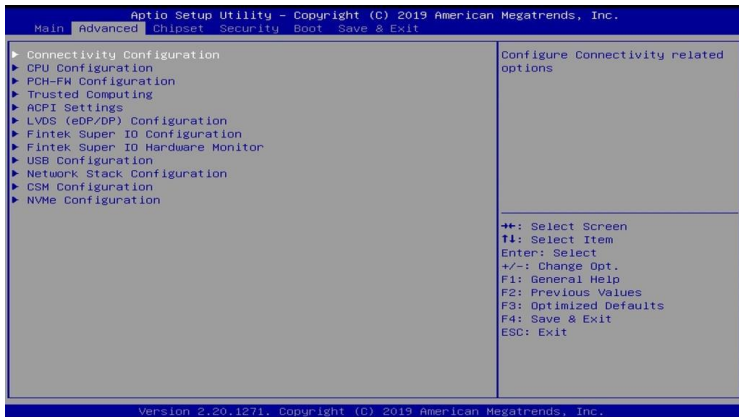

BIOS Setting	Description
Connectivity Configuration	Configures connectivity related options.
CPU Configuration	Displays CPU configuration parameters.
PCH-FW Configuration	Configures management engine technology parameters.
Trusted Computing*	Trusted computing settings.
ACPI Settings	Displays system ACPI parameters.
LVDS (eDP/DP) Configuration ^[1]	Configures LVDS (eDP/DP).
Fintek Super IO Configuration	Displays super IO chip parameters.
Fintek Super IO Hardware Monitor	Shows super IO monitor hardware status.
USB Configuration	Displays USB configuration parameters.
Network Stack Configuration	Network Stack settings.
CSM Configuration	Enables / Disables option ROM execution settings, etc.
NVMe Configuration ^[2]	NVMe device option settings.

[1]: LVDS (eDP/DP) Configuration is available for MI998AF series and MI998EF.

[2]: NVMe Configuration is available for MI998AF series only.

4.4.1 Connectivity Configuration

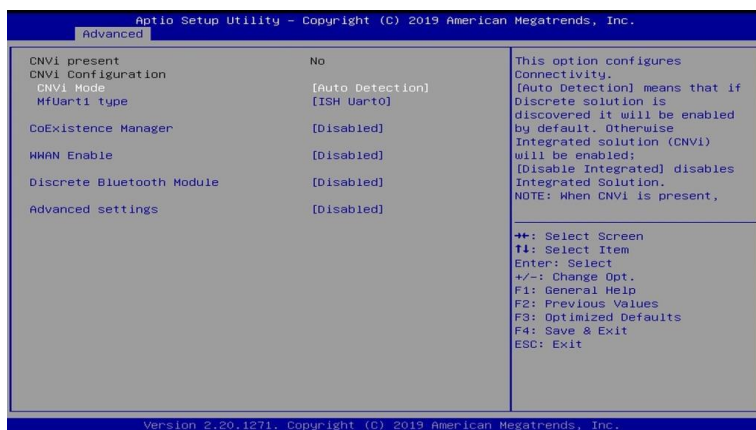

BIOS Setting	Description
CNV1 Mode	This option configures connectivity. Auto Detection means that if Discrete solution is discovered it will be enabled by default. Otherwise Integrated solution (CNV1) will be enabled. Disable Integrated disables
MfUart1 type	This is a test option which allows configuration of UART type for WiFi side band communication. Options: ISH UART0, SerialIO UART2, UART over external pads, Not connected
CoExistence Manager	CoEx Manager mitigates radio coexistence issues between Intel WWAN (modem) and Intel WLAN (WiFi/BT). This should be enabled only if both WWAN and WLAN solution are based on Intel components.
WWAN Enable	Enables / Disables M.2 WWAN module. WWAN can only be enabled for re-work boards.
Discrete Bluetooth Module	Serial I/O UART0 needs to be enabled to select BT module.
Advanced settings	Configures ACPI objects for wireless devices.

4.4.2 CPU Configuration

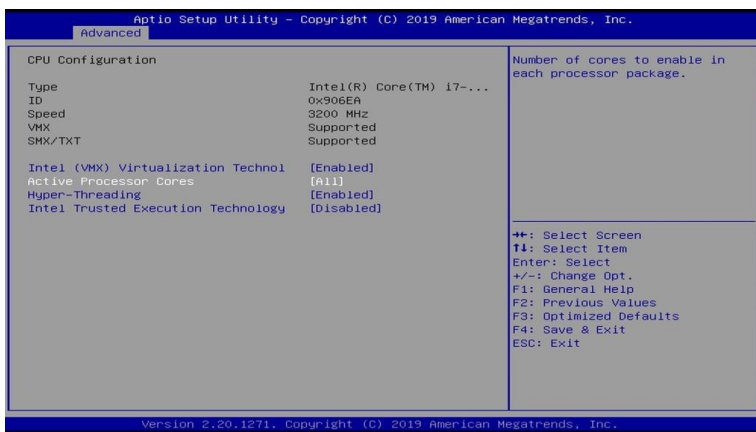

BIOS Setting	Description
Intel (VMX) Virtualization Technology	Enables / Disables a VMM to utilize the additional hardware capabilities provided by Vanderpool Technology.
Active Processor Cores	Number of cores to enable in each processor package. Options: All, 1, 2, 3, 4, 5
Hyper-Threading	Enabled for Windows XP and Linux (OS optimized for Hhyper-Threading Technology) and Disabled for other OS (OS not optimized for Hyper-Threading Technology).
Intel Trusted Execution Technology	Enables / Disables utilization of additional hardware capabilities provided by Intel(R) Trusted Execution Technology. Changes require a full power cycle to take effect.

4.4.3 PCH-FW Configuration

Displays the ME firmware information.

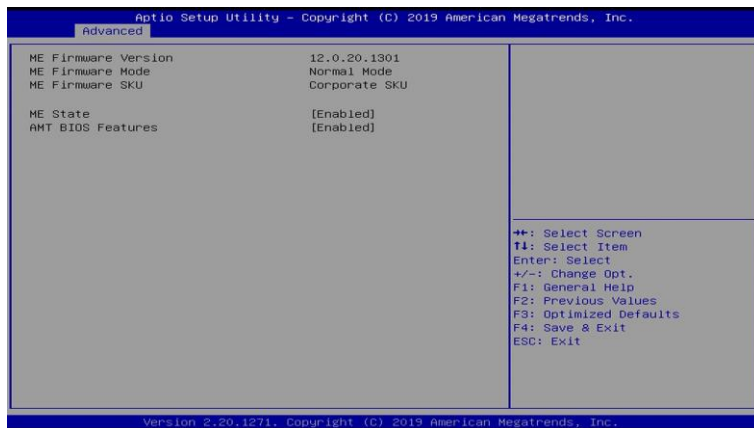

4.4.4 Trusted Computing

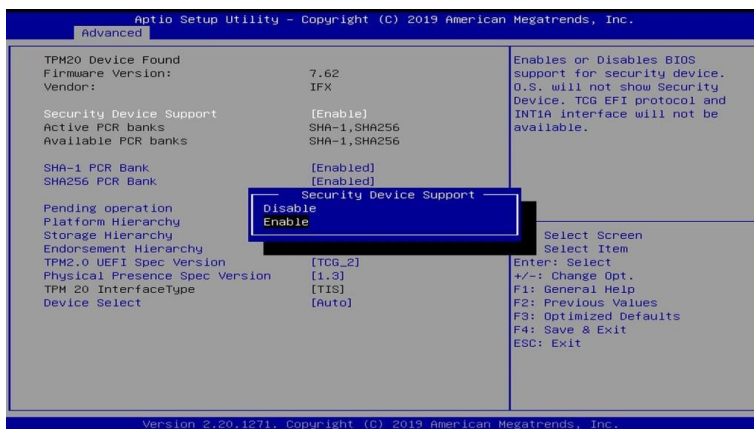

BIOS Setting	Description
Security Device Support	Enables / Disables BIOS support for security device. OS will not show security device. TCG EFI protocol and INTIA interface will not be available.
SHA-1 PCR Bank	Enables / Disables SHA-1 PCR Bank.

BIOS Setting	Description
SHA256 PCR Bank	Enables / Disables SHA256 PCR Bank.
Pending operation	Schedule an operation for the security device. Note: Your computer will reboot during restart in order to change state of security device.
Platform Hierarchy	Enables / Disables platform hierarchy.
Storage Hierarchy	Enables / Disables storage hierarchy.
Endorsement Hierarchy	Enables / Disables endorsement hierarchy.
TPM2.0 UEFI Spec Version	Selects the supported TCG version based on your OS. <ul style="list-style-type: none"> • TCG_1_2: supports Windows 8 /10. • TCG_2: supports new TCG2 protocol and event format for Windows 10 or later.
Physical Presence Spec Version	Selects to show the PPI Spec Version (1.2 or 1.3) that the OS supports. Note: Some HCK tests might not support 1.3.
Device Select	<ul style="list-style-type: none"> • TPM 1.2 will restrict support to TPM 1.2 devices only. • TPM 2.0 will restrict support to TPM 2.0 devices only. • Auto will support both with the default being set to TPM 2.0 devices if not found, and TPM 1.2 device will be enumerated.

4.4.5 ACPI Settings

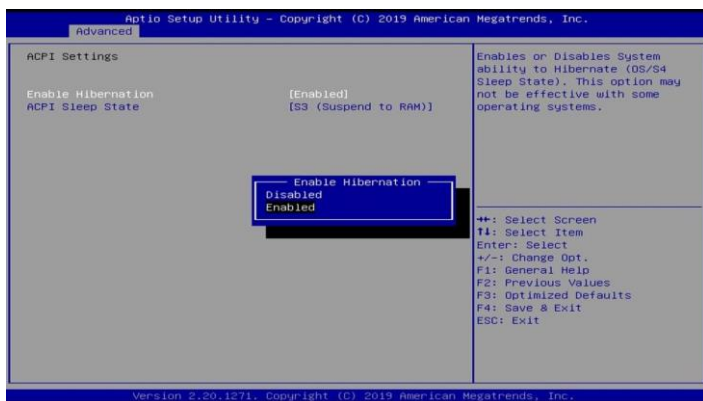

BIOS Setting	Description
Enable Hibernation	Enables / Disables the system ability to hibernate (OS/S4 Sleep State). This option may be not effective with some OS.
ACPI Sleep State	Selects an ACPI sleep state where the system will enter when the Suspend button is pressed. Options: Suspend Disabled, S3 (Suspend to RAM)

4.4.6 LVDS (eDP/DP) Configuration

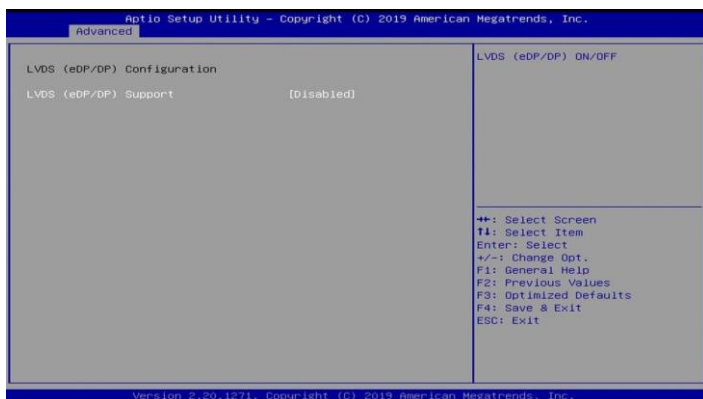

Note: LVDS (eDP/DP) configuration is only available for MI998AF series and MI998EF.

BIOS Setting	Description
LVDS (eDP/DP) Support	Enables / Disables LVDS (eDP/DP).

4.4.7 Fintek Super IO Configuration

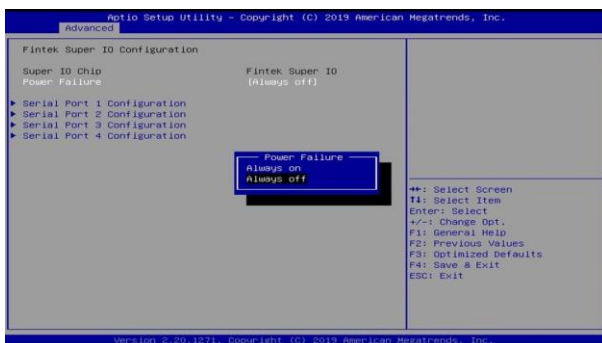

BIOS Setting	Description
Standby Power On S5 (ERP)	Enables / Disables the standby power. * Available for MI998EF only.
Power Failure	Options: Always on, Always off
Serial Port Configuration	Sets parameters of Serial Ports. Enables / Disables the serial port and select an optimal setting for the Super IO device.

4.4.7.1. Serial Port 1 Configuration



BIOS Setting	Description
Serial Port	Enables / Disables the serial port.
Change Settings	Selects an optimal settings for Super I/O device. <ul style="list-style-type: none"> Auto IO = 3F8h; IRQ = 4 IO = 3F8h; IRQ = 3, 4, 5, 6, 7, 9, 10, 11, 12 IO = 2F8h; IRQ = 3, 4, 5, 6, 7, 9, 10, 11, 12 IO = 3E8h; IRQ = 3, 4, 5, 6, 7, 9, 10, 11, 12 IO = 2E8h; IRQ = 3, 4, 5, 6, 7, 9, 10, 11, 12

BIOS Setting	Description
Device Mode	Changes the serial port mode to RS-232 / RS-422 / RS-485. <ul style="list-style-type: none"> • RS232 • RS485 TX Low Active • RS485 with Termination TX Low Active • RS422 • RS422 with Termination

4.4.7.2. Serial Port 2 Configuration



BIOS Setting	Description
Serial Port	Enables / Disables the serial port.
Change Settings	Selects an optimal settings for Super I/O device. Options: <ul style="list-style-type: none"> • Auto • IO = 2F8h; IRQ = 3 • IO = 3F8h; IRQ = 3, 4, 5, 6, 7, 9, 10, 11, 12 • IO = 2F8h; IRQ = 3, 4, 5, 6, 7, 9, 10, 11, 12 • IO = 3E8h; IRQ = 3, 4, 5, 6, 7, 9, 10, 11, 12 • IO = 2E8h; IRQ = 3, 4, 5, 6, 7, 9, 10, 11, 12
Device Mode	Changes the serial port mode to RS-232 / RS-422 / RS-485. Options: <ul style="list-style-type: none"> • RS232 • RS485 TX Low Active • RS485 with Termination TX Low Active • RS422 • RS422 with Termination

4.4.7.3. Serial Port 3 Configuration



BIOS Setting	Description
Serial Port	Enables / Disables the serial port.
Change Settings	Selects an optimal settings for Super I/O device. <ul style="list-style-type: none"> • Auto • IO = 3E8h; IRQ = 7 • IO = 3E8h; IRQ = 3, 4, 5, 6, 7, 9, 10, 11, 12 • IO = 2E8h; IRQ = 3, 4, 5, 6, 7, 9, 10, 11, 12 • IO = 2F0h; IRQ = 3, 4, 5, 6, 7, 9, 10, 11, 12 • IO = 2E0h; IRQ = 3, 4, 5, 6, 7, 9, 10, 11, 12

4.4.7.4. Serial Port 4 Configuration

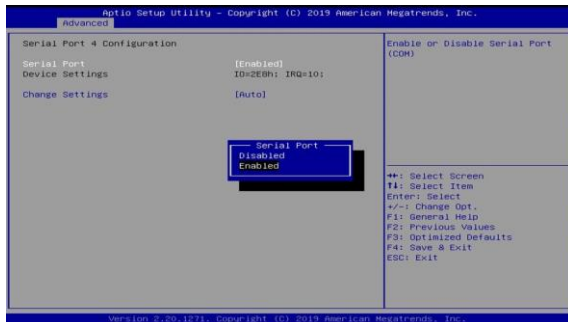

Note: Serial Port 4 is available for MI998AF series only.

BIOS Setting	Description
Serial Port	Enables / Disables the serial port.
Change Settings	Selects an optimal settings for Super I/O device. <ul style="list-style-type: none"> • Auto • IO = 2E8h; IRQ = 7 • IO = 3E8h; IRQ = 3, 4, 5, 6, 7, 9, 10, 11, 12 • IO = 2E8h; IRQ = 3, 4, 5, 6, 7, 9, 10, 11, 12 • IO = 2F0h; IRQ = 3, 4, 5, 6, 7, 9, 10, 11, 12 • IO = 2E0h; IRQ = 3, 4, 5, 6, 7, 9, 10, 11, 12

4.4.8 Fintek Super IO Hardware Monitor

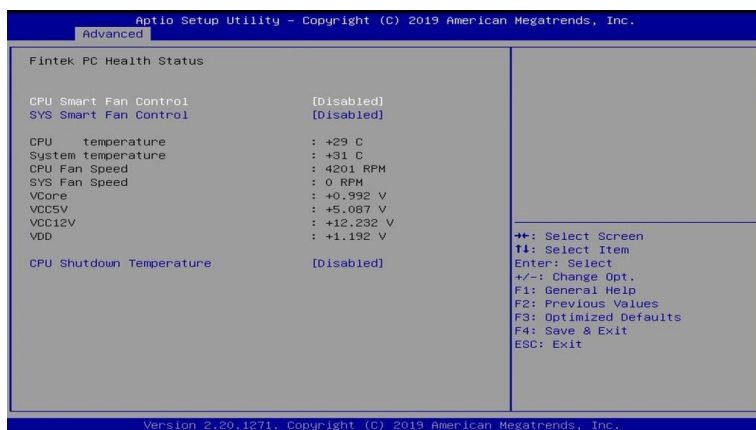

BIOS Setting	Description
CPU Smart Fan Control	Enables / Disables the CPU smart fan feature. Options: Disabled / 50 °C / 60 °C / 70 °C / 80 °C
System Smart Fan Control	Enables / Disables the system smart fan feature. Options: Disabled / 50 °C / 60 °C / 70 °C / 80 °C
Temperatures / Voltages	These fields are the parameters of the hardware monitoring function feature of the motherboard. The values are read-only values as monitored by the system and show the PC health status.
CPU Shutdown Temperature	Options: Disabled / 70 °C / 75 °C / 80 °C / 85 °C / 90 °C / 95 °C

4.4.9 USB Configuration

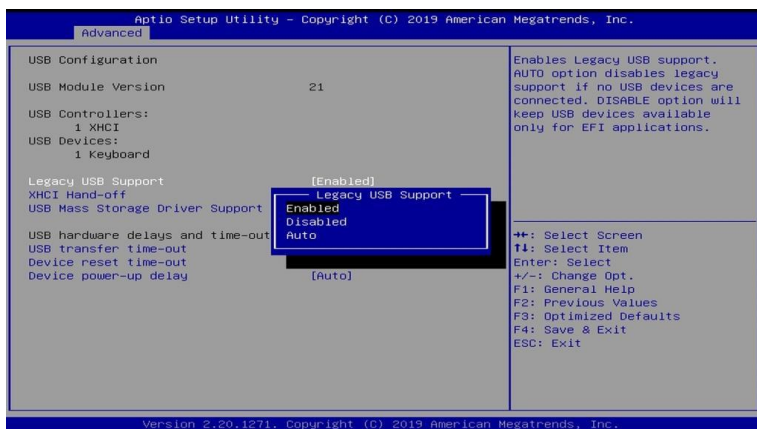

BIOS Setting	Description
Legacy USB Support	<p>Enables Legacy USB support.</p> <ul style="list-style-type: none"> Auto disables legacy support if there is no USB device connected. Disable keeps USB devices available only for EFI applications.
XHCI Hand-off	<p>This is a workaround for OSES without XHCI hand-off support. The XHCI ownership change should be claimed by XHCI driver.</p>
USB Mass Storage Driver Support	<p>Enables / Disables the support for USB mass storage driver.</p>
USB Transfer time-out	<p>The time-out value for control, bulk, and Interrupt transfers.</p> <p>Options: 1 sec / 5 sec / 10 sec / 20 sec</p>
Device reset time-out	<p>Seconds of delaying execution of start unit command to USB mass storage device.</p> <p>Options: 10 sec / 20 sec / 30 sec / 40 sec</p>
Device power-up delay	<p>The maximum time the device will take before it properly reports itself to the Host Controller.</p> <p>Auto uses default value for a Root port it is 100ms. But for a Hub port, the delay is taken from Hub descriptor.</p> <p>Options: Auto / Manual</p>

4.4.10 Network Configuration

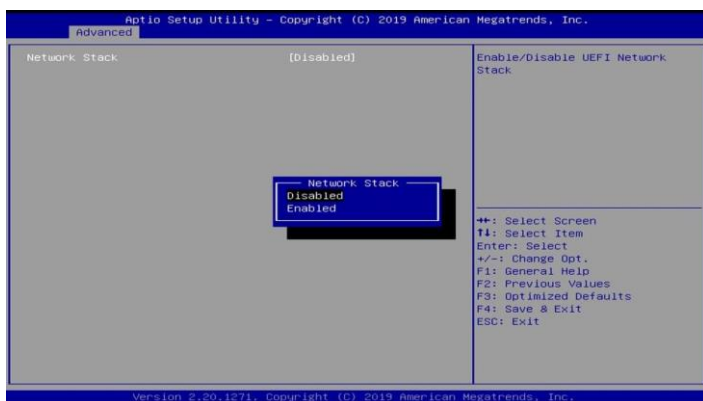

BIOS Setting	Description
Network Stack	Enables / Disables UEFI Network Stack.

4.4.11 CSM Configuration



BIOS Setting	Description
CSM Support	Enables / Disables CSM support.
GateA20 Active	<ul style="list-style-type: none"> • Upon Request disables GA20 when using BIOS services. • Always cannot disable GA20, but is useful when any RT code is executed above 1 MB.

BIOS Setting	Description
INT19 Trap Response	<p>Sets how BIOS reacts on INT19 trap by Option ROM.</p> <ul style="list-style-type: none"> • Immediate executes the trap right away. • Postponed executes the trap during legacy boot.
HDD Connection Order	<p>Some OS require HDD handles to be adjusted, i.e. OS is installed on drive 80h.</p> <p>Options: Adjust, Keep</p>
Boot option filter	<p>Controls the priority of Legacy and UEFI ROMs priority.</p> <p>Options: UEFI and Legacy, Legacy only, UEFI only</p>
Network	<p>Controls the execution of UEFI and Legacy PXE OpROM.</p> <p>Options: Do not launch / Legacy</p>

4.4.12 NVMe Configuration

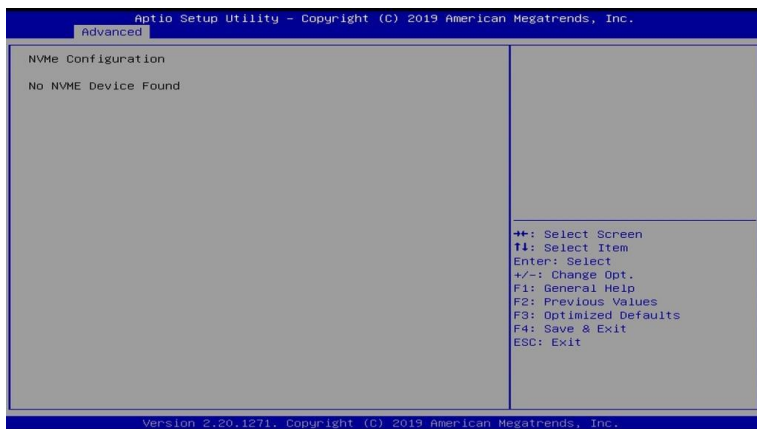

Note: NVMe configuration is only available for MI998AF series and MI998EF.

4.5 Chipset Settings



BIOS Setting	Description
System Agent (SA) Configuration	System Agent (SA) parameters
PCH-IO Configuration	PCH parameters

4.5.1 System Agent (SA) Configuration

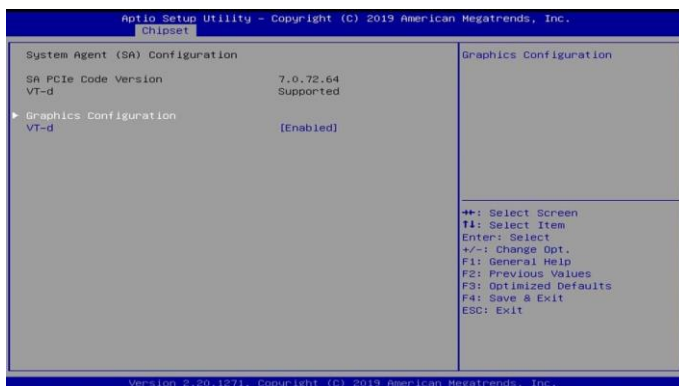

BIOS Setting	Description
Graphics Configuration	Configures the graphics settings.
VT-d	Checks if VT-d function on MCH is supported.

4.5.1.1. Graphics Configuration

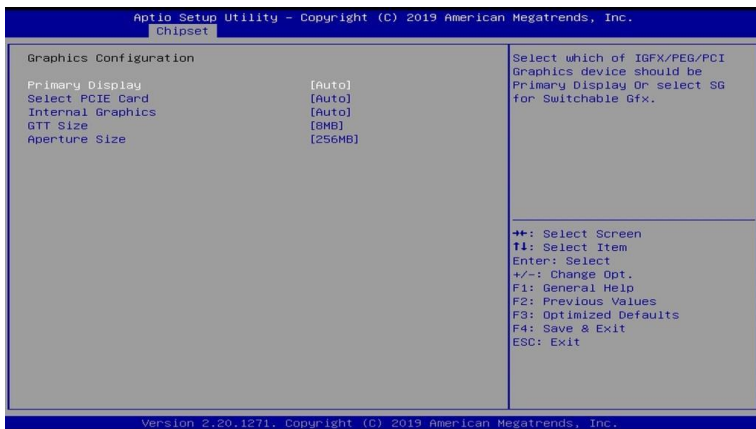

BIOS Setting	Description
Primary Display	Select which of IGFX/PEG/PCI Graphics device should be primary display or select SG for switchable Gfx. Options: Auto, IGFX, PEG, PCI, SG
Select PCIE Card	Selects the card used on the platform. Auto skips GPIO based Power Enable to dGPU. E1k Creek 4: DGPU Power Enable = Active Low. PEG Eva1: DGPU Power Enable = Active High.
Internal Graphics	Keep IGFX enabled based on the setup options. Options: Auto, Disabled, Enabled
GTT Size	Sets the GTT size as 2 MB, 4 MB, or 8 MB.
Aperture Size	Sets the aperture size as 128 MB, 256 MB, 512 MB, 1024 MB or 2048 MB. Note: Above 4 GB MMIO BIOS assignment is automatically enabled when selecting 2048 MB aperture. To use this feature, disable CSM support.

4.5.2 PCH-IO Configuration



BIOS Setting	Description
SATA and RST Configuration	Configures SATA devices.
PCH LAN Controller	Enables / Disables the onboard NIC.
Wake on LAN Enable	Enables / Disables the integrated LAN to wake up the system.
PS_ON Enable	Enables / Disables PS_ON support a new C10 state from the CPU on desktop SKUs that enables a lower power target that will be required by the California Energy commission (CEC).

4.5.2.1. SATA and RST Configuration:



BIOS Setting	Description
SATA Controller(s)	Enables / Disables the SATA device.
SATA Mode Selection	Determines how SATA controller(s) operate. Options: AHCI / Intel RST Premium
Serial ATA Ports	Enables / Disables serial ports.
SATA Ports Hot Plug	Enables / Disables SATA Ports HotPlug.

4.6 Security Settings



BIOS Setting	Description
Administrator Password	Sets an administrator password for the setup utility.
User Password	Sets a user password.
Secure Boot	Configures Secure Boot.

4.6.1 Secure Boot



BIOS Setting	Description
Secure Boot	Secure Boot feature is Active if Secure Boot is enabled. Platform Key (PK) is enrolled and the system is in User mode. The mode change requires platform reset.

BIOS Setting	Description
Secure Boot Mode	Secure Boot mode options: Standard or Custom. In Custom mode, Secure Boot policy variables can be configured by a physically present user without full authentication.
Restore Factory Keys	Forces system to user mode. Install factory default Secure Boot key databases.
Key Management	Enables expert users to modify Secure Boot Policy variables without full authentication.

4.6.1.1. Key Management



BIOS Setting	Description
Factory Key Provision	Install factory default Secure Boot keys after the platform reset and while the system is in Setup mode.
Restore Factory Keys	Forces system to use mode. Install factory default Secure Boot Key databases.
Enroll Efi Image	Allow the image to run in Secure Boot mode. Enroll SHA256 Hash certificate of a PE image into Authorized Signature Database (db).
Restore DB defaults	Restore DB variable to factory defaults.
Secure Boot variable	Enroll factory defaults or load certificates from a file. <ol style="list-style-type: none"> Public key certificate: EFI_SIGNATURE_LIST, EFI_CERT_X509 (DER), EFI_CERT_RSA2048 (bin), EFI_CERT_SHAxxx Authenticated UEFI Variable EFI PE/COFF image (SHA256)

4.7 Boot Settings

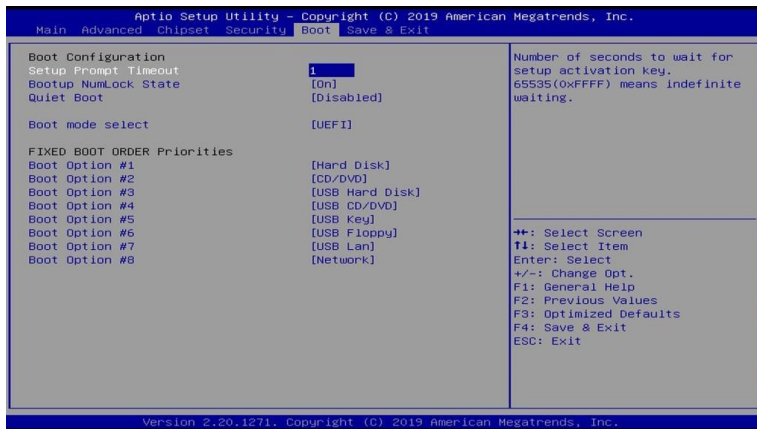

BIOS Setting	Description
Setup Prompt Timeout	Number of seconds to wait for setup activation key. 65535(0xFFFF) means indefinite waiting.
Bootup NumLock State	Selects the keyboard NumLock state.
Quiet Boot	Enables / Disables Quiet Boot option.
Boot mode select	Selects a Boot mode, Legacy / UEFI.
Boot Option Priorities	Sets the system boot order.

4.8 Save & Exit Settings

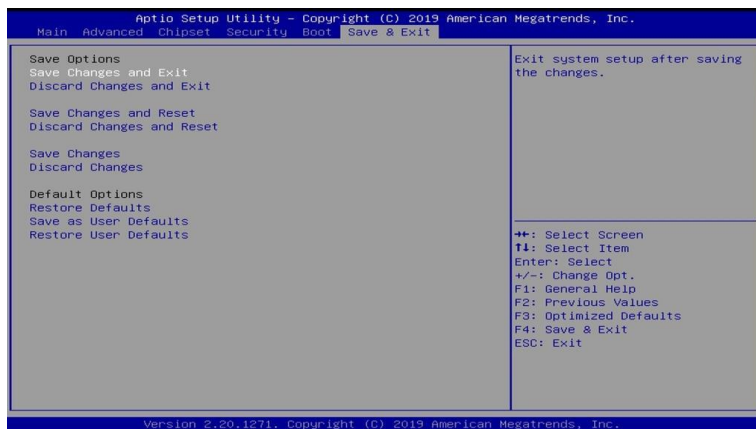

BIOS Setting	Description
Save Changes and Exit	Exits system setup after saving the changes.
Discard Changes and Exit	Exits system setup without saving any changes.
Save Changes and Reset	Resets the system after saving the changes.
Discard Changes and Reset	Resets system setup without saving any changes.
Save Changes	Saves changes done so far to any of the setup options.
Discard Changes	Discards changes done so far to any of the setup options.
Restore Defaults	Restores / Loads defaults values for all the setup options.
Save as User Defaults	Saves the changes done so far as User Defaults.
Restore User Defaults	Restores the user defaults to all the setup options.

Appendix

This section provides the mapping addresses of peripheral devices, the sample code of watchdog timer configuration, and types of on-board connectors.

A. I/O Port Address Map

Each peripheral device in the system is assigned a set of I/O port addresses which also becomes the identity of the device. The following table lists the I/O port addresses used.

Address	Device Description
0x00000A00-0x00000A0F	Motherboard resources
0x00000A10-0x00000A1F	Motherboard resources
0x00000A20-0x00000A2F	Motherboard resources
0x0000002E-0x0000002F	Motherboard resources
0x0000004E-0x0000004F	Motherboard resources
0x00000061-0x00000061	Motherboard resources
0x00000063-0x00000063	Motherboard resources
0x00000065-0x00000065	Motherboard resources
0x00000067-0x00000067	Motherboard resources
0x00000070-0x00000070	Motherboard resources
0x00000080-0x00000080	Motherboard resources
0x00000092-0x00000092	Motherboard resources
0x000000B2-0x000000B3	Motherboard resources
0x00000680-0x0000069F	Motherboard resources
0x0000164E-0x0000164F	Motherboard resources
0x00004000-0x0000403F	Intel(R) UHD Graphics
0x000003F8-0x000003FF	Communications Port (COM1)
0x000002F8-0x000002FF	Communications Port (COM2)
0x000003E8-0x000003EF	Communications Port (COM3)
0x000002E8-0x000002EF	Communications Port (COM4)
0x00001800-0x000018FE	Motherboard resources
0x00000020-0x00000021	Programmable interrupt controller
0x00000024-0x00000025	Programmable interrupt controller
0x00000028-0x00000029	Programmable interrupt controller
0x0000002C-0x0000002D	Programmable interrupt controller
0x00000030-0x00000031	Programmable interrupt controller
0x00000034-0x00000035	Programmable interrupt controller

Address	Device Description
0x00000038-0x00000039	Programmable interrupt controller
0x0000003C-0x0000003D	Programmable interrupt controller
0x000000A0-0x000000A1	Programmable interrupt controller
0x000000A4-0x000000A5	Programmable interrupt controller
0x000000A8-0x000000A9	Programmable interrupt controller
0x000000AC-0x000000AD	Programmable interrupt controller
0x000000B0-0x000000B1	Programmable interrupt controller
0x000000B4-0x000000B5	Programmable interrupt controller
0x000000B8-0x000000B9	Programmable interrupt controller
0x000000BC-0x000000BD	Programmable interrupt controller
0x000004D0-0x000004D1	Programmable interrupt controller
0x00000000-0x00000CF7	PCI Express Root Complex
0x00000D00-0x0000FFFF	PCI Express Root Complex
0x00004090-0x00004097	Standard SATA AHCI Controller
0x00004080-0x00004083	Standard SATA AHCI Controller
0x00004060-0x0000407F	Standard SATA AHCI Controller
0x0000FFF8-0x0000FFFF	Intel(R) Active Management Technology - SOL (COM5)
0x000000F0-0x000000F0	Numeric data processor
0x00002000-0x000020FE	Motherboard resources
0x00000040-0x00000043	System timer
0x00000050-0x00000053	System timer
0x00000060-0x00000060	Standard PS/2 Keyboard
0x00000064-0x00000064	Standard PS/2 Keyboard
0x00001854-0x00001857	Motherboard resources
0x00003000-0x00003FFF	Intel(R) PCI Express Root Port #12 - A333
0x0000EFA0-0x0000EFBF	Intel(R) SMBus - A323

B. Interrupt Request Lines (IRQ)

Peripheral devices use interrupt request lines to notify CPU for the service required. The following table shows the IRQ used by the devices on board.

Level	Function
IRQ 4294967294	Intel(R) PCIe Controller (x16) - 1901
IRQ 4294967288	Intel(R) I210 Gigabit Network Connection
IRQ 4294967287	Intel(R) I210 Gigabit Network Connection
IRQ 4294967286	Intel(R) I210 Gigabit Network Connection
IRQ 4294967285	Intel(R) I210 Gigabit Network Connection
IRQ 4294967284	Intel(R) I210 Gigabit Network Connection
IRQ 4294967283	Intel(R) I210 Gigabit Network Connection
IRQ 4294967282	Intel(R) I210 Gigabit Network Connection
IRQ 4294967281	Intel(R) I210 Gigabit Network Connection
IRQ 4294967280	Intel(R) I210 Gigabit Network Connection
IRQ 4294967279	Intel(R) I210 Gigabit Network Connection
IRQ 4294967290	Intel(R) UHD Graphics
IRQ 4294967289	Intel(R) USB 3.1 eXtensible Host Controller - 1.10 (Microsoft)
IRQ 4	Communications Port (COM1)
IRQ 3	Communications Port (COM2)
IRQ 5	Communications Port (COM3)
IRQ 10	Communications Port (COM4)
IRQ 4294967292	Standard SATA AHCI Controller
IRQ 54 ~ IRQ 204	Microsoft ACPI-Compliant System
IRQ 256 ~ IRQ 511	Microsoft ACPI-Compliant System
IRQ 19	Intel(R) Active Management Technology - SOL (COM5)
IRQ 13	Numeric data processor
IRQ 4294967278	Intel(R) Management Engine Interface
IRQ 0	System timer
IRQ 11	Intel(R) Thermal Subsystem - A379
IRQ 11	Intel(R) SMBus - A323
IRQ 1	Standard PS/2 Keyboard
IRQ 4294967291	Intel(R) Ethernet Connection (7) I219-LM
IRQ 14	Intel(R) Serial IO GPIO Host Controller - INT3450
IRQ 4294967293	Intel(R) PCI Express Root Port #12 - A333
IRQ 16	High Definition Audio Controller

C. Watchdog Timer Configuration

The Watchdog Timer (WDT) is used to generate a variety of output signals after a user programmable count. The WDT is suitable for use in the prevention of system lock-up, such as when software becomes trapped in a deadlock. Under these sorts of circumstances, the timer will count to zero and the selected outputs will be driven.

Under normal circumstance, you will need to restart the WDT at regular intervals before the timer counts to zero.

Sample Code:

```
//-----
//
// THIS CODE AND INFORMATION IS PROVIDED "AS IS" WITHOUT WARRANTY OF ANY
// KIND, EITHER EXPRESSED OR IMPLIED, INCLUDING BUT NOT LIMITED TO THE
// IMPLIED WARRANTIES OF MERCHANTABILITY AND/OR FITNESS FOR A PARTICULAR
// PURPOSE.
//
//-----
#include <dos.h>
#include <conio.h>
#include <stdio.h>
#include <stdlib.h>
#include "F81866.H"
//-----
int main (int argc, char *argv[]);
void EnableWDT(int);
void DisableWDT(void);
//-----
int main (int argc, char *argv[])
{
    unsigned char bBuf;
    unsigned char bTime;
    char **endptr;

    char SIO;

    printf("Fintek 81866 watch dog program\n");
    SIO = Init_F81866();
    if (SIO == 0)
    {
        printf("Can not detect Fintek 81866, program abort.\n");
        return(1);
    }
    //if (SIO == 0)

    if (argc != 2)
    {
        printf("Parameter incorrect!!\n");
        return (1);
    }
}
```

```

bTime = strtol (argv[1], endptr, 10);
printf("System will reset after %d seconds\n", bTime);

if (bTime)
{
    EnableWDT(bTime); }
else
{
    DisableWDT();      }
return 0;
}
//-----
void EnableWDT(int interval)
{
    unsigned char bBuf;

    bBuf = Get_F81866_Reg(0x2B);
    bBuf &= (~0x20);
    Set_F81866_Reg(0x2B, bBuf);          //Enable WDTO

    Set_F81866_LD(0x07);                //switch to logic device 7
    Set_F81866_Reg(0x30, 0x01);        //enable timer

    bBuf = Get_F81866_Reg(0xF5);
    bBuf &= (~0x0F);
    bBuf |= 0x52;
    Set_F81866_Reg(0xF5, bBuf);        //count mode is second

    Set_F81866_Reg(0xF6, interval);    //set timer

    bBuf = Get_F81866_Reg(0xFA);
    bBuf |= 0x01;
    Set_F81866_Reg(0xFA, bBuf);        //enable WDTO output

    bBuf = Get_F81866_Reg(0xF5);
    bBuf |= 0x20;
    Set_F81866_Reg(0xF5, bBuf);        //start counting
}
//-----
void DisableWDT(void)
{
    unsigned char bBuf;

    Set_F81866_LD(0x07);                //switch to logic device 7

    bBuf = Get_F81866_Reg(0xFA);
    bBuf &= ~0x01;
    Set_F81866_Reg(0xFA, bBuf);        //disable WDTO output

    bBuf = Get_F81866_Reg(0xF5);
    bBuf &= ~0x20;
    bBuf |= 0x40;
    Set_F81866_Reg(0xF5, bBuf);        //disable WDT
}
//-----

//-----

```



```

//
// THIS CODE AND INFORMATION IS PROVIDED "AS IS" WITHOUT WARRANTY OF ANY
// KIND, EITHER EXPRESSED OR IMPLIED, INCLUDING BUT NOT LIMITED TO THE
// IMPLIED WARRANTIES OF MERCHANTABILITY AND/OR FITNESS FOR A PARTICULAR
// PURPOSE.
//
//-----
#include "F81866.H"
#include <dos.h>
//-----
unsigned int F81866_BASE;
void Unlock_F81866 (void);
void Lock_F81866 (void);
//-----
unsigned int Init_F81866(void)
{
    unsigned int result;
    unsigned char ucDid;

    F81866_BASE = 0x4E;
    result = F81866_BASE;

    ucDid = Get_F81866_Reg(0x20);
    if (ucDid == 0x07) //Fintek 81866
    {
        goto Init_Finish;
    }

    F81866_BASE = 0x2E;
    result = F81866_BASE;

    ucDid = Get_F81866_Reg(0x20);
    if (ucDid == 0x07) //Fintek 81866
    {
        goto Init_Finish;
    }

    F81866_BASE = 0x00;
    result = F81866_BASE;

Init_Finish:
    return (result);
}
//-----
void Unlock_F81866 (void)
{
    outputb(F81866_INDEX_PORT, F81866_UNLOCK);
    outputb(F81866_INDEX_PORT, F81866_UNLOCK);
}
//-----
void Lock_F81866 (void)
{
    outputb(F81866_INDEX_PORT, F81866_LOCK);
}
//-----
void Set_F81866_LD( unsigned char LD)
{
    Unlock_F81866();
    outputb(F81866_INDEX_PORT, F81866_REG_LD);
    outputb(F81866_DATA_PORT, LD);
    Lock_F81866();
}

```

```
}
//-----
void Set_F81866_Reg( unsigned char REG, unsigned char DATA)
{
    Unlock_F81866();
    outputb(F81866_INDEX_PORT, REG);
    outputb(F81866_DATA_PORT, DATA);
    Lock_F81866();
}
//-----

unsigned char Get_F81866_Reg(unsigned char REG)
{
    unsigned char Result;
    Unlock_F81866();
    outputb(F81866_INDEX_PORT, REG);
    Result = inputb(F81866_DATA_PORT);
    Lock_F81866();
    return Result;
}
//-----

//-----
//
// THIS CODE AND INFORMATION IS PROVIDED "AS IS" WITHOUT WARRANTY OF ANY
// KIND, EITHER EXPRESSED OR IMPLIED, INCLUDING BUT NOT LIMITED TO THE
// IMPLIED WARRANTIES OF MERCHANTABILITY AND/OR FITNESS FOR A PARTICULAR
// PURPOSE.
//
//-----
#ifndef F81866_H
#define F81866_H                1
//-----
#define F81866_INDEX_PORT      (F81866_BASE)
#define F81866_DATA_PORT      (F81866_BASE+1)
//-----
#define F81866_REG_LD          0x07
//-----
#define F81866_UNLOCK          0x87
#define F81866_LOCK            0xAA
//-----
unsigned int Init_F81866(void);
void Set_F81866_LD( unsigned char);
void Set_F81866_Reg( unsigned char,
unsigned char); unsigned char
Get_F81866_Reg( unsigned char);
//-----
#endif // F81866_H
```

D. On-Board Connector Types

Function	Connector Name	Onboard Type	Mating Type
COM1 & COM2 RS-232/422/485 Ports	CN1	YIMTEX 40909AANSABR	D-SUB 9P (female)
COM3 & COM4 RS-232 Ports	J5 (COM3), J6 (COM4)	HRS DF11-10DP-2DSA	HRS DF11-10DS-2C
eDP Connector	CN6	KEL SSL00-40S	KEL SSL20-40S
Digital I/O Connector	J2	E-call 0196-01-200-100	Dupont 10P 2mm-pitch (female)
ATX Power Connector	J7	HAOGUO 01-0018-03	Molex 39-01-2240
ATX 12V Power Connector	ATX_12V_2X1	HAOGUO 01-0018-02	Molex 39-01-2080
Dual USB 2.0 Connector	J14	HRS DF11-10DP-2DSA	HRS DF11-8DS-2C
Front Panel Audio Connector	J16	E-call 0126-01-2821009	Dupont 10P 2.54 mm-pitch (female)
Front Panel Settings Connector	J18	E-call 0126-01-203-080	Dupont 8P 2.54 mm-pitch (female)
LVDS Connector	J11, J12	HRS DF20F-20DP-1V	HRS DF20A-20DS-1C
Fan Power Connector	CPU_FAN1, SYS_FAN1	TECHBEST W2-03I104132S1WT(A)-L	Molex 47054-1000