

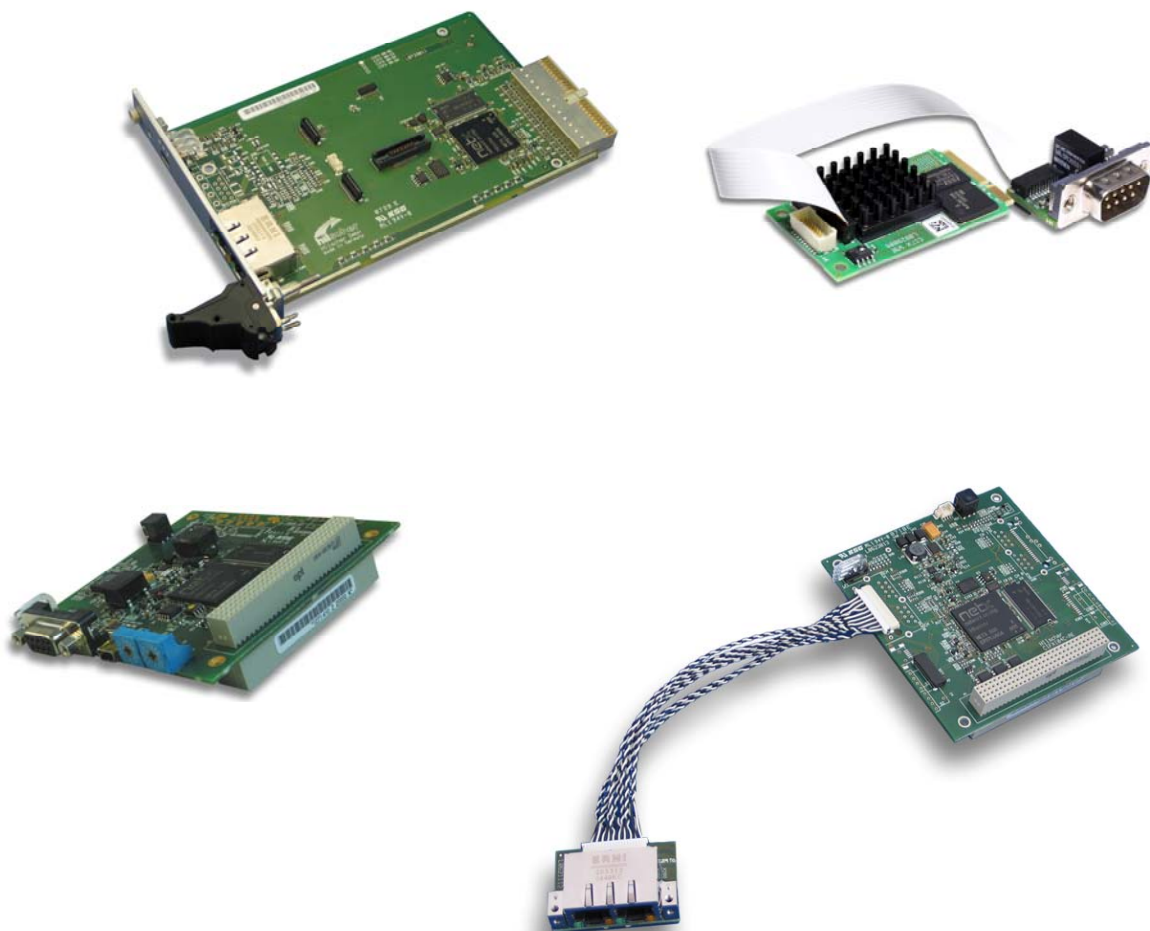

**User Manual**

**PC Cards cifX**  
**Compact PCI (CIFX 80)**  
**Mini PCI (CIFX 90)**  
**Mini PCI Express (CIFX 90E)**  
**PCI-104 (CIFX 104C)**

**Installation, Operation and Hardware Description**



**Hilscher Gesellschaft für Systemautomation mbH**

**[www.hilscher.com](http://www.hilscher.com)**

DOC120205UM46EN | Revision 46 | English | 2015-12 | Released | Public

# Table of Contents

1	INTRODUCTION.....	9
1.1	About the User Manual.....	9
1.1.1	List of Revisions.....	10
1.1.2	Notes on Hardware, Firmware, Software and Driver Versions.....	10
1.1.3	Conventions in this Manual.....	14
1.1.4	Used Terminology.....	14
1.2	Contents of the Product DVD.....	15
1.2.1	Installation Guide, Documentation Overview.....	15
1.2.2	What's New.....	15
1.2.3	Important Changes.....	15
1.2.4	Device Description Files cifX.....	18
1.3	Legal Notes.....	20
1.3.1	Copyright.....	20
1.3.2	Important Notes.....	20
1.3.3	Exclusion of Liability.....	21
1.3.4	Warranty.....	21
1.3.5	Export Regulations.....	22
1.3.6	Registered Trademarks.....	22
1.3.7	EtherCAT Disclaimer.....	23
1.3.8	Obligation to read and understand the Manual.....	23
1.4	Licenses.....	23
1.4.1	License Note about VARAN Client.....	23
2	SAFETY.....	24
2.1	General Note.....	24
2.2	Intended Use.....	24
2.3	Personnel Qualification.....	26
2.4	Safety Instructions to avoid Personal Injury.....	26
2.4.1	Electrical Shock Hazard.....	26
2.5	Safety Instructions to avoid Property Damage.....	27
2.5.1	Device Destruction by exceeding allowed Supply Voltage.....	27
2.5.2	Device Destruction by exceeding allowed Signaling Voltage.....	28
2.5.3	Electrostatically sensitive Devices.....	28
2.6	Labeling of Safety Messages.....	29
2.6.1	References Safety.....	29
3	DESCRIPTIONS AND REQUIREMENTS.....	30
3.1	Description.....	30
3.2	PC Cards cifX with integrated Interfaces.....	31
3.2.1	PC Cards Compact PCI CIFX 80-XX.....	31
3.2.2	PC Cards PCI-104: CIFX 104C-XX and CIFX 104C-XX-R.....	31
3.3	PC Cards cifX with AIFX Assembly Interfaces.....	32

3.3.1	The Label „\F“ in the Device Name .....	32
3.3.2	PC Cards Mini PCI CIFX 90-XX\F .....	33
3.3.3	PC Cards Mini PCI Express CIFX 90E-XX\F .....	33
3.3.4	PC Cards cifX Mini PCI Express CIFX 90E-XX\ET\F .....	34
3.3.5	PC Cards cifX Mini PCI Express (2 Channels) CIFX 90E-2XX\ET\F, CIFX 90E-2XX\XX\ET\F .....	35
3.3.6	PC Cards Mini PCI Express CIFX 90E-XX\MR\F .....	36
3.3.7	PC Cards Mini PCI Express CIFX 90E-XX\MR\ET\F .....	37
3.3.8	PC Cards cifX Mini PCI Express (2 Channels) CIFX 90E-2XX\MR\ET\F, CIFX 90E-2XX\XX\MR\ET\F .....	38
3.3.9	PC Cards PCI-104: CIFX 104C-XX\F and CIFX 104C-XX-R\F .....	39
3.3.10	AIFX Assembly Interfaces .....	40
3.4	The Function „DMA Mode“ .....	41
3.5	PC Cards cifX with additional MRAM .....	42
3.6	System Requirements .....	43
3.6.1	Slot for the PC Cards cifX Compact PCI, Mini PCI, Mini PCIe, PCI-104 .....	43
3.6.2	Notes on the Card Height - PC Card cifX Mini PCI and Mini PCIe .....	44
3.6.3	Panel Cutout for Installing AIFX .....	45
3.6.4	Operating Temperature Range for UL Certificate .....	46
3.6.5	Power Supply and Host Interface .....	46
3.7	Requirements for Operation of the PC Cards cifX .....	48
3.8	Prerequisites for Certification .....	49
3.8.1	PROFINET IO Certification for IRT and SYNC0 Signal .....	49
4	GETTING STARTED .....	50
4.1	Installation and Configuration PC Card cifX .....	50
4.2	Note on Exchange Service (Replacement Case) .....	54
4.3	Notes for the Configuration of the Master Device .....	54
4.4	Device Names in SYCON.net .....	55
4.5	Update for Firmware, Driver and Software .....	57
5	DEVICE DRAWINGS .....	58
5.1	PC Cards cifX Compact PCI .....	58
5.1.1	CIFX 80-RE .....	58
5.1.2	CIFX 80-DP .....	59
5.1.3	CIFX 80-CO .....	60
5.1.4	CIFX 80-DN .....	61
5.2	PC Cards cifX Mini PCI and Mini PCI Express .....	62
5.2.1	CIFX 90-RE\F, CIFX 90E-RE\F and MR and/or ET Variants .....	62
5.2.2	CIFX 90-FB\F, CIFX 90E-FB\F and MR and/or ET Variants .....	63
5.2.3	CIFX 90E-2FB\ET\F and CIFX 90E-2FB\MR\ET\F .....	64
5.2.4	Reverse Side CIFX 90-XX\F, CIFX 90E-XX\F and Variants .....	64
5.3	PC Cards cifX PCI-104 .....	65
5.3.1	CIFX 104C-RE, CIFX 104C-RE-R .....	65
5.3.2	CIFX 104C-RE\F, CIFX 104C-RE-R\F .....	66
5.3.3	CIFX 104C-DP, CIFX 104C-DP-R .....	67

5.3.4	CIFX 104C-CO, CIFX 104C-CO-R.....	68
5.3.5	CIFX 104C-DN, CIFX 104C-DN-R .....	69
5.3.6	CIFX 104C-DP\F, CIFX 104C-CO\F, CIFX 104C-DN\F, CIFX 104C-CC\F .....	70
5.3.7	CIFX 104C-DP-R\F, CIFX 104C-CO-R\F, CIFX 104C-DN-R\F .....	70
5.3.8	Reverse Side CIFX 104C-XX (all Basic Cards and Variants) .....	71
5.4	AIFX Assembly Interfaces .....	72
5.4.1	Ethernet - AIFX-RE.....	72
5.4.2	PROFIBUS - AIFX-DP.....	73
5.4.3	CANopen - AIFX-CO .....	74
5.4.4	DeviceNet - AIFX-DN .....	75
5.4.5	CC-Link - AIFX-CC.....	76
5.4.6	Diagnostic - AIFX-DIAG .....	77
6	HARDWARE INSTALLATION AND UNINSTALLING .....	78
6.1	Safety Messages on Personal Injury .....	79
6.1.1	Electrical Shock Hazard .....	79
6.2	Property Damage Messages .....	80
6.2.1	Device Destruction by exceeding allowed Supply Voltage .....	80
6.2.2	Device Destruction by exceeding allowed Signaling Voltage .....	80
6.2.3	Electrostatically sensitive Devices.....	80
6.3	Fix Front Plate Sticker at CIFX 80-RE .....	81
6.4	Installing PC Cards cifX Compact PCI.....	82
6.5	Uninstalling PC Cards cifX Compact PCI .....	83
6.6	Installing PC Cards cifX Mini PCI and Mini PCI Express .....	84
6.7	Uninstalling PC Cards cifX Mini PCI, Mini PCI Express .....	87
6.8	Installing PC Cards cifX PCI-104 (PCI-104-Modules) .....	89
6.9	Uninstalling PC Cards cifX PCI-104 .....	92
7	TROUBLESHOOTING .....	93
7.1	Instructions for Problem Solving .....	93
8	LED DESCRIPTIONS .....	94
8.1	Overview LEDs Real-Time Ethernet Systems .....	94
8.2	Overview LEDs Fieldbus Systems.....	95
8.3	System LED.....	96
8.4	Power On LED.....	96
8.5	EtherCAT Master .....	97
8.6	EtherCAT Slave .....	98
8.7	EtherNet/IP Scanner (Master) .....	99
8.8	EtherNet/IP Adapter (Slave) .....	100
8.9	Open Modbus/TCP .....	101
8.10	POWERLINK Controlled Node/Slave .....	102
8.11	PROFINET IO-Controller .....	103

8.12	PROFINET IO-Device.....	104
8.13	sercos Master .....	105
8.14	sercos Slave .....	107
8.15	VARAN Client (Slave).....	109
8.16	PROFIBUS DP Master .....	110
8.16.1	1 Communication Status LED .....	110
8.16.2	2 Communication Status LEDs .....	111
8.17	PROFIBUS DP Slave .....	112
8.17.1	1 Communication Status LED .....	112
8.17.2	2 Communication Status LEDs .....	113
8.18	PROFIBUS MPI Device .....	114
8.18.1	1 Communication Status LED .....	114
8.18.2	2 Communication Status LEDs .....	115
8.19	CANopen Master .....	116
8.19.1	1 Communication Status LED .....	116
8.19.2	2 Communication Status LEDs .....	117
8.20	CANopen Slave .....	118
8.20.1	1 Communication Status LED .....	118
8.20.2	2 Communication Status LEDs .....	119
8.21	DeviceNet Master .....	120
8.22	DeviceNet Slave .....	121
8.23	CC-Link Slave.....	122
8.24	Slave.....	122
<b>9</b>	<b>DEVICE CONNECTIONS AND SWITCHES .....</b>	<b>123</b>
9.1	Ethernet Interface .....	123
9.1.1	Ethernet Pin Assignment at the RJ45 Socket .....	123
9.1.2	Ethernet Connection Data .....	124
9.1.3	Use of Hubs and Switches .....	124
9.2	PROFIBUS Interface .....	125
9.3	CANopen Interface .....	125
9.4	DeviceNet Interface .....	126
9.5	CC-Link Interface.....	126
9.6	Mini-B USB Connector (5 Pin).....	127
9.7	Rotary Switch for PCI-104 Slot Number .....	127
9.8	Rotary Switch Device Address .....	127
9.9	Cable Connector.....	128
9.9.1	Pin Assignment for Cable Connector Ethernet .....	128
9.9.2	Pin Assignment for Cable Connector Fieldbus X3, X304, X4 .....	129
9.9.3	Pin Assignment for Cable Connector Fieldbus X3 and X4 for 2 Channel Devices .....	129
9.9.4	Pin Assignment for Cable Connector DIAG .....	130
9.10	SYNC Connector (Pin-Assignment, Hardware/Firmware) .....	131

9.10.1	Pin Assignment SYNC Connector, X51 (CIFX 80 90 104C).....	131
9.10.2	Items on Hardware .....	131
9.10.3	Items on Firmware.....	131
9.11	Pin Assignment at the PCI Bus.....	132
9.11.1	Overview.....	132
9.11.2	References PCI Specifications.....	133
9.11.3	Pin Assignment for Mini PCI Bus, X1 .....	133
9.11.4	Pin Assignment for Mini PCI Express Bus / SYNC Connector (Bootstart), X1/X2 .....	135
9.11.5	Pin Assignment for Mini PCI Express Bus, X1/X2 for 2 Channel Devices.....	137
10	TECHNICAL DATA .....	139
10.1	Technical Data PC Cards cifX .....	139
10.1.1	CIFX 80-RE .....	139
10.1.2	CIFX 80-DP .....	141
10.1.3	CIFX 80-CO.....	142
10.1.4	CIFX 80-DN .....	144
10.1.5	CIFX 90-RE\F .....	145
10.1.6	CIFX 90-DP\F .....	147
10.1.7	CIFX 90-CO\F.....	148
10.1.8	CIFX 90-DN\F.....	150
10.1.9	CIFX 90-CC\F.....	151
10.1.10	CIFX 90E-RE\F, CIFX 90E-RE\ET\F, CIFX 90E-RE\MR\F, CIFX 90E-RE\MR\ET\F .....	153
10.1.11	CIFX 90E-DP\F, CIFX 90E-DP\ET\F, CIFX 90E-DP\MR\F, CIFX 90E-DP\MR\ET\F .....	155
10.1.12	CIFX 90E-CO\F, CIFX 90E-CO\ET\F, CIFX 90E-CO\MR\F, CIFX 90E-CO\MR\ET\F .....	157
10.1.13	CIFX 90E-DN\F, CIFX 90E-DN\ET\F, CIFX 90E-DN\MR\F, CIFX 90E-DN\MR\ET\F .....	159
10.1.14	CIFX 90E-CC\ET\F, CIFX 90E-CC\MR\ET\F .....	162
10.1.15	CIFX 90E-2DP\ET\F, CIFX 90E-2DP\MR\ET\F .....	163
10.1.16	CIFX 90E-2DP\CO\ET\F, CIFX 90E-2DP\CO\MR\ET\F.....	165
10.1.17	CIFX 90E-2DP\DN\ET\F, CIFX 90E-2DP\DN\MR\ET\F .....	167
10.1.18	CIFX 90E-2CO\ET\F, CIFX 90E-2CO\MR\ET\F.....	169
10.1.19	CIFX 90E-2CO\DN\ET\F, CIFX 90E-2CO\DN\MR\ET\F .....	171
10.1.20	CIFX 90E-2DN\ET\F, CIFX 90E-2DN\MR\ET\F .....	173
10.1.21	CIFX 104C-RE, CIFX 104C-RE-R.....	175
10.1.22	CIFX 104C-RE\F, CIFX 104C-RE-R\F .....	177
10.1.23	CIFX 104C-DP, CIFX 104C-DP-R.....	179
10.1.24	CIFX 104C-DP\F, CIFX 104C-DP-R\F .....	180
10.1.25	CIFX 104C-CO, CIFX 104C-CO-R.....	182
10.1.26	CIFX 104C-CO\F, CIFX 104C-CO-R\F .....	184
10.1.27	CIFX 104C-DN, CIFX 104C-DN-R .....	185
10.1.28	CIFX 104C-DN\F, CIFX 104C-DN-R\F.....	187
10.1.29	CIFX 104C-CC\F .....	189
10.1.30	AIFX-RE .....	191
10.1.31	AIFX-DP .....	192
10.1.32	AIFX-CO .....	193
10.1.33	AIFX-DN .....	194

10.1.34	AIFX-CC .....	195
10.1.35	AIFX-DIAG.....	196
10.2	PCI IDs PC Cards cifX on the PCI Bus.....	197
10.3	Supported PCI Bus Commands.....	197
10.4	Technical Data of the Communication Protocols.....	198
10.4.1	EtherCAT Master.....	198
10.4.2	EtherCAT Slave.....	199
10.4.3	EtherNet/IP Scanner (Master).....	200
10.4.4	EtherNet/IP Adapter (Slave).....	201
10.4.5	Open Modbus/TCP.....	202
10.4.6	POWERLINK Controlled Node/Slave.....	202
10.4.7	PROFINET IO-Controller.....	203
10.4.8	PROFINET IO-Device (V3.4) .....	204
10.4.9	PROFINET IO-Device (V3.5) .....	205
10.4.10	sercos Master .....	206
10.4.11	sercos Slave .....	207
10.4.12	VARAN Client (Slave).....	208
10.4.13	PROFIBUS DP Master .....	209
10.4.14	PROFIBUS DP Slave .....	210
10.4.15	PROFIBUS MPI.....	211
10.4.16	CANopen Master .....	212
10.4.17	CANopen Slave.....	213
10.4.18	DeviceNet Master.....	214
10.4.19	DeviceNet Slave.....	215
10.4.20	CC Link Slave.....	216
11	ANNEX.....	217
11.1	Device Label with Matrix or Bar Code .....	217
11.2	Tolerances of the shown Card Dimensions .....	218
11.3	Dimensioning PC Cards cifX Compact PCI .....	219
11.3.1	CIFX 80-RE .....	219
11.3.2	Front Panel CIFX 80-RE .....	219
11.3.3	CIFX 80-DP .....	220
11.3.4	Front Panel CIFX 80-DP .....	220
11.3.5	CIFX 80-CO.....	221
11.3.6	Front Panel CIFX 80-CO .....	221
11.3.7	CIFX 80-DN.....	222
11.3.8	Front Panel CIFX 80-DN .....	222
11.4	Dimensioning PC Cards cifX Mini PCI and Mini PCI Express .....	223
11.4.1	CIFX 90-XX\F and Variants.....	223
11.4.2	CIFX 90E-XX\F and Variants .....	223
11.5	Dimensioning PC Cards cifX PCI-104 .....	224
11.5.1	CIFX 104C-RE.....	224
11.5.2	CIFX 104C-RE\F .....	225
11.5.3	CIFX 104C-DP.....	226
11.5.4	CIFX 104C-CO .....	227
11.5.5	CIFX 104C-DN .....	228

11.5.6	CIFX 104C-FB\F.....	229
11.5.7	Reverse Side CIFX 104C-XX (all Basic Cards and Variants) .....	230
11.6	Dimensioning AIFX Assembly Interfaces.....	231
11.6.1	Ethernet - AIFX-RE.....	231
11.6.2	PROFIBUS - AIFX-DP.....	231
11.6.3	CANopen - AIFX-CO .....	232
11.6.4	DeviceNet - AIFX-DN .....	232
11.6.5	CC-Link - AIFX-CC.....	233
11.6.6	Diagnose - AIFX-DIAG .....	233
11.7	Notes on earlier Hardware Revisions .....	234
11.7.1	Failure in 10 MBit/s Half Duplex Mode and Workaround .....	234
11.7.2	Pin Assignment for Mini PCI Express Bus / SYNC Connector (Bootstart), X1/X2 .....	235
11.8	Disposal of Waste Electronic Equipment .....	237
11.9	References .....	237
11.10	EtherCAT Summary over Vendor ID, Conformance test, Membership and Network Logo.....	238
11.10.1	Vendor ID .....	238
11.10.2	Conformance .....	238
11.10.3	Certified Product vs. Certified Network Interface .....	238
11.10.4	Membership and Network Logo .....	238
11.11	List of Figures .....	239
11.12	List of Tables .....	240
11.13	Glossary.....	244
11.14	Contacts.....	254



# 1 Introduction

## 1.1 About the User Manual

This user manual provides descriptions of the **installation, operation and hardware** of the PC cards *cifX Compact PCI, Mini PCI, Mini PCI Express* and *PCI-104* under Windows® XP, Windows® Vista, Windows® 7 and Windows® 8, as listed subsequently.

PC Cards cifX:

- Compact PCI (CIFX 80),
- Mini PCI (CIFX 90)<sup>A</sup>,
- Mini PCI Express (CIFX 90E)<sup>A</sup>,
- PCI-104 (CIFX 104C)<sup>A+B</sup>

for CIFX 90, - 90E and - 104C inclusively the AIFX Assembly Interfaces<sup>1</sup>:

- |  |   |
|--|---|
| <ul style="list-style-type: none"> <li>▪ Ethernet (AIFX-RE)<sup>A</sup></li> </ul> | <ul style="list-style-type: none"> <li>▪ PROFIBUS (AIFX-DP)<sup>A</sup></li> <li>▪ CANopen (AIFX-CO)<sup>A</sup></li> <li>▪ DeviceNet (AIFX-DN)<sup>A</sup></li> <li>▪ CC-Link (AIFX-CC)<sup>A</sup></li> <li>▪ Diagnose (AIFX-DIAG)<sup>B</sup></li> </ul> |
|--|---|

for the Real-Time Ethernet systems:

- EtherCAT
- EtherNet/IP
- Open Modbus/TCP
- POWERLINK
- PROFINET IO
- sercos
- VARAN

for the fieldbus systems:

- PROFIBUS DP
- PROFIBUS MPI
- CANopen
- DeviceNet
- CC-Link



For information about the **Installation of the Software** refer to the User Manual „Software Installation for PC cards cifX“ [DOC120207UMXXEN].

For information about the **Wiring of the Protocol Interface** refer to the „Wiring Instructions“ [DOC120208UMXXEN].

The **devices described in this manual** are listed in the sections *PC Cards cifX with integrated Interfaces* (page 31) and *PC Cards cifX with AIFX Assembly Interfaces* (page 32). The devices are described in detail in the chapters *Hardware Installation and Uninstalling* (page 78), *LED Descriptions* (page 94), *Device Connections and Switches* (page 123) and *Technical Data* (page 139).

You can download the latest edition of a manual from the website [www.hilscher.com](http://www.hilscher.com) under **Support > Downloads > Manuals** or under **Products** directly with the information about your product.

<sup>1</sup> The AIFX Assembly Interface is also named as „Detached Network Interface“.

## 1.1.1 List of Revisions

Index	Date	Chapter	Revisions
42	14-12-01	All  3.6.4, 7.1, 8.1, 8.2, 8.14, 10.1, 11.13	Details about the PC cards CIFX 90E-CC/ET/F, CIFX 90E-CC/MR/ET/F, CIFX 90-CC/F and CIFX 104C-CC/F as well as for the assembly interface AIFX-CC added.  CIFX 90E-2DP\ET\F CIFX 90E-2DP\CO\ET\F CIFX 90E-2DP\DN\ET\F CIFX 90E-2CO\ET\F CIFX 90E-2CO\DN\ET\F CIFX 90E-2DN\ET\F  CIFX 90E-2DP\MR\ET\F CIFX 90E-2DP\CO\MR\ET\F CIFX 90E-2DP\DN\MR\ET\F CIFX 90E-2CO\MR\ET\F CIFX 90E-2CO\DN\MR\ET\F CIFX 90E-2DN\MR\ET\F  Section <i>Operating Temperature Range for UL Certificate</i> added, Section <i>Instructions for Problem Solving, Overview LEDs Real-Time Ethernet Systems, Overview LEDs Fieldbus Systems, sercos Slave, Technical Data PC Cards cifX, Glossary</i> updated or completed.
43	15-02-10	5 11.1, 11.2, 11.3, 11.4, 11.5 11.6	<b>Note:</b> 'Preliminary' status refers only to the sections 11.1 to 11.6. All other parts of this revision are in 'released' status. Chapter <i>Device Drawings</i> revised and completed. Section <i>Device Label with Matrix or Bar Code</i> updated. Section <i>Tolerances of the shown Card Dimensions, Dimensioning PC Cards cifX Compact PCI, Dimensioning PC Cards cifX Mini PCI and Mini PCI Express and Dimensioning PC Cards cifX PCI-104</i> added. Section <i>Dimensioning AIFX Assembly Interfaces</i> moved to the annex (until rev. 42 in chapter 'Device Drawings').
44	15-06-17	1.1.2.2, 8, 10.1.1 - 10.1.4, 11.3, 11.4, 11.5	Section <i>Firmware</i> updated. Chapter <i>LED Descriptions</i> revised. Section <i>CIFX 80-RE to CIFX 80-DN</i> length corrected for PC cards cifX Compact PCI to L = 162,5 mm. Section <i>Dimensioning PC Cards cifX Compact PCI, Dimensioning PC Cards cifX Mini PCI and Mini PCI Express and Dimensioning PC Cards cifX PCI-104</i> slight corrections added.
45	15-07-30	1.1.2.1, 5.4.5, 11.6.5,  11.13	Sections <i>Hardware: PC Cards cifX, AIFX Assembly Interfaces, CC-Link - AIFX-CC</i> (device drawing), <i>CC-Link - AIFX-CC</i> (dimensioning): update to hardware rev. 02. Section <i>Glossary</i> : entry "Firmware" revised.
46	15-12-04	3.8, 9.11.4	Section <i>Prerequisites for Certification</i> added. Section <i>Pin Assignment for Mini PCI Express Bus / SYNC Connector (Bootstart), X1/X2</i> , note added about names of the pins 33,31, 25 and 21.

Table 1: List of Revisions

## 1.1.2 Notes on Hardware, Firmware, Software and Driver Versions



**Note on Software Update:** The hardware revisions and the versions for the firmware, the driver or the configuration software listed in this section functionally belong together. For existing hardware installation the firmware, the driver and the configuration software must be updated according to the details listed in this section.

For the software upgrade system overview refer to section *Update for Firmware, Driver and Software* on page 57.

### 1.1.2.1 Hardware: PC Cards cifX, AIFX Assembly Interfaces

PC Card cifX , AIFX	Part No.	Hardware Revision	USB from HW Rev.	„DMA Mode“ from HW Rev.
CIFX 80-RE	1280.100	3	1	1
CIFX 90-REVF <sup>1</sup>	1290.100	4	-	1
CIFX 90E-REVF <sup>1</sup>	1291.100	B	-	A
CIFX 90E-REVMRF <sup>1</sup>	1291.102	B	-	B

PC Card cifX , AIFX	Part No.	Hardware Revision	USB from HW Rev.	„DMA Mode“ from HW Rev.	
CIFX 90E-RE\VF <sup>1</sup>	1291.104	1	-	1	
CIFX 90E-RE\MR\VF <sup>1</sup>	1291.106	1	-	1	
CIFX 104C-RE	1270.100	5	1	1	
CIFX 104C-RE-R	1271.100	5	1	1	
CIFX 104C-RE\VF <sup>1</sup>	1270.101	5	5 <sup>6</sup>	1	
CIFX 104C-RE-R\VF <sup>1</sup>	1271.101	5	5 <sup>6</sup>	1	
CIFX 80-DP	1280.410	3	1	1	
CIFX 80-CO	1280.500	3	1	1	
CIFX 80-DN	1280.510	3	1	1	
CIFX 90-DP\VF <sup>2</sup>	1290.410	4	-	1	
CIFX 90-CO\VF <sup>3</sup>	1290.500	4	-	1	
CIFX 90-DN\VF <sup>4</sup>	1290.510	4	-	1	
CIFX 90-CC\VF <sup>5</sup>	1290.740	4	-	1	
CIFX 90E-DP\VF <sup>2</sup>	1291.410	B	-	A	
CIFX 90E-DP\MR\VF <sup>2</sup>	1291.412	B	-	B	
CIFX 90E-DP\VF <sup>2</sup>	1291.414	1	-	1	
CIFX 90E-DP\MR\VF <sup>2</sup>	1291.416	1	-	1	
CIFX 90E-CO\VF <sup>3</sup>	1291.500	B	-	A	<sup>1</sup> inclusively Ethernet Assembly Interface (AIFX-RE)
CIFX 90E-CO\MR\VF <sup>3</sup>	1291.502	B	-	B	<sup>2</sup> inclusively PROFIBUS Assembly Interface (AIFX-DP)
CIFX 90E-CO\VF <sup>3</sup>	1291.504	1	-	1	
CIFX 90E-CO\MR\VF <sup>3</sup>	1291.506	1	-	1	
CIFX 90E-DN\VF <sup>4</sup>	1291.510	B	-	A	<sup>3</sup> inclusively CANopen Assembly Interface (AIFX-CO)
CIFX 90E-DN\MR\VF <sup>4</sup>	1291.512	B	-	B	
CIFX 90E-DN\VF <sup>4</sup>	1291.514	1	-	1	
CIFX 90E-DN\MR\VF <sup>4</sup>	1291.516	1	-	1	
CIFX 90E-CC\VF <sup>5</sup>	1291.744	1	-	1	<sup>4</sup> inclusively DeviceNet Assembly Interface (AIFX-DN)
CIFX 90E-CC\MR\VF <sup>5</sup>	1291.746	1	-	1	<sup>5</sup> inclusively CC-Link Assembly Interface (AIFX-CC)
CIFX 90E-2DP\VF <sup>2</sup>	1293.414	2	1	1	
CIFX 90E-2DP\MR\VF <sup>2</sup>	1293.416	2	1	1	
CIFX 90E-2DP\CO\VF <sup>2,3</sup>	1293.474	2	1	1	
CIFX 90E-2DP\CO\MR\VF <sup>2,3</sup>	1293.476	2	1	1	
CIFX 90E-2DP\DN\VF <sup>2,4</sup>	1293.484	2	1	1	<sup>6</sup> only when using the Diagnostic Assembly Interface (AIFX-DIAG)
CIFX 90E-2DP\DN\MR\VF <sup>2,4</sup>	1293.486	2	1	1	
CIFX 90E-2CO\VF <sup>3</sup>	1293.504	2	1	1	
CIFX 90E-2CO\MR\VF <sup>3</sup>	1293.506	2	1	1	
CIFX 90E-2DN\VF <sup>4</sup>	1293.514	2	1	1	
CIFX 90E-2DN\MR\VF <sup>4</sup>	1293.516	2	1	1	
CIFX 90E-2CO\DN\VF <sup>3,4</sup>	1293.574	2	1	1	
CIFX 90E-2CO\DN\MR\VF <sup>3,4</sup>	1293.576	2	1	1	
CIFX 104C-DP	1270.410	2	1	1	
CIFX 104C-DP-R	1271.410	2	1	1	
CIFX 104C-DP\VF <sup>2</sup>	1270.411	2	1 <sup>6</sup>	1	
CIFX 104C-DP-R\VF <sup>2</sup>	1271.411	2	1 <sup>6</sup>	1	
CIFX 104C-CO	1270.500	2	1	1	
CIFX 104C-CO-R	1271.500	2	1	1	
CIFX 104C-CO\VF <sup>3</sup>	1270.501	2	1 <sup>6</sup>	1	
CIFX 104C-CO-R\VF <sup>3</sup>	1271.501	2	1 <sup>6</sup>	1	
CIFX 104C-DN	1270.510	2	1	1	
CIFX 104C-DN-R	1271.510	2	1	1	

PC Card cifX , AIFX	Part No.	Hardware Revision	USB from HW Rev.	„DMA Mode“ from HW Rev.
CIFX 104C-DNF <sup>4</sup>	1270.511	2	1 <sup>6</sup>	1
CIFX 104C-DN-RIF <sup>4</sup>	1271.511	2	1 <sup>6</sup>	1
CIFX 104C-CCF <sup>5</sup>	1270.741	2	1 <sup>6</sup>	1
AIFX-RE	2800.100	2	-	-
AIFX-DP	2800.400	2	-	-
AIFX-CO	2800.500	2	-	-
AIFX-DN	2800.510	3	-	-
AIFX-CC	2800.730	2	-	-
AIFX-DIAG	2800.000	2	-	-

Table 2: Reference on Hardware PC Cards cifX, AIFX Assembly Interfaces

### 1.1.2.2 Firmware

Fieldbus System	Firmware File*	Firmware Version	Minimum Version of the Firmware for USB Support
CANopen Master	CIFXCOM.NXF	2.11.x.x	from 2.5.2.0
CANopen Slave	CIFXCOS.NXF	3.6.x.x	from 2.4.4.0
CC-Link Slave	CIFXCCS.NXF	2.9.x.x	-
DeviceNet Master	CIFXDNM.NXF	2.3.x.x	from 2.2.7.0
DeviceNet Slave	CIFXDNS.NXF	2.3.x.x	from 2.2.7.0
EtherCAT Master	CIFXECM.NXF	3.0.x.x	from 2.4.4.0
EtherCAT Slave	CIFXECS.NXF	2.5. x.x (V2)	from 2.5.13.0
EtherCAT Slave	CIFXECS.NXF	4.2.x.x (V4)	from 2.5.13.0
EtherNet/IP Adapter	CIFXEIS.NXF	2.7. x.x	from 2.3.4.1
EtherNet/IP Scanner	CIFXEIM.NXF	2.6. x.x	from 2.2.4.1
Open Modbus/TCP	CIFXOMB.NXF	2.5. x.x	from 2.3.2.1
POWERLINK Controlled Node	CIFXPLS.NXF	2.1. x.x	from 2.1.22.0
PROFIBUS DP Master	CIFXDPM.NXF	2.6.x.x	from 2.3.22.0
PROFIBUS DP Slave	CIFXDPS.NXF	2.7.x.x	from 2.3.30.0
PROFIBUS MPI Device	CIFXMPI.NXF	2.4.x.x	from 2.4.1.2
PROFINET IO Controller	CIFXPNM.NXF	2.6. x.x	from 2.4.10.0
PROFINET IO Device	CIFXPNS.NXF	3.4.x.x (V3)	from 3.4.9.0
PROFINET IO Device	CIFXPNS.NXF	3.5.x.x (V3)	from 3.4.9.0
sercos Master	CIFXS3M.NXF	2.1.x.x	from 2.0.14.0
sercos Slave	CIFXS3S.NXF	3.1.x.x	from 3.0.13.0
VARAN Client	CIFXVRS.NXF	1.0.x.x	from 1.0.3.0

Table 3: Reference on Firmware (for 1 Channel Systems)



**Note:** \*Unless otherwise indicated, in this manual data to the firmware version correspond to the stack version.

The downloadable cifX firmware runs on PC Cards cifX *Compact PCI*, *Mini PCI*, *Mini PCI Express* and *PCI-104*. The firmware automatically detects whether it is running on a PC Cards cifX *Compact PCI*, *Mini PCI*, *Mini PCI Express* and *PCI-104*.

## PC Cards Mini PCI Express with two Channels:

Protocol Channel X3	Stack-Version	Protocol Channel X4	Stack-Version	Firmware File	Firmware Version
CANopen Master	2.11.x.x	CANopen Master	2.11.x.x	C0204040.NXF	1.0.x.x
CANopen Master	2.11.x.x	CANopen Slave	3.6.x.x	C0204050.NXF	1.0.x.x
CANopen Master	2.11.x.x	DeviceNet Master	2.3.x.x	C0204060.NXF	1.0.x.x
CANopen Slave	3.6.x.x	CANopen Slave	3.6.x.x	C0205050.NXF	1.0.x.x
CANopen Slave	3.6.x.x	DeviceNet Slave	2.3.x.x	C0205070.NXF	1.0.x.x
DeviceNet Master	2.3.x.x	DeviceNet Master	2.3.x.x	C0206060.NXF	1.0.x.x
DeviceNet Slave	2.3.x.x	DeviceNet Slave	2.3.x.x	C0207070.NXF	1.0.x.x
PROFIBUS DP Master	2.6.x.x	PROFIBUS DP Master	2.6.x.x	CIFX2DPM.NXF	1.0.x.x (new version counting)
PROFIBUS DP Master	2.6.x.x	CANopen Master	2.11.x.x	C0201040.NXF	1.0.x.x
PROFIBUS DP Master	2.6.x.x	DeviceNet Master	2.3.x.x	C0201060.NXF	1.0.x.x
PROFIBUS DP Slave	2.7.x.x	PROFIBUS DP Slave	2.7.x.x	CIFX2DPS.NXF	1.0.x.x (new version counting)
PROFIBUS DP Slave	2.7.x.x	CANopen Slave	3.6.x.x	C0202050.NXF	1.0.x.x
PROFIBUS DP Slave	2.7.x.x	DeviceNet Slave	2.3.x.x	C0202070.NXF	1.0.x.x

Table 4: Reference on Firmware (for 2 Channel Systems)

## 1.1.2.3 Driver and Software

Driver and Software	Version	
<b>SYCON.net</b>	SYCONnet netX setup.exe	1.360.x.x
<b>netX Configuration Tool-Setup</b>	netXConfigurationUtility_Setup.exe	1.0510.x.x
<b>cifX Device Driver</b>	cifX Device Driver Setup.exe	1.2.x.x
<b>Toolkit</b>		1.1.x.x
<b>cifX TCP/IP Server for SYCON.net</b>	cifX TCP Server.exe	V2.1.0.0
<b>US Driver</b>	USB Driver of Windows®	5.1.2600.x

Table 5: Reference on Driver and Software

### 1.1.3 Conventions in this Manual

Notes, operation instructions and results of operation steps are marked as follows:

#### Notes



**Important:** <important note you must follow to avoid malfunction>



**Note:** <general note>



<note, where to find further information>

#### Operation Instructions

1. <instruction>
2. <instruction>

or

- <instruction>

#### Results

↻ <result>

#### Safety Messages

The labeling of safety messages is explained in the chapter *Safety*.

### 1.1.4 Used Terminology

<b>PC Card cifX</b>	Communication Interfaces of the cifX family of Hilscher based on the netX technology.
<b>CIFX 80-RE</b>	Example for the product name for a PC card cifX Real-Time Ethernet.
<b>CIFX 90E-XX</b>	Example ('XX' replaces 'RE', 'DP', 'CO', 'DN' or 'CC')
<b>CIFX 90E-FB</b>	Example ('FB' replaces 'DP', 'CO', 'DN' or 'CC')



For further terminology to the PC cards cifX, its installation, configuration and operation refer to section *Glossary* on page 244.

## 1.2 Contents of the Product DVD

On the **Communication Solutions DVD** you will find these installation instructions about the software installation and the necessary configuration software, the documentation, the drivers and software for your PC card cifX, and additional auxiliary tools.

### 1.2.1 Installation Guide, Documentation Overview



---

The installation guide **Software Installation and Documentation Overview** on the Communication Solutions DVD are in the directory *Documentation\0. Installation and Overview*. The installation guide includes:

- An overview on the **Content of the Communication Solutions DVD** (in the section *What is on the Communication Solutions DVD?*)
  - Overviews listing the available **Documentations** for PC cards cifX (in chapter *PC Cards cifX, Software and Documentation*).
- 

### 1.2.2 What's New



---

All current version information for hardware and software described in this manual are provided in the folder *\Documentation\What's New - Communication Solutions DVD RL XX EN.pdf* on the Communication Solutions DVD.

---

### 1.2.3 Important Changes

#### 1.2.3.1 DeviceNet Master - SYCON.net and Firmware

The DeviceNet Master firmware from V2.3.11.0 and the DeviceNet Master DTM from V1.360.x.x support the network scan function. If in the device a firmware version V2.3.10.0 or earlier is used then a firmware update to V2.3.11.0 or higher must be done, in order to use the **network scan** function.

### 1.2.3.2 PROFINET IO-Device Firmware Versions 3.4 and 3.5

The PROFINET IO Device firmware was revised and completed and is available in version 3.5 since the third quarter 2013.

Use the PROFINET IO Device firmware in version 3.5 for a new installation, when you create or develop your application program for the first time.

If you want to change in an existing system from the PROFINET IO Device firmware version 3.4 to the version 3.5, note the following guidelines:

1. Customize your application program according to the Migration Guide **PROFINET IO Device, Migration from V3.4 to V3.5**.



If you want to change to V3.5, please check in the Migration Guide **PROFINET IO Device, Migration from V3.4 to V3.5** which changes are necessary in the application program in order to use version 3.5.

2. Adjust the configuration of your PROFINET IO Controller device. Use the new GSDML file in the configuration software of the PROFINET IO Controller for this:  
*GSDML-V2.3-HILSCHER-CIFX RE PNS-20130301.xml*.
3. Update the PROFINET IO Device firmware in your device to version 3.5.

Note also:

- SYCON.net V1.360.x.x can configure the PROFINET IO Device firmware V3.4 as well as V3.5
- netX Configuration Tool V1.0510.x.x can configure the PROFINET IO Device firmware V3.4 as well as V3.5.
- The development of the PROFINET IO Device firmware V3.4 will not be continued, but this firmware version will be delivered furthermore.

On the Communication Solutions DVD, software and manuals relating to both firmware versions V3.4 and V3.5 are available:

	<b>PROFINET IO-Device V3.4</b> Directory on the DVD \ File:	<b>PROFINET IO-Device V3.5</b> Directory on the DVD \ File:
<b>Firmware</b>	<i>Firmware\CIFX\cifxps.nxf</i>	<i>Firmware\CIFX\PNS V3.5.X\cifxps.nxf</i>
<b>Header</b>	<i>Examples and API\0. Header\Firmware\PROFINET IO Device V3.4.X</i>	<i>Examples and API\0. Header\Firmware\PROFINET IO Device V3.5.X</i>
<b>GSDML</b>	<i>EDS\PROFINET\3.4.X\GSDML-V2.3-HILSCHER-CIFX RE PNS-20130225.xml</i>	<i>EDS\PROFINET\3.5.X\GSDML-V2.3-HILSCHER-CIFX RE PNS-20130301.xml</i>
<b>Protocol API</b>	<i>Documentation\7. Programming Manuals\EN\3. Protocol API\PROFINET IO Device V3.4\PROFINET IO Device Protocol API 13 EN.pdf</i> <i>TCP IP - Packet Interface API 13 EN.pdf</i>	<i>Documentation\7. Programming Manuals\EN\3. Protocol API\PROFINET IO Device V3.5\PROFINET IO Device V3.5 Protocol API 06 EN.pdf</i> <i>PROFINET IO Device - Migration from Version 3.4 to 3.5 MG 03 EN.pdf</i>

Table 6: PROFINET IO-Device Firmware Version 3.4 and 3.5, Header, GSDML and Protocol API Manual



### 1.2.3.3 EtherCAT Slave Firmware Versions 2.5 and 4.2

The EtherCAT Slave firmware was revised and completed and is available in version 4.2 since the third quarter 2013.

Use the EtherCAT Slave firmware in version 4.2 for a new installation, when you create or develop your application program for the first time.

If you want to change in an existing system from the EtherCAT Slave firmware version 2.5 to the version 4.2, note the following guidelines:

1. Customize your application program according to the Migration Guide **EtherCAT Slave, Migration from V2.5 to V4.2**.



If you want to change to V4.2, please check in the Migration Guide **EtherCAT Slave, Migration from V2.5 to V4.2** which changes are necessary in the application program in order to use version 4.2.

2. Adjust the configuration of your EtherCAT Master device. Use the new XML file in the configuration software of the EtherCAT Master for this: *Hilscher CIFX RE ECS V4.2.X.xml*.
3. Update the EtherCAT Slave firmware in your device to version 4.2.

Note also:

- SYCON.net V1.360.x.x can configure the EtherCAT Slave firmware V2.5 as well as V4.2.10.0 and higher.
- netX Configuration Tool V1.0510.x.x can configure the EtherCAT Slave firmware V2.5 as well as V4.2.
- The development of the EtherCAT Slave firmware V2.5 will not be continued, but this firmware version will be delivered furthermore.

On the Communication Solutions DVD, software and manuals relating to both firmware versions V2.5 and V4.2 are available:

	<b>EtherCAT-Slave V2.5</b> Directory on the DVD \ File:	<b>EtherCAT-Slave V4.2</b> Directory on the DVD \ File:
<b>Firmware</b>	<i>Firmware\CIFX\cifxecs.nxf</i>	<i>Firmware\CIFX\ECS V4.X\cifxecs.nxf</i>
<b>Header</b>	<i>Examples and API\0. Header\Firmware\EtherCAT Slave V2.5.X</i>	<i>Examples and API\0. Header\Firmware\EtherCAT Slave V4.2.X</i>
<b>XML</b>	<i>EDS\EtherCAT\Slave\V2.X\Hilscher CIFX RE ECS V2.2.X.xml</i>	<i>EDS\EtherCAT\Slave\V4.X\Hilscher CIFX RE ECS V4.2.X.xml</i>
<b>Protocol API</b>	<i>Documentation\7. Programming Manuals\EN\3. Protocol API\EtherCAT Slave V2\EtherCAT Slave Protocol API 21 EN.pdf</i>	<i>Documentation\7. Programming Manuals\EN\3. Protocol API\EtherCAT Slave V4\EtherCAT Slave V4 Protocol API 03 EN.pdf</i> <i>EtherCAT Slave - Migration from Version 2.5 to 4.2 MG 02 EN.pdf</i> <i>Object Dictionary V3 03 API EN.pdf</i>

Table 7: EtherCAT-Slave Firmware Version 2.5 and 4.2, Header, XML and Protocol API Manual

## 1.2.4 Device Description Files cifX

The Communication Solutions DVD **EDS** directory includes the device description files for the PC cards cifX. The device description file is required to configure the used Master device. The systems Open Modbus/TCP, PROFIBUS MPI and VARAN do not use device description files.

### Real-Time-Ethernet



PC Cards cifX	System	File Name of the Device Description File	
CIFX 80-RE CIFX 90-RE\F CIFX 90E-RE\F CIFX 90E-RE\ET\F CIFX 90E-RE\MR\F CIFX 90E-RE\MR\ET\F CIFX 104C-RE CIFX 104C-RE-R CIFX 104C-RE\F CIFX 104C-RE-R\F	EtherCAT Slave	For the EtherCAT Slave Firmware V2.5: <i>Hilscher cifX RE ECS V2.2.x.xml</i> (or with extension DDF)	
		For the EtherCAT Slave Firmware with V4.2.1.0 the <i>Hilscher CIFX RE ECS V4.2.X.xml</i> is provided.	
	 <b>Note!</b> If the XML file <i>Hilscher cifX RE ECS V2.2.x.xml</i> is used/re-installed, the firmware must be used/re-installed at the Version 2.5.x.		
	EtherNet/IP Adapter (Slave)	<i>HILSCHER CIFX-RE EIS V1.1.EDS</i>	
	EtherNet/IP Scanner (Master)	<i>HILSCHER CIFX-RE EIM V1.0.eds</i>	
	 <b>Note!</b> The description files for the EtherNet/IP Master device is needed, when an additional EtherNet/IP Master device shall communicate to a Hilscher EtherNet/IP Master device via EtherNet/IP.		
	POWERLINK-Controlled-Node/Slave	<i>00000044_CIFX RE PLS.xdd</i>	
	PROFINET IO-Device	For the PROFINET IO Device Firmware V3.4: <i>GSDML-V2.3-HILSCHER-CIFX RE PNS-20130225.xml</i>	
		For the PROFINET IO Device Firmware with V3.5.13.1 the <i>GSDML-V2.3-HILSCHER-CIFX RE PNS-20130301.xml</i> is provided.	
	sercos Slave	<i>Hilscher CIFX RE S3S FixCFG FSPIO Default.xml</i> , <i>Hilscher CIFX RE S3S VarCFG FSPDrive.xml</i>	
 <b>Note!</b> If you use a sercos Master which is using SDDML files for configuration, and one of the defaults for vendor code, device ID, input data size or output data size was changed, then you have to export a new updated SDDML file from SYCON.net and import this SDDML file into the configuration software for the sercos Master.			

Table 8: Device Description Files for PC Cards cifX Real-Time-Ethernet

**Fieldbus**

PC Cards cifX	System	File Name of the Device Description File
CIFX 80-DP CIFX 90-DP\F CIFX 90E-DP\F CIFX 90E-DP\ET\F CIFX 90E-DP\MR\F CIFX 90E-DP\MR\ET\F CIFX 90E-2DP\ET\F CIFX 90E-2DP\MR\ET\F CIFX 104C-DP CIFX 104C-DP-R CIFX 104C-DP\F CIFX 104C-DP-R\F	PROFIBUS DP Slave	<i>HIL_0B69.GSD</i>
CIFX 90E-2DP\CO\ET\F CIFX 90E-2DP\CO\MR\ET\F	PROFIBUS DP Slave CANopen Slave	<i>HIL_0B69.GSD</i> <i>CIFX CO COS.eds</i>
CIFX 90E-2DP\DN\ET\F CIFX 90E-2DP\DN\MR\ET\F	PROFIBUS DP Slave DeviceNet Slave	<i>HIL_0B69.GSD</i> <i>CIFX_DN_DNS.EDS</i>
CIFX 80-CO CIFX 90-CO\F CIFX 90E-CO\F CIFX 90E-CO\ET\F CIFX 90E-CO\MR\F CIFX 90E-CO\MR\ET\F CIFX 90E-2CO\ET\F CIFX 90E-2CO\MR\ET\F CIFX 104C-CO CIFX 104C-CO-R CIFX 104C-CO\F CIFX 104C-CO-R\F	CANopen-Slave	<i>CIFX CO COS.eds</i>
CIFX 90E-2CO\DN\ET\F CIFX 90E-2CO\DN\MR\ET\F	CANopen Slave DeviceNet Slave	<i>CIFX CO COS.eds</i> <i>CIFX_DN_DNS.EDS</i>
CIFX 80-DN CIFX 90-DN\F CIFX 90E-DN\F CIFX 90E-DN\ET\F CIFX 90E-DN\MR\F CIFX 90E-DN\MR\ET\F CIFX 90E-2DN\ET\F CIFX 90E-2DN\MR\ET\F CIFX 104C-DN CIFX 104C-DN-R CIFX 104C-DN\F CIFX 104C-DN-R\F	DeviceNet Slave	<i>CIFX_DN_DNS.EDS</i>
CIFX 90-CC\F CIFX 90E-CC\ET\F CIFX 90E-CC\MR\ET\F CIFX 104C-CC\F	CC-Link Slave	<i>cifx-ccs_1.csp, cifx-ccs_2.csp, cifx-ccs_3.csp, cifx-ccs_4.csp,</i> (for one, two, three or four Remote Device Station), <i>cifx-ccs_io.csp</i> (for one Remote IO Device Station)

Table 9: Device Description Files for PC Cards cifX Fieldbus

## 1.3 Legal Notes

### 1.3.1 Copyright

© Hilscher, 2008-2015, Hilscher Gesellschaft für Systemautomation mbH

All rights reserved.

The images, photographs and texts in the accompanying material (user manual, accompanying texts, documentation, etc.) are protected by German and international copyright law as well as international trade and protection provisions. You are not authorized to duplicate these in whole or in part using technical or mechanical methods (printing, photocopying or other methods), to manipulate or transfer using electronic systems without prior written consent. You are not permitted to make changes to copyright notices, markings, trademarks or ownership declarations. The included diagrams do not take the patent situation into account. The company names and product descriptions included in this document may be trademarks or brands of the respective owners and may be trademarked or patented. Any form of further use requires the explicit consent of the respective rights owner.

### 1.3.2 Important Notes

The user manual, accompanying texts and the documentation were created for the use of the products by qualified experts, however, errors cannot be ruled out. For this reason, no guarantee can be made and neither juristic responsibility for erroneous information nor any liability can be assumed. Descriptions, accompanying texts and documentation included in the user manual do not present a guarantee nor any information about proper use as stipulated in the contract or a warranted feature. It cannot be ruled out that the user manual, the accompanying texts and the documentation do not correspond exactly to the described features, standards or other data of the delivered product. No warranty or guarantee regarding the correctness or accuracy of the information is assumed.

We reserve the right to change our products and their specification as well as related user manuals, accompanying texts and documentation at all times and without advance notice, without obligation to report the change. Changes will be included in future manuals and do not constitute any obligations. There is no entitlement to revisions of delivered documents. The manual delivered with the product applies.

Hilscher Gesellschaft für Systemautomation mbH is not liable under any circumstances for direct, indirect, incidental or follow-on damage or loss of earnings resulting from the use of the information contained in this publication.

### 1.3.3 Exclusion of Liability

The software was produced and tested with utmost care by Hilscher Gesellschaft für Systemautomation mbH and is made available as is. No warranty can be assumed for the performance and flawlessness of the software for all usage conditions and cases and for the results produced when utilized by the user. Liability for any damages that may result from the use of the hardware or software or related documents, is limited to cases of intent or grossly negligent violation of significant contractual obligations. Indemnity claims for the violation of significant contractual obligations are limited to damages that are foreseeable and typical for this type of contract.

It is strictly prohibited to use the software in the following areas:

- for military purposes or in weapon systems;
- for the design, construction, maintenance or operation of nuclear facilities;
- in air traffic control systems, air traffic or air traffic communication systems;
- in life support systems;
- in systems in which failures in the software could lead to personal injury or injuries leading to death.

We inform you that the software was not developed for use in dangerous environments requiring fail-proof control mechanisms. Use of the software in such an environment occurs at your own risk. No liability is assumed for damages or losses due to unauthorized use.

### 1.3.4 Warranty

Although the hardware and software was developed with utmost care and tested intensively, Hilscher Gesellschaft für Systemautomation mbH does not guarantee its suitability for any purpose not confirmed in writing. It cannot be guaranteed that the hardware and software will meet your requirements, that the use of the software operates without interruption and that the software is free of errors. No guarantee is made regarding infringements, violations of patents, rights of ownership or the freedom from interference by third parties. No additional guarantees or assurances are made regarding marketability, freedom of defect of title, integration or usability for certain purposes unless they are required in accordance with the law and cannot be limited. Warranty claims are limited to the right to claim rectification.

### 1.3.5 Export Regulations

The delivered product (including the technical data) is subject to export or import laws as well as the associated regulations of different countries, in particular those of Germany and the USA. The software may not be exported to countries where this is prohibited by the United States Export Administration Act and its additional provisions. You are obligated to comply with the regulations at your personal responsibility. We wish to inform you that you may require permission from state authorities to export, re-export or import the product.

### 1.3.6 Registered Trademarks

Windows<sup>®</sup> XP, Windows<sup>®</sup> Vista, Windows<sup>®</sup> 7 and Windows<sup>®</sup> 8 are registered trademarks of Microsoft Corporation.

Linux is a registered trademark of Linus Torvalds.

QNX is a registered trademark of QNX Software Systems, Ltd.

VxWorks is a registered trademark of Wind River Systems, Inc.

IntervalZero RTX<sup>™</sup> is a trademark of IntervalZero.

Adobe-Acrobat<sup>®</sup> is a registered trademark of the Adobe Systems Incorporated.

CANopen<sup>®</sup> is a registered trademark of CAN in AUTOMATION - International Users and Manufacturers Group e.V (CiA), Nürnberg.

CC-Link is a registered trademark of Mitsubishi Electric Corporation, Tokyo, Japan.

DeviceNet<sup>™</sup> and EtherNet/IP<sup>™</sup> are trademarks of ODVA (Open DeviceNet Vendor Association, Inc).

EtherCAT<sup>®</sup> is a registered trademark and a patented technology of Beckhoff Automation GmbH, Verl, Germany, formerly Elektro Beckhoff GmbH.

Modbus is a registered trademark of Schneider Electric.

POWERLINK is a registered trademark of B&R, Bernecker + Rainer Industrie-Elektronik Ges.m.b.H, Eggelsberg, Austria

PROFIBUS<sup>®</sup> and PROFINET<sup>®</sup> are registered trademarks of PROFIBUS & PROFINET International (PI), Karlsruhe.

sercos and sercos interface are registered trademarks of sercos international e. V., Suessen, Germany.

PCI<sup>™</sup>, PCI EXPRESS<sup>®</sup> and PCIe<sup>®</sup> or MINI PCI<sup>™</sup> are trademarks or registered trademarks of the Peripheral Component Interconnect Special Interest Group (PCI-SIG).

CompactPCI<sup>™</sup> is a trademark of the PCI Industrial Manufacturers Group (PICMG).

All other mentioned trademarks are property of their respective legal owners.

### 1.3.7 EtherCAT Disclaimer

EtherCAT® is registered trademark and patented technology, licensed by Beckhoff Automation GmbH, Germany.



To get details and restrictions regarding using the EtherCAT technology refer to the following documents:

- “EtherCAT Marking rules”
- “EtherCAT Conformance Test Policy”
- “EtherCAT Vendor ID Policy”

These documents are available at the ETG homepage [www.ethercat.org](http://www.ethercat.org) or directly over [info@ethercat.org](mailto:info@ethercat.org).

A summary over Vendor ID, Conformance test, Membership and Network Logo can be found within the appendix section of this document under section *EtherCAT Summary over Vendor ID, Conformance test, Membership and Network Logo* on page 238.

### 1.3.8 Obligation to read and understand the Manual



#### Important!

- To avoid personal injury and to avoid property damage to your system or to your PC card, you must read and understand all instructions in the manual and all accompanying texts to your PC card, before installing and operating your PC card.
- First read the **Safety Instructions** in the safety chapter.
- Obey to all **Safety Messages** in the manual.
- Keep the product DVD providing the product manuals.

## 1.4 Licenses

If a PC card cifX is used as a Slave, neither for the firmware nor for the configuration software SYCON.net a license is required.

Licenses will be required if the PC card cifX is used with

- a firmware with master functionality\*.

\* The master license includes the PC card cifX operating as master and the license for the configuration software SYCON.net for the respective cifX.

### 1.4.1 License Note about VARAN Client

In order to use the PC card cifX with VARAN, you need a license which you can acquire at the VNO (VARAN Bus-Nutzerorganisation, Bürmooser Straße 10, A-5112 Lamprechtshausen, [info@varan-bus.net](mailto:info@varan-bus.net)) after getting a member of VON.

The license as well as the Vendor ID and the Device ID can be adjusted with the SYCON.net configuration software or with the netX Configuration Tool.

## 2 Safety

### 2.1 General Note

The documentation in the form of a user manual, an operating instruction manual or other manual types, as well as the accompanying texts have been created for the use of the products by educated personnel. When using the products, all Safety Messages, Safety Messages, Property Damage Messages and all valid legal regulations have to be obeyed. Technical knowledge is presumed. The user has to assure that all legal regulations are obeyed.

### 2.2 Intended Use

The **PC cards cifX** described in this user manual are PC cards for the Real-Time Ethernet or fieldbus communication. Depending from the loaded firmware, the Real-Time Ethernet or fieldbus systems listed in the following table can be realized using the respective PC card cifX.

PC Cards cifX	Real-Time Ethernet System	PC Cards cifX	Fieldbus System	
CIFX 80-RE CIFX 90-RE\F CIFX 90E-RE\F CIFX 90E-RE\ET\F CIFX 90E-RE\MR\F CIFX 90E-RE\MR\ET\F CIFX 104C-RE CIFX 104C-RE-R CIFX 104C-RE\F CIFX 104C-RE-R\F	EtherCAT Master, EtherCAT Slave	CIFX 80-CO CIFX 90-CO\F CIFX 90E-CO\F CIFX 90E-CO\ET\F CIFX 90E-CO\MR\F CIFX 90E-CO\MR\ET\F CIFX 90E-2CO\ET\F CIFX 90E-2CO\MR\ET\F CIFX 104C-CO CIFX 104C-CO-R CIFX 104C-CO\F CIFX 104C-CO-R\F	CANopen Master, CANopen Slave	
	EtherNet/IP Scanner (Master), EtherNet/IP Scanner (Slave)			
	Open Modbus/TCP			
	POWERLINK Controlled Node/Slave			
	PROFINET IO-Controller (Master), PROFINET IO-Device (Slave)			
CIFX 80-DN CIFX 90-DN\F CIFX 90E-DN\F CIFX 90E-DN\ET\F CIFX 90E-DN\MR\F CIFX 90E-DN\MR\ET\F CIFX 104C-DN CIFX 104C-DN-R CIFX 104C-DN\F CIFX 104C-DN-R\F	sercos Master, sercos Slave	CIFX 90E-2CO\DN\ET\F CIFX 90E-2CO\DN\MR\ET\F	CANopen Slave DeviceNet Slave	
	VARAN Client (Slave)			
	DeviceNet Master, DeviceNet Slave			
PC Cards cifX	Fieldbus System	CIFX 90E-2DP\ET\F CIFX 90E-2DP\MR\ET\F	PROFIBUS DP Master, PROFIBUS DP Slave, PROFIBUS MPI Device	
CIFX 80-DP CIFX 90-DP\F CIFX 90E-DP\F CIFX 90E-DP\ET\F CIFX 90E-DP\MR\F CIFX 90E-DP\MR\ET\F CIFX 104C-DP CIFX 104C-DP-R CIFX 104C-DP\F CIFX 104C-DP-R\F	PROFIBUS DP Master, PROFIBUS DP Slave			
	CIFX 90E-2DP\CO\ET\F CIFX 90E-2DP\CO\MR\ET\F			PROFIBUS DP Slave CANopen Slave
	CIFX 90E-2DP\DN\ET\F CIFX 90E-2DP\DN\MR\ET\F			PROFIBUS DP Slave DeviceNet Slave
CIFX 90E-2DP\CO\ET\F CIFX 90E-2DP\CO\MR\ET\F	PROFIBUS DP Slave DeviceNet Slave	CIFX 90-CC\F CIFX 90E-CC\ET\F CIFX 90E-CC\MR\ET\F CIFX 104C-CC\F	CC-Link Slave	

Table 10: PC Cards cifX and the Real-Time Ethernet or Fieldbus Systems realizable



The **AIFX Assembly Interfaces** are each attached to the respective basic card for the PC card cifX via a cable connector (label „F“). This way the PC card cifX is equipped with a Real-Time Ethernet or fieldbus interface and for the PC card cifX PCI-104 in addition with a diagnostic interface.

AIFX	PC Cards cifX with AIFX Assembly Interface
AIFX-RE	CIFX 90-RE\F, CIFX 90E-RE\F, CIFX 90E-RE\ET\F, CIFX 90E-RE\MR\F, CIFX 90E-RE\MR\ET\F, CIFX 104C-RE\F, CIFX 104C-RE-R\F
AIFX-DP	CIFX 90-DP\F, CIFX 90E-DP\F, CIFX 90E-DP\ET\F, CIFX 90E-DP\MR\F, CIFX 90E-DP\MR\ET\F, CIFX 90E-2DP\ET\F, CIFX 90E-2DP\MR\ET\F, CIFX 104C-DP\F, CIFX 104C-DP-R\F
AIFX-DP, AIFX-CO	CIFX 90E-2DP\CO\ET\F, CIFX 90E-2DP\CO\MR\ET\F
AIFX-DP, AIFX-DN	CIFX 90E-2DP\DN\ET\F, CIFX 90E-2DP\DN\MR\ET\F
AIFX-CO	CIFX 90-CO\F, CIFX 90E-CO\F, CIFX 90E-CO\ET\F, CIFX 90E-CO\MR\F, CIFX 90E-CO\MR\ET\F, CIFX 90E-2CO\ET\F, CIFX 90E-2CO\MR\ET\F, CIFX 104C-CO\F, CIFX 104C-CO-R\F
AIFX-CO, AIFX-DN	CIFX 90E-2CO\DN\ET\F CIFX 90E-2CO\DN\MR\ET\F
AIFX-DN	CIFX 90-DN\F, CIFX 90E-DN\F, CIFX 90E-DN\ET\F, CIFX 90E-DN\MR\F, CIFX 90E-DN\MR\ET\F, CIFX 90E-2DN\ET\F, CIFX 90E-2DN\MR\ET\F, CIFX 104C-DN\F, CIFX 104C-DN-R\F
AIFX-CC	CIFX 90-CC\F, CIFX 90E-CC\ET\F, CIFX 90E-CC\MR\ET\F, CIFX 104C-CC\F
AIFX-DIAG (optional)	CIFX 104C-RE\F, CIFX 104C-RE-R\F, CIFX 104C-DP\F, CIFX 104C-DP-R\F, CIFX 104C-CO\F, CIFX 104C-CO-R\F, CIFX 104C-DN\F, CIFX 104C-DN-R\F CIFX 104C-CC\F

Table 11: PC Cards cifX with AIFX Assembly Interface

## 2.3 Personnel Qualification

The PC card cifX must only be installed, configured and removed by qualified personnel. Job-specific technical skills for people professionally working with electricity must be present concerning the following topics:

- Safety and health at work
- Mounting and connecting of electrical equipment
- Measurement and Analysis of electrical functions and systems
- Evaluation of the safety of electrical systems and equipment
- Installing and Configuring IT systems

## 2.4 Safety Instructions to avoid Personal Injury

To ensure your own personal safety and to avoid personal injury, you necessarily must read, understand and follow the following safety instructions and safety messages in this manual about danger causing personal injury, before you install and operate your PC card cifX.

### 2.4.1 Electrical Shock Hazard

The danger of a lethal electrical shock caused by parts with more than 50V may occur if you open the PC cabinet to install the PC card cifX.

- HAZARDOUS VOLTAGE is present inside of the PC or of the connecting device, into which the PC card cifX is integrated. Strictly obey to all safety rules provided by the device's manufacturer in the documentation!
- First disconnect the power plug of the PC or of the connecting device, before you open the cabinet.
- Make sure, that the power supply is off at the PC or at the connecting device.
- Open the PC cabinet and install or remove the PC card cifX only after disconnecting power.

An electrical shock is the result of a current flowing through the human body. The resulting effect depends on the intensity and duration of the current and on its path through the body. Currents in the range of approximately ½ mA can cause effects in persons with good health, and indirectly cause injuries resulting from startle responses. Higher currents can cause more direct effects, such as burns, muscle spasms, or ventricular fibrillation.

In dry conditions permanent voltages up to approximately 42.4 V peak or 60 V DC are not considered as dangerous if the contact area is equivalent to the size of a human hand.

Reference Safety [S2]

## 2.5 Safety Instructions to avoid Property Damage

To avoid property damage respectively device destruction to the PC card cifX and to your system, you necessarily must read, understand and follow the following safety instructions and safety messages in this manual about danger causing property damage, before you install and operate your PC card.

### 2.5.1 Device Destruction by exceeding allowed Supply Voltage

To avoid device destruction due to high supply voltage to your PC card cifX, you must observe the following instructions. These instructions apply to all PC cards cifX described in this manual.

The PC card cifX may only be operated with the specified supply voltage. Make sure that the limits of the allowed range for the supply voltage are not exceeded. A supply voltage above the upper limit can cause severe damage to the PC card cifX! A supply voltage below the lower limit can cause malfunction in the PC card cifX. The allowed range for the supply voltage is defined by the tolerances specified in this manual.

For the PC cards listed hereafter adhere specifically: The PC card cifX

- CIFX 80-RE, CIFX 80-DP, CIFX 80-CO, CIFX 80-DN,
- CIFX 90-RE\F, CIFX 90-DP\F, CIFX 90-CO\F, CIFX 90-DN\F,
- CIFX 90E-RE\F, CIFX 90E-RE\ET\F,
- CIFX 90E-DP\F, CIFX 90E-DP\ET\F,
- CIFX 90E-CO\F, CIFX 90E-CO\ET\F,
- CIFX 90E-DN\F, CIFX 90E-DN\ET\F,
- CIFX 90E-RE\MR\F, CIFX 90E-RE\MR\ET\F,
- CIFX 90E-DP\MR\F, CIFX 90E-DP\MR\ET\F,
- CIFX 90E-CO\MR\F, CIFX 90E-CO\MR\ET\F,
- CIFX 90E-DN\MR\F, CIFX 90E-DN\MR\ET\F,
- CIFX 90E-2DP\ET\F, CIFX 90E-2DP\MR\ET\F,
- CIFX 90E-2DP\CO\ET\F, CIFX 90E-2DP\CO\MR\ET\F,
- CIFX 90E-2DP\DN\ET\F, CIFX 90E-2DP\DN\MR\ET\F,
- CIFX 90E-2CO\ET\F, CIFX 90E-2CO\MR\ET\F,
- CIFX 90E-2CO\DN\ET\F, CIFX 90E-2CO\DN\MR\ET\F,
- CIFX 90E-2DN\ET\F, CIFX 90E-2DN\MR\ET\F

may not be powered by a 5V supply voltage! The PC card cifX may only be powered by a 3.3 V dc  $\pm 5\%$  supply voltage.



The data on the mandatory supply voltage for the PC cards cifX described in this manual you find in section *Power Supply and Host Interface* on page 46. There the required and permitted supply voltage is provided by device type inclusively the permitted tolerance range.

## 2.5.2 Device Destruction by exceeding allowed Signaling Voltage

To avoid device destruction due to high signal voltage to your PC card cifX, you must observe the following instructions. These instructions apply to all PC cards cifX described in this manual.

- All I/O signal pins at the PC card cifX tolerate only a specified signaling voltage!
- Operation with a signaling voltage other than the specified signaling voltage may lead to severe damage to the PC card cifX!



---

The data on the mandatory signaling voltage for the PC cards cifX described in this manual you find in the section *Power Supply and Host Interface* on page 46. There the required and permitted signaling voltage is provided by device type.

---

## 2.5.3 Electrostatically sensitive Devices

This equipment is sensitive to electrostatic discharge, which cause internal damage and affect normal operation. Therefore adhere to the necessary safety precautions for components that are vulnerable with electrostatic discharge if you install or replace your device. Follow the guidelines listed hereafter when you handle this equipment:

- Touch a grounded object to discharge potential static.
- Wear an approved grounding wriststrap.
- Do not touch connectors or pins on the PC card cifX.
- Do not touch circuit components inside the equipment.
- If available, use a static-safe workstation.
- When not in use, store the equipment in appropriate static-safe packaging.

Reference Safety [S3]

## 2.6 Labeling of Safety Messages

- The **Section Safety Messages** at the beginning of a chapter are pinpointed particularly and highlighted by a signal word according to the degree of endangerment. The kind of danger is specified exactly by the safety message text and *optionally* by a specific safety sign.
- The **Integrated Safety Messages** within an instruction description are highlighted with a signal word according to the degree of endangerment. The kind of danger is specified exactly by the safety message text.







Signal Word	Meaning (international)	Meaning (USA)
	Indicates a direct hazard with high risk, which will have as consequence death or grievous bodily harm if it isn't avoided.	Indicates a Hazardous Situation Which if not Avoided, will Result in Death or Serious Injury.
	Indicates a possible hazard with medium risk, which will have as consequence death or (grievous) bodily harm if it isn't avoided.	Indicates a Hazardous Situation Which if not Avoided, could Result in Death or Serious Injury.
	Indicates a minor hazard with medium risk, which could have as consequence simple battery if it isn't avoided.	Indicates a Hazardous Situation Which if not Avoided, may Result in Minor or Moderate Injury.
Safety Sign	USA	Sort of Warning or Principle
		Warning of Lethal Electrical Shock
		Principle: Disconnect the Power Plug

Table 12: Signal Words and Safety Signs in Safety Messages on Personal Injury



Signal Word	Meaning (international and USA)
	Indicates a Property Damage Message.
Safety Sign	Sort of Warning or Principle
	Warning on Damages by Electrostatic Discharge
-	Example: Warning on Device Destruction due by too high supply voltage

Table 13: Signal Words and Safety Signs in Safety Messages on Property Damage

In this document all Safety Instructions and Safety Messages are designed according both to the international used safety conventions as well as to the ANSI Z535.6 standard, refer to reference safety [S1].

### 2.6.1 References Safety

- [S1] ANSI Z535.6-2006 American National Standard for Product Safety Information in Product Manuals, Instructions, and Other Collateral Materials
- [S2] IEC 60950-1, Information technology equipment - Safety - Part 1: General requirements, (IEC 60950-1:2005, modified); German Edition EN 60950-1:2006
- [S3] EN 61340-5-1 and EN 61340-5-2 as well as IEC 61340-5-1 and IEC 61340-5-2

## 3 Descriptions and Requirements

### 3.1 Description

The PC cards cifX are communication interfaces of the cifX product family of Hilscher on the basis of the communication controller netX 100 for the Real-Time Ethernet or fieldbus communication. Depending of the loaded firmware, the protocol specific PC card cifX proceeds the communication of the corresponding Real-Time Ethernet or fieldbus system.

The used Real-Time Ethernet systems are:      The used fieldbus systems are:

- EtherCAT Master
- EtherCAT Slave
- EtherNet/IP Scanner (Master)
- EtherNet/IP Adapter (Slave)
- Open Modbus/TCP
- POWERLINK-Controlled-Node/Slave
- PROFINET IO-Controller (Master)
- PROFINET IO-Device (Slave)
- sercos Master
- sercos Slave
- VARAN Client (Slave)
- PROFIBUS DP Master
- PROFIBUS DP Slave
- PROFIBUS MPI Device
- CANopen Master
- CANopen Slave
- DeviceNet Master
- DeviceNet Slave
- CC-Link Slave

The PC card cifX handles the complete data exchange between the connected Ethernet or fieldbus devices and the PC. The data exchange is proceeded via dual-port memory.

## 3.2 PC Cards cifX with integrated Interfaces

The PC cards Compact PCI CIFX 80-XX and the PC cards PCI-104 CIFX 104C-XX and CIFX 104C-XX-R provide integrated Ethernet, fieldbus or diagnostic interfaces.

### 3.2.1 PC Cards Compact PCI CIFX 80-XX

PC Card cifX	Description
<b>PC Cards Compact PCI with integrated Ethernet, fieldbus or diagnostic interface</b>	
<b>Real-Time Ethernet</b>	
CIFX 80-RE	Real-Time Ethernet Master or Slave
<b>PROFIBUS</b>	
CIFX 80-DP	PROFIBUS DP Master or Slave and PROFIBUS MPI Device
<b>CANopen</b>	
CIFX 80-CO	CANopen Master or Slave
<b>DeviceNet</b>	
CIFX 80-DN	DeviceNet Master or Slave

Table 14: PC Cards Compact PCI CIFX 80-XX

### 3.2.2 PC Cards PCI-104: CIFX 104C-XX and CIFX 104C-XX-R

PC Card cifX	Description
<b>PC Cards PCI-104 with integrated Ethernet, fieldbus or diagnostic interface</b>	
<b>Real-Time Ethernet</b>	
CIFX 104C-RE	Real-Time Ethernet Master or Slave
CIFX 104C-RE-R	Real-Time Ethernet Master or Slave (connectors at the left side)
<b>PROFIBUS</b>	
CIFX 104C-DP	PROFIBUS DP Master or Slave and PROFIBUS MPI Device
CIFX 104C-DP-R	PROFIBUS DP Master or Slave and PROFIBUS MPI Device (connectors at the left side)
<b>CANopen</b>	
CIFX 104C-CO	CANopen Master or Slave
CIFX 104C-CO-R	CANopen Master or Slave (connectors at the left side)
<b>DeviceNet</b>	
CIFX 104C-DN	DeviceNet Master or Slave
CIFX 104C-DN-R	DeviceNet Master or Slave (connectors at the left side)

Table 15: PC Cards PCI-104: CIFX 104C-XX and CIFX 104C-XX-R

## 3.3 PC Cards cifX with AIFX Assembly Interfaces

### 3.3.1 The Label „\F“ in the Device Name

The PC cards cifX including the label “\F” in its device name are composed of a basic card and an assembly interface AIFX.

- The basic cards CIFX 90, CIFX 90E, CIFX 90E\ET, CIFX 90E\MR and, CIFX 90E\MR\ET are equipped with a **Cable Connector Ethernet**, to connect the Ethernet assembly interface (AIFX-RE) in addition they are equipped with a **Cable Connector Fieldbus**, to alternatively connect the PROFIBUS assembly interface (AIFX-DP), CANopen (AIFX-CO), DeviceNet (AIFX-DN) or CC-Link (AIFX-CC\*).  
(\*only for CIFX 90, CIFX 90E\ET and CIFX 90E\MR\ET)
- The basic cards CIFX 104C-RE\F and CIFX 104C-RE-R\F are equipped with a **Cable Connector Ethernet**, to connect the Ethernet assembly interface (AIFX-RE).
- The basic cards CIFX 90E-2FB\ET and CIFX 90E-2FB\MR\ET are equipped with **Cable Connectors Fieldbus**, to connect two PROFIBUS assembly interfaces (AIFX-DP), CANopen (AIFX-CO) or DeviceNet (AIFX-DN); (Note: 'FB' stands for ‚Fieldbus‘)
- The basic cards CIFX 104C-FB\F and CIFX 104C-FB-R\F are equipped with a **Cable Connector Fieldbus**, to connect the PROFIBUS assembly interface (AIFX-DP), CANopen (AIFX-CO), DeviceNet (AIFX-DN) or CC-Link (AIFX-CC\*); (\*only for CIFX 104C-FB\F; Note: 'FB' stands for ‚Fieldbus‘.)
- The basic cards CIFX 104C-RE\F, CIFX 104C-RE-R\F, CIFX 104C-FB\F and CIFX 104C-FB-R\F are additionally equipped with a **Cable Connector DIAG**, to optionally connect the diagnostic assembly interface (AIFX-DIAG).



---

**Important!** Operating the PC cards cifX Mini PCI, Mini PCI Express or PCI-104 with AIFX assembly interface (label “\F” in the device name) requires proper connection of the Ethernet (AIFX-RE), PROFIBUS (AIFX-DP), CANopen (AIFX-CO), DeviceNet (AIFX-DN) or CC-Link (AIFX-CC) assembly interface to the basic card! For 2-channel devices both assembly interfaces must be connected.

---



### 3.3.2 PC Cards Mini PCI CIFX 90-XX\F

PC Card cifX	Description
<b>PC Cards Mini PCI with AIFX Assembly Interface</b>	
<b>Real-Time Ethernet</b>	
CIFX 90-RE\F	<b>Real-Time Ethernet Master or Slave</b> - Basic card CIFX 90 and - Ethernet assembly interface (AIFX-RE).
<b>PROFIBUS</b>	
CIFX 90-DP\F	<b>PROFIBUS DP Master or Slave or PROFIBUS MPI Device</b> - Basic card CIFX 90 and - PROFIBUS assembly interface (AIFX-DP).
<b>CANopen</b>	
CIFX 90-CO\F	<b>CANopen Master or Slave</b> - Basic card CIFX 90 and - CANopen assembly interface (AIFX-CO).
<b>DeviceNet</b>	
CIFX 90-DN\F	<b>DeviceNet Master or Slave</b> - Basic card CIFX 90 and - DeviceNet assembly interface (AIFX-DN).
<b>CC-Link</b>	
CIFX 90-CC\F	<b>CC-Link Slave</b> - Basic card CIFX 90 and - CC-Link assembly interface (AIFX-CC).

Table 16: PC Cards Mini PCI CIFX 90-XX\F



**Note:** The device height and the power input of the PC cards CIFX 90-RE\F, CIFX 90-DP\F, CIFX 90-CO\F, CIFX 90-DN\F and CIFX 90-DN\F do not comply with the standard specifications.

### 3.3.3 PC Cards Mini PCI Express CIFX 90E-XX\F

PC Card cifX	Description
<b>PC Cards Mini PCI Express with AIFX Assembly Interface</b>	
<b>Real-Time Ethernet</b>	
CIFX 90E-RE\F	<b>Real-Time Ethernet Master or Slave</b> - Basic card CIFX 90E and - Ethernet assembly interface (AIFX-RE).
<b>PROFIBUS</b>	
CIFX 90E-DP\F	<b>PROFIBUS DP Master or Slave or PROFIBUS MPI Device</b> - Basic card CIFX 90E and - PROFIBUS assembly interface (AIFX-DP).
<b>CANopen</b>	
CIFX 90E-CO\F	<b>CANopen Master or Slave</b> - Basic card CIFX 90E and - CANopen assembly interface (AIFX-CO).
<b>DeviceNet</b>	
CIFX 90E-DN\F	<b>DeviceNet Master or Slave</b> - Basic card CIFX 90E and - DeviceNet assembly interface (AIFX-DN).

Table 17: PC Cards Mini PCI Express CIFX 90E-XX\F



**Note:** The device height and the power input of the PC cards CIFX 90E-RE\F, CIFX 90E-DP\F, CIFX 90E-CO\F and CIFX 90E-DN\F do not comply with the standard specifications.

### 3.3.4 PC Cards cifX Mini PCI Express CIFX 90E-XX\ET\F

PC Card cifX	Description
<b>PC Cards Mini PCI Express with AIFX Assembly Interface and enlarged Temperature Range ,ET'</b>	
<b>Real-Time Ethernet</b>	
CIFX 90E-RE\ET\F	<b>Real-Time Ethernet Master or Slave</b> - Basic card CIFX 90E\ET and - Ethernet assembly interface (AIFX-RE).
<b>PROFIBUS</b>	
CIFX 90E-DP\ET\F	<b>PROFIBUS DP Master or Slave or PROFIBUS MPI Device</b> - Basic card CIFX 90E\ET and - PROFIBUS assembly interface (AIFX-DP).
<b>CANopen</b>	
CIFX 90E-CO\ET\F	<b>CANopen Master or Slave</b> - Basic card CIFX 90E\ET and - CANopen assembly interface (AIFX-CO).
<b>DeviceNet</b>	
CIFX 90E-DN\ET\F	<b>DeviceNet Master or Slave</b> - Basic card CIFX 90E\ET and - DeviceNet assembly interface (AIFX-DN).
<b>CC-Link</b>	
CIFX 90E-CC\ET\F	<b>CC-Link Slave</b> - Basic card CIFX 90E\ET and - CC-Link assembly interface (AIFX-CC).

Table 18: PC Cards Mini PCI Express CIFX 90E-XX\ET\F



**Note:** For the PC cards CIFX 90E-RE\ET\F, CIFX 90E-DP\ET\F, CIFX 90E-CO\ET\F, CIFX 90E-DN\ET\F and CIFX 90E-CC\ET\F the following is valid:  
**(1)** The PC cards can be used in an enlarged temperature range from -20°C to +70°C.  
**(2)** The device height and the power input of the PC cards do not comply with the standard specifications.

### 3.3.5 PC Cards cifX Mini PCI Express (2 Channels) CIFX 90E-2XX\ET\F, CIFX 90E-2XX\XX\ET\F

PC Card cifX	Description
<b>PC Cards Mini PCI Express (2 channels) with AIFX Assembly Interface and enlarged Temperature Range ,ET'</b>	
<b>PROFIBUS</b>	
CIFX 90E-2DP\ET\F	<b>PROFIBUS DP Master or Slave</b> - Basic card CIFX 90E-2FB\ET and - 2 x PROFIBUS assembly interface (AIFX-DP).
<b>PROFIBUS, CANopen</b>	
CIFX 90E-2DP\CO\ET\F	<b>PROFIBUS DP Master or Slave and CANopen Master or Slave</b> - Basic card CIFX 90E-2FB\ET, - Cable Connector X3: PROFIBUS assembly interface (AIFX-DP) and - Cable Connector X4: CANopen assembly interface (AIFX-CO).
<b>PROFIBUS, DeviceNet</b>	
CIFX 90E-2DP\DN\ET\F	<b>PROFIBUS DP Master or Slave and DeviceNet Master or Slave</b> - Basic card CIFX 90E-2FB\ET, - Cable Connector X3: PROFIBUS assembly interface (AIFX-DP) and - Cable Connector X4: DeviceNet assembly interface (AIFX-DN).
<b>CANopen</b>	
CIFX 90E-2CO\ET\F	<b>CANopen Master or Slave</b> - Basic card CIFX 90E-2FB\ET and - 2 x CANopen assembly interface (AIFX-CO).
<b>CANopen, DeviceNet</b>	
CIFX 90E-2CO\DN\ET\F	<b>CANopen Master or Slave and DeviceNet Master or Slave</b> - Basic card CIFX 90E-2FB\ET, - Cable Connector X3: CANopen assembly interface (AIFX-CO) and - Cable Connector X4: DeviceNet assembly interface (AIFX-DN).
<b>DeviceNet</b>	
CIFX 90E-2DN\ET\F	<b>DeviceNet-Master or -Slave</b> - Basic card CIFX 90E-2FB\ET and - 2 x DeviceNet assembly interface (AIFX-DN).

Table 19: PC Cards Mini PCI Express (2 Channels) CIFX 90E-2XX\ET\F, CIFX 90E-2XX\XX\ET\F



**Note:** For the PC cards CIFX 90E-2DP\ET\F, CIFX 90E-2DP\CO\ET\F, CIFX 90E-2DP\DN\ET\F, CIFX 90E-2CO\ET\F, CIFX 90E-2CO\DN\ET\F and CIFX 90E-2DN\ET\F the following is valid:

- (1) The PC cards can be used in an enlarged temperature range from -20°C to +70°C.
- (2) The device height and the power input of the PC cards do not comply with the standard specifications.

### 3.3.6 PC Cards Mini PCI Express CIFX 90E-XX\MR\F

PC Card cifX	Description
<b>PC Cards Mini PCI Express with AIFX Assembly Interface and additional MRAM ,MR'</b>	
<b>Real-Time Ethernet</b>	
CIFX 90E-RE\MR\F	<b>Real-Time Ethernet Master or Slave</b> - Basic card CIFX 90E\MR and - Ethernet assembly interface (AIFX-RE).
<b>PROFIBUS</b>	
CIFX 90E-DP\MR\F	<b>PROFIBUS DP Master or Slave or PROFIBUS MPI Device</b> - Basic card CIFX 90E\MR and - PROFIBUS assembly interface (AIFX-DP).
<b>CANopen</b>	
CIFX 90E-CO\MR\F	<b>CANopen Master or Slave</b> - Basic card CIFX 90E\MR and - CANopen assembly interface (AIFX-CO).
<b>DeviceNet</b>	
CIFX 90E-DN\MR\F	<b>DeviceNet Master or Slave</b> - Basic card CIFX 90E\MR and - DeviceNet assembly interface (AIFX-DN).

Table 20: PC Cards Mini PCI Express CIFX 90E-XX\MR\F



**Note:** For the PC cards CIFX 90E-RE\MR\F, CIFX 90E-DP\MR\F, CIFX 90E-CO\MR\F and CIFX 90E-DN\MR\F the following is valid:

- (1) The PC cards are equipped with an MRAM (128Kbyte = 64K Words). For further information refer to section *PC Cards cifX with additional MRAM* on page 42.
- (2) The device height and the power input of the PC cards do not comply with the standard specifications.

### 3.3.7 PC Cards Mini PCI Express CIFX 90E-XX\MR\ET\F

PC Card cifX	Description
<b>PC Cards Mini PCI Express with AIFX Assembly Interface, additional MRAM ,MR' and enlarged Temperature Range ,ET'</b>	
<b>Real-Time Ethernet</b>	
CIFX 90E-RE\MR\ET\F	<b>Real-Time Ethernet Master or Slave</b> - Basic card CIFX 90E\MR\ET and - Ethernet assembly interface (AIFX-RE).
<b>PROFIBUS</b>	
CIFX 90E-DP\MR\ET\F	<b>PROFIBUS DP Master or Slave or PROFIBUS MPI Devicet</b> - Basic card CIFX 90E\MR\ET and - PROFIBUS assembly interface (AIFX-DP).
<b>CANopen</b>	
CIFX 90E-CO\MR\ET\F	<b>CANopen Master or Slave</b> - Basic card CIFX 90E\MR\ET and - CANopen assembly interface (AIFX-CO).
<b>DeviceNet</b>	
CIFX 90E-DN\MR\ET\F	<b>DeviceNet Master or Slave</b> - Basic card CIFX 90E\MR\ET and - DeviceNet assembly interface (AIFX-DN).
<b>CC-Link</b>	
CIFX 90E-CC\MR\ET\F	<b>CC-Link Slave</b> - Basic card CIFX 90E\MR\ET and - CC-Link assembly interface (AIFX-CC).

Table 21: PC Cards Mini PCI Express CIFX 90E-XX\MR\ET\F



**Note:** For the PC cards CIFX 90E-RE\MR\ET\F, CIFX 90E-DP\MR\ET\F, CIFX 90E-CO\MR\ET\F, CIFX 90E-DN\MR\ET\F and CIFX 90E-CC\MR\ET\F the following is valid:

- (1) The PC cards are equipped with an MRAM (128Kbyte = 64K Words). For further information refer to section *PC Cards cifX with additional MRAM* on page 42.
- (2) The PC cards can be used in an enlarged temperature range from -20 °C to +70 °C.
- (3) The device height and the power input of the PC cards do not comply with the standard specifications.

### 3.3.8 PC Cards cifX Mini PCI Express (2 Channels) CIFX 90E-2XX\MR\ET\F, CIFX 90E-2XX\XX\MR\ET\F

PC Card cifX	Description
<b>PC Cards Mini PCI Express (2 channels) with AIFX Assembly Interface, additional MRAM ,MR' and enlarged Temperature Range ,ET'</b>	
<b>PROFIBUS</b>	
CIFX 90E-2DP\MR\ET\F	<b>PROFIBUS DP Master or Slave</b> - Basic card CIFX 90E-2FB\MR\ET and - 2 x PROFIBUS assembly interface (AIFX-DP).
<b>PROFIBUS, CANopen</b>	
CIFX 90E-2DP\CO\MR\ET\F	<b>PROFIBUS DP Master or Slave and CANopen Master or Slave</b> - Basic card CIFX 90E-2FB\MR\ET, - Cable Connector X3: PROFIBUS assembly interface (AIFX-DP) and - Cable Connector X4: CANopen assembly interface (AIFX-CO).
<b>PROFIBUS, DeviceNet</b>	
CIFX 90E-2DP\DN\MR\ET\F	<b>PROFIBUS DP Master or Slave and DeviceNet Master or Slave</b> - Basic card CIFX 90E-2FB\MR\ET, - Cable Connector X3: PROFIBUS assembly interface (AIFX-DP) and - Cable Connector X4: DeviceNet assembly interface (AIFX-DN).
<b>CANopen</b>	
CIFX 90E-2CO\MR\ET\F	<b>CANopen Master or Slave</b> - Basic card CIFX 90E-2FB\MR\ET and - 2 x CANopen assembly interface (AIFX-CO).
<b>CANopen, DeviceNet</b>	
CIFX 90E-2CO\DN\MR\ET\F	<b>CANopen Master or Slave and DeviceNet Master or Slave</b> - Basic card CIFX 90E-2FB\MR\ET, - Cable Connector X3: CANopen assembly interface (AIFX-CO) and - Cable Connector X4: DeviceNet assembly interface (AIFX-DN).
<b>DeviceNet</b>	
CIFX 90E-2DN\MR\ET\F	<b>DeviceNet-Master or -Slave</b> - Basic card CIFX 90E-2FB\MR\ET and - 2 x DeviceNet assembly interface (AIFX-DN).

Table 22: PC Cards Mini PCI Express (2 Channels) CIFX 90E-2XX\MR\ET\F, CIFX 90E-2XX\XX\MR\ET\F



**Note:** For the PC cards CIFX 90E-2DP\MR\ET\F, CIFX 90E-2DP\CO\MR\ET\F, CIFX 90E-2DP\DN\MR\ET\F, CIFX 90E-2CO\MR\ET\F, CIFX 90E-2CO\DN\MR\ET\F and CIFX 90E-2DN\MR\ET\F the following is valid:

- (1) The PC cards are equipped with an MRAM (128Kbyte = 64K Words). For further information refer to section *PC Cards cifX with additional MRAM* on page 42.
- (2) The PC cards can be used in an enlarged temperature range from -20 °C to +70 °C.
- (3) The device height and the power input of the PC cards do not comply with the standard specifications.

### 3.3.9 PC Cards PCI-104: CIFX 104C-XX\F and CIFX 104C-XX-R\F

PC Card cifX	Description
<b>PC Cards PCI-104 with AIFX Assembly Interfaces</b>	
<b>Real-Time Ethernet</b>	
CIFX 104C-RE\F	<b>Real-Time Ethernet Master or Slave</b> - Basic card CIFX 104C-RE\F and - Ethernet assembly interface (AIFX-RE).
CIFX 104C-RE-R\F	<b>Real-Time Ethernet Master or Slave</b> (connectors at the left side) - Basic card CIFX 104C-RE-R\F and - Ethernet assembly interface (AIFX-RE).
<b>PROFIBUS</b>	
CIFX 104C-DP\F	<b>PROFIBUS DP Master or Slave or PROFIBUS MPI Device</b> - Basic card CIFX 104C-FB\F and - PROFIBUS assembly interface (AIFX-DP).
CIFX 104C-DP-R\F	<b>PROFIBUS DP Master or Slave or PROFIBUS MPI Device</b> (connectors at the left side) - Basic card CIFX 104C-FB-R\F and - PROFIBUS assembly interface (AIFX-DP).
<b>CANopen</b>	
CIFX 104C-CO\F	<b>CANopen Master or Slave</b> - Basic card CIFX 104C-FB\F and - CANopen assembly interface (AIFX-CO).
CIFX 104C-CO-R\F	<b>CANopen Master or Slave</b> (connectors at the left side) - Basic card CIFX 104C-FB-R\F and - CANopen assembly interface (AIFX-CO).
<b>DeviceNet</b>	
CIFX 104C-DN\F	<b>DeviceNet Master or Slave</b> - Basic card CIFX 104C-FB\F and - DeviceNet assembly interface (AIFX-DN).
CIFX 104C-DN-R\F	<b>DeviceNet Master or Slave</b> (connectors at the left side) - Basic card CIFX 104C-FB-R\F and - DeviceNet assembly interface (AIFX-DN).
<b>CC-Link</b>	
CIFX 104C-CC\F	<b>CC-Link Master or Slave</b> - Basic card CIFX 104C-FB\F and - CC-Link assembly interface (AIFX-CC).

Table 23: PC Cards PCI-104: CIFX 104C-XX\F and CIFX 104C-XX-R\F

### 3.3.10 AIFX Assembly Interfaces

AIFX	Description	For the PC Cards cifX
AIFX-RE	Ethernet Assembly Interface (with Ethernet interface)	CIFX 90-RE\F, CIFX 90E-RE\F, CIFX 90E-RE\ET\F, CIFX 90E-RE\MR\F, CIFX 90E-RE\MR\ET\F, CIFX 104C-RE\F, CIFX 104C-RE-R\F
AIFX-DP	PROFIBUS Assembly Interface (with PROFIBUS interface)	CIFX 90-DP\F, CIFX 90E-DP\F, CIFX 90E-DP\ET\F, CIFX 90E-DP\MR\F, CIFX 90E-DP\MR\ET\F, CIFX 90E-2DP\ET\F, CIFX 90E-2DP\CO\ET\F, CIFX 90E-2DP\DN\ET\F, CIFX 90E-2DP\MR\ET\F, CIFX 90E-2DP\CO\MR\ET\F, CIFX 90E-2DP\DN\MR\ET\F, CIFX 104C-DP\F, CIFX 104C-DP-R\F
AIFX-CO	CANopen Assembly Interface (with CANopen interface)	CIFX 90-CO\F, CIFX 90E-CO\F, CIFX 90E-CO\ET\F, CIFX 90E-CO\MR\F, CIFX 90E-CO\MR\ET\F, CIFX 90E-2CO\ET\F, CIFX 90E-2CO\DN\ET\F, CIFX 90E-2DP\CO\ET\F, CIFX 90E-2CO\MR\ET\F, CIFX 90E-2CO\DN\MR\ET\F, CIFX 90E-2DP\CO\MR\ET\F, CIFX 104C-CO\F, CIFX 104C-CO-R\F
AIFX-DN	DeviceNet Assembly Interface (with DeviceNet interface)	CIFX 90-DN\F, CIFX 90E-DN\F, CIFX 90E-DN\ET\F, CIFX 90E-DN\MR\F, CIFX 90E-DN\MR\ET\F, CIFX 90E-2DN\ET\F, CIFX 90E-2CO\DN\ET\F, CIFX 90E-2DP\DN\ET\F, CIFX 90E-2DN\MR\ET\F, CIFX 90E-2CO\DN\MR\ET\F, CIFX 90E-2DP\DN\MR\ET\F, CIFX 104C-DN\F, CIFX 104C-DN-R\F
AIFX-CC	CC-Link Assembly Interface (with DeviceNet interface)	CIFX 90-CC\F, CIFX 90E-CC\ET\F, CIFX 90E-CC\MR\ET\F, CIFX 104C-CC\F
AIFX-DIAG (optional)	Diagnostic Assembly Interface (with diagnostic interface)	CIFX 104C-RE\F, CIFX 104C-RE-R\F CIFX 104C-DP\F, CIFX 104C-DP-R\F, CIFX 104C-CO\F, CIFX 104C-CO-R\F, CIFX 104C-DN\F, CIFX 104C-DN-R\F, CIFX 104C-CC\F

Table 24: AIFX Assembly Interfaces for PC Cards cifX with Cable Connector



### 3.4 The Function „DMA Mode“

Device revisions which provide **DMA Mode** are listed separately in section *Hardware: PC Cards cifX, AIFX Assembly Interfaces* on page 10.

The **DMA Mode** is activated via the device driver **cifX Device Driver**.



For further information refer to the user manual **Software Installation for the PC Cards cifX** in section *Activating DMA Mode in the cifX Device Driver Setup*.

#### Requirements

For device revisions providing the **DMA Mode** the required versions of the firmware, the driver and the SYCON.net setup must be used:

PC Card cifX	From Hardw. Rev.	Firmware File	Protocol	From Firmware Version
CIFX 80-RE,	1	CIFXECM.NXF	EtherCAT Master	2.4.6.0
CIFX 90-RE\F,	1	CIFXECS.NXF	EtherCAT Slave	2.5.5.0
CIFX 90E-RE\F,	A	CIFXEIM.NXF	EtherNet/IP Scanner	2.2.x.x
CIFX 90E-RE\ET\F	1	CIFXEIS.NXF	EtherNet/IP Adapter	2.3.x.x
CIFX 90E-RE\MR\F	1	CIFXOMB.NXF	Open Modbus/TCP	2.4.x.x
CIFX 90E-RE\MR\ET\F	1	CIFXPLS.NXF	POWERLINK Controlled Node	2.1.24.0
CIFX 104C-RE,	1	CIFXPNS.NXF	PROFINET IO Controller	2.3.x.x
CIFX 104C-RE-R,	1	CIFXPNS.NXF	PROFINET IO Device	3.4.x.x (V3)
CIFX 104C-RE\F,	1	CIFXS3M.NXF	sercos Master	2.0.15.0
CIFX 104C-RE-R\F	1	CIFXS3S.NXF	sercos Slave	3.0.15.0
		CIFXVRS.NXF	VARAN Client	1.0.x.x
CIFX 80-DP,	1	CIFXDPM.NXF	PROFIBUS DP Master	2.3.x.x
CIFX 90-DP\F,	1	CIFXDPS.NXF	PROFIBUS DP Slave	2.3.x.x
CIFX 90E-DP\F,	5	CIFXMPI.NXF	PROFIBUS MPI Device	<i>not supported</i>
CIFX 90E-DP\ET\F	1			
CIFX 90E-DP\MR\F	1			
CIFX 90E-DP\MR\ET\F	1			
CIFX 90E-2DP\ET\F	1			
CIFX 90E-2DP\MR\ET\F	1			
CIFX 104C-DP,	1			
CIFX 104C-DP-R,	1			
CIFX 104C-DP\F,	1			
CIFX 104C-DP-R\F	1			
CIFX 80-CO,	1	CIFXCOM.NXF	CANopen Master	2.3.x.x
CIFX 90-CO\F,	1	CIFXCOS.NXF	CANopen Slave	2.3.x.x
CIFX 90E-CO\F,	4			
CIFX 90E-CO\ET\F	1			
CIFX 90E-CO\MR\F	1			
CIFX 90E-CO\MR\ET\F	1			
CIFX 104C-CO,	1			
CIFX 104C-CO-R,	1			
CIFX 104C-CO\F,	1			
CIFX 104C-CO-R\F	1			
CIFX 80-DN,	1	CIFXDNM.NXF	DeviceNet Master	2.2.x.x
CIFX 90-DN\F,	1	CIFXDNS.NXF	DeviceNet Slave	2.2.x.x
CIFX 90E-DN\F,	4			
CIFX 90E-DN\ET\F	1			
CIFX 90E-DN\MR\F	1			
CIFX 90E-DN\MR\ET\F	1			
CIFX 104C-DN,	1			
CIFX 104C-DN-R,	1			
CIFX 104C-DN\F,	1			
CIFX 104C-DN-R\F	1			
CIFX 90-CC\F	1	CIFXCPS.NXF	CC-Link Slave	2.4.x.x
CIFX 90E-CC\ET\F	1			
CIFX 90E-CC\MR\ET\F	1			
CIFX 104C-CC\F	1			

Table 25: Firmware Versions for the DMA Mode

PC Cards PCI and PCI Express with two Channels:

PC Card cifX	From Hardw. Rev.	Firmware File	Protocol	From Firmware Version
CIFX 90E-2DP\ET\F CIFX 90E-2DP\MR\ET\F	1	CIFX2DPM.NXF	PROFIBUS DP Master, 2 Kanäle	1.0.x.x (new version counting)
		CIFX2DPS.NXF	PROFIBUS DP Slave, 2 Kanäle	1.0.x.x (new version counting)
CIFX 90E-2DP\CO\ET\F CIFX 90E-2DP\CO\MR\ET\F	1	C0201040.NXF	PROFIBUS DP Master, 1 Channel + CANopen Master, 1 Channel	1.0.x.x
		C0202050.NXF	PROFIBUS DP Slave, 1 Channel + CANopen Slave, 1 Channel	1.0.x.x
CIFX 90E-2DP\DN\ET\F CIFX 90E-2DP\DN\MR\ET\F	1	C0201060.NXF	PROFIBUS DP Master, 1 Channel + DeviceNet Master, 1 Channel	1.0.x.x
		C0202070.NXF	PROFIBUS DP Slave, 1 Channel + DeviceNetSlave, 1 Channel	1.0.x.x
CIFX 90E-2CO\ET\F CIFX 90E-2CO\MR\ET\F	1	C0204040.NXF	CANopen Master, 2 Channels	1.0.x.x
		C0204050.NXF	CANopen Master, 1 Channel + CANopen Slave, 1 Channel	1.0.x.x
		C0205050.NXF	CANopen Slave, 2 Channels	1.0.x.x
CIFX 90E-2CO\DN\ET\F CIFX 90E-2CO\DN\MR\ET\F	1	C0204060.NXF	CANopen Master, 1 Channel + DeviceNet Master, 1 Channel	1.0.x.x
		C0205070.NXF	CANopen Slave, 1 Channel + DeviceNet Slave, 1 Channel	1.0.x.x
CIFX 90E-2DN\ET\F CIFX 90E-2DN\MR\ET\F	1	C0206060.NXF	DeviceNet Master, 2 Channels	1.0.x.x
		C0207070.NXF	DeviceNet Slave, 2 Channels	1.0.x.x

Table 26: Firmware Versions for the DMA Mode (for 2 Channel Systems)

Driver and Software	Version or higher
cifX Device Driver	0.95x
SYCON.net	V1.201.x.x

Table 27: Versions Driver and SYCON.net for the DMA Mode

### 3.5 PC Cards cifX with additional MRAM

The PC cards CIFX 90E-XX\MR\F (CIFX 90E-RE\MR\F, CIFX 90E-DP\MR\F, CIFX 90E-CO\MR\F, CIFX 90E-DN\MR\F) or CIFX 90E-XX\MR\ET\F (CIFX 90E-RE\MR\ET\F, CIFX 90E-DP\MR\ET\F, CIFX 90E-CO\MR\ET\F, CIFX 90E-DN\MR\ET\F, CIFX 90E-CC\MR\ET\F) are identical to the PC cards CIFX 90E-XX and work with the same firmware. However, the PC cards CIFX 90E-XX\MR or CIFX 90E-XX\MR\ET\F have an additional memory module for storing remanent data, MRAM with 128Kbyte (= 64K words). Using the cifX Device Driver (from Version 1.1.1.0) access from the application program to this memory is possible and it can be used as a remanent memory for the host system.

The 2 channel PC cards CIFX 90E-2XX\MR\ET\F (CIFX 90E-2DP\MR\ET\F, CIFX 90E-2CO\MR\ET\F, CIFX 90E-2DN\MR\ET\F) and CIFX 90E-2XX\XX\MR\ET\F (CIFX 90E-2DP\CO\MR\ET\F, CIFX 90E-2DP\DN\MR\ET\F, CIFX 90E-2CO\DN\MR\ET\F) also provide the MRAM module with 128Kbyte (= 64K words).

### 3.6 System Requirements

#### 3.6.1 Slot for the PC Cards cifX Compact PCI, Mini PCI, Mini PCIe, PCI-104

PC with slot (3.3 V) for PC cards cifX *Compact PCI, Mini PCI, Mini PCI Express* and *PCI-104*:

PC Cards cifX		PCI Bus [Pins]	Slot
CIFX 80-RE CIFX 80-DP CIFX 80-CO CIFX 80-DN		110	<b>Compact PCI Slot</b> (3.3 V)
CIFX 90-RE\F CIFX 90-DP\F CIFX 90-CO\F CIFX 90-DN\F CIFX 90-CC\F		124	<b>Mini PCI Socket</b> (3.3 V), Type III System Connector
CIFX 90E-RE\F      CIFX 90E-2DP\ET\F CIFX 90E-DP\F      CIFX 90E-2DP\CO\ET\F CIFX 90E-CO\F      CIFX 90E-2DP\DN\ET\F CIFX 90E-DN\F      CIFX 90E-2CO\ET\F CIFX 90E-RE\MR\F      CIFX 90E-2CO\DN\ET\F CIFX 90E-DP\MR\F      CIFX 90E-2DN\ET\F CIFX 90E-CO\MR\F      CIFX 90E-2DP\MR\ET\F CIFX 90E-DN\MR\F      CIFX 90E-2DP\COMR\ET\F CIFX 90E-RE\ET\F      CIFX 90E-2DP\DN\MR\ET\F CIFX 90E-DP\ET\F      CIFX 90E-2CO\MR\ET\F CIFX 90E-CO\ET\F      CIFX 90E-2CO\DN\MR\ET\F CIFX 90E-DN\ET\F      CIFX 90E-2DN\MR\ET\F CIFX 90E-CC\ET\F CIFX 90E-RE\MR\ET\F CIFX 90E-DP\MR\ET\F CIFX 90E-CO\MR\ET\F CIFX 90E-DN\MR\ET\F CIFX 90E-CC\MR\ET\F		52	<b>PCI Express Mini System Connector</b> (3.3 V), X1/X2 <sup>2</sup> = One Lane   <b>Note:</b> As the basic cards CIFX 90E (all variants 'MR' or 'ET'), CIFX 90E-2FB\ET or CIFX 90E-2FB\MR\ET can be inserted correctly into the Mini PCI Express slot, the element height in the Mini PCI Express slot of the connecting device must meet to the standard specifications.
CIFX 104C-RE      CIFX 104C-CO CIFX 104C-RE-R      CIFX 104C-CO-R CIFX 104C-RE\F      CIFX 104C-CO\F CIFX 104C-RE-R\F      CIFX 104C-CO-R\F CIFX 104C-DP      CIFX 104C-DN CIFX 104C-DP-R      CIFX 104C-DN-R CIFX 104C-DP\F      CIFX 104C-DN\F CIFX 104C-DP-R\F      CIFX 104C-DN-R\F CIFX 104C-CC\F		120	<b>PCI-104 Slot</b>  (Supply Voltage 5 V or 3.3 V, Signaling Voltage 5 V or 3.3 V)

Table 28: Slot for the PC Cards cifX *Compact PCI, Mini PCI, Mini PCIe, Mini PCIe (2 channel), PCI-104*

<sup>2</sup> X1, X2 corresponds to the Hilscher convention for „interface“ on the top or the bottom side of the PC Card cifX.

### 3.6.2 Notes on the Card Height - PC Card cifX Mini PCI and Mini PCIe

PC Cards cifX	Dimensions (L x B x D)	Note
CIFX 90-RE\F CIFX 90-DP\F CIFX 90-CO\F CIFX 90-DN\F CIFX 90-CC\F	<b>60,0 x 45 x 9,5 mm</b>	The element heights <u>on top</u> of the PC cards CIFX 90-RE\F, CIFX 90-DP\F, CIFX 90-CO\F, CIFX 90-DN\F or CIFX 90-CC\F <b>Mini PCI</b> do not meet the standard specifications.
CIFX 90E-RE\F CIFX 90E-DP\F CIFX 90E-CO\F CIFX 90E-DN\F CIFX 90E-RE\MR\F CIFX 90E-DP\MR\F CIFX 90E-CO\MR\F CIFX 90E-DN\MR\F CIFX 90E-RE\ET\F CIFX 90E-DP\ET\F CIFX 90E-CO\ET\F CIFX 90E-DN\ET\F CIFX 90E-CC\ET\F CIFX 90E-RE\MR\ET\F CIFX 90E-DP\MR\ET\F CIFX 90E-CO\MR\ET\F CIFX 90E-DN\MR\ET\F CIFX 90E-CC\MR\ET\F CIFX 90E-2DP\ET\F CIFX 90E-2DP\CO\ET\F CIFX 90E-2DP\DN\ET\F CIFX 90E-2CO\ET\F CIFX 90E-2CO\DN\ET\F CIFX 90E-2DN\ET\F CIFX 90E-2DP\MR\ET\F CIFX 90E-2DP\CO\MR\ET\F CIFX 90E-2DP\DN\MR\ET\F CIFX 90E-2CO\MR\ET\F CIFX 90E-2CO\DN\MR\ET\F CIFX 90E-2DN\MR\ET\F	<p>CIFX 90E-XX\F (from hardware revision A): CIFX 90E-XX\MR\F (from hardware revision B): <b>51 x (30,2 +/- 0,1) x 11 mm</b></p> <p>CIFX 90E-XX\ET\F*, CIFX 90E-XX\MR\ET\F*, CIFX 90E-2XX\ET\F*, CIFX 90E-2XX\XX\ET\F*, CIFX 90E-2XX\MR\ET\F*, CIFX 90E-2XX\XX\MR\ET\F* (*from hardware revision 1): <b>51 x (30,2 +/- 0,1) x 12,5 mm</b></p> <p>CIFX 90E-XX\F, CIFX 90E-XX\MR\F CIFX 90E-XX\ET\F, CIFX 90E-XX\MR\ET\F CIFX 90E-2XX\ET\F CIFX 90E-2XX\XX\ET\F CIFX 90E-2XX\MR\ET\F CIFX 90E-2XX\XX\MR\ET\F</p> <p>Toleranz</p> <p>netX 100 +6,4 +7,8 +/- 0,2 Cooling Element</p> <p>Element height +1,83 +1,83 +/- 0,18 topside</p> <p>Height of the +1,0 +1,0 +/- 0,1 printed circuit</p> <p>Element height +1,3 +1,3 +/- 0,1 bottom side</p> <p>Max. total height (D) = ~ 11 = ~ 12,5 of the PC card cifX mm mm in milli meters</p>	<p>The element heights <u>on top</u> of the PC card CIFX 90E-XX\F <b>Mini PCI Express</b> (all variants and 2 channel formats)<sup>3</sup> do not meet the standard specifications.</p> <p><b>Note:</b> The element height <u>at the bottom side</u> of the PC card CIFX 90E-XX\F (all variants and 2 channel formats) is in accordance with the standard specifications. As the PC card CIFX 90E-XX\F (all variants and 2 channel formats) can be inserted correctly into the Mini PCI Express slot of the connecting device must meet to the standard specifications.</p> <p><b>Note:</b> The element heights of the cable connectors ‚Ethernet (X4)‘ or ‚Fieldbus (X3)‘ are appr. 8,5 mm over PCB each, including the cable.</p>

Table 29: Notes on the Card Height - PC Card cifX Mini PCI and Mini PCI Express

<sup>3</sup> Variants of the PC card CIFX 90E-XX\F: CIFX 90E-XX\ET\F, CIFX 90E-XX\MR\F or CIFX 90E-XX\MR\ET\F (XX = RE, DP, CO or DN) ;  
2 Channel format: CIFX 90E-2XX\ET\F, CIFX 90E-2XX\XX\ET\F,  
CIFX 90E-2XX\MR\ET\F, CIFX 90E-2XX\XX\MR\ET\F

### 3.6.3 Panel Cutout for Installing AIFX

In order to connect the AIFX assembly interface to a PC card cifX **Mini PCI** and **Mini PCI Express** with cable connector Ethernet or fieldbus (labeling „\F“), make sure that **the housing panel of the PC or of the connecting device** has an appropriate cutout and holes for fastening the AIFX.

In order to connect the AIFX assembly interface to a PC card cifX **PCI-104** with cable connector Ethernet or fieldbus (labeling „\F“), make sure that **the front plate of the PC cabinet** has an appropriate cutout and holes for fastening the AIFX.

PC Cards cifX	Panel Cutout
Mini PCI; Mini PCI Express	at the housing panel of the PC
PCI-104	at the front plate of the PC cabinet

Table 30: Panel Cutout at the at the Housing Panel of the PC or at the front plate of the PC cabinet

The panel cutout must be dimensioned sufficiently large for the interface, display or control elements placed on the AIFX. Partial standard cutouts can be used.

PC Cards cifX	AIFX	Panel Cutout and Holes	
CIFX 90-RE\F CIFX 90E-RE\F CIFX 90E-RE\ET\F CIFX 90E-RE\MR\F CIFX 90E-RE\MR\ET\F CIFX 104C-RE\F CIFX 104C-RE-R\F	AIFX-RE	Required Cutout	for two RJ45 Sockets <b>Important!</b> The panel cutout layout must also cover the LEDs COM 0 and COM1 at the AIFX-RE.
		Standard cutout	D-Sub-15
		Holes	2, distance between the holes 37,3 mm
		Further Information	In the data sheet <i>MOD JACK – MJIM</i> [2], as well as in section as in section <i>Ethernet - AIFX-RE</i> on page 72.
CIFX 90-DP\F CIFX 90E-DP\F CIFX 90E-DP\ET\F CIFX 90E-DP\MR\F CIFX 90E-DP\MR\ET\F CIFX 90E-2DP\ET\F CIFX 90E-2DP\MR\ET\F CIFX 90E-2DP\CO\ET\F CIFX 90E-2DP\COMR\ET\F CIFX 90E-2DP\DN\ET\F CIFX 90E-2DP\DNMR\ET\F CIFX 104C-DP\F CIFX 104C-DP-R\F	AIFX-DP	Required Cutout	for Dsub female Connector, 9 pin
		Standard cutout	D-Sub-9
		Holes	2, distance between the holes 25 mm
		Further Information	in section <i>PROFIBUS - AIFX-DP</i> on page 73.
CIFX 80-CO CIFX 90-CO\F CIFX 90E-CO\F CIFX 90E-CO\ET\F CIFX 90E-CO\MR\F CIFX 90E-CO\MR\ET\F CIFX 90E-2CO\ET\F CIFX 90E-2CO\MR\ET\F CIFX 90E-2DP\CO\ET\F CIFX 90E-2DP\COMR\ET\F CIFX 90E-2CO\DN\ET\F CIFX 90E-2CO\DNMR\ET\F CIFX 104C-CO\F CIFX 104C-CO-R\F	AIFX-CO	Required Cutout	for D-Sub male Connector, 9 pin
		Standard cutout	D-Sub-9
		Holes	2, distance between the holes 25 mm
		Further Information	in section <i>CANopen - AIFX-CO</i> on page 74.

PC Cards cifX	AIFX	Panel Cutout and Holes	
CIFX 90-DN\F CIFX 90E-DN\F CIFX 90E-DN\ET\F CIFX 90E-DN\MR\F CIFX 90E-DN\MR\ET\F CIFX 90E-2DN\ET\F CIFX 90E-2DN\MR\ET\F CIFX 90E-2DP\DN\ET\F CIFX 90E-2DP\DN\MR\ET\F CIFX 90E-2CO\DN\ET\F CIFX 90E-2CO\DN\MR\ET\F CIFX 104C-DN\F CIFX 104C-DN-R\F	AIFX-DN	Required Cutout	for CombiCon male Connector, 5 pin
		Standard cutout	CombiCon male Connector
		Holes	2x2, distance between the holes 24,94 mm
		Further Information	in section <i>DeviceNet - AIFX-DN</i> on page 75.
CIFX 90-CC\F CIFX 90E-CC\ET\F CIFX 90E-CC\MR\ET\F CIFX 104C-CC\F	AIFX-CC	Required Cutout	for CombiCon male Connector, 5 pin
		Standard cutout	CombiCon male Connector
		Holes	2x2, distance between the holes 24,96 mm
		Further Information	in section <i>CC-Link - AIFX-CC</i> on page 76.
CIFX 104C-RE\F CIFX 104C-RE-R\F CIFX 104C-DP\F CIFX 104C-DP-R\F CIFX 104C-CO\F CIFX 104C-CO-R\F CIFX 104C-DN\F CIFX 104C-DN-R\F	AIFX-DIAG	Required Cutout	for the light channels, the rotary switches and the Mini B USB plug
		Standard cutout	-
		Holes	2, distance between the holes 47,1 mm
		Further Information	in section <i>Diagnostic - AIFX-DIAG</i> on page 77.

Table 31: Required Panel Cutout and Holes for AIFX

### 3.6.4 Operating Temperature Range for UL Certificate

The UL certificate for the PC cards cifX is valid for the ranges 0°C to +55°C or 0°C bis +70°C depending by the device as indicated in section *Technical Data PC Cards cifX* on page 139.

Regardless of this the PC cards cifX are designed for the operating temperatures (-20°C to +55°C or -20°C to +70°C) as specified in section *Technical Data PC Cards cifX* on page 139.

### 3.6.5 Power Supply and Host Interface

For the power supply and the host interface used for the PC cards cifX *Compact PCI, Mini PCI, Mini PCI Express* and *PCI-104* you must observe the following requirements:

PC Cards cifX	Supply Voltage	Signaling Voltage Host Interface	Host Interface (PCI slot)
CIFX 80-RE CIFX 80-DP CIFX 80-CO CIFX 80-DN CIFX 90-CC\F	+3.3 V dc ±5 %/ Max. 1 A	5 V or 3.3 V	Compact PCI
CIFX 90-RE\F CIFX 90-DP\F CIFX 90-CO\F CIFX 90-DN\F	+3.3 V dc ±5 %/ Max 1 A <i>Note:</i> The power input of the CIFX 90-XX\F does not comply with the standard specifications.	3.3 V  (5 V only if 5 V are connected via pin 28. Refer also to section <i>Pin Assignment for Mini PCI Bus, X1</i> , page 133)	Mini PCI

PC Cards cifX		Supply Voltage	Signaling Voltage Host Interface	Host Interface (PCI slot)
CIFX 90E-RE\F CIFX 90E-DP\F CIFX 90E-CO\F CIFX 90E-DN\F CIFX 90E-RE\MR\F CIFX 90E-DP\MR\F CIFX 90E-CO\MR\F CIFX 90E-DN\MR\F CIFX 90E-RE\ET\F CIFX 90E-DP\ET\F CIFX 90E-CO\ET\F CIFX 90E-DN\ET\F CIFX 90E-CC\ET\F CIFX 90E-RE\MR\ET\F CIFX 90E-DP\MR\ET\F CIFX 90E-CO\MR\ET\F CIFX 90E-DN\MR\ET\F CIFX 90E-CC\MR\ET\F	CIFX 90E-2DP\ET\F CIFX 90E-2DP\CO\ET\F CIFX 90E-2DP\DN\ET\F CIFX 90E-2CO\ET\F CIFX 90E-2CO\DN\ET\F CIFX 90E-2DN\ET\F CIFX 90E-2DP\MR\ET\F CIFX 90E-2DP\CO\MR\ET\F CIFX 90E-2DP\DN\MR\ET\F CIFX 90E-2CO\MR\ET\F CIFX 90E-2CO\DN\MR\ET\F CIFX 90E-2DN\MR\ET\F	+3.3 V dc $\pm 5\%$ / Max. 1 A  <i>Note:</i> The power input of the CIFX 90E-XX\F (all variants) <sup>4</sup> does not comply with the standard specifications.	PCIe compatible	Mini PCI Express
CIFX 104C-RE CIFX 104C-RE-R CIFX 104C-RE\F CIFX 104C-RE-R\F CIFX 104C-DP CIFX 104C-DP-R CIFX 104C-DP\F CIFX 104C-DP-R\F	CIFX 104C-CO CIFX 104C-CO-R CIFX 104C-CO\F CIFX 104C-CO-R\F CIFX 104C-DN CIFX 104C-DN-R CIFX 104C-DN\F CIFX 104C-DN-R\F CIFX 104C-CC\F	+5 V dc $\pm 5\%$ / Max. 750 mA or +3.3 V dc $\pm 5\%$ / Max. 1 A	5 V or 3.3 V	PCI-104

Table 32: Requirements Power Supply and Host Interface for PC Cards cifX Compact PCI, Mini PCI, Mini PCI Express and PCI-104

The data in the Table 32 have the following meaning:

**Supply Voltage**

The required and permissible supply voltage at the PC cards cifX *Compact PCI*, *Mini PCI*, *Mini PCI Express* and *PCI-104*.



**Note:** To ensure that the compatibility between different systems is guaranteed, providing a maximum of 1 A (for +3.3 VDC  $\pm 5\%$ ) or 750 mA (for +5 VDC  $\pm 5\%$ ) is recommended.

The typical current depends on the type of the PC card cifX. For detailed values on the typical current see section *Technical Data PC Cards cifX* on page 139.

**Signaling Voltage Host Interface**

- The required or tolerated signaling voltage at the I/O signal pins
- at the Compact PCI bus of the PC cards cifX *Compact PCI*,
  - at the Mini PCI bus of the PC cards cifX *Mini PCI*,
  - at the Mini PCI Express bus of the PC cards cifX *Mini PCI Express*
  - as well as at the PCI-104 bus of the PC cards cifX *PCI-104*.

**Host Interface (PCI slot)** Type of the host interface

<sup>4</sup> Variants of the PC card CIFX 90E-XX\F: CIFX 90E-XX\ET\F, CIFX 90E-XX\MR\F or CIFX 90E-XX\MR\ET\F (XX = RE, DP, CO or DN)

### 3.7 Requirements for Operation of the PC Cards cifX

Operating the PC cards cifX properly, the following described requirements must be fulfilled.





<b>Protocols</b>	EtherCAT Slave, EtherCAT Master, EtherNet/IP Adapter (Slave), EtherNet/IP Scanner (Master), Open Modbus/TCP, POWERLINK-Controlled-Node/Slave, PROFINET IO Device (Slave), PROFINET IO Controller (Master),	sercos Slave, sercos Master, VARAN Client (Slave)	PROFIBUS DP Slave, PROFIBUS DP Master, PROFIBUS MPI Device, CANopen Slave, CANopen Master, DeviceNet Slave, DeviceNet Master, CC-Link Slave
<b>Software Installation</b>	<p>1. Driver for the Host Interface Host Interfaces: Compact PCI, Mini PCI, Mini PCI Express and PCI-104</p> <ul style="list-style-type: none"> <li>The device driver <b>cifX Device Driver</b> must be installed (from V1.0.x.x).</li> </ul> <p>If you install the device into a PC, in general Windows® will be available as operating system. In this case the cifX Device Driver must be installed to communicate to the device and to exchange data via the dual-port memory.</p> <p> <b>Important!</b> Upgrade older versions of the <b>cifX Device Driver</b> necessarily on the current version indicated in section <i>Driver and Software</i> on page 13.</p> <p>OR</p> <ul style="list-style-type: none"> <li>If Windows® is not available as operating system, an own driver must be developed using the cifX Driver Toolkit and this driver must be installed.</li> <li>For the operating systems Linux, Windows® CE, VxWorks, QNX and IntervalZero RTX™ you can buy Device Driver at the company Hilscher Gesellschaft für Systemautomation mbH <a href="http://www.hilscher.com/">http://www.hilscher.com/</a>.</li> </ul> <p>2. The configuration software <b>SYCON.net</b> or alternatively the simple Slave configuration tool <b>netX Configuration Tool</b> must be installed or another application program by which the PC card cifX (Slave) can be parameterized.</p>		
<b>How to use the Software</b>	<p>On how to use the software for the configuration, the firmware download and for the diagnosis, note the following notice:</p> <p> <b>Important!</b> The <u>USB interface</u>, the <u>serial interface</u> as well as the <u>cifX Device Driver</u> may only be used exclusively by <b>one</b> software, that is</p> <ul style="list-style-type: none"> <li>- the <b>SYCON.net</b> configuration software (with integrated ODMV3) or</li> <li>- the <b>netX Configuration Tool</b> or</li> <li>- the <b>cifX Test Application</b> or</li> <li>- the <b>cifX Driver Setup Utility</b> or</li> <li>- the application program.</li> </ul> <p>Never use the listed software simultaneously, otherwise this will result in communication problems with the device.</p> <p>If the SYCON.net configuration software was used on the PC, then stop the ODMV3 service before you use one of the other software listed above. Therefore, select <b>Service &gt; Stop</b> from the context menu of the ODMV3 system tray icon.</p>		
<b>Firmware Download</b>	<p>3. Using the configuration software <b>SYCON.net</b> or for the Slave alternatively the Slave configuration tool <b>netX Configuration Tool</b>, the user must select and download the firmware to the PC card cifX.</p>		
<b>Parameter Setting</b>	<p>4. The PC card cifX must be parameterized using one of the following options:</p> <ul style="list-style-type: none"> <li>• Configuration Software <b>SYCON.net</b></li> <li>• alternatively Slave configuration tool <b>netX Configuration Tool</b> (only Slave)</li> <li>• Application program (programming required)</li> </ul>		
<b>Communication</b>	<p>5. For the communication of a PC card cifX (Slave) a Master device for the respective communication system is required. For the communication of a PC card cifX (Master) a Slave device for the respective communication system is required.</p>		
<b>PC Settings for PC Cards cifX PCI Express</b>	<p> <b>Important!</b> If you install a PC card cifX PCI Express, you <u>always</u> must disable the Microsoft Windows "Link State Power Management". Otherwise, it cannot be excluded that your PC freezes during the PC card cifX PCI Express is in operation.</p>		
<b>Hardware Installation</b>	<p> <b>Important!</b> Operating the PC cards cifX with <b>Cable Connector Ethernet</b> or with the <b>Cable Connector Fieldbus</b> (label "VF" in its device name) requires proper connection of the Ethernet (AIFX-RE), PROFIBUS (AIFX-DP), CANopen (AIFX-CO), DeviceNet (AIFX-DN) or CC-Link (AIFX-CC) assembly interface to the basic card! For 2-channel devices both assembly interfaces must be connected.</p>		
<b>Environmental Conditions</b>	<p>Due to a plug element from ERNI the lower limit of the operating temperature for all PC cards cifX Real-Time Ethernet is 0 °C. This applies to all hardware revisions of the PC card cifX Real-Time Ethernet.</p>		

Table 33: Requirements to operate PC Cards cifX properly



## 3.8 Prerequisites for Certification

### 3.8.1 PROFINET IO Certification for IRT and SYNC0 Signal

#### 3.8.1.1 Providing SYNC0 Signal at SYNC Connector of the PC Card cifX



---

**Note:** A PROFINET IO certification for PROFINET IRT requires (mandatory) that your PC card cifX offers the synchronization signal (SYNC0), in order to allow e. g. connecting an oscilloscope. Therefore the SYNC connector of your PC card cifX must be accessible.

---

Information about where the SYNC connector is placed on your PC card cifX, you can find in the chapter *Device Drawings* on page 58.

#### 3.8.1.2 Using the SYNC0 Signal at the Host System

*Only valid for  
PC Cards Mini PCI Express CIFX 90E-XXMRIF or  
PC Cards Mini PCI Express CIFX 90E-XXMRIETF*

If you forward the SYNC0 signal of your PC card cifX Mini PCI Express to the Mini PCI Express bus X2, you must adhere to the following design specification:



---

**Note:** A PROFINET IO certification for PROFINET IRT requires (mandatory) that the host system offers a connector for the synchronization signal (SYNC0), in order to allow e. g. connecting an oscilloscope.

---

For this purpose you must use the SYNC0 signal and mass of the Mini PCI Express bus X2 of the PC card cifX Mini PCI Express at the host system and provide it at the host system via a well accessible 2-pin connector.

The PC card cifX Mini PCI Express provides the SYNC0 signal *SYNC0*. The SYNC0 signal is provided at pin 46 of the Mini PCI Express bus X2. For the pin assignment of the Mini PCI Express bus X2, refer to section *Pin Assignment for Mini PCI Express Bus / SYNC Connector (Bootstart), X1/X2* on page 135.

The SYNC0 signal has LVTTTL level (3.3 V). A maximum load of 6 mA must not be exceeded.



You should keep the cable length for the sync signals below 50 mm and take into account EMC aspects.





## 4 Getting Started

### 4.1 Installation and Configuration PC Card cifX

The following table describes the steps for the software and hardware installation and for the configuration of a PC card cifX Compact PCI, Mini PCI, Mini PCI Express and PCI-104 (Master and Slave) Real-Time Ethernet and fieldbus as it is typical for many cases. The Slave device can be configured using the corresponding Slave DTM in the configuration software **SYCON.net**. Alternatively, you can also use the simple Slave configuration tool **netX Configuration Tool**. The Master device can be configured using the corresponding Master DTM in the configuration software **SYCON.net**.

#	Step	Description	For detailed information see manual / section	Page
<b>1</b>	<b>Installing Driver and Software</b>			
1.1	Installing <b>cifX Device Driver</b>	Enter the Communication Solutions DVD in the PC and follow to the instructions of the installation wizard, to install the driver.	<i>Refer to User Manual Software Installation for the PC Cards cifX</i>	
1.2	<b>Installing USB Driver</b> Depending by device type / features	<u>Only for PC Cards cifX Compact PCI, PCI-104 equipped with an USB interface or with the diagnostic assembly interface (AIFX-DIAG)</u>		
1.3	Installing SYCON.net	<u>For PC Cards cifX Master or Slave:</u> Run the SYCON.net-Setup and follow to the instructions of the installation wizard.		
1.4	Installing <b>netX Configuration Tool</b>	<u>For PC Cards cifX Slave:</u> Start the <b>netX Configuration Tool setup</b> program to install the <b>netX Configuration Tool</b> .		
<b>2</b>	<b>Preparing Hardware Installation</b>			
2.1	Take precautions on Electrostatically sensitive Devices	<div style="background-color: #0056b3; color: white; padding: 2px; display: inline-block;"><b>NOTICE</b></div> <b>Electrostatically sensitive Devices</b> Make sure, that the PC card cifX is grounded via the endplate and the PC and make sure, that you are discharged when you install/ uninstall the PC Card cifX.	<i>Electrostatically sensitive Devices</i>	28
2.2	Glue sticker on the front plate.	<u>For CIFX 80-RE</u>	<i>Fix Front Plate Sticker at CIFX 80-RE</i>	81
2.3	<b>Set PCI-104 Slot Number.</b>	<u>For PC Cards cifX PCI-104:</u> Set physical <b>PCI-104 Slot Number</b> .	<i>Rotary Switch for PCI-104 Slot Number</i>	127
<b>3</b>	<b>Hardware Installation</b>	Installing cifX. Take required safety precautions.	<i>Hardware Installation and Uninstalling</i>	78
3.1	Take safety precautions	<div style="background-color: #ff9900; color: white; padding: 2px; display: inline-block;"><b>WARNING</b></div> <b>Lethal Electrical Shock caused by parts with more than 50V!</b> Disconnect the power plug of the PC or of the connecting device. Make sure, that the power supply is off at the PC or at the connecting device.	<i>Electrical Shock Hazard</i>	26
3.2	Open cabinet	Now open the cabinet of the PC or of the connecting device.	<i>Installing PC Cards cifX Compact PCI,</i>	82,

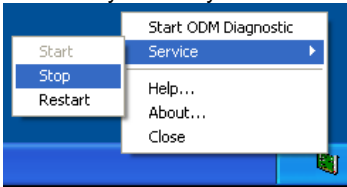
#	Step	Description	For detailed information see manual / section	Page
3.3	Installing cifX	Plug in and mount the PC card cifX.	<i>Installing PC Cards cifX Mini PCI and Mini PCI Express</i>	84
3.4	If so, plug module	For PC Cards cifX PCI-104: (a) Install the first PCI-104 module on the mainboard. (b) Install any other PCI-104 module on the respective underlying PCI-104 module.	<i>Installing PC Cards cifX PCI-104</i>	89
3.5	Connect AIFX (only for PC Cards cifX Mini PCI, Mini PCI Express and PCI-104 with label "F" in its device name and with Cable Connector Ethernet X4 or Fieldbus X3)	 <b>Important!</b> Operating the PC cards cifX with AIFX assembly interface requires proper connection of the AIFX-RE, AIFX-DP, AIFX-CO, AIFX-DN or AIFX-CC assembly interface to the basic card! For 2-channel devices both assembly interfaces must be connected. Note for PC cards cifX with 2 channels, which assembly interface must be connected to the cabel connector fieldbus X3 or X4. <hr/> If so, connect an Ethernet (AIFX-RE), PROFIBUS (AIFX-DP), CANopen (AIFX-CO), DeviceNet (AIFX-DN) or CC-Link (AIFX-CC) assembly interface. If so, additionally connect a diagnostic assembly interface (AIFX-DIAG). <hr/> To the basic card of each PC card cifX first connect the AIFX-RE, AIFX-DP, AIFX-CO, AIFX-DN, AIFX-CC or AIFX-DIAG assembly interface to the PC card cifX and check if the connector is plugged in correctly. For PC cards PCI-104: Only then plug another PCI-104 module.	<i>The Label „F“ in the Device Name</i>  <i>Table 38: How to assign the Assembly Interfaces for 2-Channel Cards cifX Mini PCI Express</i>	32  86
3.6	Close cabinet	Close the cabinet of the PC or connecting device.		
3.7	Plug the connecting cable to the Master or Slave	<u>Note for all PC Cards cifX Real-Time Ethernet:</u>  <b>Note!</b> The RJ45 socket is only for use in LAN, not for telecommunication circuits. <hr/> <u>Note for PC Cards cifX PROFINET IO Controller:</u>  <b>Important for Hardware Wiring!</b> Connect only ports with each other, which have different cross-over settings. Otherwise a connection between the devices can not be established. If the port settings of the PC card cifX PROFINET IO controller are not set to AUTO, then Port0 is switched uncrossed and Port1 crossed. <hr/> Plug in the connecting cable from the PC card cifX to the PC card Master or Slave.	<i>Ethernet Interface</i>  <i>See corresponding user manual</i>	123
3.8	Connect the PC to the power / switch on.	Connect the PC or the connecting device to the power supply and switch it on.		

#	Step	Description	For detailed information see manual / section	Page		
<b>4</b>	<b>Hardware Settings</b>	Hardware Settings in the Driver Setup				
4.1	<b>DMA Mode</b> in the cifX Device Driver Setup	Activate the <b>DMA Mode</b> in the cifX Device Driver Setup.	<i>Refer to User Manual Software Installation for the PC Cards cifX</i>			
<b>5</b>	<b>PC Settings</b>					
5.1	for PC Cards cifX PCI Express	 <b>Important!</b> If you install a PC card cifX PCI Express, you <u>always</u> must disable the Microsoft Windows "Link State Power Management". Otherwise, it cannot be excluded that your PC freezes during the PC card cifX PCI Express is in operation.	<i>Refer to User Manual Software Installation for the PC Cards cifX</i>			
<b>6</b>	<b>Notice on how to use the Software</b>	Use only <b>one</b> Software.				
6.1	<u>For the configuration, the firmware download and for the diagnosis, note:</u>	 <b>Important!</b> To avoid communication problems with the device, use the <u>USB interface</u> , the <u>serial interface</u> as well as the <u>cifX Device Driver</u> exclusively with <b>one</b> software, which is <b>SYCON.net</b> or <b>netX Configuration Tool</b> .	<i>Requirements for Operation of the PC Cards cifX</i>	48		
<b>7</b>	<b>Configuring Slave using SYCON.net</b>	<b>Download Firmware and Configuration</b> Use the corresponding Slave DTM in the configuration software <b>SYCON.net</b> .				
7.1	Firmware Download  <i>Firmware Slave:</i>	<ul style="list-style-type: none"> <li>- Start configuration software <b>SYCON.net</b>,</li> <li>- Create new project /Open existing project,</li> <li>- Insert Slave into configuration,</li> <li>- Select driver and assign device.</li> <li>- Select and download the firmware.</li> </ul> <table border="0" style="width: 100%;"> <tr> <td style="width: 50%; vertical-align: top;">           EtherCAT Slave,            EtherNet/IP Adapter,            Open Modbus/TCP,            POWERLINK-            Controlled-Node/Slave,            PROFINET IO Device,            sercos Slave,            VARAN Client,         </td> <td style="width: 50%; vertical-align: top;">           PROFIBUS DP Slave,            PROFIBUS MPI            Device,            CANopen Slave,            DeviceNet Slave,            CC-Link Slave         </td> </tr> </table>	EtherCAT Slave, EtherNet/IP Adapter, Open Modbus/TCP, POWERLINK- Controlled-Node/Slave, PROFINET IO Device, sercos Slave, VARAN Client,	PROFIBUS DP Slave, PROFIBUS MPI Device, CANopen Slave, DeviceNet Slave, CC-Link Slave	<i>See corresponding user manual</i>  <i>Device Names in SYCON.net</i>	55
EtherCAT Slave, EtherNet/IP Adapter, Open Modbus/TCP, POWERLINK- Controlled-Node/Slave, PROFINET IO Device, sercos Slave, VARAN Client,	PROFIBUS DP Slave, PROFIBUS MPI Device, CANopen Slave, DeviceNet Slave, CC-Link Slave					
7.2	Configuration cifX (Slave)	-Configure the PC card cifX (Slave).				
7.3	Download Configuration	- Download the configuration to the PC card cifX (Slave)				
<b>8</b>	<b>OR Configuring Slave using netX Configuration Tool</b>	<b>Download Firmware and Configuration</b>				
8.1	Downloading Firmware and Configuration (Slave)	<p>If SYCON.net was already used on the PC, stop the ODMV3 service. Therefore, select <b>Service &gt; Stop</b> from the context menu of the ODMV3 system tray icon.</p>  <p>The ODMV3 system tray icon changes to <b>ODMV3 Service stopped</b>.</p> 	<i>Requirements for Operation of the PC Cards cifX</i>	48		

#	Step	Description	For detailed information see manual / section	Page
		In the <b>netX Configuration Tool</b> : <ul style="list-style-type: none"> <li>- select the Firmware protocol,</li> <li>- Set the PC card cifX (Slave) parameters.</li> <li>- Select <b>Apply</b>.</li> </ul> The selected firmware and the configuration are downloaded to the replacement card cifX. The configuration is saved to the hard disk of the PC.	<i>See Operating Instruction Manual netX Configuration Tool for cifX, comX and netJACK</i>	
<b>9</b>	<b>Configuring Master using SYCON.net</b>	<b>Download Firmware and Configuration</b> Use the corresponding Master DTM in the configuration software <b>SYCON.net</b> .		
9.1	Firmware Download  <i>Firmware Master:</i>	<ul style="list-style-type: none"> <li>- Start configuration software <b>SYCON.net</b>,</li> <li>- Create new project /Open existing project,</li> <li>- Insert Master into configuration,</li> <li>- Select driver and assign device.</li> <li>- Select and download the firmware.</li> </ul> EtherCAT Master, PROFIBUS DP Master, EtherNet/IP Scanner, CANopen Master, PROFINET IO Controller, DeviceNet Master	<i>See corresponding user manual</i>  <i>Device Names in SYCON.net</i>	55
9.3	Configuration cifX (Master)	- Configure the PC card cifX (Master).	<i>Notes for the Configuration of the Master Device</i>	54
9.4	Download Configuration	- Download the configuration to the PC card cifX (Master).		
<b>10</b>	<b>Diagnosis by SYCON.net (Slave and Master)</b>	<b>Diagnosis, I/O Data</b> Use the corresponding Slave or Master DTM in the configuration software <b>SYCON.net</b> .		
10.1	Diagnosis Steps (Master and Slave)	<ul style="list-style-type: none"> <li>- In netDevice rightclick on device symbol.</li> <li>- Select context menu entry <b>Diagnosis</b>,</li> <li>- then select <b>Diagnosis &gt; General</b> or <b>Firmware Diagnosis</b>,</li> <li>- or select <b>Diagnosis &gt; Extended Diagnosis</b>.</li> </ul>	<i>See corresponding user manual</i>	
10.2	I/O Monitor	<ul style="list-style-type: none"> <li>- In netDevice rightclick on device symbol.</li> <li>- Select context menu entry <b>Diagnosis</b>,</li> <li>- then <b>Tools &gt; IO Monitor</b>.</li> <li>-Check the input or output data.</li> </ul>		
<b>11</b>	<b>OR Slave Diagnosis by netX Configuration Tool (only Slave)</b>	<b>Diagnosis</b>		
11.1	Diagnosis Steps (Slave)	If SYCON.net was already used on the PC, stop the ODMV3 service. Therefore, select <b>Service &gt; Stop</b> from the context menu of the ODMV3 system tray icon.  In the <b>netX Configuration Tool</b> : <ul style="list-style-type: none"> <li>- In the navigation area click on <b>Diagnostic</b>,</li> <li>- click in the <b>Diagnostic</b> pane to <b>Start</b>, to start the communication to the Master device and to run the diagnosis.</li> <li>- click on <b>Extended</b>, to run the extended diagnosis.</li> </ul>	<i>See Operating Instruction Manual netX Configuration Tool for cifX, comX and netJACK</i>	

Table 34: Steps for the Software and Hardware Installation, the Configuration and for the Diagnosis of a PC Card cifX Compact PCI, Mini PCI, Mini PCI Express and PCI-104 (Master and Slave)

## 4.2 Note on Exchange Service (Replacement Case)

For the exchange service (replacement case) of a PC card cifX (Master and Slave) obey to the following note.



**Important!** For PC cards cifX in terms of a device exchange service (replacement case) you must manually download the same firmware and configuration into the replacement card cifX, as into the preceding cifX.

## 4.3 Notes for the Configuration of the Master Device

To configure the Master, a device description file is required. Please note the following notes for the configuration of the Master Device:

System	Note
<i>EtherCAT Slave</i>	To configure the Master, an XML file (device description file) is required. The settings in the used Master must comply with the settings in the Slave to establish communication. Important parameters are: Vendor ID, Product Code, Serial Number, Revision Number, Output and Input Data Bytes.
	If the XML file <i>Hilscher cifX RE ECS V2.2.x.xml</i> is use/updated, the firmware with the version 2.2.x must be use/updated.
	The loadable firmware supports for the number of cyclic input data and for cyclic output data in total up to 400 bytes. If more than 200 bytes for input data or for output data should be exchanged via EtherCAT, then a customer specific XML file is necessary. Additionally the following formular applies: $(\text{number of input bytes} + 3)/4 + (\text{number of output bytes} + 3)/4$ must be less or equal to 100.
<i>EtherNet/IP Adapter</i>	To configure the Scanner/Master, an EDS file (device description file) is required. The settings in the used Scanner/Master must comply with the settings in the Adapter/Slave to establish communication. Important parameters are: Input, Output Data Bytes, Vendor ID, Product Type, Product Code, Major Rev, Minor Rev, IP Address and Netmask.
<i>POWERLINK-Controlled-Node/Slave</i>	To configure the Managing Node/Master, an XDD file (device description file) is required. The settings in the used Managing Node/Master must comply with the settings in the Controlled Node/Slave, to establish communication. Important parameters are: Vendor ID, Product Code, Serial Number, Revision Number, Node ID, Output and Input length.
<i>PROFINET IO Device</i>	To configure the Controller, a GSDML file (device description file) is required. The settings in the used Controller must comply with the settings in the Device to establish communication. Important parameters are: Station Name, Vendor ID, Device ID, Input and Output Data Bytes. Under Name of Station, the name must be typed which was also used in the configuration file of the master of this device. If no name chosen freely is used in the configuration file, then the name from the GSDML file is used.
<i>sercos Slave</i>	The sercos Master uses the sercos address to communicate with the slave. Some Masters will verify Device ID, Vendor Code, Input Data Size and Output Data Size and will do further communication to the Slave only if all these values match. Therefore the Master reads these parameters from the Slave and compares them with the configuration stored in the Master. The parameters Device ID, Vendor Code, Input Data Size and Output Data Size are part of the SDDML device description file. If for the configuration of the sercos Master SDDML files are used and a default value of one of these parameters was changed, then a SDDML file must be created in the configuration software via Export SDDML and then used in the configuration of the SERCOS Master.
<i>PROFIBUS DP Slave</i>	To configure the Master, a GSD file (device description file) is required. The settings in the used Master must comply with the settings in the Slave to establish communication. Important parameters are: Station Address, Ident Number, Baudrate and Config Data (the configuration data for the output and input length).
<i>CANopen Slave</i>	To configure the Master, an EDS file (device description file) is required. The settings in the used Master must comply with the settings in the Slave to establish communication. Important parameters are: Node Address and Baudrate.
<i>DeviceNet Slave</i>	To configure the Master, an EDS file (device description file) is required. The settings in the used Master must comply with the settings in the Slave to establish communication. Important parameters are: MAC ID, Baudrate, Produced Size, Consumed Size, Vendor ID, Product Type, Product Code, Major Rev, Minor Rev.

System	Note
CC-Link Slave	To configure the Master, a CSP file (device description file) is required. The settings in the used Master must comply with the settings in the Slave to establish communication. Important parameters are: Slave Station Address, Baudrate, Station Type and Vendor Code.

Table 35: Notes for the Configuration of the Master Device



Further information to the device description files you find under section on *Device Description Files cifX* page 18.

## 4.4 Device Names in SYCON.net

The following table contains the device names displayed for the single communication protocols in the configuration software SYCON.net.

The table shows the PC card cifX and which protocol can be used. Furthermore, the table shows, for which protocol which device must be selected from the device catalog to configure the PC card cifX with SYCON.net.

PC Cards cifX	Protocol	DTM Specific Group	Device Name in SYCON.net
CIFX 80-RE, CIFX 90-RE\F, CIFX 90E-RE\F, CIFX 90E-RE\ET\F, CIFX 90E-RE\MR\F, CIFX 90E-RE\MR\ET\F, CIFX 104C-RE, CIFX 104C-RE-R, CIFX 104C-RE\F, CIFX 104C-RE-R\F	EtherCAT Master	Master	CIFX RE/ECM
	EtherCAT Slave	Gateway/Stand-Alone Slave	CIFX RE/ECS
	EtherNet/IP Scanner (Master)	Master	CIFX RE/EIM
	EtherNet/IP Adapter (Slave)	Gateway/Stand-Alone Slave	CIFX RE/EIS
	Open Modbus/TCP	Gateway/Stand-Alone Slave	CIFX RE/OMB
	POWERLINK-Controlled-Node/Slave	Gateway/Stand-Alone Slave	CIFX RE/PLS
	PROFINET IO-Controller	Master	CIFX RE/PNM
	PROFINET IO-Device	Gateway/Stand-Alone Slave	CIFX RE/PNS
	sercos Master	Master	CIFX RE/S3M
	sercos Slave	Gateway/Stand-Alone Slave	CIFX RE/S3S
	VARAN Client (Slave)	Gateway/Stand-Alone Slave	CIFX RE/VRS
	CIFX 80-DP, CIFX 90-DP\F, CIFX 90E-DP\F, CIFX 90E-DP\ET\F, CIFX 90E-DP\MR\F, CIFX 90E-DP\MR\ET\F, CIFX 90E-2DP\ET\F CIFX 90E-2DP\MR\ET\F CIFX 90E-2DP\CO\ET\F CIFX 90E-2DP\CO\MR\ET\F CIFX 90E-2DP\DN\ET\F CIFX 90E-2DP\DN\MR\ET\F CIFX 104C-DP, CIFX 104C-DP-R, CIFX 104C-DP\F, CIFX 104C-DP-R\F	PROFIBUS DP Master	Master
PROFIBUS DP Slave		Gateway/ Stand-Alone Slave	CIFX DP/DPS
PROFIBUS MPI Device		Gateway/ Stand-Alone Slave	CIFX DP/MPI

PC Cards cifX	Protocol	DTM Specific Group	Device Name in SYCON.net
CIFX 80-CO, CIFX 90-CO\F, CIFX 90E-CO\F, CIFX 90E-CO\ET\F, CIFX 90E-CO\MR\F, CIFX 90E-CO\MR\ET\F, CIFX 90E-2CO\ET\F CIFX 90E-2CO\MR\ET\F CIFX 90E-2DP\CO\ET\F CIFX 90E-2DP\CO\MR\ET\F CIFX 90E-2CO\DN\ET\F CIFX 90E-2CO\DN\MR\ET\F CIFX 104C-CO, CIFX 104C-CO-R, CIFX 104C-CO\F, CIFX 104C-CO-R\F	CANopen Master	Master	CIFX CO/COM
	CANopen Slave	Gateway/ Stand-Alone Slave	CIFX CO/COS
CIFX 80-DN, CIFX 90-DN\F, CIFX 90E-DN\F, CIFX 90E-DN\ET\F, CIFX 90E-DN\MR\F, CIFX 90E-DN\MR\ET\F, CIFX 90E-2DN\ET\F CIFX 90E-2DN\MR\ET\F CIFX 90E-2DP\DN\ET\F CIFX 90E-2DP\DN\MR\ET\F CIFX 90E-2CO\DN\ET\F CIFX 90E-2CO\DN\MR\ET\F CIFX 104C-DN, CIFX 104C-DN-R, CIFX 104C-DN\F, CIFX 104C-DN-R\F	DeviceNet Master	Master	CIFX DN/DNM
	DeviceNet Slave	Gateway/ Stand-Alone Slave	CIFX DN/DNS
CIFX 90-CC\F CIFX 90E-CC\ET\F CIFX 90E-CC\MR\ET\F CIFX 104C-CC\F	CC-Link Slave	Gateway/ Stand-Alone Slave	CIFX CC/ CCS

Table 36: Device Names in SYCON.net by Communication Protocol



## 4.5 Update for Firmware, Driver and Software



**Note:** As a pre-requirement for the software update the project files, the configuration files and firmware files are to be saved.

At existing hardware installation the firmware, the driver and the configuration software must be updated according to the versions given in section *Notes on Hardware, Firmware, Software and Driver* on page 10. The following graphic gives an overview:

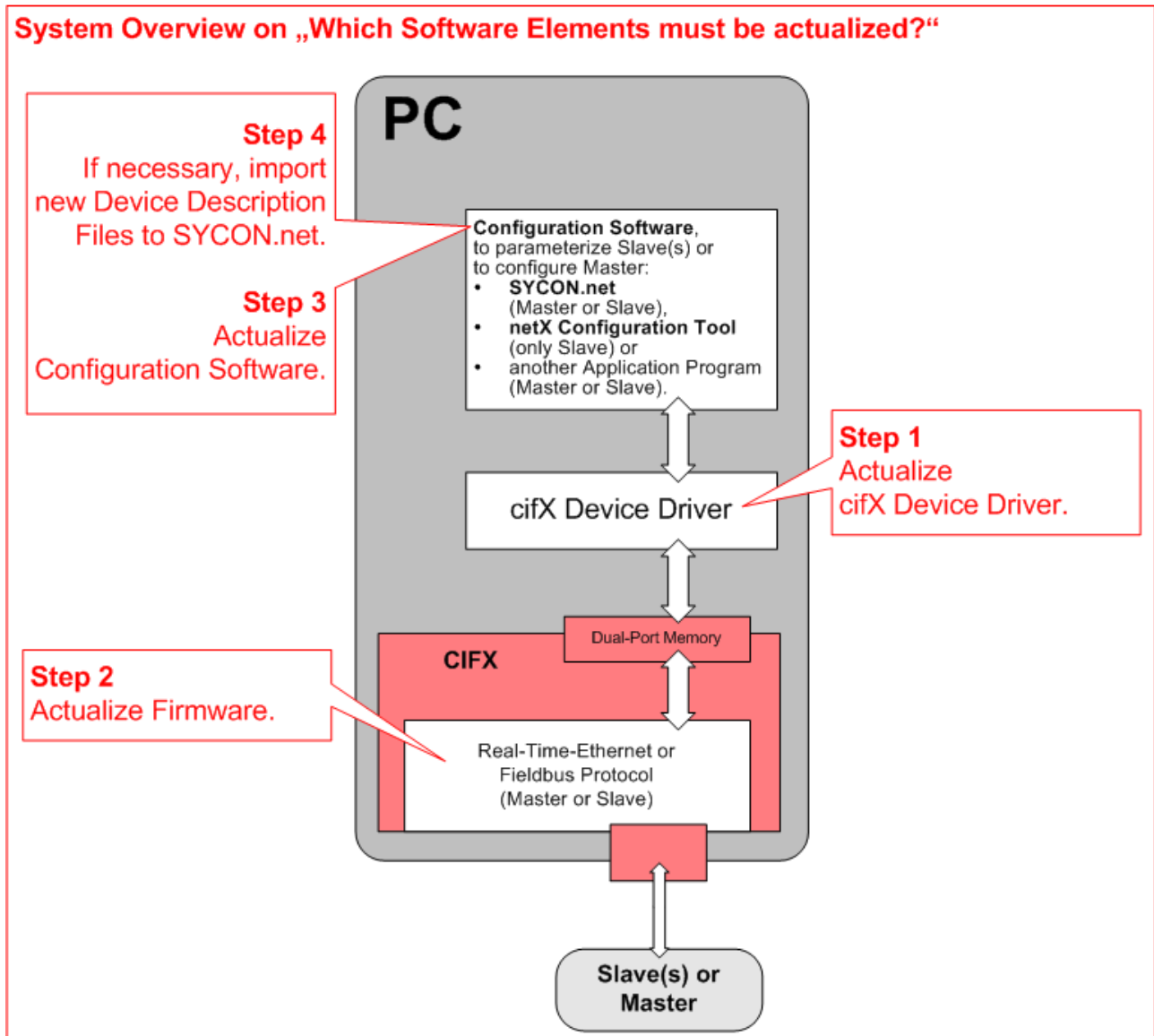

Figure 1: System Overview cifX to update Firmware, Driver and Software



Note the specific details for devices with **DMA Mode** in section *The Function „DMA Mode“* on page 41.

# 5 Device Drawings

## 5.1 PC Cards cifX Compact PCI

### 5.1.1 CIFX 80-RE

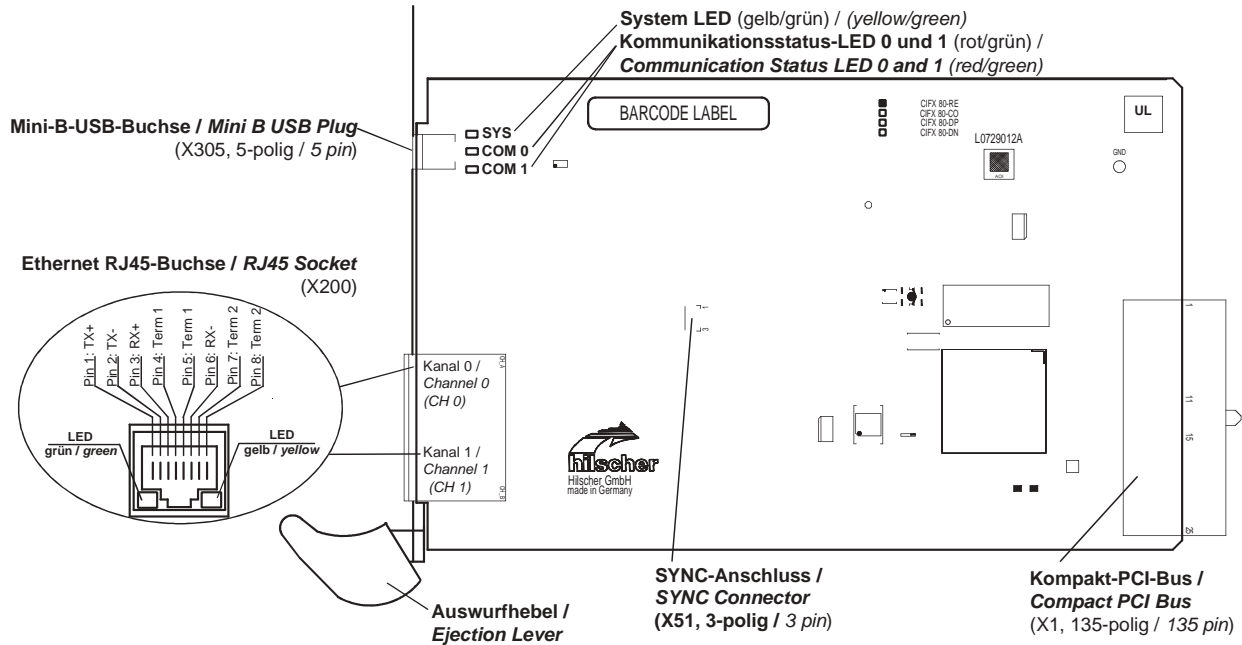

Figure 2: CIFX 80-RE\*



**Note:** \*Device supports Auto Crossover Function. With loaded EtherCAT Master firmware only the RJ45 channel 0 can be used, channel 1 is deactivated. Beginning with the EtherCAT Master firmware version 3 channel 1 can be reactivated if redundancy is activated. For Open Modbus/TCP with V2.3.4.0 and higher both RJ45 channels can be used.

The figure below shows the front plate of the PC cards CIFX 80-RE:

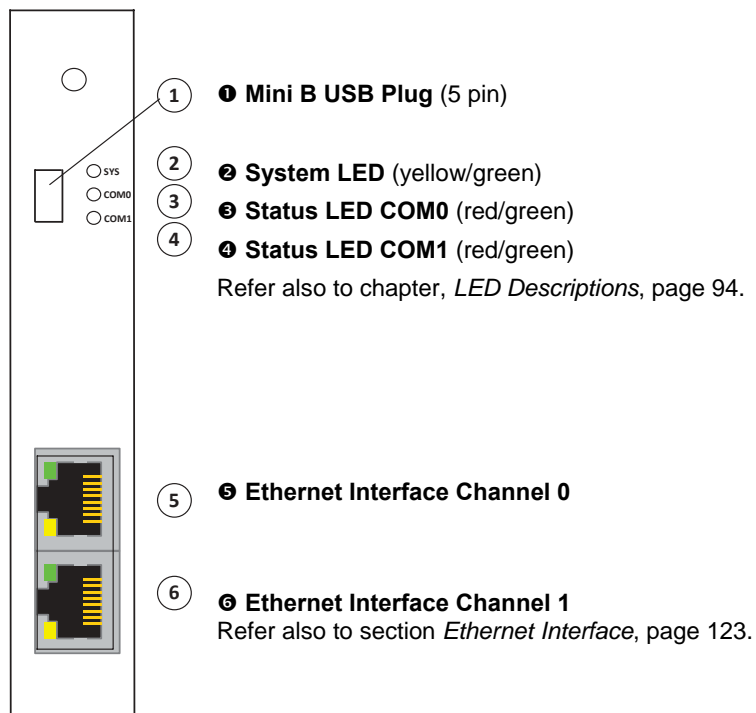

Figure 3: Front Plate CIFX 80-RE

### 5.1.2 CIFX 80-DP

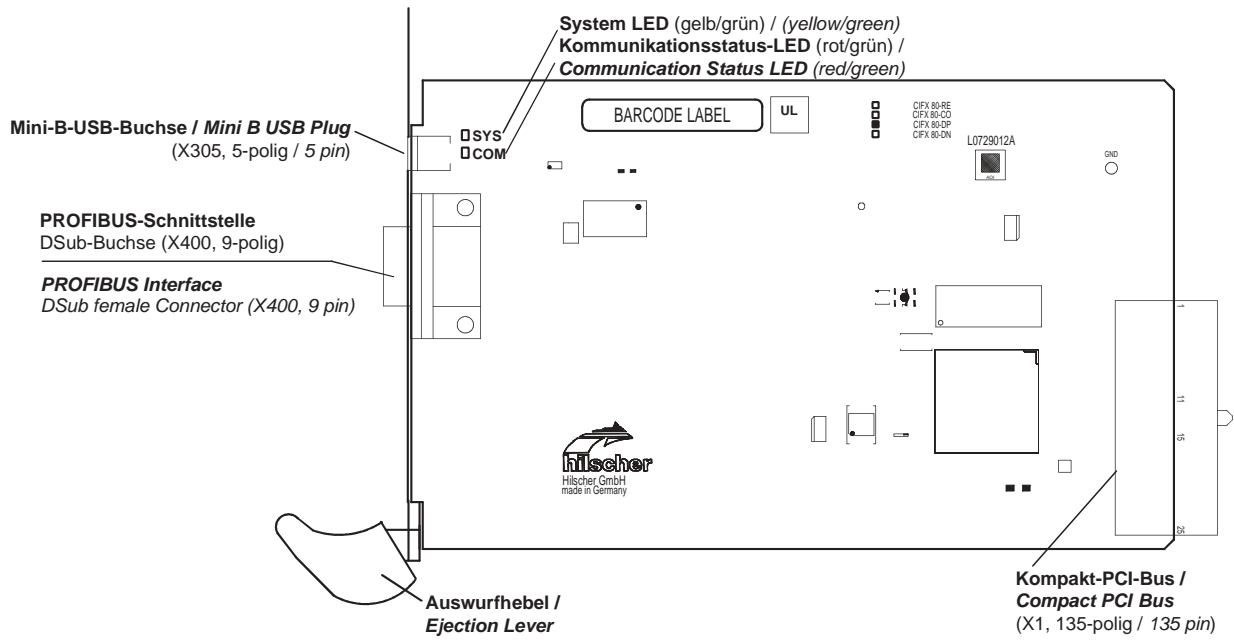

Figure 4: CIFX 80-DP

The figure below shows the front plate of the PC cards CIFX 80-DP:

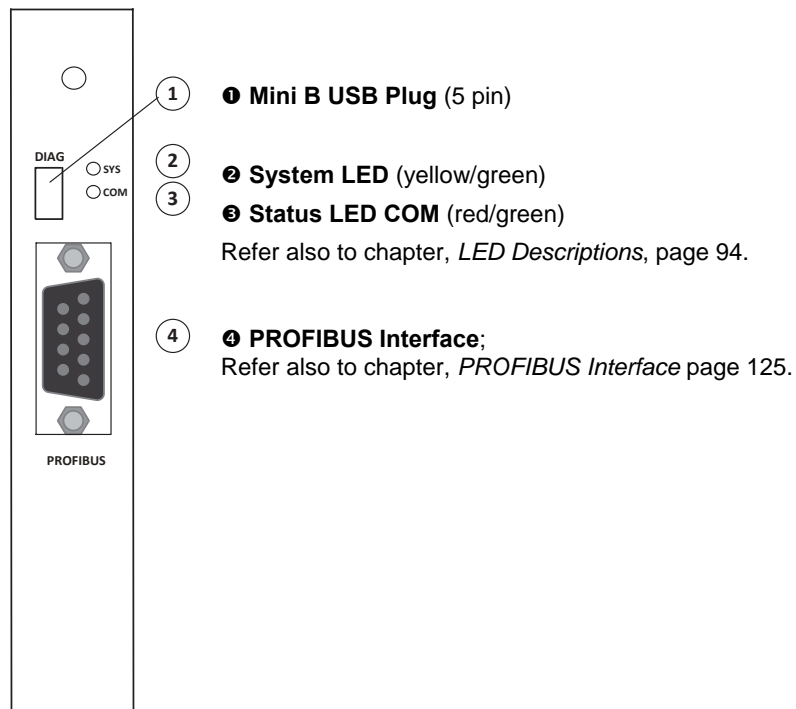

Figure 5: Front Plate CIFX 80-RE

### 5.1.3 CIFX 80-CO

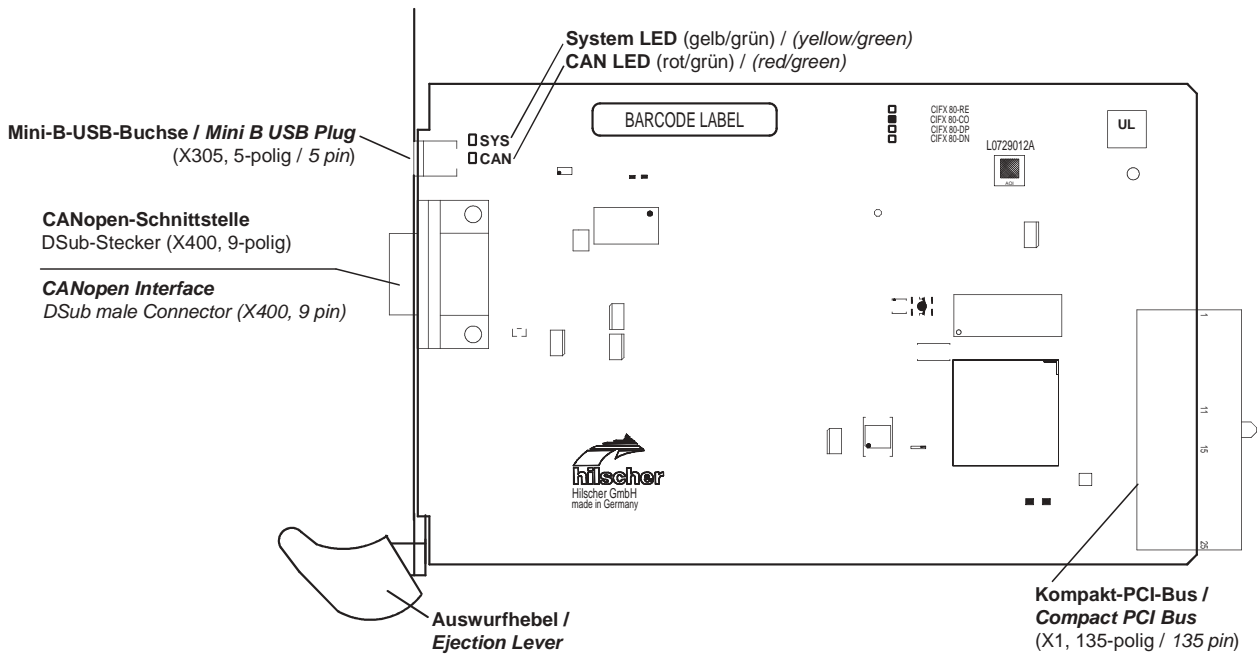

Figure 6: CIFX 80-CO

The figure below shows the front plate of the PC cards CIFX 80-CO:

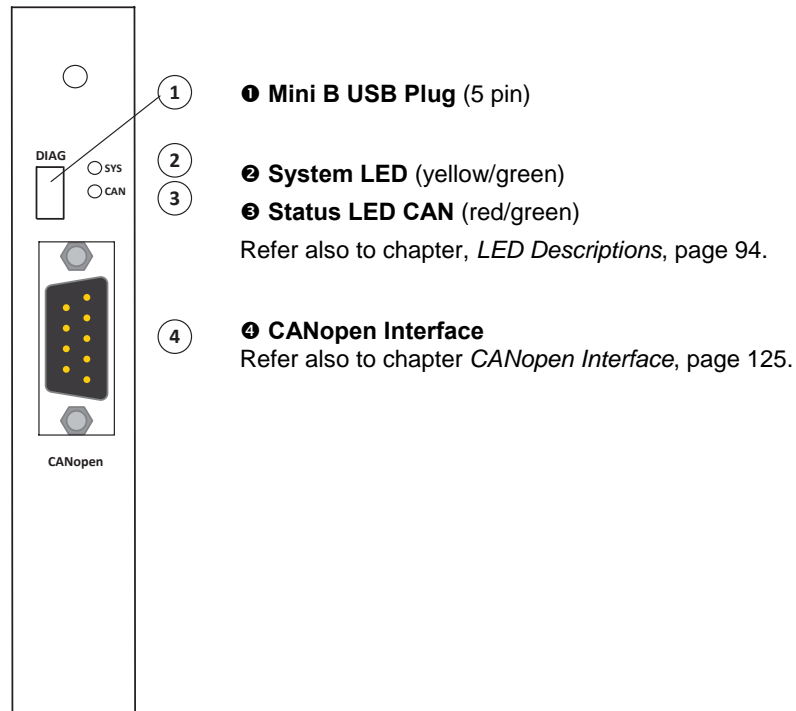

Figure 7: Front Plate CIFX 80-CO

### 5.1.4 CIFX 80-DN

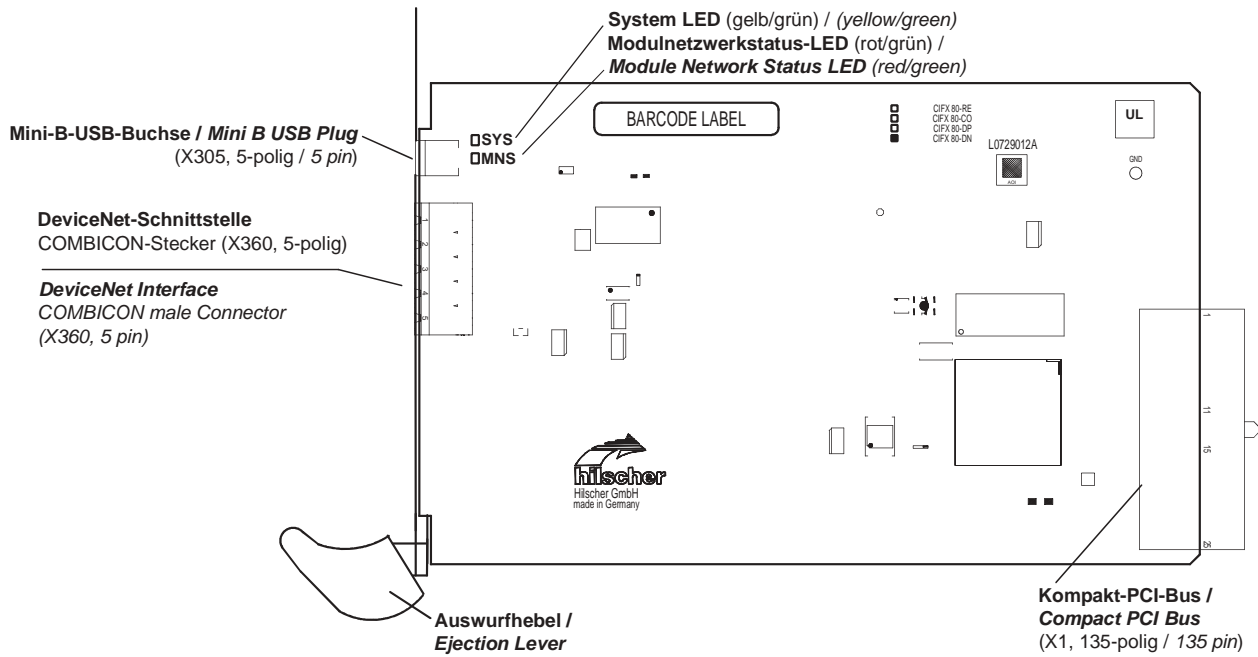

Figure 8: CIFX 80-DN



For the pin assignment of the **SYNC** Connector refer to section *Pin Assignment SYNC Connector, X51* on page 131. For further information on the **Mini-B USB** Connector refer to section *Mini-B USB Connector (5 Pin)* on page 127.



**Note:** The front plate cutout for the CombiCon male Connector is at the PCB side 0.5 mm outside of the standard front plate cutout.

The figure below shows the front plate of the PC cards CIFX 80-DN:

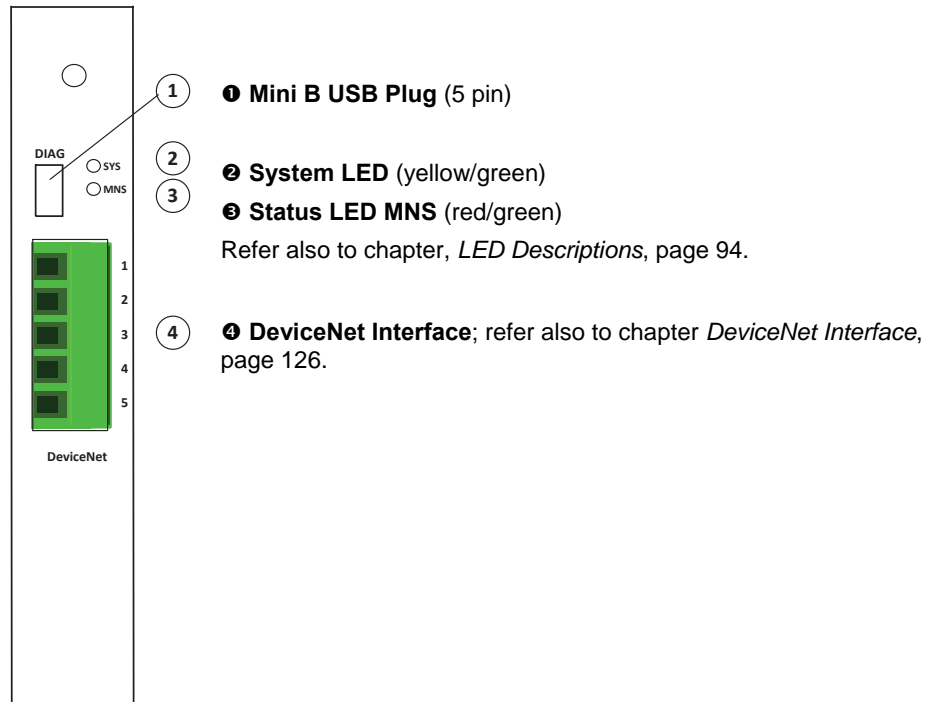

Figure 9: Front Plate CIFX 80-DN

## 5.2 PC Cards cifX Mini PCI and Mini PCI Express

### 5.2.1 CIFX 90-RE\F, CIFX 90E-RE\F and MR and/or ET Variants

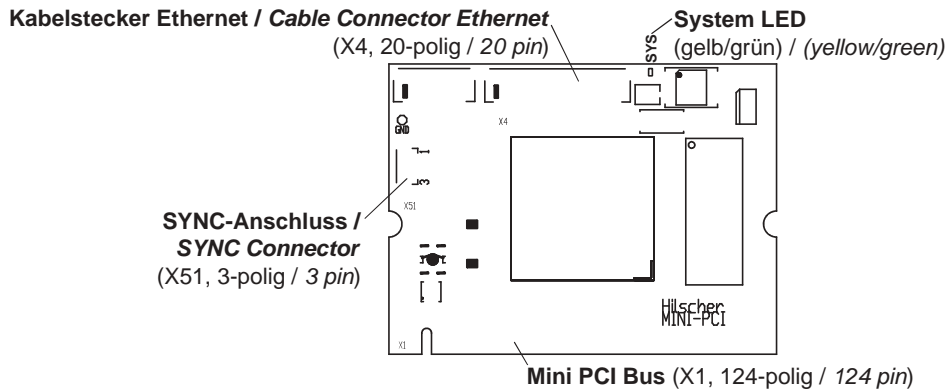

Figure 10: Basic Card CIFX 90 for CIFX 90-RE\F\*

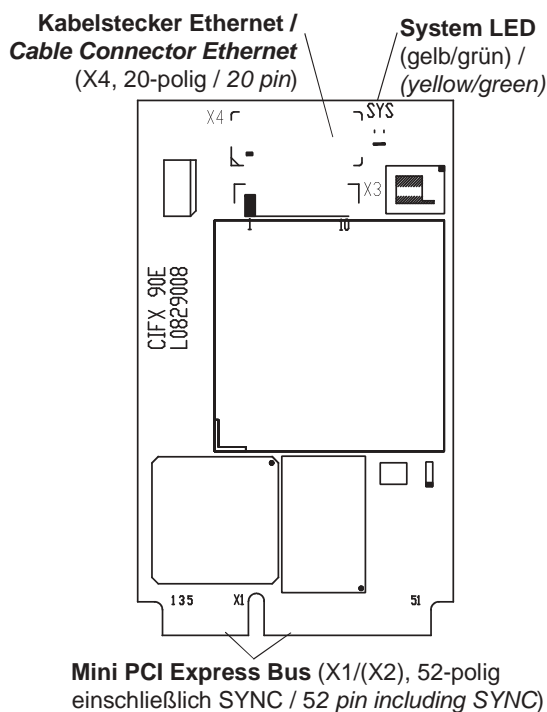

Figure 11: Basic Card CIFX 90E (for CIFX 90E-RE\F) respectively equally looking basic Card CIFX 90E\ET (for CIFX 90E-RE\ET\F\*)

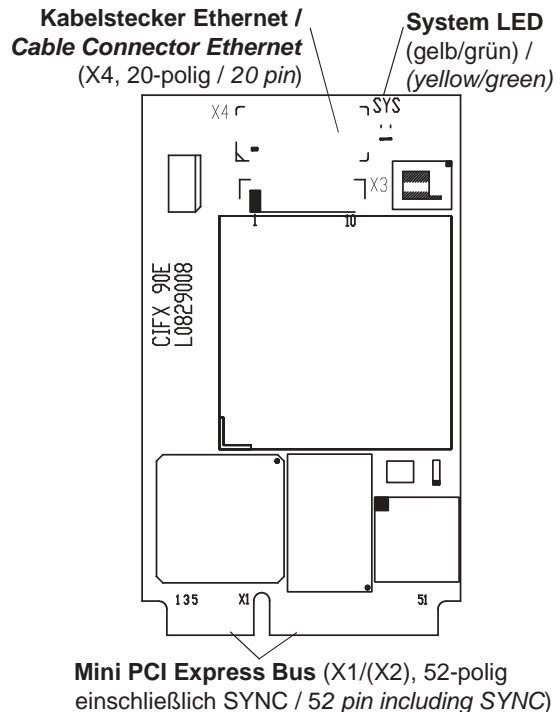

Figure 12: Basic Card CIFX 90EMR (for CIFX 90E-RE\MR\F) respectively equally looking basic Card CIFX 90EMR\ET (for CIFX 90E-RE\MR\ET\F\*)



**Notes:** \*Device supports Auto Crossover Function.

The cable connector Ethernet X4 is white colored.

The matrix label is positioned on the reverse side of the card, refer to section *Reverse Side CIFX 90-XX\F, CIFX 90E-XX\F and Variants* on page 64.



For the **pin assignment**

- of the **Mini PCI** bus refer to section *Pin Assignment for Mini PCI Bus, X1* on page 133 or
- of the **Mini PCI Express** bus to section *Pin Assignment for Mini PCI Express Bus / SYNC Connector (Bootstart), X1/X2* on page 135 or
- of the **SYNC** Connector: (1) Of PC cards CIFX 90-RE\F to section *Pin Assignment SYNC Connector, X51* on page 131.
- (2) For the PC cards CIFX 90E-RE\F, CIFX 90E-RE\ET\F, CIFX 90E-RE\MR\F and CIFX 90E-RE\MR\ET\F the SYNC pins are on the Mini PCI Express bus (Pin 46, 44), refer to section *Pin Assignment for Mini PCI Express Bus / SYNC Connector (Bootstart), X1/X2*, on page 135.

For information on the **card height** refer to section the *Notes on the Card Height - PC Card cifX Mini PCI and Mini PCIe* on page 44.

### 5.2.2 CIFX 90-FB\F, CIFX 90E-FB\F and MR and/or ET Variants

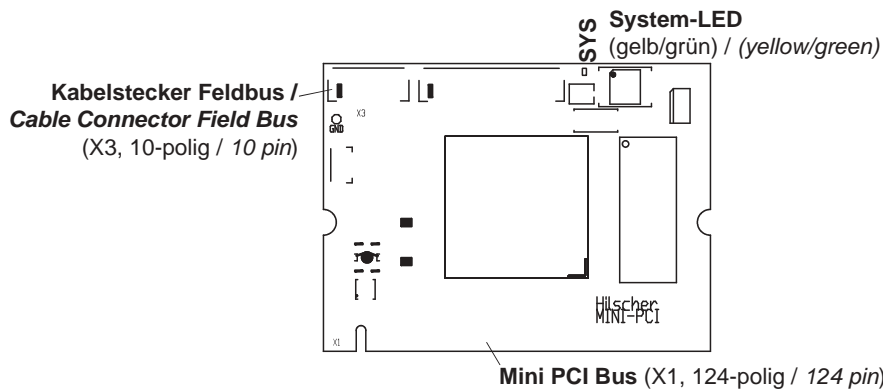

Figure 13: Basic Card CIFX 90 for CIFX 90-DP\F, CIFX 90-CO\F, CIFX 90-DN\F

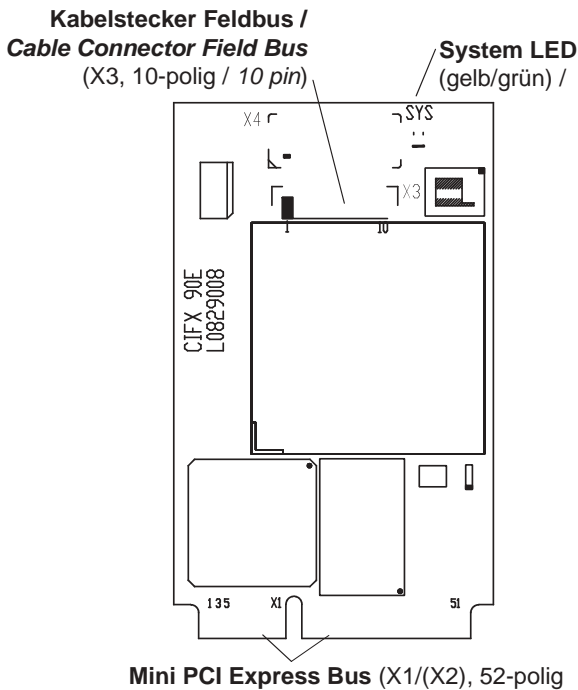

Figure 14: Basic Card CIFX 90E (for CIFX 90E-FB\F) respectively equally looking basic Card CIFX 90E\ET (for CIFX 90E-FB\ET\F)

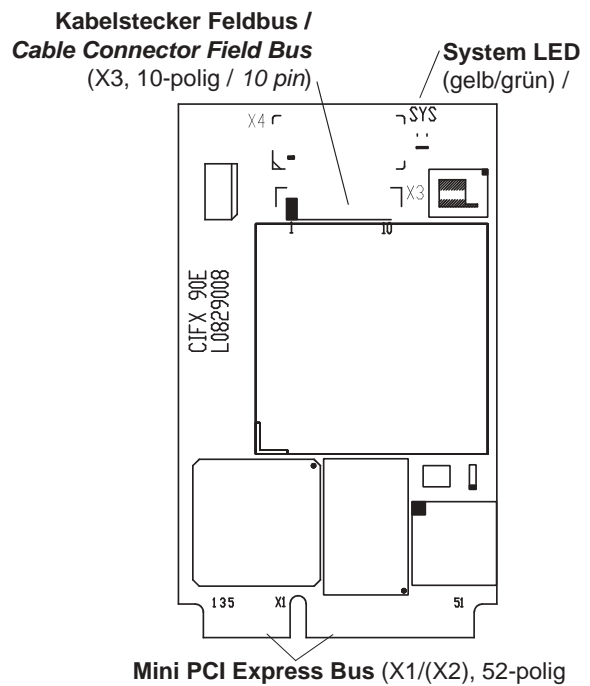

Figure 15: Basic Card CIFX 90EMR for (CIFX 90E-FBMR\F) respectively equally looking basic Card CIFX 90EMR\ET (for CIFX 90E-FBMR\ET\F)



**Notes:** The cable connector fieldbus X3 is black colored.  
The matrix label is positioned on the reverse side of the card, refer to section *Reverse Side CIFX 90-XX\F, CIFX 90E-XX\F and Variants* on page 64.



For the **pin assignment**

- of the **Mini PCI** bus refer to section *Pin Assignment for Mini PCI Bus, X1* on page 133 or
- of the **Mini PCI Express** bus to section *Pin Assignment for Mini PCI Express Bus / SYNC Connector (Bootstart), X1/X2* on page 135 or for information on the **card height** refer to section the *Notes on the Card Height - PC Card cifX Mini PCI and Mini PCIe* on page 44.

### 5.2.3 CIFS 90E-2FB\ET\F and CIFS 90E-2FB\MR\ET\F

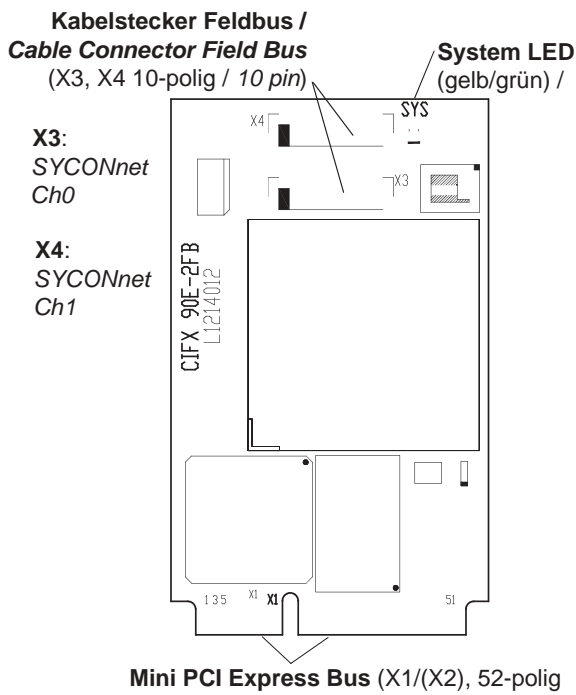

Figure 16: Basic Card CIFS 90E-2FB\ET\F for CIFS 90E-2FB\ET\F

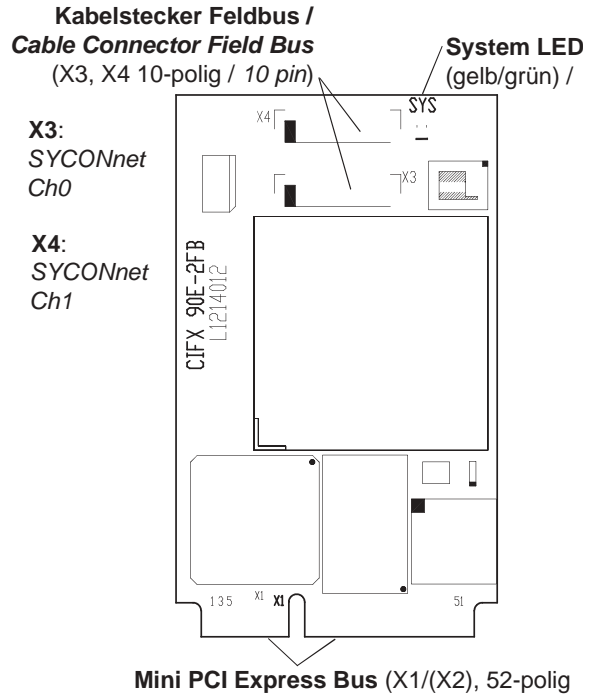

Figure 17: Basic Card CIFS 90E-2FB\MR\ET\F for CIFS 90E-2FB\MR\ET\F



**Notes:** The cable connectors fieldbus X3 and X4 are black colored. The matrix label is positioned on the reverse side of the card, refer to section *Reverse Side CIFS 90-XX\F, CIFS 90E-XX\F and Variants* on page 64.



For the **pin assignment** of the **Mini PCI Express** bus to section *Pin Assignment for Mini PCI Express Bus / SYNC Connector (Bootstart), X1/X2* on page 135 or for information on the **card height** refer to section the *Notes on the Card Height - PC Card cifX Mini PCI and Mini PCIe* on page 44.

### 5.2.4 Reverse Side CIFS 90-XX\F, CIFS 90E-XX\F and Variants

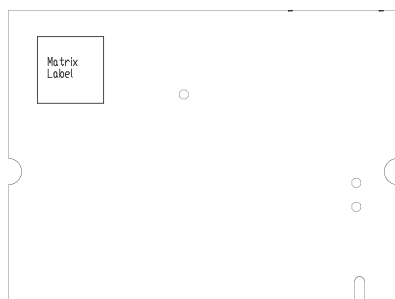

Figure 18: Reverse Side CIFS 90-XX\F

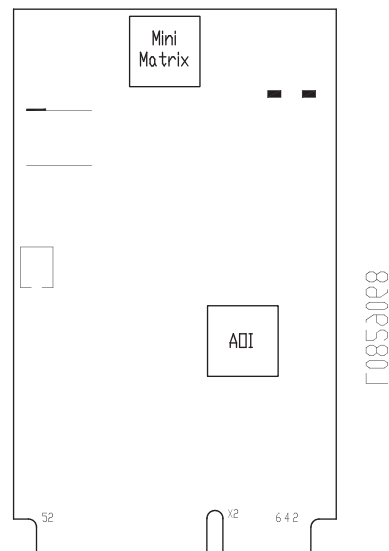

Figure 19: Reverse Side CIFS 90E-XX\F



## 5.3 PC Cards cifX PCI-104

### 5.3.1 CIFX 104C-RE, CIFX 104C-RE-R

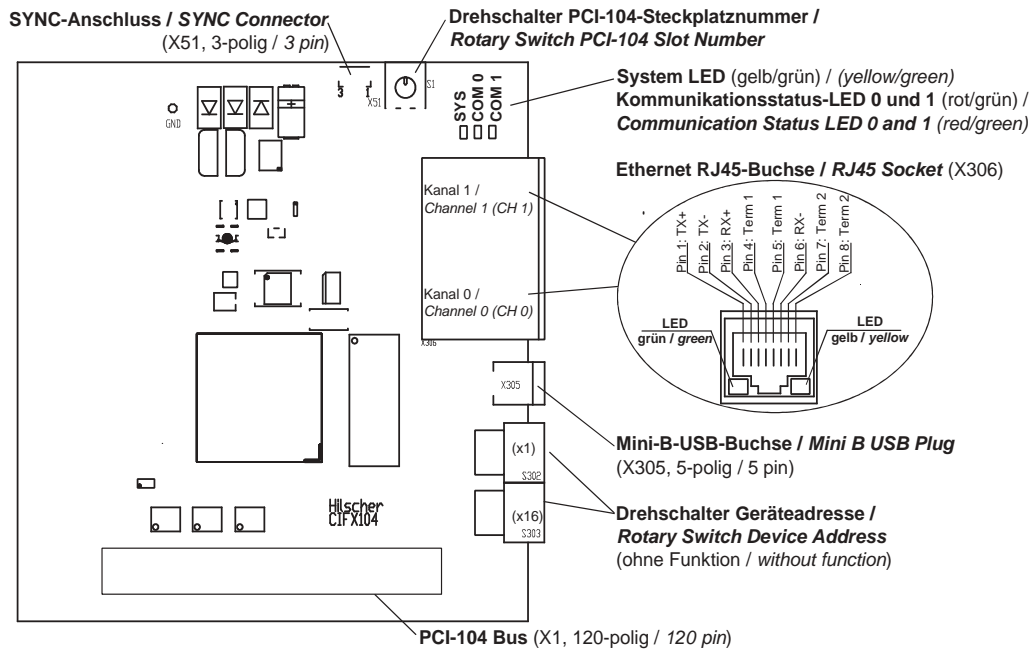

Figure 20: CIFX 104C-RE\*

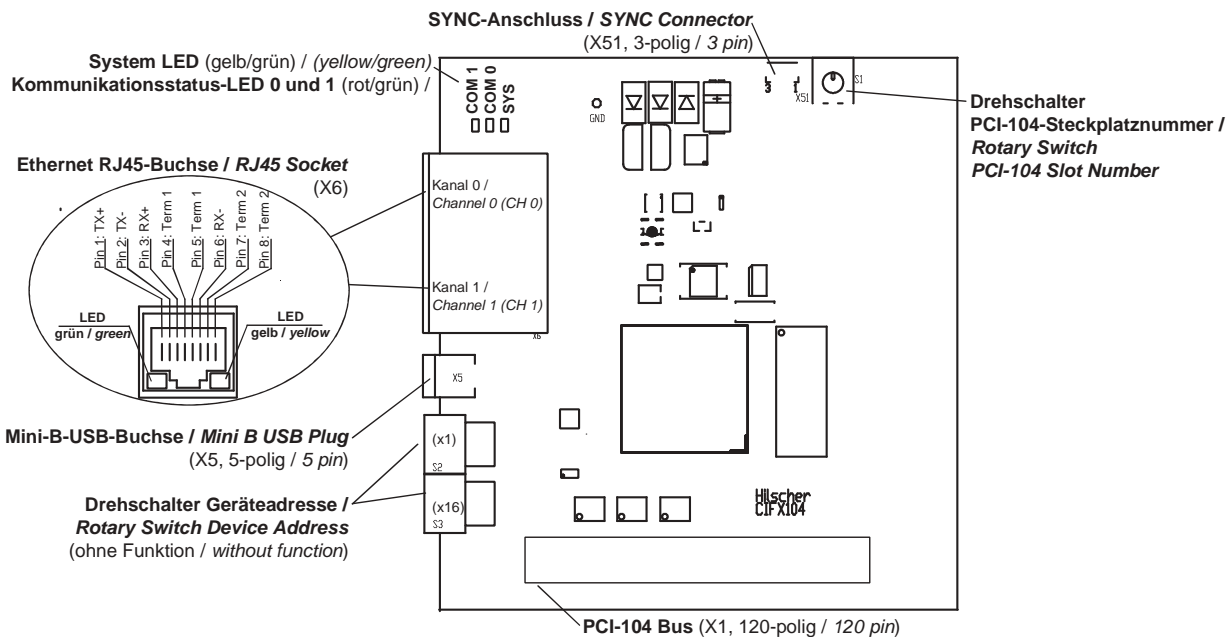

Figure 21: CIFX 104C-RE-R\*



**Note:** \*Device supports Auto Crossover Function. Note also: With loaded EtherCAT Master firmware only the RJ45 channel 0 can be used, channel 1 is deactivated. Beginning with the EtherCAT Master firmware version 3 channel 1 can be reactivated if redundancy is activated. For Open Modbus/TCP with V2.3.4.0 and higher both RJ45 channels can be used.



The meaning of the **LEDs** depends from the loaded firmware. See chapter *LED Descriptions* beginning from page 94. For the pin assignment of the SYNC Connector refer to section *Pin Assignment SYNC Connector, X51* on page 131. For further information on the **Mini-B USB** Connector refer to section *Mini-B USB Connector (5 Pin)* on page 127.

### 5.3.2 CIFX 104C-RE\F, CIFX 104C-RE-R\F

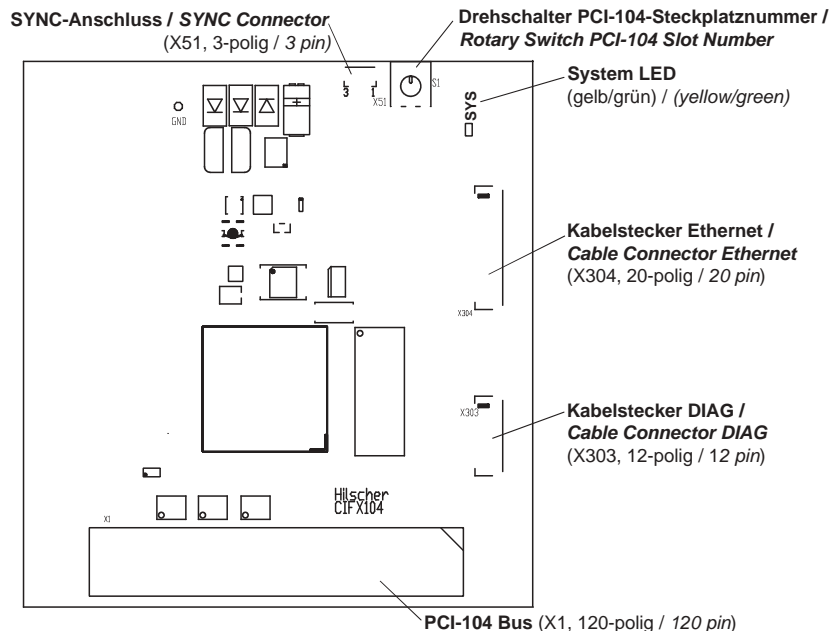

Figure 22: Basic Card for CIFX 104C-RE\F

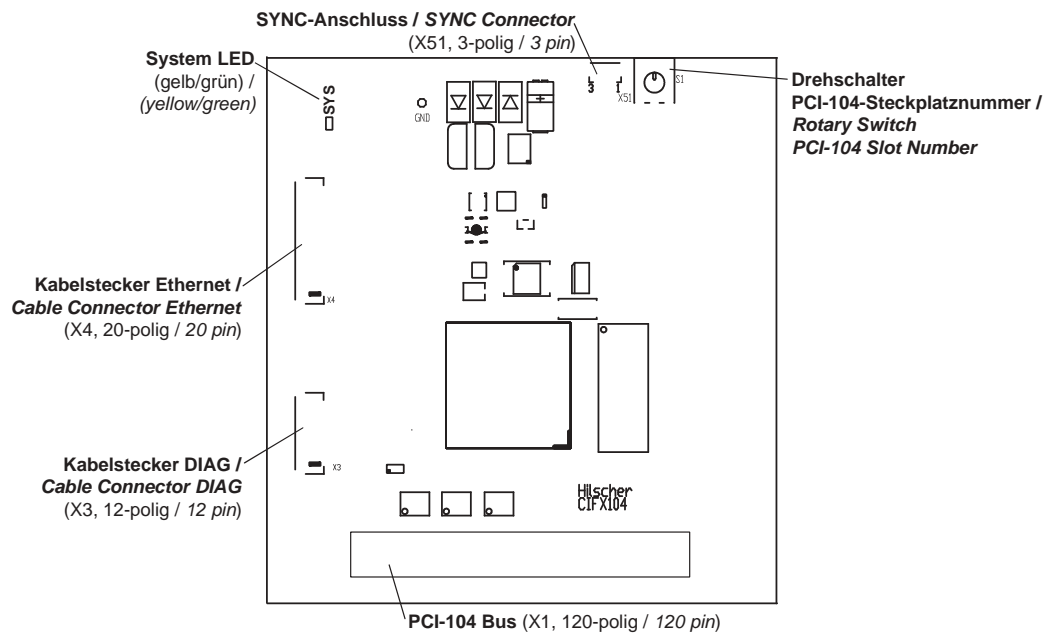

Figure 23: Basic Card for CIFX 104C-RE-R\F



For the **SYNC** pin assignment of the SYNC Connector refer to section *Pin Assignment SYNC Connector, X51* on page 131.



**Note:** If the **AIFX-DIAG** diagnostic assembly interface is connected to the basic card for the PC card CIFX 104C-RE\F or CIFX 104C-RE-R\F, the **Mini-B USB** connector on the AIFX-DIAG can be used beginning with the hardware revision 5 of the PC card cifX.

### 5.3.3 CIFX 104C-DP, CIFX 104C-DP-R

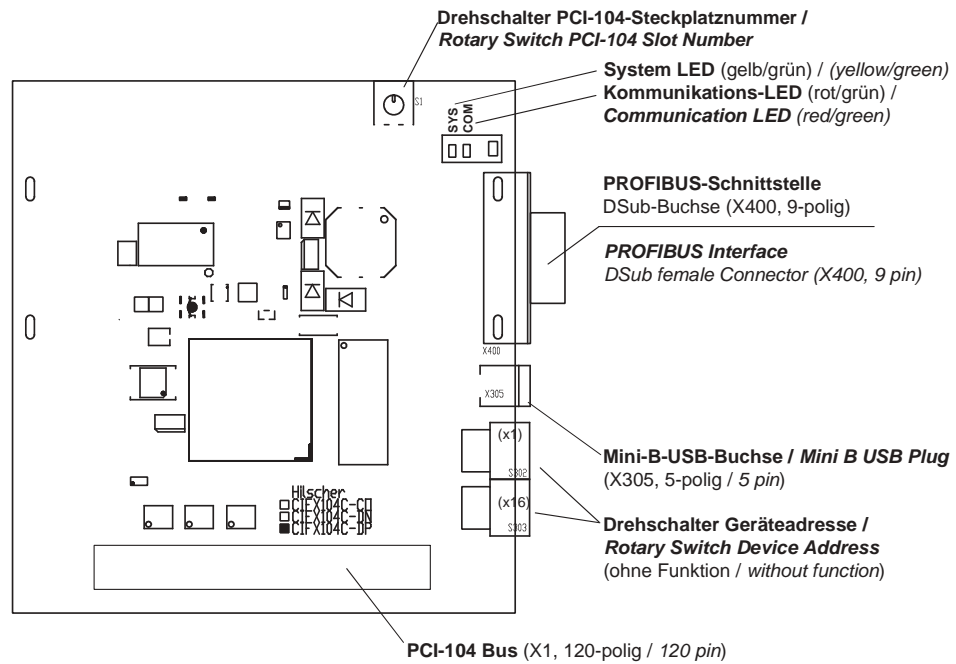

Figure 24: CIFX 104C-DP

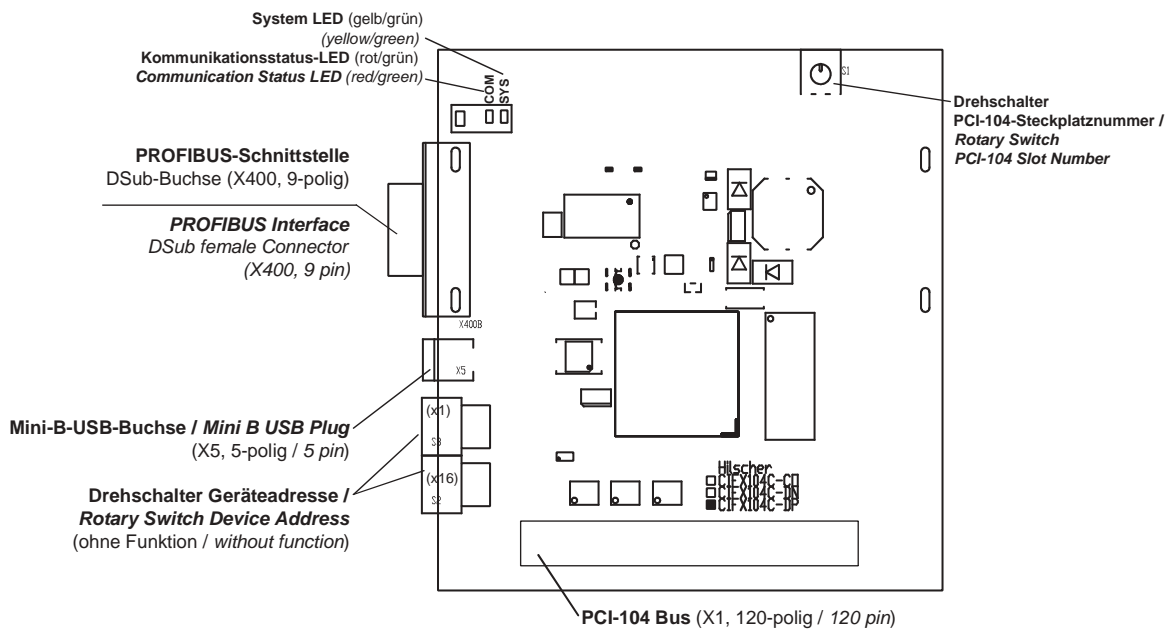

Figure 25: CIFX 104C-DP-R



For further information on the **Mini-B USB Connector** refer to section *Mini-B USB Connector (5 Pin)* on page 127.

### 5.3.4 CIFS 104C-CO, CIFS 104C-CO-R

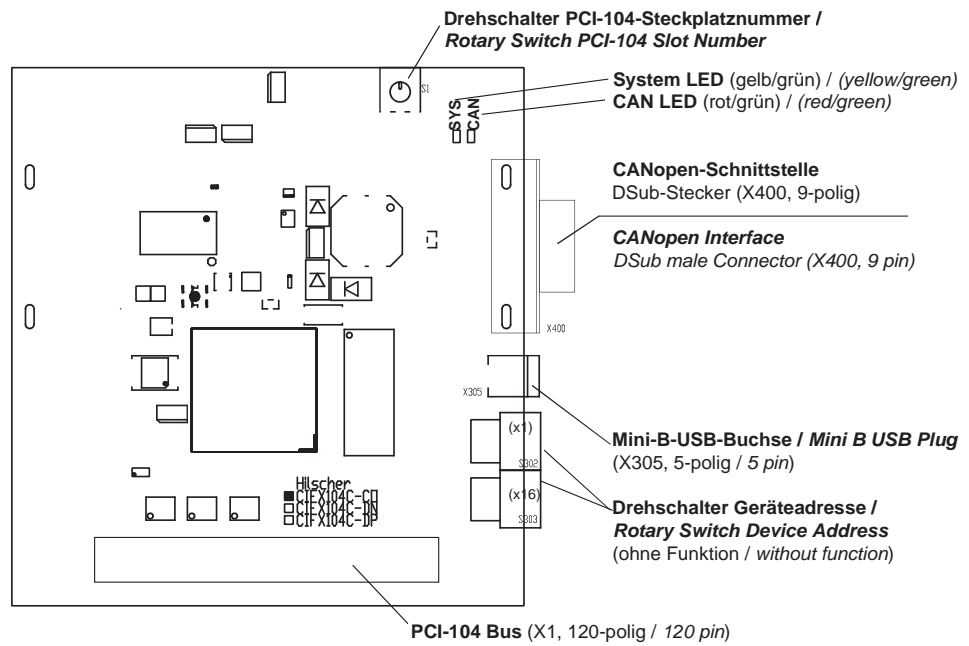

Figure 26: CIFS 104C-CO

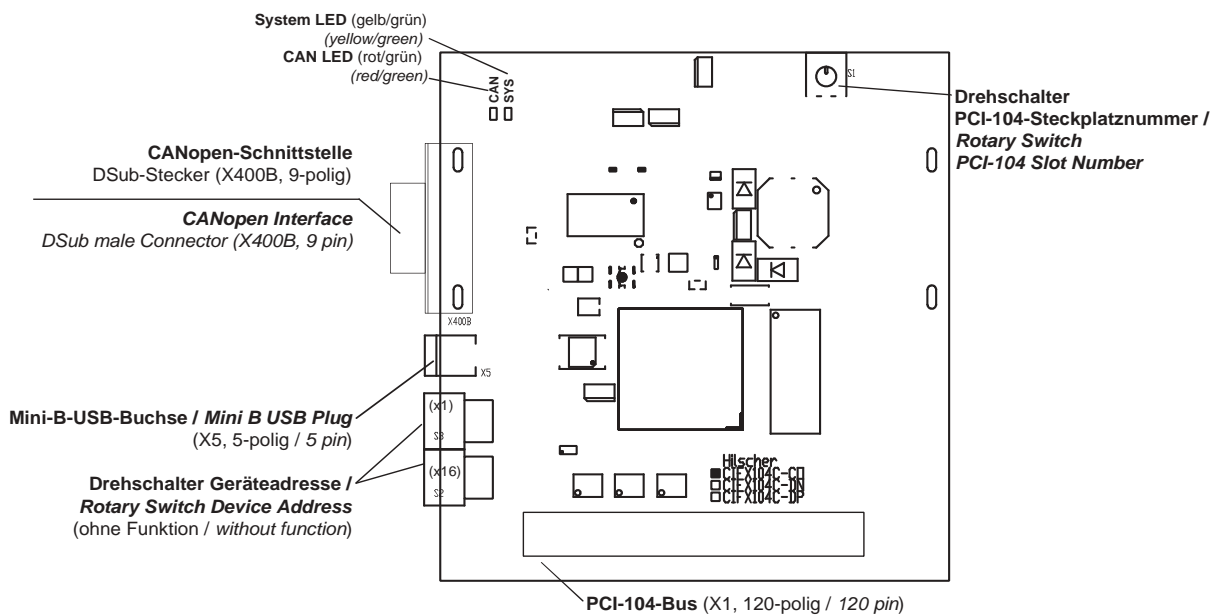

Figure 27: CIFS 104C-CO-R



For further information on the **Mini-B USB** Connector refer to section *Mini-B USB Connector (5 Pin)* on page 127.

### 5.3.5 CIFX 104C-DN, CIFX 104C-DN-R

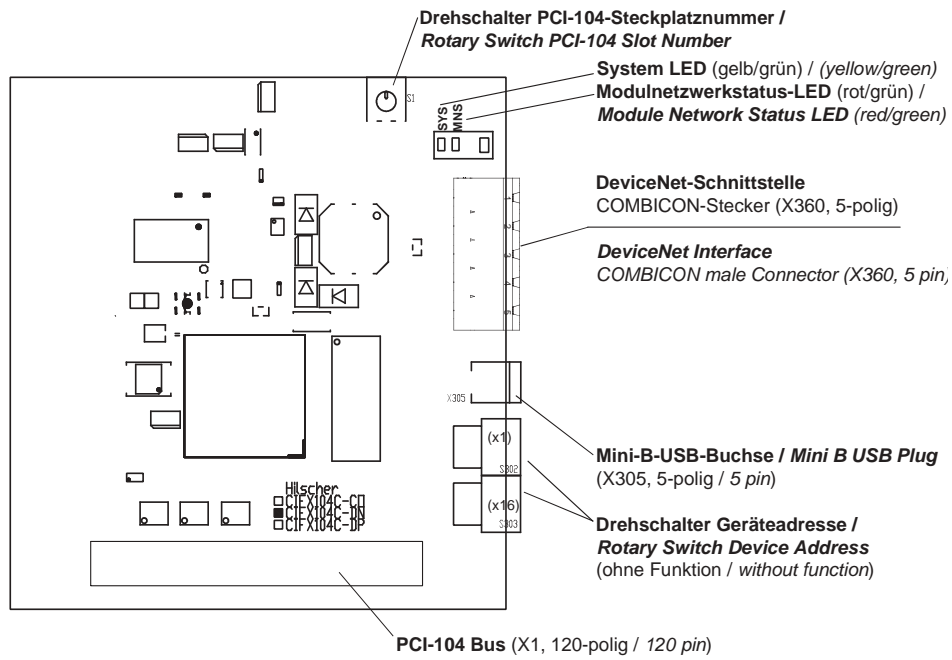

Figure 28: CIFX 104C-DN

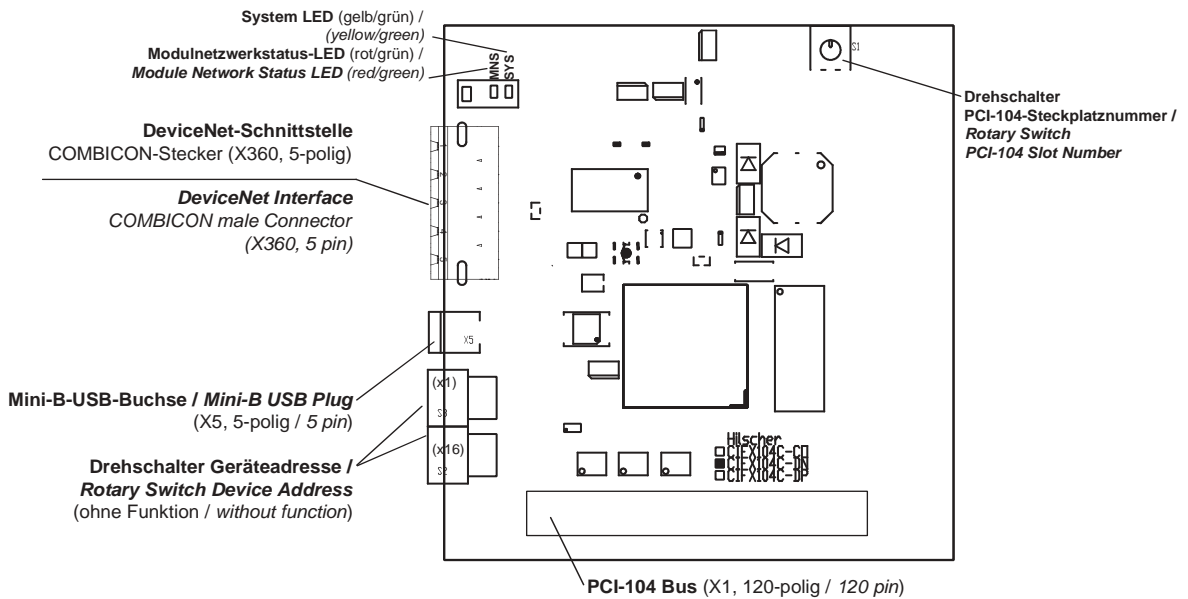

Figure 29: CIFX 104C-DN-R



For further information on the **Mini-B USB Connector** refer to section *Mini-B USB Connector (5 Pin)* on page 127.

### 5.3.6 CIFX 104C-DP\F, CIFX 104C-CO\F, CIFX 104C-DN\F, CIFX 104C-CC\F

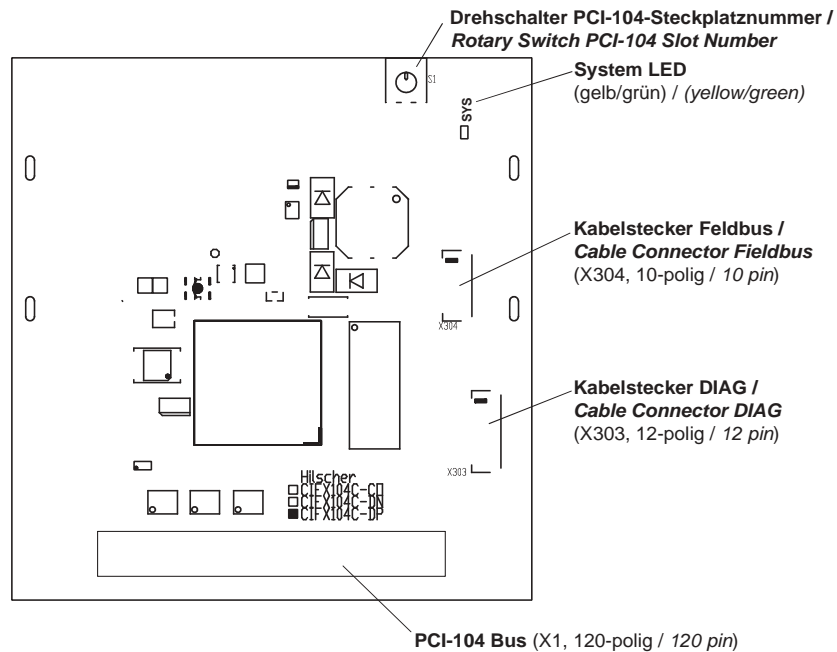

Figure 30: Basic Card CIFX 104C-FB\F for CIFX 104C-DP\F, CIFX 104C-CO\F, CIFX 104C-DN\F, CIFX 104C-CC\F

### 5.3.7 CIFX 104C-DP-R\F, CIFX 104C-CO-R\F, CIFX 104C-DN-R\F

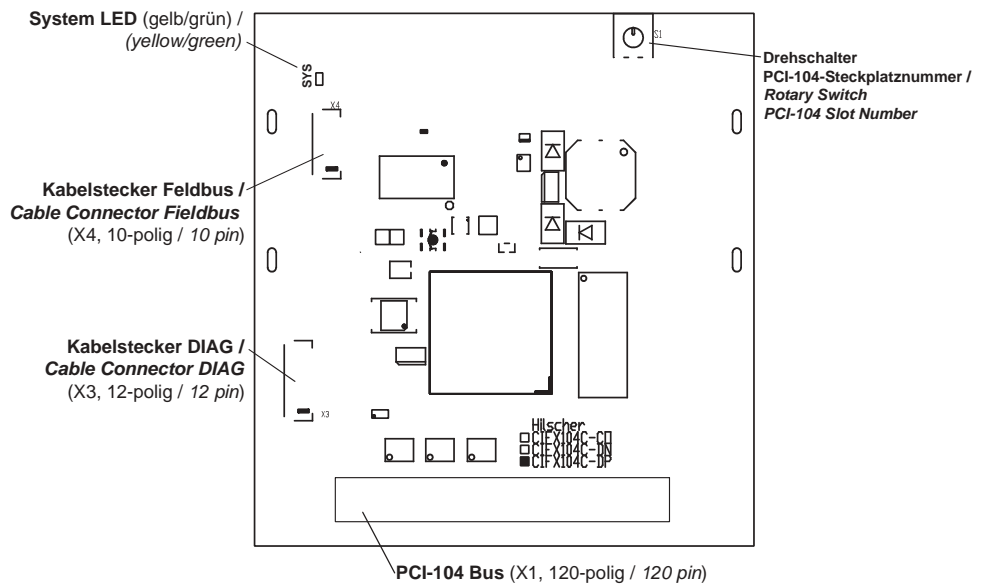

Figure 31: Basic Card CIFX 104C-FB-R\F for CIFX 104C-DP-R\F, CIFX 104C-CO-R\F, CIFX 104C-DN-R\F

### 5.3.8 Reverse Side CIFX 104C-XX (all Basic Cards and Variants)

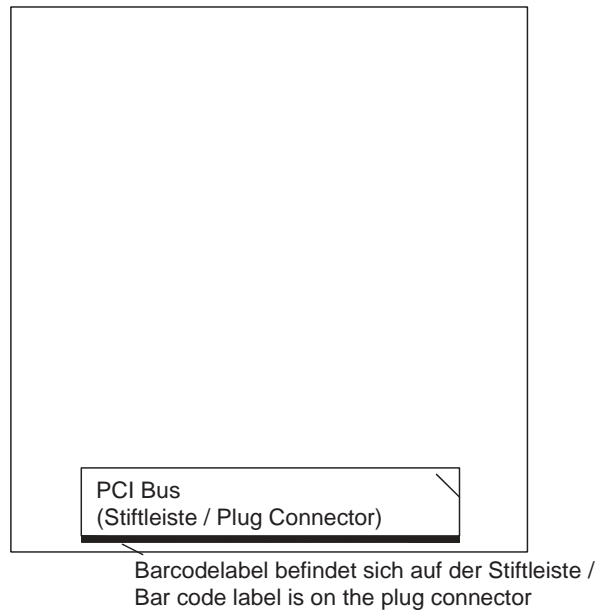

Figure 32: Reverse Side CIFX 104C-XX (all Basic Cards and Variants)

## 5.4 AIFX Assembly Interfaces

### 5.4.1 Ethernet - AIFX-RE

Only for CIFX 90-RE\F, CIFX 90E-RE\F, CIFX 90E-RE\ET\F, CIFX 90E-RE\MR\F, CIFX 90E-RE\MR\ET\F, CIFX 104C-RE\F, CIFX 104C-RE-R\F.

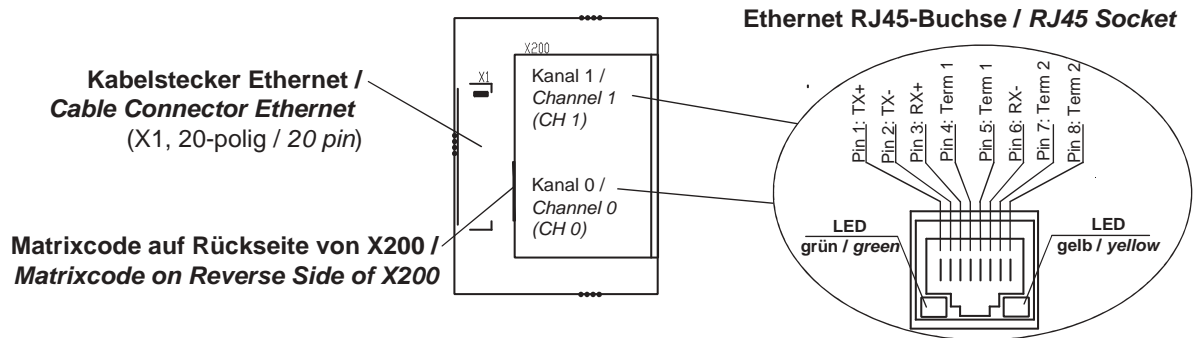
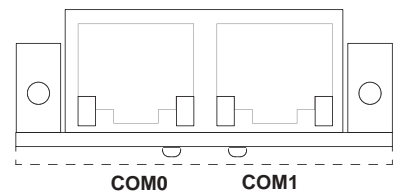
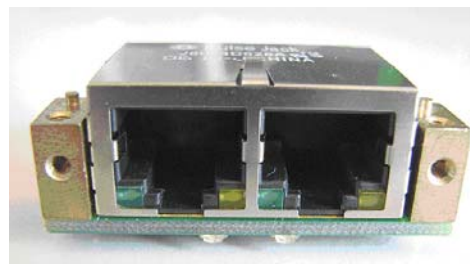

Figure 33: Ethernet Assembly Interface (AIFX-RE)\*



**Note:** \*Assembled device supports Auto Crossover Function. Note also: With loaded EtherCAT Master firmware only the RJ45 channel 0 can be used, channel 1 is deactivated. Beginning with the EtherCAT Master firmware version 3 channel 1 can be reactivated if redundancy is activated. For Open Modbus/TCP with V2.3.4.0 and higher both RJ45 channels can be used.



COM0: Kommunikationsstatus-LED 0 (rot/grün) / Communication Status LED 0 (red/green)

COM1: Kommunikationsstatus-LED 1 (rot/grün) / Communication Status LED 1 (red/green)

Figure 34: Front Side and LED Display Ethernet Assembly Interface (AIFX-RE)



The meaning of the LEDs **COM0** and **COM1** at the reverse side of the AIFX-RE and the meaning of the green and yellow LEDs at RJ45Ch0 and RJ45Ch1 corresponds to the description in chapter *LED Descriptions* beginning from page 94.



### 5.4.2 PROFIBUS - AIFX-DP

Only for CIFX 90-DP\F, CIFX 90E-DP\F, CIFX 90E-DP\ET\F,  
 CIFX 90E-DP\MR\F, CIFX 90E-DP\MR\ET\F,  
 CIFX 104C-DP\F, CIFX 104C-DP\R\F.

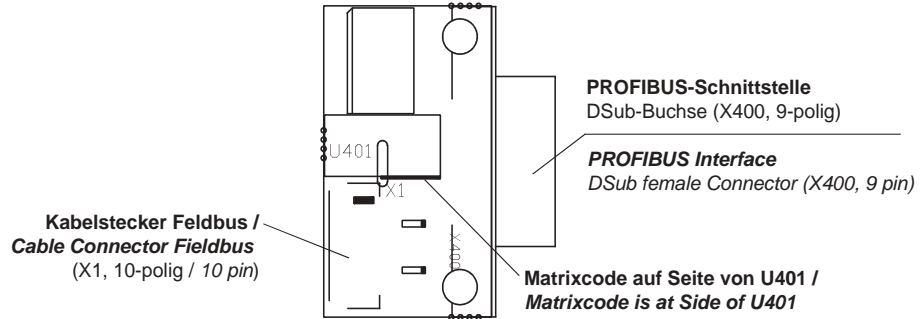

Figure 35: PROFIBUS Assembly Interface (AIFX-DP)

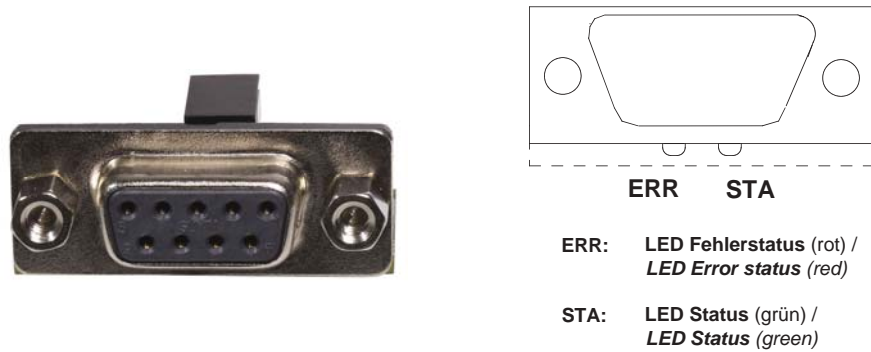

Figure 36: Front Side and LED Display PROFIBUS Assembly Interface (AIFX-DP)



The meaning of the **LEDs ERR** and **STA** at the reverse side of the AIFX-DP corresponds to the description in chapter *LED Descriptions* beginning from page 94.

### 5.4.3 CANopen - AIFX-CO

Only for CIFX 90-CO\F, CIFX 90E-CO\F, CIFX 90E-CO\ET\F, CIFX 90E-CO\MR\F, CIFX 90E-CO\MR\ET\F, CIFX 104C-CO\F, CIFX 104C-CO-R\F.

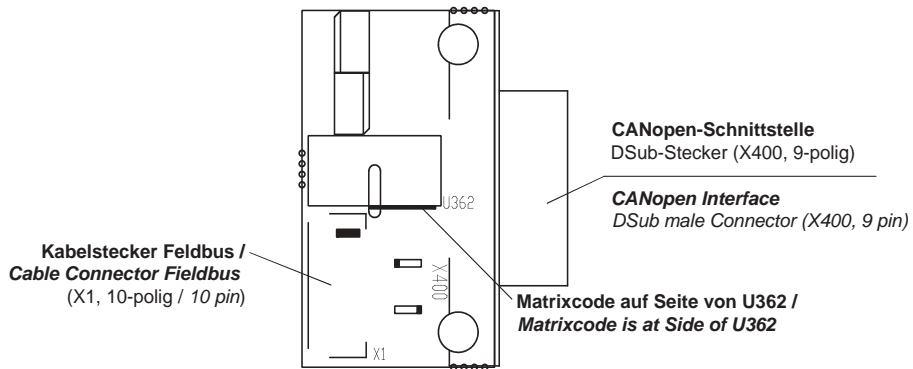

Figure 37: CANopen Assembly Interface (AIFX-CO)

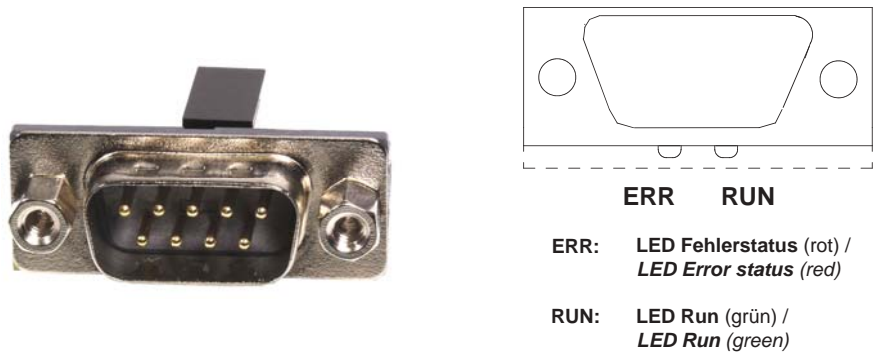

Figure 38: Front Side and LED Display Assembly Interface (AIFX-CO)



The meaning of the **LEDs ERR** and **RUN** at the reverse side of the AIFX-CO corresponds to the description in chapter *LED Descriptions* beginning from page 94.

### 5.4.4 DeviceNet - AIFX-DN

Only for CIFX 90-DN\F, CIFX 90E-DN\F, CIFX 90E-DN\ET\F,  
 CIFX 90E-DN\MR\F, CIFX 90E-DN\MR\ET\F,  
 CIFX 104C-DN\F, CIFX 104C-DN-R\F.

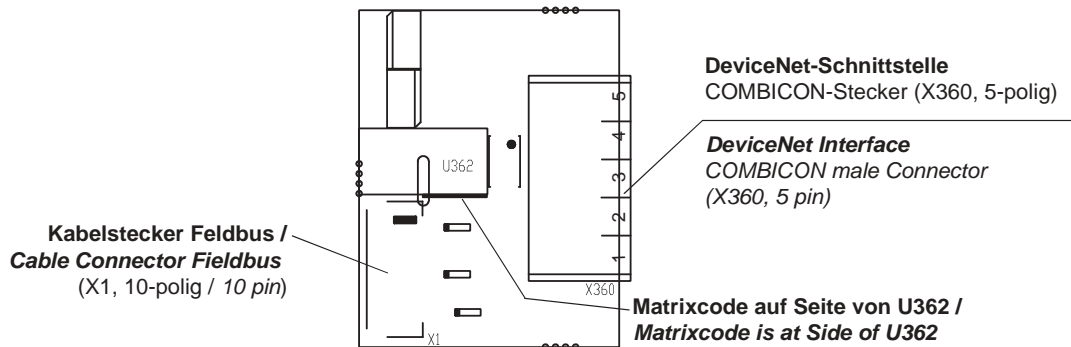

Figure 39: DeviceNet Assembly Interface (AIFX-DN)

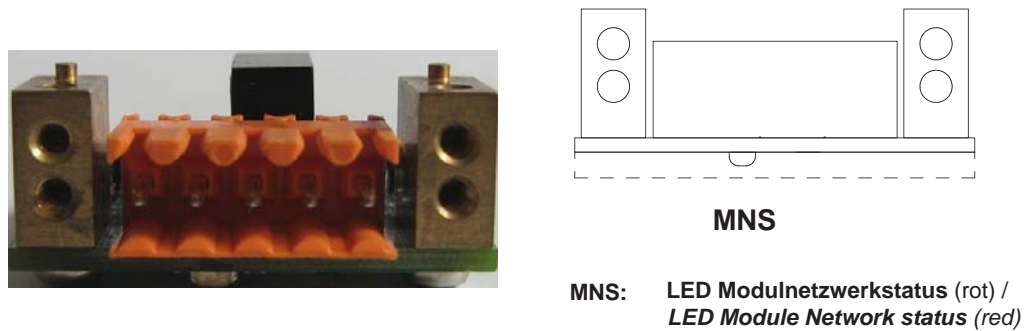

Figure 40: Front Side and LED Display DeviceNet Assembly Interface (AIFX-DN)



The meaning of the **LED MNS** at the reverse side of the AIFX-DN corresponds to the description in chapter *LED Descriptions* beginning from page 94.

### 5.4.5 CC-Link - AIFX-CC

Only for CIFX 90-CC\F, CIFX 90E-CC\ET\F, CIFX 90E-CC\MR\ET\F and CIFX 104C-CC\F.

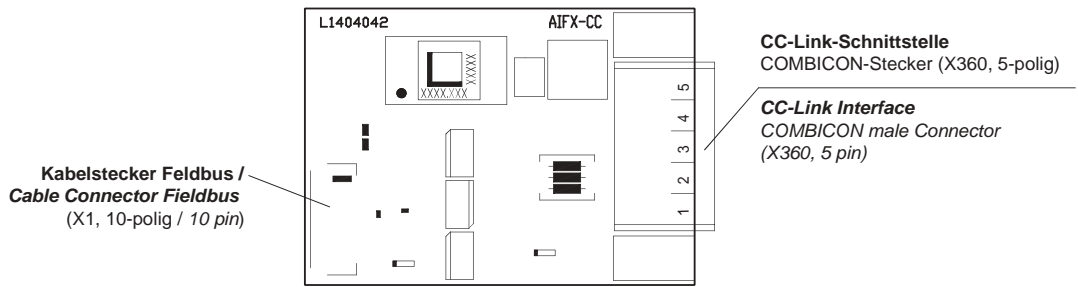

Figure 41: CC-Link Assembly Interface (AIFX-CC)

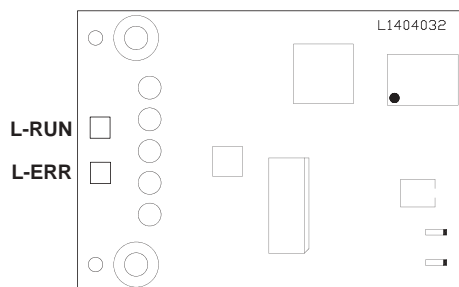

Figure 42: Reverse Side CC-Link Assembly Interface (AIFX-CC) with Matrix Label

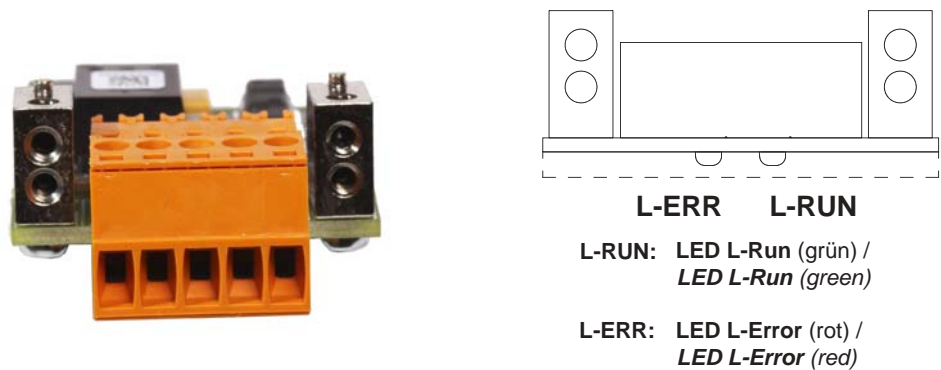

Figure 43: Front Side and LED Display CC-Link Assembly Interface (AIFX-CC)



The meaning of the **LEDs L-RUN** and **L-ERR** at the reverse side of the AIFX-CC corresponds to the description in chapter *LED Descriptions* beginning from page 94.

### 5.4.6 Diagnostic - AIFX-DIAG

Only for CIFX 104C-RE\F, CIFX 104C-RE-R\F, CIFX 104C-DP\F, CIFX 104C-DP-R\F, CIFX 104C-CO\F, CIFX 104C-CO-R\F, CIFX 104C-DN\F, CIFX 104C-DN-R\F and CIFX 104C-CC\F.

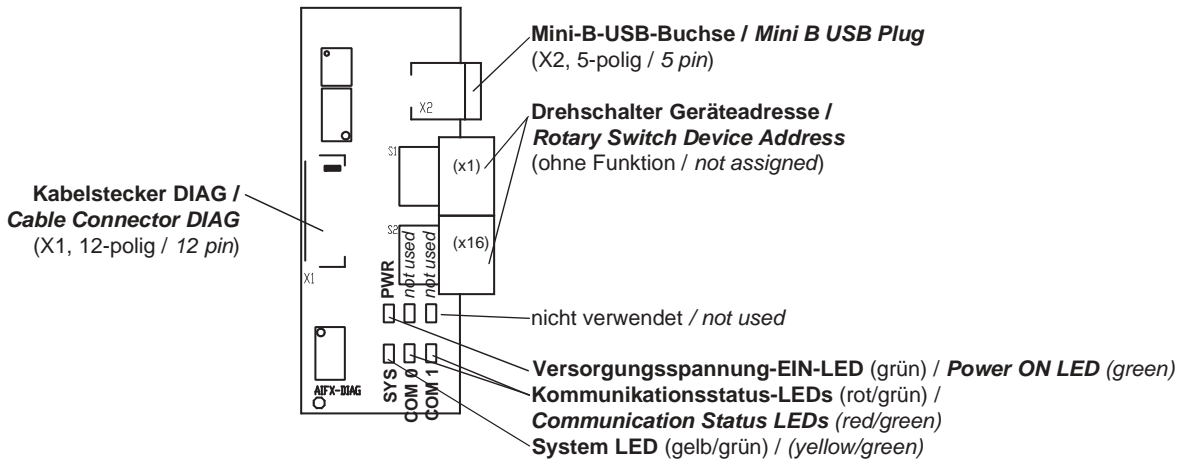
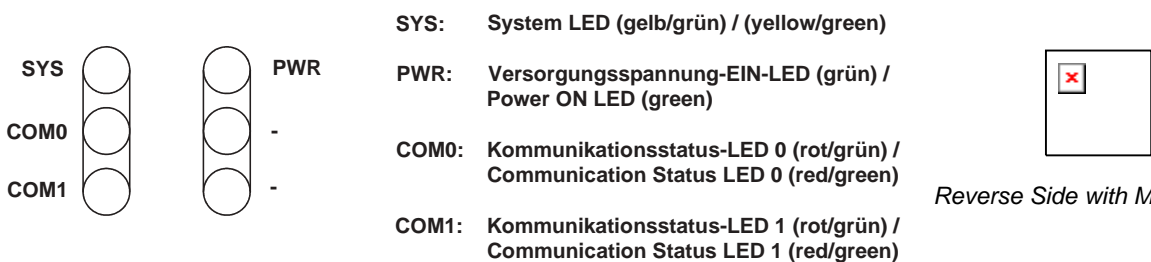
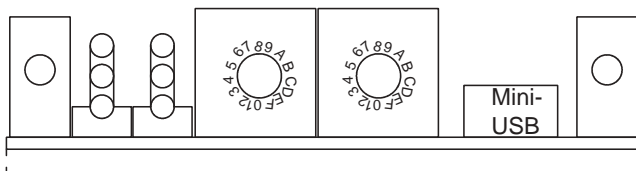
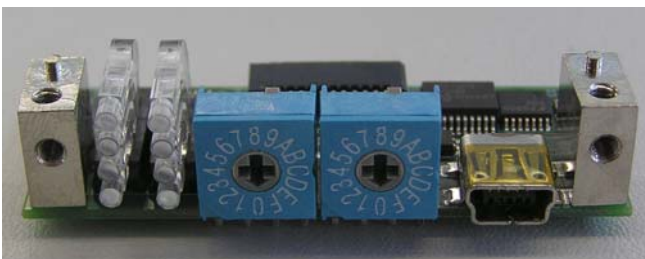

Figure 44: Diagnostic Assembly Interface (AIFX-DIAG)



The meaning of the **LEDs** at the **AIFX-DAIG** corresponds to the descriptions in chapter **LED Descriptions** beginning from page 94. For further information on the **Mini-B USB Connector** refer to section **Mini-B USB Connector (5 Pin)** on page 127.



Reverse Side with Matrix Label

Figure 45: Front Side, LED Display and Reverse Side Diagnostic Assembly Interface (AIFX-DIAG)

## 6 Hardware Installation and Uninstalling

To install / uninstall the PC cards cifX **Compact PCI**

- CIFX 80-RE
- CIFX 80-DP
- CIFX 80-CO
- CIFX 80-DN

### Mini PCI

- CIFX 90-RE\F
- CIFX 90-DP\F
- CIFX 90-CO\F
- CIFX 90-DN\F
- CIFX 90-CC\F

### Mini PCI Express

- CIFX 90E-RE\F
- CIFX 90E-DP\F
- CIFX 90E-CO\F
- CIFX 90E-DN\F
- CIFX 90E-RE\MR\F
- CIFX 90E-DP\MR\F
- CIFX 90E-CO\MR\F
- CIFX 90E-DN\MR\F
- CIFX 90E-RE\ET\F
- CIFX 90E-DP\ET\F
- CIFX 90E-CO\ET\F
- CIFX 90E-DN\ET\F
- CIFX 90E-CC\ET\F
- CIFX 90E-RE\MR\ET\F
- CIFX 90E-DP\MR\ET\F
- CIFX 90E-CO\MR\ET\F
- CIFX 90E-DN\MR\ET\F
- CIFX 90E-2DP\ET\F
- CIFX 90E-2DP\CO\ET\F
- CIFX 90E-2DP\DN\ET\F
- CIFX 90E-2CO\ET\F
- CIFX 90E-2CO\DN\ET\F
- CIFX 90E-2DN\ET\F
- CIFX 90E-2DP\MR\ET\F
- CIFX 90E-2DP\CO\MR\ET\F
- CIFX 90E-2DP\DN\MR\ET\F
- CIFX 90E-2CO\MR\ET\F
- CIFX 90E-2CO\DN\MR\ET\F
- CIFX 90E-2DN\MR\ET\F

and **PCI-104**

- CIFX 104C-RE
- CIFX 104C-RE-R
- CIFX 104C-RE\F
- CIFX 104C-RE-R\F
- CIFX 104C-DP
- CIFX 104C-DP-R
- CIFX 104C-DP\F
- CIFX 104C-DP-R\F
- CIFX 104C-CO
- CIFX 104C-CO-R
- CIFX 104C-CO\F
- CIFX 104C-CO-R\F
- CIFX 104C-DN
- CIFX 104C-DN-R
- CIFX 104C-DN\F
- CIFX 104C-DN-R\F
- CIFX 104C-CC\F

handle as described in the sections hereafter. The device drawing of your PC card cifX gives information on the manual control elements of your device.



For the installation, uninstalling and replacement of the PC card cifX check any notes in the overview in chapter *Getting Started* on page 50.

## 6.1 Safety Messages on Personal Injury

Obey to the following safety messages on personal injury, when installing, uninstalling or replacing the PC card cifX.

### 6.1.1 Electrical Shock Hazard



**WARNING**

#### **Lethal Electrical Shock caused by parts with more than 50V!**



- HAZARDOUS VOLTAGE inside of the PC or of the connecting device.
- Strictly obey to all safety rules provided by the device's manufacturer in the documentation!
- First disconnect the power plug of the PC or of the connecting device, before you open the cabinet.
- Make sure, that the power supply is off at the PC or at the connecting device.
- Open the PC cabinet and install or remove the PC card cifX only after disconnecting power.

## 6.2 Property Damage Messages

Obey to the following property damage messages, when installing, uninstalling or replacing the PC card cifX.

### 6.2.1 Device Destruction by exceeding allowed Supply Voltage

Adhere for all PC cards cifX described in this manual the instruction hereafter:

---

**NOTICE****Device Destruction!**

- Use only the permissible supply voltage to operate the PC card cifX.
  - Operating the PC card cifX with a supply voltage above of the specified range leads to device destruction.
- 

### 6.2.2 Device Destruction by exceeding allowed Signaling Voltage

Adhere for all PC cards cifX described in this manual the instruction hereafter:

---

**NOTICE****Device Destruction!**

- All I/O signal pins at the PC card cifX tolerate only a specified signaling voltage!
  - Operation the PC card cifX with a signaling voltage other than the specified signaling voltage may lead to severe damage to the PC card cifX!
- 

For detailed information on the supply and signaling voltage of the PC cards cifX described in this manual, refer to section *Power Supply and Host Interface* on page 46.

### 6.2.3 Electrostatically sensitive Devices

Adhere to the necessary safety precautions for components that are vulnerable with electrostatic discharge.



---

**NOTICE****Electrostatically sensitive Devices**

- To prevent damage to the PC and the PC card cifX, make sure, that the PC card cifX is grounded via the endplate and the PC and make sure, that you are discharged when you install/uninstall the PC card cifX.
-



### 6.3 Fix Front Plate Sticker at CIFX 80-RE



**Note:** Your PC card CIFX 80-RE set contains a set of front plate stickers (9 different stickers). Depending from the loaded firmware the label on each sticker indicates for the respective system the following **LED names**:

- of the **system and communication status LEDs** (*above*)
- of the **RJ45 Ethernet female connector LEDs** (*below*).

Further information to this question you find also in chapter *LED Descriptions* beginning from page 94.

**NOTICE**

**Electrostatically sensitive Devices**

- To prevent damage to the PC and the PC card cifX, make sure, that the PC card cifX is grounded via the endplate and the PC and make sure, that you are discharged when you install/uninstall the PC card cifX.
- Use the sticker according to the firmware and glue it on the front of the PC card CIFX 80-RE.

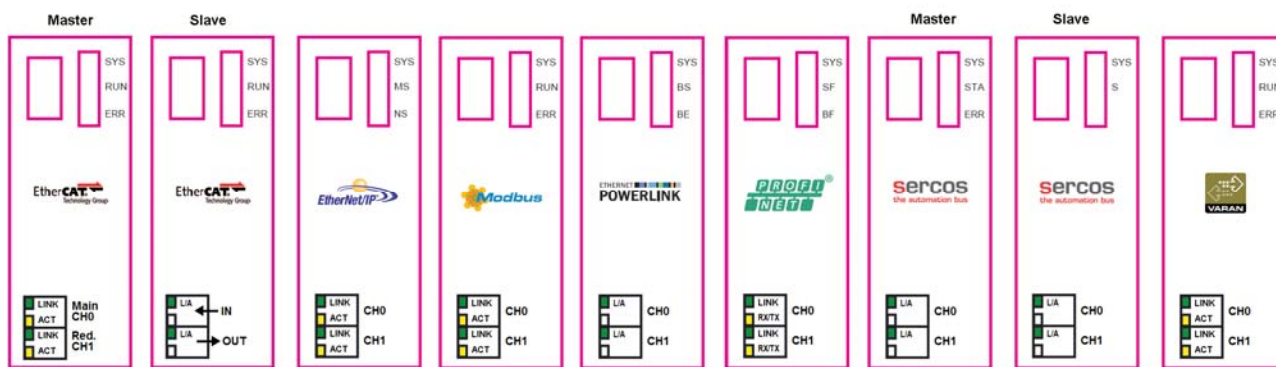

Figure 46: Front Plate Stickers for CIFX 80-RE

LED		EtherCAT Master	EtherCAT Slave	EtherNet/IP	Open Modbus/TCP	POWERLINK	PROFINET IO	sercos Master	sercos Slave	VARAN
SYS (yellow/green)		SYS	SYS	SYS	SYS	SYS	SYS	SYS	SYS	SYS
COM 0 (red/ green)		RUN	RUN	MS	RUN	BS	SF	STA	S	RUN
COM 1 (red/ green)		ERR	ERR	NS	ERR	BE	BF	ERR	-	ERR
RJ45 Ch0	green	LINK	L/A IN	LINK	LINK	L/A	LINK	L/A	L/A	LINK
	yellow	ACT	-	ACT	ACT	-	RX/TX	-	-	ACT
RJ45 Ch1	green	LINK	L/A OUT	LINK	LINK	L/A	LINK	L/A	L/A	LINK
	yellow	ACT	-	ACT	ACT	-	RX/TX	-	-	ACT

Table 37: LED Labeling depending of the loaded Firmware

## 6.4 Installing PC Cards cifX Compact PCI

1. Adhere to the necessary safety precautions for components that are vulnerable with electrostatic discharge.

### NOTICE

#### Electrostatically sensitive Devices

- To prevent damage to the PC and the PC card cifX, make sure, that the PC card cifX is grounded via the endplate and the PC and make sure, that you are discharged when you install/uninstall the PC card cifX.
2. Fix front plate sticker (only for CIFX 80-RE).
    - Use the sticker according to the firmware and glue it on the front of the PC card CIFX 80-RE (see section *Fix Front Plate Sticker at CIFX 80-RE* on page 81).
  3. Take safety precautions.

### WARNING

#### Lethal Electrical Shock caused by parts with more than 50V!

- Disconnect the power plug of the PC or of the connecting device.
  - Make sure, that the power supply is off at the PC or at the connecting device.
4. Open cabinet.
    - Open the cabinet of the PC or of the connecting device.
  5. Install PC card cifX **Compact PCI**.
    - Possibly remove a blank plate.
    - Put down the ejection lever at the PC card cifX.
    - Plug the PC card cifX into a free Compact PCI slot.
    - Fasten the PC card cifX.
    - Tip up the lever and click in.
    - Screw the PC card cifX with two screws on the wholes above and below.

After this:

6. Close cabinet.
  - Close the cabinet of the PC or connecting device.
7. Plug the connecting cable to the Master or Slave.
  - For the PC cards CIFX 80-RE note:



**Note:** The RJ45 socket is only for use in LAN, not for telecommunication circuits. For further information refer to section *Ethernet Interface* on page 123.

- Plug the connecting cable from the PC card cifX to the PC card Master or Slave.
8. Connect the PC or the connecting device to the power supply and switch it on.

- Connect the PC or the connecting device to the power supply.
- Switch on the PC or the connecting device.

## 6.5 Uninstalling PC Cards cifX Compact PCI

1. Take safety precautions.

### WARNING

#### **Lethal Electrical Shock caused by parts with more than 50V!**

- Disconnect the power plug of the PC or of the connecting device.
- Make sure, that the power supply is off at the PC or at the connecting device.

### NOTICE

#### **Electrostatically sensitive Devices**

- To prevent damage to the PC and the PC card cifX, make sure, that the PC card cifX is grounded via the endplate and the PC and make sure, that you are discharged when you install/uninstall the PC card cifX.
2. Remove the connecting cable to the Master or Slave.
    - Remove the connecting cable between the PC card cifX and the PC card Master or Slave.
  3. Open cabinet.
    - Open the cabinet of the PC or of the connecting device.
  4. Uninstall PC card cifX **Compact PCI**.
    - Unscrew the PC card cifX.
    - First press the grey button at the ejection lever.
    - Then press the ejection lever downwards.
    - Remove the PC card cifX from the Compact PCI slot.
    - Possibly reinsert a blank plate.

After this:

5. Close cabinet.
  - Close the cabinet of the PC or connecting device.

## 6.6 Installing PC Cards cifX Mini PCI and Mini PCI Express

1. Take safety precautions.

### **WARNING**

#### **Lethal Electrical Shock caused by parts with more than 50V!**

- Disconnect the power plug of the PC or of the connecting device.
- Make sure, that the power supply is off at the PC or at the connecting device.

### **NOTICE**

#### **Electrostatically sensitive Devices**

- To prevent damage to the PC and the PC card cifX, make sure, that the PC card cifX is grounded via the endplate and the PC and make sure, that you are discharged when you install/uninstall the PC card cifX.

2. Open cabinet.

- Open the cabinet of the PC or of the connecting device.

3. Install the basic card of the PC card cifX **Mini PCI**.

- Plug the basic card into the Mini PCI socket on the mainboard until it snaps into place.
- Press the clamps on the sides at the Mini PCI socket until they snap into place, to fasten the basic card to the mainboard.

4. Install the basic card of the PC card cifX **Mini PCI Express**.

- Plug the basic card into the PCI Express Mini System Connector on the mainboard.
- Press down the basic card until it snaps into place.

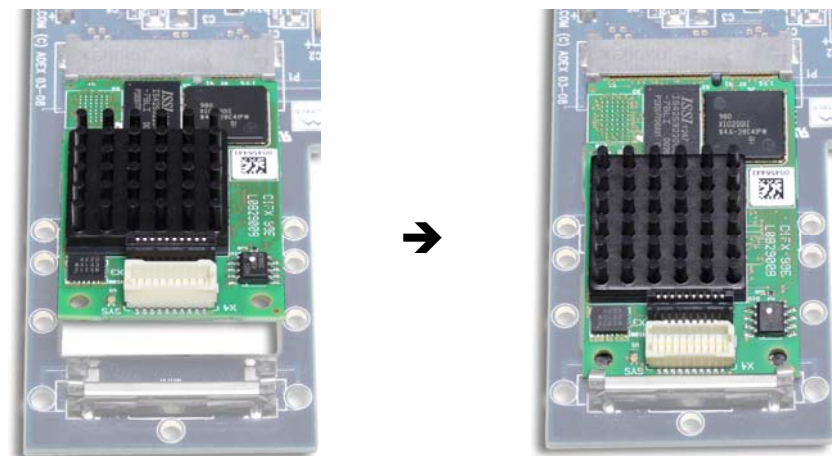

*Plug the basic card into the PCI Express Mini System Connector on the mainboard ...*

*... and press down the card until it snaps into place.*

*Figure 47: Mounting the Basic Card CIFX 90E into the PCI Express Mini System Connector*

**Connect AIFX Assembly Interface**



**Important!** Operating the PC cards **Mini PCI CifX 90-RE\F**, CifX 90-DP\F, CifX 90-CO\F and CifX 90-DN\F or the PC cards **Mini PCI Express CifX 90E-XX\F** (alle variants 'MR' or 'ET')<sup>5</sup> requires proper connection of the Ethernet (AIFX-RE), PROFIBUS (AIFX-DP), CANopen (AIFX-CO), DeviceNet (AIFX-DN) or CC-Link (AIFX-CC) assembly interface to the basic card! For 2-channel devices both assembly interfaces must be connected.

5. Connect the Ethernet assembly interface (AIFX-RE) to the basic card:
  - Connect the **cable connector Ethernet X1** on the AIFX-RE with the cable.
  - Connect the **cable connector Ethernet X4** on the basic card CifX 90 or CifX 90E (all variants 'MR' or 'ET') with the cable.

AIFX-RE Assembly Interface with Cable Connector Ethernet X1

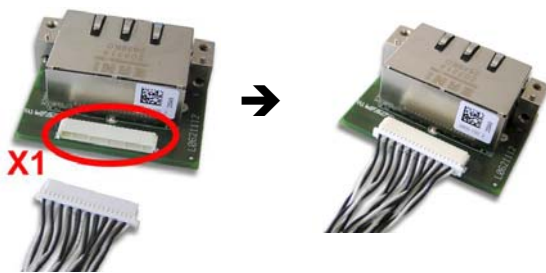

Example CifX 90E-RE\F with Cable Connector Ethernet X4

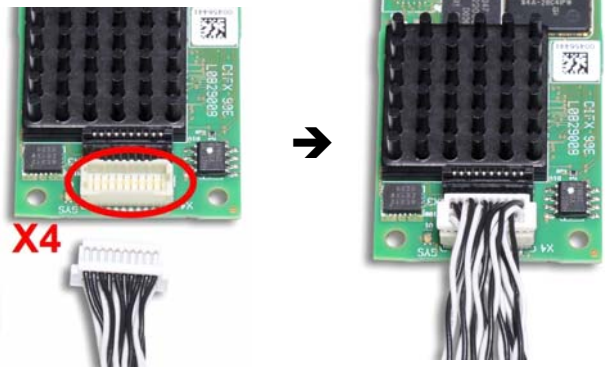
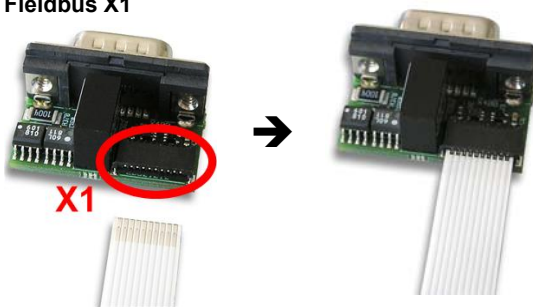

Figure 48: Connecting the Ethernet Assembly Interface (AIFX-RE) to the basic Card CifX 90E (Example)

6. Alternatively connect the fieldbus assembly interface to the basic card:
  - Connect the **cable connector fieldbus X1** on the AIFX-DP, AIFX-CO, AIFX-DN or AIFX-CC assembly interface with the cable.
  - Connect the **cable connector fieldbus X3** on the basic card CifX 90 or CifX 90E (all variants 'MR' or 'ET') with the cable.

AIFX-CO Assembly Interface with Cable Connector Fieldbus X1



Example basic card CifX 90E, Cable Connector Fieldbus X3

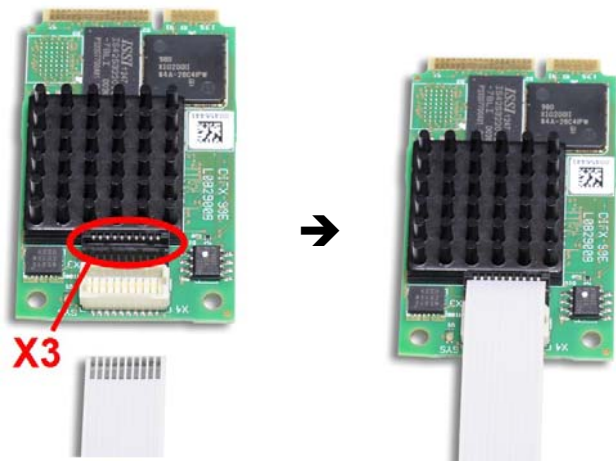

**Important!** The contacts on the connection cable must face up!

Figure 49: Connecting the CANopen Assembly Interface (AIFX-CO) to the basic Card CifX 90E (Example)

<sup>5</sup> Variants of the PC card CifX 90E-XX\F: CifX 90E-XX\ET\F, CifX 90E-XX\MR\F or CifX 90E-XX\MR\ET\F (XX = RE, DP, CO or DN)

7. Connect the fieldbus assembly interface to the basic card for the PC cards cifX with 2 channels:
  - Connect the **cable connector fieldbus X1** on the used AIFX-DP, AIFX-CO or AIFX-DN assembly interface with the cable.
  - Connect the **cable connector fieldbus X3** and the **cable connector fieldbus X4** on the basic card CIFX 90E-2FB\ET or CIFX 90E-2FB\MR\ET with the cable.

Example basic card **CIFX 90E-2FB\ET**, **Cable Connector Fieldbus X3** and **X4**

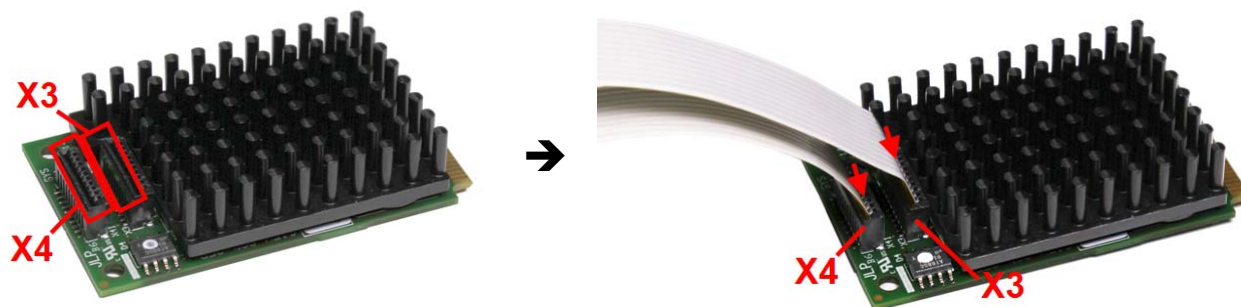

Figure 50: PC Cards cifX Mini PCI Express with 2 Channels: How to connect the Assembly Interfaces to the Basic Card (Example CIFX 90E-2FB\ET)



**Important:** For PC cards cifX Mini PCI Express with two channels and two different fieldbus systems (PROFIBUS/CANopen, PROFIBUS/DeviceNet or CANopen/DeviceNet) the assembly interfaces AIFX-DP, AIFX-CO or AIFX-DN must be connected to the cable connectors fieldbus X3 or X4 as it is listed in the following table.

PC Card cifX	Basic Card	Cable Connector Fieldbus X3	Cable Connector Fieldbus X4
CIFX 90E-2DP\CO\ET\F	CIFX 90E-2FB\ET	AIFX-DP	AIFX-CO
CIFX 90E-2DP\CO\MR\ET\F	CIFX 90E-2FB\MR\ET		
CIFX 90E-2DP\DN\ET\F	CIFX 90E-2FB\ET	AIFX-DP	AIFX-DN
CIFX 90E-2DP\DN\MR\ET\F	CIFX 90E-2FB\MR\ET		
CIFX 90E-2CO\DN\ET\F	CIFX 90E-2FB\ET	AIFX-CO	AIFX-DN
CIFX 90E-2CO\DN\MR\ET\F	CIFX 90E-2FB\MR\ET		

Table 38: How to assign the Assembly Interfaces for 2-Channel Cards cifX Mini PCI Express

8. Mount the assembly interfaces at the housing panel of the PC.
  - Install the used AIFX-RE, AIFX-DP, AIFX-CO, AIFX-DN or AIFX-CC assembly interfaces at the housing panel.

After this:

9. Close cabinet.
  - Close the cabinet of the PC or connecting device.
10. Plug the connecting cable to the Master or Slave.
  - For the PC cards CIFX 90-RE\F or CIFX 90E-RE\F (all variants) note:



**Note:** The RJ45 socket is only for use in LAN, not for telecommunication circuits. For further information refer to section *Ethernet Interface* on page 123.

- Plug the connecting cable from the PC card cifX to the PC card Master or Slave.

11. Connect the PC or the connecting device to the power supply and switch it on.
  - Connect the PC or the connecting device to the power supply.
  - Switch on the PC or the connecting device.

## 6.7 Uninstalling PC Cards cifX Mini PCI, Mini PCI Express

1. Take safety precautions.

### **WARNING**

#### **Lethal Electrical Shock caused by parts with more than 50V!**

- Disconnect the power plug of the PC or of the connecting device.
- Make sure, that the power supply is off at the PC or at the connecting device.

### **NOTICE**

#### **Electrostatically sensitive Devices**

- To prevent damage to the PC and the PC card cifX, make sure, that the PC card cifX is grounded via the endplate and the PC and make sure, that you are discharged when you install/uninstall the PC card cifX.
2. Remove the connecting cable to the Master or Slave.
    - Remove the connecting cable between the PC card cifX to be replaced and the PC card Master or Slave.
  3. Open cabinet.
    - Open the cabinet of the PC or of the connecting device.

#### **Uninstall AIFX Assembly Interface**

4. Uninstall the Ethernet (AIFX-RE), PROFIBUS (AIFX-DP), CANopen (AIFX-CO), DeviceNet (AIFX-DN) or CC-Link (AIFX-CC) assembly interface:
  - Remove the AIFX-RE, AIFX-DP, AIFX-CO, AIFX-DN or AIFX-CC assembly interface from the housing panel of the PC.
  - Disconnect the cable from the basic card of the PC card cifX Mini PCI or Mini PCI Express; cable connector Ethernet X4 or cable connector fieldbus X3.

#### **Remove PC Card cifX**

5. Remove the basic card of the PC card cifX **Mini PCI**:
  - To remove the PC card cifX from the mainboard, pull the clamps on the sides at the Mini PCI socket on the mainboard until the basic card flips up.
  - Remove the basic card from the Mini PCI socket.

Or:

6. Remove the basic card of the PC card cifX **Mini PCI Express**:

- Press down the fastening clips (on the upper edge of the PC card cifX), until the basic card flips up.

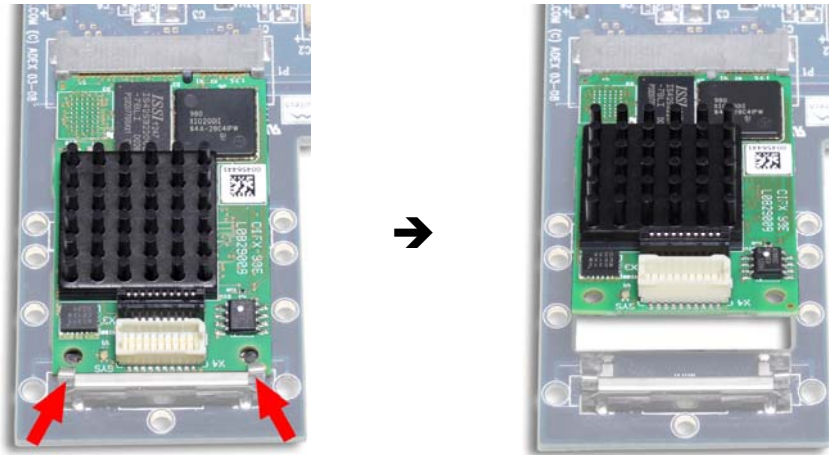

*Press down the fastening clips (red arrows) of ... until the card flips up. the basic card ...*

*Figure 51: Demounting the Basic Card CIFX 90E<sup>6</sup> from the PCI Express Mini System Connector (Example: Basic Card CIFX 90E)*

- Remove the PC card cifX from the PCI Express Mini System Connector.

After this:

7. Close cabinet.
- Close the cabinet of the PC or connecting device.

<sup>6</sup> all variants: CIFX 90E, CIFX 90E\ET, CIFX 90E\MR, CIFX 90E\MR\ET



## 6.8 Installing PC Cards cifX PCI-104 (PCI-104-Modules)



**Note:** For PC cards cifX PCI-104 with AIFX assembly interface first install the basic card. Then connect the AIFX assembly interface to the basic card.

1. Adhere to the necessary safety precautions for components that are vulnerable with electrostatic discharge.

### NOTICE

#### Electrostatically sensitive Devices

- To prevent damage to the PC and the PC card cifX, make sure, that the PC card cifX is grounded via the endplate and the PC and make sure, that you are discharged when you install/uninstall the PC card cifX.
2. Set the physical PCI-104 Slot Number.
    - Set the physical PCI-104 Slot Number for each PCI-104 module. For the PC cards cifX PCI-104 use the **Rotary Switch for PCI-104 Slot Number** on the PC card cifX.



**Note:** At maximum four PCI-104 modules can be plugged one upon the other and each switch position may only be used once. The PCI-104 module plugged next to the host controller gets the CLK number 0, the following PCI-104 modules respectively get the next higher CLK number. For further information refer to section *Rotary Switch for PCI-104 Slot Number* on page 127.

3. Take safety precautions.

### ⚠ WARNING

#### Lethal Electrical Shock caused by parts with more than 50V!

- Disconnect the power plug of the PC or of the connecting device.
  - Make sure, that the power supply is off at the PC or at the connecting device.
4. Open cabinet.
    - Open the cabinet of the PC or of the connecting device.



**Note:** If several PCI-104 modules shall be put together in a stack:

- (a) Install the first PCI-104 module on the mainboard.
- (b) Only for the basic cards CIFX 104C-RE\F and CIFX 104C-RE-R\F or the basic cards CIFX 104C-FB\F and CIFX 104C-FB-R\F: Connect the AIFX-RE, AIFX-DP, AIFX-CO, AIFX-DN, AIFX-CC assembly interface and respectively AIFX-DIAG to the basic card for the first PCI-104 module.
- (c) Connect any other PCI-104 module on the respective underlying PCI-104 module.

5. Install PC card cifX **PCI-104**.

- Plug the PC card cifX into a free PCI-104 slot (or if so, to the underlying PCI-104 module).
- Fix the PC card cifX using 4 spacing bolts and screws intended to the mainboard (or if so, to the underlying PCI-104 module). The scope of delivery does not include spacing bolts and screws.

**Connect AIFX Assembly Interface**

Only for the basic cards for CIFX 104C-RE\F and CIFX 104C-RE-R\F or the basic cards CIFX 104C-FB\F and CIFX 104C-FB-R\F:



**Note:** First connect the AIFX-RE, AIFX-DP, AIFX-CO, AIFX-DN or AIFX-CC assembly interface to each basic card PCI-104, before plugging another PCI-104 module. Just so you can check exactly whether the AIFX is properly connected to the basic card.



**Important!** Operating the PC cards CIFX 104C-XX\F or CIFX 104C-XX-R\F requires proper connection of the Ethernet (AIFX-RE), PROFIBUS (AIFX-DP), CANopen (AIFX-CO), DeviceNet (AIFX-DN) or CC-Link (AIFX-CC) assembly interface to the basic card!

6. Connect the Ethernet assembly interface (AIFX-RE) to the basic card.
  - Connect the **cable connector Ethernet X1** on the AIFX-RE with the cable.
  - Connect the **cable connector Ethernet X4** (or X304) on the basic card CIFX 104C-RE\F or CIFX 104C-RE-R\F with the cable.

AIFX-RE Assembly Interface with Cable Connector Ethernet X1

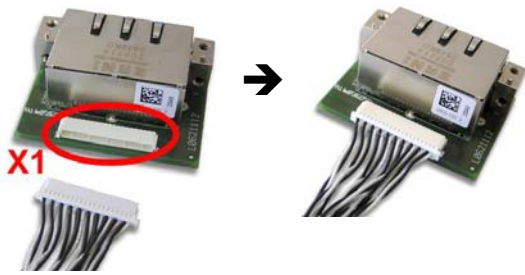

Example CIFX 104C-RE\F with Cable Connector Ethernet X4

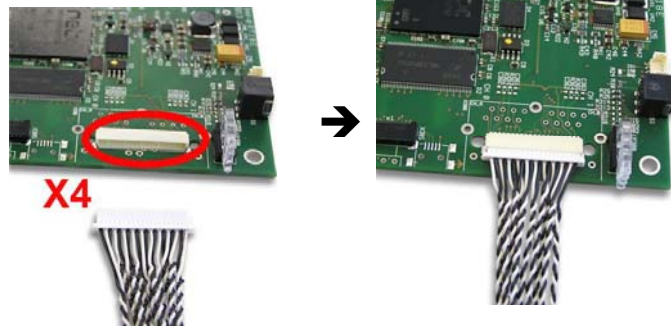
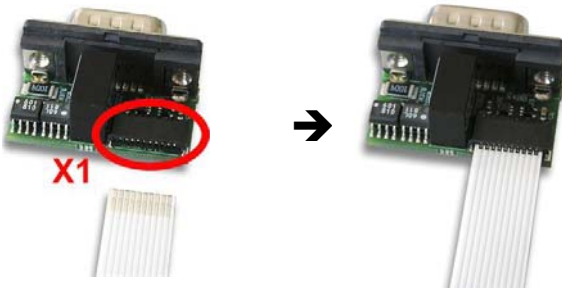

Figure 52: Connecting the Ethernet Assembly Interface (AIFX-RE) to the Basic Card CIFX 104C-RE\F (Example)

7. Or connect the PROFIBUS (AIFX-DP), CANopen (AIFX-CO), DeviceNet (AIFX-DN) or CC-Link (AIFX-CC) assembly interface to the basic card.
  - Connect the **cable connector fieldbus X1** on the assembly interface with the cable.
  - Connect the **cable connector fieldbus X4** (or X304) on the PC card CIFX 104C-FB\F or CIFX 104C-FB-R\F Fieldbus with the cable.

AIFX-CO Assembly Interface with Cable Connector Fieldbus X1



Example basic card CIFX 104C-CO-R\F, Cable Connector Fieldbus X4

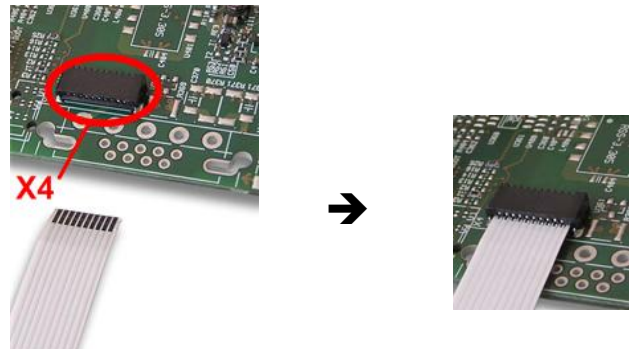

**Important!** The contacts on the connection cable must face up!

Figure 53: Connecting the CANopen Assembly Interface (AIFX-CO) to the Basic Card 104C-FB-R\F (Example)

- Install the AIFX-RE, AIFX-DP, AIFX-CO, AIFX-DN or AIFX-CC assembly interface at the front plate of the PC cabinet.

### **Connect AIFX-DIAG**

Only for the basic cards for CIFX 104C-RE\F and CIFX 104C-RE-R\F or the basic cards CIFX 104C-FB\F and CIFX 104C-FB-R\F:

8. If so, connect the diagnostic assembly interface (AIFX-DIAG):
  - Connect the **cable connector DIAG X1** on the diagnostic assembly interface (AIFX-DIAG) with the cable.
  - Connect the **cable connector DIAG X3** (or X303) on the PC card cifX with the cable.
  - Install the assembly interface AIFX-DIAG at the front plate of the PC cabinet.

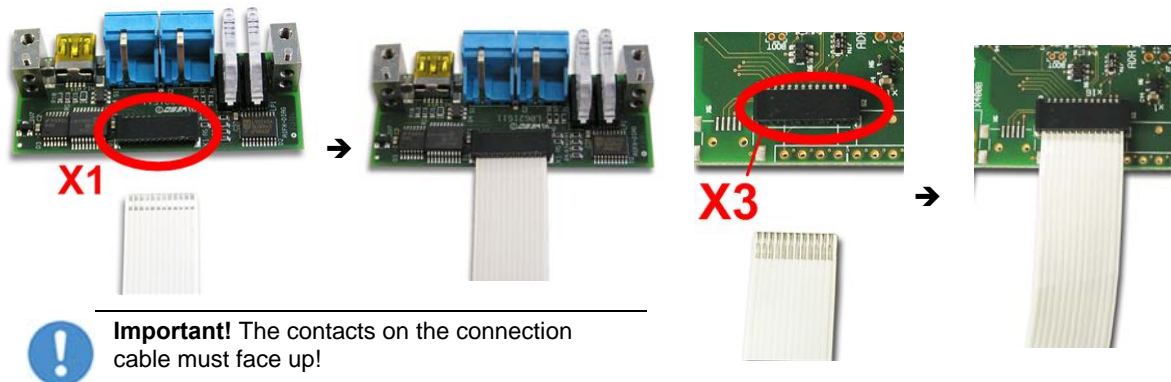

Figure 54: Connecting the Diagnostic Assembly Interface (AIFX-DIAG) to the Basic Card CIFX 104C-FB-R\F (Example)

After this:

9. Close cabinet.
  - Close the cabinet of the PC or connecting device.
10. Plug the connecting cable to the Master or Slave.
  - For the PC cards CIFX 104C-RE\F or CIFX 104C-RE-R\F note:



**Note:** The RJ45 socket is only for use in LAN, not for telecommunication circuits. For further information refer to section *Ethernet Interface* on page 123.

- Plug the connecting cable from the PC card cifX to the PC card Master or Slave.
11. Connect the PC or the connecting device to the power supply and switch it on.
    - Connect the PC or the connecting device to the power supply.
    - Switch on the PC or the connecting device.

## 6.9 Uninstalling PC Cards cifX PCI-104

1. Take safety precautions.

### WARNING

#### **Lethal Electrical Shock caused by parts with more than 50V!**

- Disconnect the power plug of the PC or of the connecting device.
- Make sure, that the power supply is off at the PC or at the connecting device.

### NOTICE

#### **Electrostatically sensitive Devices**

- To prevent damage to the PC and the PC card cifX, make sure, that the PC card cifX is grounded via the endplate and the PC and make sure, that you are discharged when you install/uninstall the PC card cifX.
2. Remove the connecting cable to the Master or Slave.
    - Remove the connecting cable between the PC card cifX to be replaced and the PC card Master or Slave.
  3. Open cabinet.
    - Open the cabinet of the PC or of the connecting device.



**Note:** If a PC card CIFX 104C-XX\F or CIFX 104C-XX-R\F shall be uninstalled from a stack of PCI-104 modules:

- (a) Remove all PCI-104 modules above from the PC card cifX and the PC card cifX. For each PC card cifX first remove the AIFX assembly interfaces from the basic cards.
- (b) Reinstall the removed PCI-104 modules.

### **Uninstall AIFX Assembly Interfaces**

Only for PC cards PCI-104 with AIFX Assembly Interface CIFX 104C-XX\F and CIFX 104C-XX-R\F:

4. Uninstall the AIFX assembly interface:
  - Remove the assembly interfaces Ethernet (AIFX-RE), PROFIBUS (AIFX-DP), CANopen (AIFX-CO), DeviceNet (AIFX-DN), CC-Link (AIFX) and diagnostic (AIFX-DIAG) from the front plate of the PC cabinet.
  - Disconnect the cables from the PC card cifX PCI-104; cable connector Ethernet X4 (or X304) or cable connector fieldbus X4 (or X304) and cable connector DIAG X3 (or X303).

### **Remove PC Card cifX**

5. Remove PC card cifX **PCI-104**.
  - Loosen the four fastening screws of the PC card cifX.
  - Remove the PC card cifX.

After this:

6. Close cabinet.
  - Close the cabinet of the PC or connecting device.

## 7 Troubleshooting

### 7.1 Instructions for Problem Solving

In case of any error, follow the instructions for problem solving given here:

#### **General**

- Check the PC card cifX operating requirements according to the requirements given in the section *Requirements for Operation of the PC Cards cifX* on page 48.

#### **SYS and COM Status LEDs**

Troubleshooting of the system is done by examining the LEDs behaviour. The PC cards cifX have depending by card type two or three bicolor status LEDs, which inform the user about the communication state of the device.

- The **SYS** LED shows the common system status of the device. It can be yellow or green ON or it can blink green/yellow.
- The **COM** LEDs display the status of the Real-Time Ethernet or fieldbus communication. Depending by protocol and state, the LEDs can be ON or flash cyclic or acyclic in green or red (or orange).

If the LED SYS is solid green and the LED COM or COM0 is static green, the PC card cifX is in operational state, the Master is in data exchange with the connected Slaves and the communication is running without fault. The meaning of the LEDs is described in chapter *LED Descriptions* beginning from page 94.

#### **LINK-LED** (for PC cards cifX Real-Time Ethernet)

- Check using the LINK LED's status whether a connection to the Ethernet is established. Therefore use the description on the LINK LED in the chapter *LED Descriptions* beginning from page 94.

#### **Cable**

- Check that the pin assignment of the cable is correct. This means, the cable by which you connect the PC card cifX to the PC card Master or Slave.

#### **Configuration**

- Check the configuration in the Master device and the Slave device. The configuration has to match.

#### **Diagnosis**

Via **Online > Diagnosis** (for SYCON.net) or **netX Configuration Tool > Diagnostics** (for netX Configuration Tool) the diagnostic information of the device is shown. The shown diagnostic information depends on the used protocol.



Further information about the device diagnosis and its functions you find in the operating instruction manual of the corresponding Real-Time Ethernet or fieldbus system.

## 8 LED Descriptions

The LEDs will be used to indicate status information of the PC card cifX. Each LED has a specific function during Run, configuration download and error indications. The descriptions hereafter show the reaction of each LED for the PC card cifX during these states.

### 8.1 Overview LEDs Real-Time Ethernet Systems



**Note:** The meaning of the communication status LEDs and of the Ethernet LEDs at the device is defined by the loaded firmware of the protocol.

LED Naming in the Device Drawing		EtherCAT Master	EtherCAT Slave	EtherNet/IP	Open-Modbus/TCP	POWERLINK	PROFINET IO	sercos Master	sercos Slave	VARAN
<b>SYS</b> (System Status) ● (yellow) ● (green) (yellow/green)		<b>SYS</b>	<b>SYS</b>	<b>SYS</b>	<b>SYS</b>	<b>SYS</b>	<b>SYS</b>	<b>SYS</b>	<b>SYS</b>	<b>SYS</b>
<b>COM 0</b> (Communication Status)		<b>RUN</b> ● (green)	<b>RUN</b> ● (green)	<b>MS</b> ● (red) ● (green) (red/green)	<b>RUN</b> ● (green)	<b>BS</b> ● (green)	<b>SF</b> ● (red) (red)	<b>STA</b> ● (green)	<b>S</b> ● (red) ● (green) ● (orange) (red/green/orange)	<b>RUN</b> ● (green)
<b>COM 1</b> (Communication Status)		<b>ERR</b> ● (red)	<b>ERR</b> ● (red)	<b>NS</b> ● (red) ● (green) (red/green)	<b>ERR</b> ● (red)	<b>BE</b> ● (red)	<b>BF</b> ● (red)	<b>ERR</b> ● (red)	-	<b>ERR</b> ● (red)
Ethernet Ch0	● (green)	<b>LINK</b>	<b>L/A IN</b>	<b>LINK</b>	<b>LINK</b>	<b>L/A</b>	<b>LINK</b>	<b>L/A</b>	<b>L/A</b>	<b>LINK</b>
	● (yellow)	<b>ACT</b>	-	<b>ACT</b>	<b>ACT</b>	-	<b>RX/TX</b>	-	-	<b>ACT</b>
Ethernet Ch1	● (green)	-	<b>L/A OUT</b>	<b>LINK</b>	<b>LINK</b>	<b>L/A</b>	<b>LINK</b>	<b>L/A</b>	<b>L/A</b>	<b>LINK</b>
	● (yellow)	-	-	<b>ACT</b>	<b>ACT</b>	-	<b>RX/TX</b>	-	-	<b>ACT</b>

Table 39: Overview LEDs Real-Time Ethernet Systems

LED	Name	Meaning
System Status	SYS	System Status
Communication Status	COM	Communication Status
	RUN	Run
	ERR	Error
	STA	Status
	MS	Module Status
	NS	Network Status
	BS	Bus Status
	BE	Bus Error
	SF	System Failure
	BF	Bus Failure
	S	Status / Error

Table 40: LED Names

LED	Name	Meaning
Ethernet	LINK, L	Link
	ACT, A	Activity
	L/A	Link/Activity
	L/A IN	Link/Activity Input
	L/A OUT	Link/Activity Output
	RX/TX	Receive/Transmit

## 8.2 Overview LEDs Fieldbus Systems







LED	PROFIBUS DP or PROFIBUS MPI (1 Duo LED)	CANopen (1 Duo LED)	DeviceNet (1 Duo LED)	CC-Link (Slave) (2 LEDs)
System Status  (gelb/green)	<b>SYS</b>	<b>SYS</b>	<b>SYS</b>	<b>SYS</b>
Communication Status	<b>COM</b>  (red/green)	<b>CAN</b>  (red/green)	<b>MNS</b>  (red/green)	<b>L RUN</b>  (green) <b>L ERR</b>  (red)

Table 41: Overview LEDs by Fieldbus System for 1 Channel Devices











LED	PROFIBUS DP or PROFIBUS MPI (2 LEDs or 1 AIFX-DP/channel)	CANopen (2 LEDs or 1 AIFX-CO/channel)	DeviceNet (1 Duo LED/ channel)
System Status  (yellow/green)	<b>SYS</b>	<b>SYS</b>	<b>SYS</b>
Communication Status Channel X3 (SYCONnet: Ch0)	<b>ERR0</b>  (red) <b>STA0</b>  (green)	<b>ERR0</b>  (red) <b>RUN0</b>  (green)	<b>MNS0</b>  (red/green)
Channel X4 (SYCONnet: Ch1)	<b>ERR1</b>  (red) <b>STA1</b>  (green)	<b>ERR</b>  (red) <b>RUN</b>  (green)	<b>MNS1</b>  (red/green)

Table 42: Overview LEDs by Fieldbus System for 2 Channel Devices (only PC Cards cifX Mini PCI Express)

LED	Name	Meaning
System Status	SYS	System Status
Communication Status	COM	Communication Status
	RUN	Run
	ERR	Error
	STA	Status
	CAN	CANopen Status
	MNS	Module Network Status
	L RUN / L ERR	Status Run / Status Error

Table 43: LED Names

## 8.3 System LED

The System Status LED **SYS** can assume the states described below.





LED	Color	State	Meaning
<b>SYS</b>	<b>Duo LED yellow/green</b>		
	 (green)	On	Operating System running
	 (green/yellow)	Blinking	Second stage bootloader is waiting for firmware.
	 (yellow)	On	Bootloader netX (= romloader) is waiting for second stage bootloader.
	 (off)	Off	Power supply for the device is missing or hardware defect.

Table 44: System Status LED States

LED State	Definition
On	The indicator is constantly on.
Off	The indicator is constantly off.
Blinking	The indicator turns on and off cyclically.

Table 45: System Status LED State Definitions

## 8.4 Power On LED

The power On LED **PWR** can assume the states described below.



LED	Color	State	Meaning
<b>PWR</b>	<b>LED green</b>		
	 (green)	On	Power supply for the device on.
	 (off)	Off	Power supply for the device is missing.

Table 46: Power On LED States

LED state	Definition
On	The indicator is constantly on.
Off	The indicator is constantly off.

Table 47: Power On LED state definitions



## 8.5 EtherCAT Master

For the EtherCAT Master protocol, the communication LEDs **RUN** and **ERR** as well as the Ethernet LEDs **LINK** and **ACT** can assume the states described below. This description is valid from stack version V3.0.











LED	Color	State	Meaning
<b>RUN</b> General name: <b>COM 0</b>	<b>Duo LED red/green</b>		
	 (off)	Off	<b>INIT:</b> The device is in state INIT.
	 (green)	Blinking (2,5 Hz)	<b>PRE-OPERATIONAL:</b> The device is in PRE-OPERATIONAL state.
	 (green)	Flickering (10 Hz)	<b>BOOT:</b> Device is in Boot mode.
	 (green)	Single flash	<b>SAFE-OPERATIONAL:</b> The device is in SAFE-OPERATIONAL state.
	 (green)	On	<b>OPERATIONAL:</b> The device is in OPERATIONAL state.
<b>ERR</b> General name: <b>COM 1</b>	<b>Duo-LED red/green</b>		
	 (off)	Off	Master has no errors.
	 (red)	On	Master has detected a communication error. The error is indicated in the DPM.
<b>LINK</b> Ch0	<b>LED green</b>		
	 (green)	On	The device is linked to the Ethernet.
	 (off)	Off	The device has no link to the Ethernet.
<b>ACT</b> Ch0	<b>LED yellow</b>		
	 (yellow)	Flickering (load dependant)	The device sends/receives Ethernet frames.
	 (off)	Off	The device does not send/receive Ethernet frames.

Table 48: LED states for the EtherCAT Master protocol

LED State	Definition
On	The indicator is constantly on.
Off	The indicator is constantly off.
Blinking (2,5 Hz)	The indicator turns on and off with a frequency of 2,5 Hz: "on" for 200 ms, followed by "off" for 200 ms.
Flickering (10 Hz)	The indicator turns on and off with a frequency of 10 Hz: "on" for 50 ms, followed by "off" for 50 ms.
Single flash	The indicator shows one short flash (200 ms) followed by a long "off" phase (1,000 ms).
Flickering (load dependant)	The indicator turns on and off with a frequency of approximately 10 Hz to indicate high Ethernet activity: on for approximately 50 ms, followed by off for 50 ms. The indicator turns on and off in irregular intervals to indicate low Ethernet activity.

Table 49: LED state definitions for the EtherCAT Master protocol

## 8.6 EtherCAT Slave

For the EtherCAT Slave protocol, the communication LEDs **RUN** and **ERR** as well as the Ethernet-LED **L/A IN** or **L/A OUT** can assume the states described below. This description is valid from stack version V2.5 (V2).













LED	Color	State	Meaning
<b>RUN</b> General name: <b>COM 0</b>	<b>Duo LED red/green</b>		
	 (off)	Off	<b>INIT:</b> The device is in state INIT.
	 (green)	Blinking (2,5 Hz)	<b>PRE-OPERATIONAL:</b> The device is in PRE-OPERATIONAL state.
	 (green)	Single flash	<b>SAFE-OPERATIONAL:</b> The device is in SAFE-OPERATIONAL state.
	 (green)	On	<b>OPERATIONAL:</b> The device is in OPERATIONAL state.
<b>ERR</b> General name: <b>COM 1</b>	<b>Duo-LED red/green</b>		
	 (off)	Off	<b>No error:</b> The EtherCAT communication of the device is in working condition.
	 (red)	Blinking (2,5 Hz)	<b>Invalid configuration:</b> General Configuration Error Possible reason: State change commanded by master is impossible due to register or object settings.
	 (red)	Single Flash	<b>Local error:</b> Slave device application has changed the EtherCAT state autonomously. Possible reason 1: A host watchdog timeout has occurred. Possible reason 2: Synchronization Error, device enters Safe-Operational automatically.
	 (red)	Double Flash	<b>Application watchdog timeout:</b> An application watchdog timeout has occurred. Possible reason: Sync Manager Watchdog timeout.
<b>L/A IN</b> or <b>L/A OUT</b>	<b>LED green</b>		
	 (green)	On	<b>Link:</b> The device is linked to the Ethernet, but does not send/receive Ethernet frames.
	 (green)	Flickering (load dependant)	<b>Activity:</b> The device is linked to the Ethernet and sends/receives Ethernet frames.
	 (off)	Off	The device has no link to the Ethernet.
	<b>LED yellow</b>		
	 (off)	Off	This LED is not used.

Table 50: LED states for the EtherCAT Slave protocol

LED State	Beschreibung
On	The indicator is constantly on.
Off	The indicator is constantly off.
Blinking (2,5 Hz)	The indicator turns on and off with a frequency of 2,5 Hz: "on" for 200 ms, followed by "off" for 200 ms.
Single flash	The indicator shows one short flash (200 ms) followed by a long "off" phase (1,000 ms).
Double flash	The indicator shows a sequence of two short flashes (each 200 ms), separated by a short off phase (200 ms). The sequence is finished by a long off phase (1,000 ms).
Flickering (load dependant)	The indicator turns on and off with a frequency of approximately 10 Hz to indicate high Ethernet activity: on for approximately 50 ms, followed by off for 50 ms. The indicator turns on and off in irregular intervals to indicate low Ethernet activity.

Table 51: LED state definitions for the EtherCAT Slave protocol

## 8.7 EtherNet/IP Scanner (Master)

For the EtherNet/IP Scanner protocol, the communication LEDs **MS** and **NS** as well as the Ethernet LEDs **LINK** and **ACT** can assume the states described below. This description is valid from stack version V2.6.

















LED	Color	State	Meaning
<b>MS</b> (Module status) General name: <b>COM 0</b>	<b>Duo-LED red/green</b>		
	 (green)	On	<b>Device operational:</b> The device is operating correctly.
	 (green)	Flashing (1 Hz)	<b>Standby:</b> The device has not been configured.
	 (red/green)	Flashing (1 Hz)	<b>Self-test:</b> The device is performing its power up testing.
	 (red)	Flashing (1 Hz)	<b>Minor fault:</b> The device has detected a recoverable minor fault. E. g. an incorrect or inconsistent configuration can be considered as a minor fault.
	 (red)	On	<b>Major fault:</b> The device has detected a non-recoverable major fault.
	 (Off)	Off	<b>No power:</b> The power supply to the device is missing.
<b>NS</b> (Network-status) General name:: <b>COM 1</b>	<b>Duo-LED red/green</b>		
	 (green)	On	<b>Connected:</b> The device has at least one established connection (even to the Message Router).
	 (green)	Flashing (1 Hz)	<b>No connections:</b> The device has no established connections, but has obtained an IP address.
	 (red/green)	Flashing (1 Hz)	<b>Self-test:</b> The device is performing its power up testing.
	 (red)	Flashing (1 Hz)	<b>Connection timeout:</b> One or more of the connections in which this device is the target have timed out. This status will be finished only if all timed out connections are reestablished or if the device is reset.
	 (red)	On	<b>Duplicate IP:</b> The device has detected that its IP address is already in use.
	 (Off)	Off	<b>Not powered, no IP address:</b> The device does not have an IP address (or is powered off).
<b>LINK</b> Ch0 & Ch1	<b>LED green</b>		
	 (green)	On	The device is linked to the Ethernet.
	 (Off)	Off	The device has no link to the Ethernet.
<b>ACT</b> Ch0 & Ch1	<b>LED yellow</b>		
	 (yellow)	Flickering (load dependant)	The device sends/receives Ethernet frames.
	 (Off)	Off	The device does not send/receive Ethernet frames.

Table 52: LED states for the EtherNet/IP Scanner protocol

LED state	Definition
On	The indicator is constantly on.
Off	The indicator is constantly off.
Flashing (1 Hz)	The indicator turns on and off with a frequency of 1 Hz: "on" for 500 ms, followed by "off" for 500 ms.
Flickering (load dependant)	The indicator turns on and off with a frequency of approximately 10 Hz to indicate high Ethernet activity: on for approximately 50 ms, followed by off for 50 ms. The indicator turns on and off in irregular intervals to indicate low Ethernet activity.

Table 53: LED state definitions for the EtherNet/IP Scanner protocol

## 8.8 EtherNet/IP Adapter (Slave)

For the EtherNet/IP Adapter protocol, the communication LEDs **MS** and **NS** as well as the Ethernet LEDs **LINK** and **ACT** can assume the states described below. This description is valid from stack version V2.7 (V2) or from V3.0.

















LED	Color	State	Meaning
<b>MS</b> (Module status) General name: <b>COM 0</b>	<b>Duo-LED red/green</b>		
	 (green)	On	<b>Device operational:</b> The device is operating correctly.
	 (green)	Flashing (1 Hz)	<b>Standby:</b> The device has not been configured.
	 (red/green)	Flashing (1 Hz)	<b>Self-test:</b> The device is performing its power up testing.
	 (red)	Flashing (1 Hz)	<b>Minor fault:</b> The device has detected a recoverable minor fault. E. g. an incorrect or inconsistent configuration can be considered as a minor fault.
	 (red)	On	<b>Major fault:</b> The device has detected a non-recoverable major fault.
	 (Off)	Off	<b>No power:</b> The power supply to the device is missing.
<b>NS</b> (Network-status) General name: <b>COM 1</b>	<b>Duo-LED red/green</b>		
	 (green)	On	<b>Connected:</b> The device has at least one established connection (even to the Message Router).
	 (green)	Flashing (1 Hz)	<b>No connections:</b> The device has no established connections, but has obtained an IP address.
	 (red/green)	Flashing (1 Hz)	<b>Self-test:</b> The device is performing its power up testing.
	 (red)	Flashing (1 Hz)	<b>Connection timeout:</b> One or more of the connections in which this device is the target have timed out. This status will be finished only if all timed out connections are reestablished or if the device is reset.
	 (red)	On	<b>Duplicate IP:</b> The device has detected that its IP address is already in use.
	 (Off)	Off	<b>Not powered, no IP address:</b> The device does not have an IP address (or is powered off).
<b>LINK</b> Ch0 & Ch1	<b>LED green</b>		
	 (green)	On	The device is linked to the Ethernet.
	 (Off)	Off	The device has no link to the Ethernet.
<b>ACT</b> Ch0 & Ch1	<b>LED yellow</b>		
	 (yellow)	Flickering (load dependant)	The device sends/receives Ethernet frames.
	 (Off)	Off	The device does not send/receive Ethernet frames.

Table 54: LED states for the EtherNet/IP Adapter protocol

LED state	Definition
On	The indicator is constantly on.
Off	The indicator is constantly off.
Flashing (1 Hz)	The indicator turns on and off with a frequency of 1 Hz: "on" for 500 ms, followed by "off" for 500 ms.
Flickering (load dependant)	The indicator turns on and off with a frequency of approximately 10 Hz to indicate high Ethernet activity: on for approximately 50 ms, followed by off for 50 ms. The indicator turns on and off in irregular intervals to indicate low Ethernet activity.

Table 55: LED state definitions for the EtherNet/IP Adapter protocol

## 8.9 Open Modbus/TCP

For the OpenModbusTCP protocol, the communication LEDs **RUN** and **ERR** as well as the Ethernet LEDs **LINK** and **ACT** can assume the states described below. This description is valid from stack version V2.5.











LED	Color	State	Meaning
<b>RUN</b> General name: COM 0	<b>Duo-LED red/green</b>		
	 (green)	On	<b>Connected:</b> OMB task has communication. At least one TCP connection is established.
	 (green)	Flashing (1 Hz)	<b>Ready, not yet configured:</b> OMB task is ready and not yet configured.
	 (green)	Flashing (5 Hz)	<b>Waiting for Communication:</b> OMB task is configured.
	 (off)	Off	<b>Not Ready:</b> OMB task is not ready.
<b>ERR</b> General name: COM 1	<b>Duo-LED red/green</b>		
	 (off)	Off	No communication error
	 (red)	Flashing (2 Hz, 25% on)	System error
	 (red)	On	Communication error active
<b>LINK</b> Ch0 & Ch1	<b>LED green</b>		
	 (green)	On	The device is linked to the Ethernet.
	 (off)	Off	The device has no link to the Ethernet.
<b>ACT</b> Ch0 & Ch1	<b>LED yellow</b>		
	 (yellow)	Flickering (load dependant)	The device sends/receives Ethernet frames.
	 (off)	Off	The device does not send/receive Ethernet frames.

Table 56: LED states for the OpenModbusTCP protocol

LED state	Definition
On	The indicator is constantly on.
Off	The indicator is constantly off.
Flashing (1 Hz)	The indicator turns on and off with a frequency of 1 Hz: "on" for 500 ms, followed by "off" for 500 ms.
Flashing (2 Hz, 25% on)	The indicator turns on and off with a frequency of 2 Hz: "on" for 125 ms, followed by "off" for 375 ms.
Flashing (5 Hz)	The indicator turns on and off with a frequency of 5 Hz: "on" for 100 ms, followed by "off" for 100 ms.
Flickering (load dependant)	The indicator turns on and off with a frequency of approximately 10 Hz to indicate high Ethernet activity: on for approximately 50 ms, followed by off for 50 ms. The indicator turns on and off in irregular intervals to indicate low Ethernet activity.

Table 57: LED state definitions for the OpenModbusTCP protocol

## 8.10 POWERLINK Controlled Node/Slave

For the POWERLINK Controlled Node protocol, the communication LEDs **BS** (Bus Status) and **BE** (Bus Error) as well as the Ethernet LED **L/A** can assume the states described below. This description is valid from stack version V2.1.













LED	Color	State	Meaning
<b>BS</b> (Bus Status) General name: <b>COM 0</b>	<b>Duo LED red/green</b>		
	 (green)	On	Slave is in ' <b>Operational</b> ' state
	 (green)	Triple Flash	Slave is in ' <b>ReadyToOperate</b> ' state
	 (green)	Double flash	Slave is in ' <b>Pre-Operational 2</b> ' state
	 (green)	Single flash	Slave is in ' <b>Pre-Operational 1</b> ' state
	 (red/green)	Flickering (10 Hz)	Slave is in ' <b>Basic Ethernet</b> ' state
	 (red/green)	Blinking (2,5 Hz)	Slave is in ' <b>Stopped</b> ' state
	 (off)	Off	Slave initializing
<b>BE</b> (Bus Error) General name: <b>COM 1</b>	<b>Duo LED red/green</b>		
	 (off)	Off	Slave has no error
	 (red)	On	Slave has detected an error
<b>L/A</b> Ch0 & Ch1	<b>LED green</b>		
	 (green)	On	<b>Link:</b> The device is linked to the Ethernet, but does not send/receive Ethernet frames.
	 (green)	Flickering (load dependant)	<b>Activity:</b> The device is linked to the Ethernet and sends/receives Ethernet frames.
	 (off)	Off	The device has no link to the Ethernet.
Ch0 & Ch1	<b>LED yellow</b>		
	 (off)	Off	This LED is not used.

Table 58: LED states for the POWERLINK Controlled Node protocol

LED state	Definition
On	The indicator is constantly on.
Off	The indicator is constantly off.
Triple Flash	The indicator shows a sequence of three short flashes (each 200 ms), separated by a short off phase (200 ms). The sequence is finished by a long off phase (1,000 ms).
Double flash	The indicator shows a sequence of two short flashes (each 200 ms), separated by a short off phase (200 ms). The sequence is finished by a long off phase (1,000 ms).
Single flash	The indicator shows one short flash (200 ms) followed by a long "off" phase (1,000 ms).
Flickering (10 Hz)	The indicator turns on and off with a frequency of approximately 10 Hz: on for approximately 50 ms, followed by off for 50 ms. Red and green LEDs shall be on alternately.
Blinking (2,5 Hz)	The indicator turns on and off with a frequency of approximately 2.5 Hz: on for approximately 200 ms, followed by off for 200 ms. Red and green LEDs shall be on alternately.
Flickering (load dependant)	The indicator turns on and off with a frequency of approximately 10 Hz to indicate high Ethernet activity: on for approximately 50 ms, followed by off for 50 ms. The indicator turns on and off in irregular intervals to indicate low Ethernet activity.

Table 59: LED state definitions for the POWERLINK Controlled Node protocol

## 8.11 PROFINET IO-Controller

For the PROFINET IO-Controller protocol, the communication LEDs **SF** (system failure) and **BF** (bus failure) as well as the Ethernet LEDs **LINK** and **RX/TX** can assume the states described below. This description is valid from stack version V2.6.













LED	Color	State	Meaning
<b>SF</b> (System Failure) General name: <b>COM 0</b>	<b>Duo LED red/green</b>		
	 (off)	Off	<b>No error</b>
	 (red)	Flashing (1 Hz, 3 s)	<b>DCP signal service</b> is initiated via the bus.
	 (red)	Flashing (2 Hz)	<b>System error:</b> Invalid configuration, Watchdog error or internal error
	 (red)	On (together with SF „red ON)	<b>System error:</b> Invalid configuration, Watchdog error or internal error
<b>BF</b> (Bus Failure) General name: <b>COM 1</b>	<b>Duo LED red/green</b>		
	 (off)	Off	<b>No error</b>
	 (red)	Flashing (2 Hz)	<b>Configuration fault:</b> Not all configured IO-Devices are connected.
	 (red)	On (together with SF „red ON")	<b>No valid Master license</b>
	 (red)	On (together with SF „red OFF")	<b>No Connection:</b> No Link.
<b>LINK</b> Ch0 & Ch1	<b>LED green</b>		
	 (green)	On	The device is linked to the Ethernet.
	 (off)	Off	The device has no link to the Ethernet.
<b>RX/TX</b> Ch0 & Ch1	<b>LED yellow</b>		
	 (gelb)	Flickering (load dependant)	The device sends/receives Ethernet frames.
	 (off)	Off	The device does not send/receive Ethernet frames.

Table 60: LED states for the PROFINET IO-Controller protocol

LED state	Definition
On	The indicator is constantly on.
Off	The indicator is constantly off.
Flashing (1 Hz, 3 s)	The indicator turns on and off for 3 seconds with a frequency of 1 Hz: "on" for 500 ms, followed by "off" for 500 ms.
Flashing (2 Hz)	The indicator turns on and off with a frequency of 2 Hz: "on" for 250 ms, followed by "off" for 250 ms.
Flickering (load dependant)	The indicator turns on and off with a frequency of approximately 10 Hz to indicate high Ethernet activity: on for approximately 50 ms, followed by off for 50 ms. The indicator turns on and off in irregular intervals to indicate low Ethernet activity.

Table 61: LED state definitions for the PROFINET IO-Controller protocol

## 8.12 PROFINET IO-Device

For the PROFINET IO-Device protocol, the communication LEDs **SF** (System Failure) and **BF** (Bus Failure) as well as the Ethernet LEDs **LINK** and **RX/TX** can assume the states described below. This description is valid from stack version V3.x (V3).











LED	Color	State	Meaning
<b>SF</b> (System Failure) General name: <b>COM 0</b>	<b>Duo LED red/green</b>		
	 (off)	Off	No error
	 (red)	Flashing (1 Hz, 3 s)	DCP signal service is initiated via the bus.
	 (red)	On	Watchdog timeout; channel, generic or extended diagnosis present; system error
<b>BF</b> (Bus Failure) General name: <b>COM 1</b>	<b>Duo LED red/green</b>		
	 (off)	Off	No error
	 (red)	Flashing (2 Hz)	No data exchange
	 (red)	On	No configuration; or low speed physical link; or no physical link
<b>LINK</b> Ch0 & Ch1	<b>LED green</b>		
	 (green)	On	The device is linked to the Ethernet.
	 (off)	Off	The device has no link to the Ethernet.
<b>RX/TX</b> Ch0 & Ch1	<b>LED yellow</b>		
	 (gelb)	Flickering (load dependant)	The device sends/receives Ethernet frames.
	 (off)	Off	The device does not send/receive Ethernet frames.

Table 62: LED states for the PROFINET IO-Device protocol

LED state	Definition
On	The indicator is constantly on.
Off	The indicator is constantly off.
Flashing (1 Hz, 3 s)	The indicator turns on and off for 3 seconds with a frequency of 1 Hz: "on" for 500 ms, followed by "off" for 500 ms.
Flashing (2 Hz)	The indicator turns on and off with a frequency of 2 Hz: "on" for 250 ms, followed by "off" for 250 ms.
Flickering (load dependant)	The indicator turns on and off with a frequency of approximately 10 Hz to indicate high Ethernet activity: on for approximately 50 ms, followed by off for 50 ms. The indicator turns on and off in irregular intervals to indicate low Ethernet activity.

Table 63: LED state definitions for the PROFINET IO-Device protocol



## 8.13 sercos Master

For the sercos Master protocol, the communication LEDs **STA** and **ERR** as well as the Ethernet LED **L/A** can assume the states described below. This description is valid from stack version V2.1.





















LED	Color	State	Meaning
<b>STA</b> General name: <b>COM 0</b>	<b>Duo LED red/green</b>		
	 (green)	On	<b>CP4: Communication phase 4</b>
	 (green)	Triple Flash	<b>CP3: Communication phase 3</b>
	 (green)	Double flash	<b>CP2: Communication phase 2</b>
	 (green)	Single flash	<b>CP1: Communication phase 1</b>
	 (green)	Blinking (2,5 Hz)	<b>CP0: Communication phase 0</b>
	 (green)	Flickering (10 Hz)	<b>Master is not configured and is in NRT.</b> After a status change this isn't indicated again
	 (off)	Off	<b>NRT: Non Real-Time Mode</b>
<b>ERR</b> General name: <b>COM 1</b>	<b>Duo LED red/green</b>		
	 (red)	Single flash	Bus Sync error threshold
	 (red)	Double flash	Internal Stop of the bus cycle
	 (red)	Triple Flash	DPM watchdog has expired.
	 (red)	Quadruple Flash	No Master license present in the device.
	 (red)	Blinking (2,5 Hz)	Error in the configuration database.
	 (red)	Single Flickering	Channel Init was executed at the Master.
	 (red)	Double Flickering	Slave is missing.
	 (red)	Flickering (10 Hz)	Boot-up was stopped due to an error.
 (off)	Off	No error	
<b>L/A</b> Ch0 & Ch1	<b>LED green</b>		
	 (green)	On	<b>Link:</b> The device is linked to the Ethernet, but does not send/receive Ethernet frames.
	 (green)	Flickering (load dependant)	<b>Activity:</b> The device is linked to the Ethernet and sends/receives Ethernet frames.
	 (off)	Off	The device has no link to the Ethernet.
Ch0 & Ch1	<b>LED yellow</b>		
	 (off)	Off	This LED is not used.

Table 64: LED states for the sercos Master protocol

LED state	Definition
On	The indicator is constantly on.
Off	The indicator is constantly off.
Single flash	The indicator shows one short flash (200 ms) followed by a long "off" phase (1,000 ms).
Double flash	The indicator shows a sequence of two short flashes (each 200 ms), separated by a short off phase (200 ms). The sequence is finished by a long off phase (1,000 ms).
Triple Flash	The indicator shows a sequence of three short flashes (each 200 ms), separated by a short off phase (200 ms). The sequence is finished by a long off phase (1,000 ms).
Quadruple Flash	The indicator shows a sequence of four short flashes (each 200 ms), separated by a short off phase (200 ms). The sequence is finished by a long off phase (1,000 ms).
Blinking (2,5 Hz)	The indicator turns on and off with a frequency of 2,5 Hz: "on" for 200 ms, followed by "off" for 200 ms.
Single Flickering	The indicator is switched on and off once: 'on' for 50 ms, followed by 'off' for 500 ms.
Double Flickering	The indicator is switched on and off and on once: 'on' / 'off' / 'on' each for approximately 50 ms, followed by 'off' for 500 ms.
Flickering (10 Hz)	The indicator turns on and off with a frequency of 10 Hz: 'on' for 50 ms, followed by 'off' for 50 ms.
Flickering (load dependant)	The indicator turns on and off with a frequency of approximately 10 Hz to indicate high Ethernet activity: 'on' for approximately 50 ms, followed by 'off' for 50 ms. The indicator turns on and off in irregular intervals to indicate low Ethernet activity.

*Table 65: LED state definitions for the sercos Master protocol*

## 8.14 sercos Slave

For the sercos Slave protocol, the communication LED **S** as well as the Ethernet LED **L/A** can assume the states described below. This description is valid from stack version V3.1.

















LED	Color	State	Meaning
<b>S</b> General name: <b>COM 0</b>	<b>Duo LED red/green</b> (orange = red/green simultaneously)		
	 (green)	On	<b>CP4: Communication phase 4:</b> Normal operation, no error
	 (green)	Blinking (2 Hz)	<b>Loopback:</b> The network state has changed from „fast-forward“ to „loopback“.
	 (green/orange)	Flashing (3 x green/3s)	<b>CP3: Communication phase 3</b>
		(2 x green/3s)	<b>CP2: Communication phase 2</b>
		(1 x green/3s)	<b>CP1: Communication phase 1</b>
	 (orange)	On	<b>CP0: Communication phase 0</b>
	 (orange/green)	Blinking (2 Hz)	<b>HP0:</b> Hot-plug mode (not yet implemented)
		(1 x orange/3s)	<b>HP1:</b> Hot-plug mode (not yet implemented)
		(2 x orange/3s)	<b>HP2:</b> Hot-plug mode (not yet implemented)
	 (orange)	Flashing (2 Hz)	<b>Identification:</b> Corresponds to C-DEV.Bit 15 in the Slave's Device Control indicating remote address allocation or configuration errors between Master and Slaves (for details refer to sercos Slave V3 Protocol API Manual).
	 (green/red)	Flashing (2 Hz, min. 2s)	<b>MST losses ≥ (S-0-1003/2):</b> Depends on IDN S-0-1003 (for details refer to sercos Slave Protocol API manual). Corresponds to S-DEV.Bit 15 in the Device Status indicating a communication warning (Master SYNC telegrams have not been received).
	 (red/orange)	Flashing (2 Hz)	<b>Application error (C1D):</b> See GDP & FSP Status codes class error, (see sercos Slave V3 Protocol API Manual).
 (red)	Flashing (2 Hz)	<b>Watchdog error:</b> Application is not running (not yet implemented)	
 (red)	On	<b>Communication Error (C1D):</b> Error detected according to sercos third generation Class 1 Diagnosis, see SCP Status codes class error (see sercos Slave V3 Protocol API Manual).	
 (off)	Off	<b>NRT-Mode:</b> (Non Real-Time Mode) No sercos Communication	
General name: <b>COM 1</b>	<b>Duo LED red/green</b>		
	 (off)	Off	This LED is not used.
<b>L/A</b> Ch0 & Ch1	LED green		
	 (green)	On	<b>Link:</b> The device is linked to the Ethernet, but does not send/receive Ethernet frames.
	 (green)	Flickering (load dependant)	<b>Activity:</b> The device is linked to the Ethernet and sends/receives Ethernet frames.
	 (off)	Off	The device has no link to the Ethernet.
Ch0 & Ch1	LED yellow		
	 (off)	Off	This LED is not used.

Table 66: LED state definitions for the sercos Slave protocol

LED state	Definition
On	The indicator is constantly on.
Off	The indicator is constantly off.
Flashing (2 Hz)	The indicator turns on and off with a frequency of 2 Hz: <i>one color</i> : On for appr. 250 ms, followed by off for appr. 250 ms. <i>two colors</i> : First color for appr. 250 ms, followed by the second color for appr. 250 ms.
Flashing (1 x green/3s) (2 x green/3s) (3 x green/3s) (1 x orange/3s) (2 x orange/3s)	Flashing green for 250 ms, then orange on for 2 second and 750 ms. Flashing green / orange / green, each for 250 ms, then orange on for 2 seconds and 250 ms. Flashing green / orange / green / orange / green, each for 250 ms, then orange on for 1 second and 750 ms. Flashing orange for 250 ms, then green on for 2 second an 750 ms. Flashing orange / green / orange, each for 250 ms, then green on for 2 seconds and 250 ms.
Flickering (load dependant)	The indicator turns on and off with a frequency of approximately 10 Hz to indicate high Ethernet activity: "on" for approximately 50 ms, followed by "off" for 50 ms. The indicator turns on and off in irregular intervals to indicate low Ethernet activity.

*Table 67: LED state definitions for the sercos Slave protocol*

## 8.15 VARAN Client (Slave)

For the VARAN Client protocol, the communication LEDs **RUN** and **ERR** as well as the Ethernet LEDs **LINK** and **ACT** can assume the states described below. This description is valid from stack version V1.0.









LED	Color	State	Meaning
<b>RUN</b> General name: <b>COM 0</b>	<b>Duo-LED red/green</b>		
	 (green)	On	Configured and communication is active.
	 (green)	Blinking (5 Hz)	Configured and communication is inactive.
	 (off)	Off	Not configured.
<b>ERR</b> General name: <b>COM 1</b>	<b>Duo-LED red/green</b>		
	 (off)	Off	Configured.
	 (red)	Blinking (5 Hz)	Not configured.
<b>LINK</b> Ch0 & Ch1	<b>LED green</b>		
	 (green)	On	The device is linked to the Ethernet.
	 (off)	Off	The device has no link to the Ethernet.
<b>ACT</b> Ch0 & Ch1	<b>LED yellow</b>		
	 (yellow)	Flickering (load dependant)	The device sends/receives Ethernet frames.
	 (off)	Off	The device does not send/receive Ethernet frames.

Table 68: LED-Zustände für das VARAN-Client-Protokoll







LED state	Definition
On	The indicator is constantly on.
Off	The indicator is constantly off.
Blinking (5 Hz)	The indicator turns on and off with a frequency of 5 Hz: "on" for 100 ms, followed by "off" for 100 ms.
Flickering (load dependant)	The indicator turns on and off with a frequency of approximately 10 Hz to indicate high Ethernet activity: on for approximately 50 ms, followed by off for 50 ms. The indicator turns on and off in irregular intervals to indicate low Ethernet activity.

Table 69: Definitionen der LED-Zustände für das VARAN-Client-Protokoll

## 8.16 PROFIBUS DP Master

### 8.16.1 1 Communication Status LED

For the PROFIBUS DP Master protocol, the communication status LED **COM** can assume the states described below. This description is valid from stack version V2.6.

LED	Color	State	Meaning
<b>cifX with 1 Communication Status LED</b> (current Hardware Revision)			
<b>COM</b>	<b>Duo LED red/green</b>		
	 (green)	On	Communication to all Slaves is established.
	 (green)	Flashing (5 Hz)	PROFIBUS is configured, but bus communication is not yet released from the application.
	 (green)	Flashing acyclic	No configuration or faulty configuration
	 (red)	Flashing (5 Hz)	Communication to at least one Slave is disconnected.
	 (red)	On	Communication to all Slaves is disconnected or another serious error has occurred. Redundant Mode: The active Master was not found.
 (off)	Off	Device is not switched on or network power is missing.	

*Table 70: LED states for the PROFIBUS DP Master protocol – 1 Communication Status LED (current Hardware Revision)*

LED State	Definition
On	The indicator is constantly on.
Off	The indicator is constantly off.
Flashing (5 Hz)	The indicator turns on and off with a frequency of 5 Hz: "on" for 100 ms, followed by "off" for 100 ms.
Flashing acyclic	The indicator turns on and off in irregular intervals.

*Table 71: LED state definitions for the PROFIBUS DP Master protocol*

## 8.16.2 2 Communication Status LEDs

For the PROFIBUS DP Master protocol, the communication status LEDs **STA** and **ERR** can assume the states described below. This description is valid from stack version V2.6.







LED	Color	State	Meaning
<b>cifX with 2 Communication Status LEDs</b> (AIFX-DP is connected or for prior Hardware Revisions)			
<b>STA</b>	<b>LED green</b>		
	 (green)	On	Communication to all Slaves is established.
	 (green)	Flashing (5 Hz)	PROFIBUS is configured, but bus communication is not yet released from the application.
	 (green)	Flashing acyclic	No configuration or faulty configuration
	 (off)	Off	<i>LED red is off</i> : Device is not switched on or network power is missing. <i>LED red is flashing or "on"</i> : Refer to description LED red.
<b>ERR</b>	<b>LED red</b>		
	 (off)	Off	Refer to description for LED green.
	 (red)	Flashing (5 Hz)	Communication to at least one Slave is disconnected.
	 (off)	On	Communication to all Slaves is disconnected or another serious error has occurred. Redundant Mode: The active Master was not found.

Table 72: LED states for the PROFIBUS DP Master protocol – 2 Communication Status LEDs (AIFX-DP connected or prior Hardware Revision)







LED State	Definition
On	The indicator is constantly on.
Off	The indicator is constantly off.
Flashing (5 Hz)	The indicator turns on and off with a frequency of 5 Hz: "on" for 100 ms, followed by "off" for 100 ms.
Flashing acyclic	The indicator turns on and off in irregular intervals.

Table 73: LED state definitions for the PROFIBUS DP Master protocol

## 8.17 PROFIBUS DP Slave

### 8.17.1 1 Communication Status LED

For the PROFIBUS DP Slave protocol, the communication status LED **COM** can assume the states described below. This description is valid from stack version V2.7.

LED	Color	State	Meaning
<b>cifX with 1 Communication Status LED</b> (current Hardware Revision)			
<b>COM</b>	<b>Duo LED red/green</b>		
	 (green)	On	RUN, cyclic communication
	 (green)	Flashing, cyclic (2 Hz)	Master is in CLEAR state.
	 (red)	Flashing, acyclic (1 Hz)	Device is not configured.
	 (red)	Flashing, cyclic (2 Hz)	STOP, no communication, connection error
	 (red)	On	Wrong configuration at PROFIBUS DP Slave.
	 (off)	Off	Device is not switched on or network power is missing.

*Table 74: LED states for the PROFIBUS DP Slave protocol – 1 Communication Status LED (current Hardware Revision)*

LED State	Definition
On	The indicator is constantly on.
Off	The indicator is constantly off.
Flashing, acyclic (1 Hz)	The indicator turns on and off in irregular intervals, with a frequency of 1 Hz: "on" for 750 ms, followed by "off" for 250 ms.
Flashing, cyclic (2 Hz)	The indicator turns on and off with a frequency of 2 Hz: "on" for 250 ms, followed by "off" for 250 ms.

*Table 75: LED state definitions for the PROFIBUS DP Slave protocol*



## 8.17.2 2 Communication Status LEDs

For the PROFIBUS DP Slave protocol, the communication status LEDs **STA** and **ERR** can assume the states described below. This description is valid from stack version V2.7.







LED	Color	State	Meaning
<b>cifX with 2 Communication Status LEDs</b> (AIFX-DP is connected or for prior Hardware Revisions)			
<b>STA</b>	<b>LED green</b>		
	 (green)	On	RUN, cyclic communication
	 (green)	Flashing, cyclic (2 Hz)	Master is in CLEAR state.
	 (off)	Off	<i>LED red is off:</i> Device is not switched on or network power is missing. <i>LED red is flashing or on:</i> Refer to description LED red.
<b>ERR</b>	<b>LED red</b>		
	 (off)	Off	Refer to description for LED green.
	 (red)	Flashing, acyclic (1 Hz)	Device is not configured.
	 (red)	Flashing, cyclic (2 Hz)	STOP, no communication, connection error
	 (red)	On	Wrong configuration at PROFIBUS DP Slave.

Table 76: LED states for the PROFIBUS DP Slave protocol – 2 Communication Status LEDs (AIFX-DP connected or prior Hardware Revision)

LED State	Definition
On	The indicator is constantly on.
Off	The indicator is constantly off.
Flashing, acyclic (1 Hz)	The indicator turns on and off in irregular intervals, with a frequency of 1 Hz: “on” for 750 ms, followed by “off” for 250 ms.
Flashing, cyclic (2 Hz)	The indicator turns on and off with a frequency of 2 Hz: “on” for 250 ms, followed by “off” for 250 ms.

Table 77: LED state definitions for the PROFIBUS DP Slave protocol

## 8.18 PROFIBUS MPI Device

### 8.18.1 1 Communication Status LED

For the PROFIBUS MPI protocol, the communication status LED **COM** can assume the states described below. This description is valid from stack version V2.4.





LED	Color	State	Meaning
<b>cifX with 1 Communication Status LED</b>			
<b>COM</b>	<b>Duo LED red/green</b>		
	 (green)	On	<b>Status:</b> The device currently holds the PROFIBUS token and is able to transfer telegrams of data.
	 (green)	Blinking (5 Hz)	<b>Status:</b> The device is configured to be a part of the PROFIBUS ring, but it must share the PROFIBUS token with other PROFIBUS-Master devices present on the PROFIBUS ring.
	 (green)	Blinking (0.5 Hz)	<b>Status:</b> Automatic baudrate detection is running
	 (off)	Off	<b>Status:</b> The device has not been integrated into the PROFIBUS ring, i.e. it has not been configured correctly or has a wrong configuration or has not received the PROFIBUS token.

Table 78: LED states for the PROFIBUS MPI protocol – 1 Communication Status LED

LED State	Definition
On	The indicator is constantly on.
Off	The indicator is constantly off.
Blinking (5 Hz)	The indicator turns on and off with a frequency of appr. 5 Hz: “on” for appr. 100 ms, followed by “off” for appr. 100 ms.
Blinking (0.5 Hz)	The indicator turns on and off with a frequency of appr. 0.5 Hz: “on” for appr. 1000 ms, followed by “off” for appr. 1000 ms.

Table 79: LED state definitions for the PROFIBUS MPI protocol

## 8.18.2 2 Communication Status LEDs

For the PROFIBUS MPI protocol, the communication status LEDs **STA** and **ERR** can assume the states described below. This description is valid from stack version V2.4.





LED	Color	State	Meaning
<b>cifX with 2 Communication Status LEDs (AIFX-DP is connected)</b>			
<b>STA</b>	<b>LED green</b>		
	 (green)	On	<b>Status:</b> The device currently holds the PROFIBUS token and is able to transfer telegrams of data.
	 (green)	Blinking (5 Hz)	<b>Status:</b> The device is configured to be a part of the PROFIBUS ring, but it must share the PROFIBUS token with other PROFIBUS-Master devices present on the PROFIBUS ring.
	 (green)	Blinking (0.5 Hz)	<b>Status:</b> Automatic baudrate detection is running
	 (off)	Off	<b>Status:</b> The device has not been integrated into the PROFIBUS ring, i.e. it has not been configured correctly or has a wrong configuration or has not received the PROFIBUS token.
<b>ERR</b>	<b>LED red</b>		
	 (off)	Off	This LED is not used.

Table 80: LED states for the PROFIBUS MPI protocol – 2 Communication Status LEDs (AIFX-DP connected)

LED State	Definition
On	The indicator is constantly on.
Off	The indicator is constantly off.
Blinking (5 Hz)	The indicator turns on and off with a frequency of appr. 5 Hz: “on” for appr. 100 ms, followed by “off” for appr. 100 ms.
Blinking (0.5 Hz)	The indicator turns on and off with a frequency of appr. 0.5 Hz: “on” for appr. 1000 ms, followed by “off” for appr. 1000 ms.

Table 81: LED state definitions for the PROFIBUS MPI protocol

## 8.19 CANopen Master

### 8.19.1 1 Communication Status LED

For the CANopen Master protocol, the communication status LED **CAN** can assume the states described below. This description is valid from stack version V2.11.







LED	Color	State	Meaning
<b>cifX with 1 Communication Status LED</b> (current Hardware Revision)			
<b>CAN</b>	<b>Duo-LED red/green</b>		
	 (green)	On	<b>OPERATIONAL:</b> The device is in the OPERATIONAL state.
	 (green)	Blinking (2,5 Hz)	<b>PREOPERATIONAL:</b> The device is in the PREOPERATIONAL state.
	 (green)	Single flash	<b>STOPPED:</b> The device is in STOPPED state.
	 (red)	Single flash	<b>Warning Limit reached:</b> At least one of the error counters of the CAN controller has reached or exceeded the warning level (too many error frames).
	 (red)	Double flash	<b>Error Control Event:</b> A guard event (NMT Slave or NMT Master) or a heartbeat event (Heartbeat consumer) has occurred.
	 (red)	On	<b>Bus Off:</b> The CAN controller is in bus OFF state.
 (off)	Off	<b>RESET:</b> The device is executing a reset or the device has no configuration.	

Table 82: LED states for the CANopen Master protocol – 1 Communication Status LED (current Hardware Revision)

LED state	Definition
On	The indicator is constantly on.
Off	The indicator is constantly off.
Blinking (2,5 Hz)	The indicator turns on and off with a frequency of 2,5 Hz: “on” for 200 ms, followed by “off” for 200 ms.
Single flash	The indicator shows one short flash (200 ms) followed by a long “off” phase (1,000 ms).
Double flash	The indicator shows a sequence of two short flashes (each 200 ms), separated by a short “off” phase (200 ms). The sequence is finished by a long “off” phase (1,000 ms).

Table 83: LED state definitions for the CANopen Master protocol

## 8.19.2 2 Communication Status LEDs

For the CANopen Master protocol, the communication status LEDs **RUN** and **ERR** can assume the states described below. This description is valid from stack version V2.11.









LED	Color	State	Meaning
<b>cifX with 2 Communication Status LEDs</b> (AIFX-CO is connected or for prior Hardware Revisions)			
<b>RUN</b>	<b>LED green</b>		
	 (green)	On	<b>OPERATIONAL:</b> The device is in the OPERATIONAL state.
	 (green)	Blinking (2,5 Hz)	<b>PREOPERATIONAL:</b> The device is in the PREOPERATIONAL state.
	 (green)	Single flash	<b>STOPPED:</b> The device is in STOPPED state.
	 (off)	Off	<i>LED red is off:</i> <b>RESET:</b> The device is executing a reset or the device has no configuration. <i>LED red is flashing or "on":</i> Refer to description LED red.
<b>ERR</b>	<b>LED red</b>		
	 (off)	Off	Refer to description LED green.
	 (red)	Single flash	<b>Warning Limit reached:</b> At least one of the error counters of the CAN controller has reached or exceeded the warning level (too many error frames).
	 (red)	Double flash	<b>Error Control Event:</b> A guard event (NMT Slave or NMT Master) or a heartbeat event (Heartbeat consumer) has occurred.
	 (red)	On	<b>Bus Off:</b> The CAN controller is in bus OFF state.

Table 84: LED states for the CANopen Master protocol – 2 Communication Status LEDs (AIFX-CO connected or prior Hardware Revision)

LED state	Definition
On	The indicator is constantly on.
Off	The indicator is constantly off.
Blinking (2,5 Hz)	The indicator turns on and off with a frequency of 2,5 Hz: "on" for 200 ms, followed by "off" for 200 ms.
Single flash	The indicator shows one short flash (200 ms) followed by a long "off" phase (1,000 ms).
Double flash	The indicator shows a sequence of two short flashes (each 200 ms), separated by a short "off" phase (200 ms). The sequence is finished by a long "off" phase (1,000 ms).

Table 85: LED state definitions for the CANopen Master protocol

## 8.20 CANopen Slave

### 8.20.1 1 Communication Status LED

For the CANopen Slave protocol, the communication status LED **CAN** can assume the states described below. This description is valid from stack version V3.4.









LED	Color	State	Meaning
<b>cifX with 1 Communication Status LED</b> (current Hardware Revision)			
<b>CAN</b>	<b>Duo LED red/green</b>		
	 (green)	On	<b>OPERATIONAL:</b> The device is in the OPERATIONAL state.
	 (green)	Blinking (2.5 Hz)	<b>PREOPERATIONAL:</b> The device is in the PREOPERATIONAL state.
	 (green)	Single flash	<b>STOPPED:</b> The device is in STOPPED state.
	  (red/green)	Flickering (10 Hz)	<b>Auto Baud Rate Detection active:</b> The Device is in the auto baud rate detection mode.
	 (red)	Single flash	<b>Warning Limit reached:</b> At least one of the error counters of the CAN controller has reached or exceeded the warning level (too many error frames).
	 (red)	Double flash	<b>Error Control Event:</b> A guard event (NMT Slave or NMT Master) or a heartbeat event (Heartbeat consumer) has occurred.
	 (red)	On	<b>Bus Off:</b> The CAN controller is in bus OFF state.
 (off)	Off	<b>RESET:</b> The device is executing a reset or the device has no configuration.	

Table 86: States of the CAN LED for the CANopen Slave protocol – 1 Communication Status LED (current Hardware Revision)

LED State	Definition
On	The indicator is constantly on.
Off	The indicator is constantly off.
Flickering (10 Hz)	The indicator turns on and off with a frequency of 10 Hz: “on” for 50 ms, followed by “off” for 50 ms.
Blinking (2.5 Hz)	The indicator turns on and off with a frequency of 2,5 Hz: “on” for 200 ms, followed by “off” for 200 ms.
Single Flash	The indicator shows one short flash (200 ms) followed by a long “off” phase (1,000 ms).
Double Flash	The indicator shows a sequence of two short flashes (each 200 ms), separated by a short off phase (200 ms). The sequence is finished by a long “off” phase (1,000 ms).

Table 87: LED state definitions for the CANopen Slave protocol

## 8.20.2 2 Communication Status LEDs

For the CANopen Slave protocol, the communication status LEDs **RUN** and **ERR** can assume the states described below. This description is valid from stack version V3.4.











LED	Color	State	Meaning
<b>cifX with 2 Communication Status LEDs</b> (AIFX-CO is connected or for prior Hardware Revisions)			
<b>RUN</b>	<b>LED green</b>		
	 (green)	On	<b>OPERATIONAL:</b> The device is in the OPERATIONAL state.
	 (green)	Blinking (2.5 Hz)	<b>PREOPERATIONAL:</b> The device is in the PREOPERATIONAL state.
	 (green)	Single flash	<b>STOPPED:</b> The device is in STOPPED state.
	 (green)	Flickering (10 Hz, alternatively with ERR LED)	<b>Auto Baud Rate Detection active:</b> The Device is in the auto baud rate detection mode.
	 (off)	Off	<i>LED red is off:</i> <b>RESET:</b> The device is executing a reset or the device has no configuration. <i>LED red is flickering, flashes or "on":</i> Refer to description LED red.
<b>ERR</b>	<b>LED red</b>		
	 (off)	Off	Refer to description LED green.
	 (red)	Flickering (10 Hz, alternatively with RUN LED)	<b>Auto Baud Rate Detection active:</b> The Device is in the auto baud rate detection mode.
	 (red)	Single flash	<b>Warning Limit reached:</b> At least one of the error counters of the CAN controller has reached or exceeded the warning level (too many error frames).
	 (red)	Double flash	<b>Error Control Event:</b> A guard event (NMT Slave or NMT Master) or a heartbeat event (Heartbeat consumer) has occurred.
	 (red)	On	<b>Bus Off:</b> The CAN controller is in bus OFF state.

Table 88: States of the CAN LED for the CANopen Slave protocol – 2 Communication Status LEDs (AIFX-CO connected or prior Hardware Revision)

LED State	Definition
On	The indicator is constantly on.
Off	The indicator is constantly off.
Flickering (10 Hz)	The indicator turns on and off with a frequency of 10 Hz: "on" for 50 ms, followed by "off" for 50 ms.
Blinking (2.5 Hz)	The indicator turns on and off with a frequency of 2,5 Hz: "on" for 200 ms, followed by "off" for 200 ms.
Single Flash	The indicator shows one short flash (200 ms) followed by a long "off" phase (1,000 ms).
Double Flash	The indicator shows a sequence of two short flashes (each 200 ms), separated by a short off phase (200 ms). The sequence is finished by a long "off" phase (1,000 ms).

Table 89: LED state definitions for the CANopen Slave protocol

## 8.21 DeviceNet Master

For the DeviceNet Master protocol, the communication status LED **MNS** can assume the states described below. This description is valid from stack version V2.3.







LED	Color	State	Meaning
<b>MNS</b>	<b>Duo LED red/green</b>		
	 (green)	On	<b>Device operational AND on-line, connected</b> Device is online and has established all connections with all Slaves.
	 (green)	Flashing (1 Hz)	<b>Device operational AND on-line</b> Device is online and has established no connection in the established state. - Configuration missing, incomplete or incorrect.
	 (green/red/Off)	Flashing (2Hz) Green/Red/Off	<b>Self test after power on</b>
	 (red)	Flashing (1 Hz)	<b>Minor fault and/or connection time-out</b> Device is online and has established one or more connections in the established state. It has data exchange with at least one of the configured Slaves. Minor or recoverable fault: No data exchange with one of the configured Slaves. One or more Slaves are not connected. Connection timeout Minor or recoverable fault: No data exchange with one of the configured Slaves. One or more Slaves are not connected. Connection timeout. No network power present.
	 (red)	On	<b>Critical fault or critical link failure</b> Critical connection failure; device has detected a network error: duplicate MAC-ID or severe error in CAN network (CAN-bus off).
 (off)	Off	<b>Device is not powered</b> - The device may not be powered. <b>Device is not on-line and/or no network power</b> - The device has not yet completed the Dup_MAC_ID test. - The device is powered, but the network power is missing.	

Table 90: LED states for the DeviceNet Master protocol

LED state	Definition
On	The indicator is constantly on.
Off	The indicator is constantly off.
Flashing (1 Hz)	The indicator turns on and off with a frequency of appr. 1 Hz: on for appr. 500 ms, followed by off for appr. 500 ms.
Flashing (2 Hz) green/red/off	The indicator turns on green on for 250 ms, then red on for 250 ms, then off.

Table 91: LED state definitions for the DeviceNet Master protocol



## 8.22 DeviceNet Slave

For the DeviceNet Slave protocol, the communication status LED **MNS** can assume the states described below. This description is valid from stack version V2.3.







LED	Color	State	Meaning
<b>MNS</b>	<b>Duo LED red/green</b>		
	 (green)	On	<b>Device operational AND on-line, connected</b> Device is online and has established all connections with all Slaves.
	 (green)	Flashing (1 Hz)	<b>Device operational AND on-line</b> Device is online and has established no connection in the established state. - Configuration missing, incomplete or incorrect.
	 (green/red/Off)	Flashing (2Hz) Green/Red/Off	<b>Self test after power on</b>
	 (red)	Flashing (1 Hz)	<b>Minor fault and/or connection time-out</b> Device has no connectin to the Master. Minor or recoverable fault: No data exchange with the Master. Connection timeout. No network power present.
	 (red)	On	<b>Critical fault or critical link failure</b> Critical connection failure; device has detected a network error: duplicate MAC-ID or severe error in CAN network (CAN-bus off).
	 (off)	Off	<b>Device is not powered</b> - The device may not be powered. <b>Device is not on-line and/or no network power</b> - The device has not yet completed the Dup_MAC_ID test. - The device is powered, but the network power is missing.

Table 92: LED states for the DeviceNet Slave protocol

LED state	Definition
On	The indicator is constantly on.
Off	The indicator is constantly off.
Flashing (1 Hz)	The indicator turns on and off with a frequency of appr. 1 Hz: on for appr. 500 ms, followed by off for appr. 500 ms.
Flashing (2 Hz) green/red/off	The indicator turns on green on for 250 ms, then red on for 250 ms, then off.

Table 93: LED state definitions for the DeviceNet Slave protocol

## 8.23 CC-Link Slave

### 8.24 Slave

For the CC-Link Slave protocol, the communication status LEDs **L-RUN** and **L-ERR** can assume the states described below. This description is valid from stack version V2.9.





LED	Color	State	Meaning
<b>L RUN</b>	<b>LED green</b>		
	 (green)	On	After participating in the network, the device receives both refresh and polling signals or just the refresh signal normally.
	 (off)	Off	<ol style="list-style-type: none"> <li>1. Before participating in the network</li> <li>2. Unable to detect carrier</li> <li>3. Timeout</li> <li>4. Resetting hardware</li> </ol>
<b>L ERR</b>	<b>LED red</b>		
	 (red)	Blinking	The switch setting has been changed from the setting at the reset cancellation (blinks for 0.4 sec.).
	 (red)	On	<ol style="list-style-type: none"> <li>1. CRC error</li> <li>2. Address parameter error (0,65 or greater is set including the number of occupied stations)</li> <li>3. Baud rate switch setting error during cancellation of reset (5 or greater)</li> </ol>
	 (off)	Off	<ol style="list-style-type: none"> <li>1. Normal communication</li> <li>2. Resetting hardware</li> </ol>

Table 94: LED states for the CC-Link Slave protocol

LED state	Definition
On	The indicator is constantly on.
Off	The indicator is constantly off.
Blinking	The indicator turns on and off cyclically.

Table 95: LED state definitions for the CC-Link Slave protocol

# 9 Device Connections and Switches

## 9.1 Ethernet Interface

For the Ethernet interface use RJ45 plugs and twisted pair cable of category 5 (CAT5) or higher, which consists of 4 twisted cores and has a maximum transmission rate of 100 MBit/s (CAT5).

### 9.1.1 Ethernet Pin Assignment at the RJ45 Socket



**Note:** The device supports the **Auto Crossover** function. Due to this fact RX and TX can be switched. The following figure shows the RJ45 standard pin assignment.

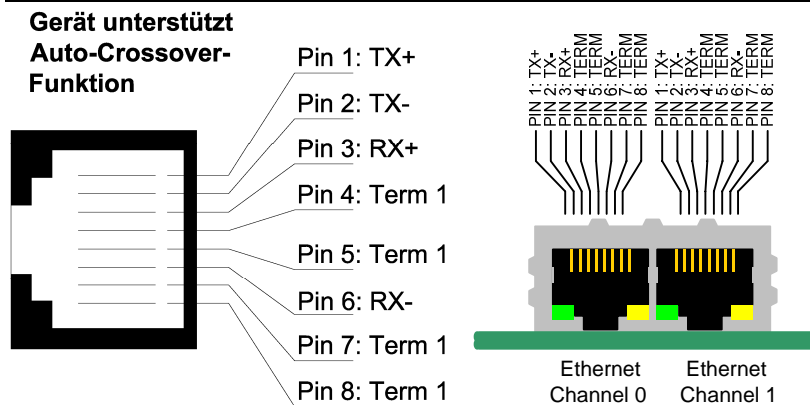

Figure 55: Ethernet Pin Assignment at the RJ45 Socket for cifX or AIFX

Pin	Signal	Meaning
1	TX+	Transmit Data +
2	TX-	Transmit Data -
3	RX+	Receive Data +
4	Term 1	Connected to each other and terminated to PE through RC circuit*
5	Term 1	
6	RX-	Receive Data -
7	Term 2	Connected to each other and terminated to PE through RC circuit*
8	Term 2	
		* Bob Smith Termination

Table 96: Ethernet Pin Assignment at the RJ45 Socket for cifX or AIFX



**Further Notes:**

- (1) The RJ45 socket is only for use in LAN, not for telecommunication circuits.
- (2) With loaded EtherCAT Master firmware only the RJ45 channel 0 can be used, channel 1 is deactivated. Beginning with the EtherCAT Master firmware version 3 channel 1 can be reactivated if redundancy is activated. For the Open Modbus/TCP firmware with V2.3.4.0 and higher both RJ45 RJ45channels can be used.

## 9.1.2 Ethernet Connection Data

<b>Medium</b>	2 x 2 Twisted-Pair cupric cable, CAT5 (100 MBit/s)
<b>Length of cable</b>	Typ. 100 m
<b>Transmission rate</b>	10 MBit/s/100 MBit/s

Table 97: Ethernet Connection Data

## 9.1.3 Use of Hubs and Switches

For the corresponding communication systems, the use of hubs and/or switches is either forbidden or allowed. The following table shows the acceptable use of hubs and switches by each communication system:

Communication System	Hub	Switch
<b>EtherCAT</b>	forbidden	only allowed between EtherCAT Master and first EtherCAT Slave (100 MBit/s, Full Duplex)
<b>EtherNet/IP</b>	allowed	allowed (10 MBit/s/100 MBit/s, Full or Half Duplex, Auto-Negotiation)
<b>Open Modbus/TCP</b>	allowed	allowed (10 MBit/s/100 MBit/s, Full or Half Duplex, Auto-Negotiation)
<b>POWELINK</b>	allowed	forbidden
<b>PROFINET IO</b>	forbidden	Only allowed if the switch supports 'Priority Tagging' and LLDP (100 MBit/s, Full Duplex)
<b>sercos</b>	forbidden	forbidden
<b>VARAN*</b>	forbidden	forbidden

Table 98: Use of Hubs and Switches

\*Instead of hubs and switches VARAN uses splitter. [3]

## 9.2 PROFIBUS Interface

Isolated RS-485 interface:

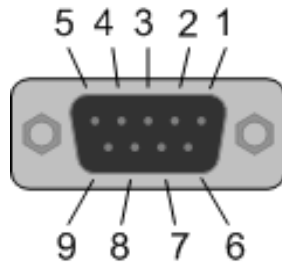

Figure 56: PROFIBUS Interface (DSub female connector, 9 pin), X400

Connection with DSub female connector	Signal	Meaning
3	RxD/TxD-P	Receive/Send Data-P respectively connection B plug
5	DGND	Reference potential
6	VP	Positive supply voltage
8	RxD/TxD-N	Receive/Send Data-N respectively connection A plug

Table 99: PROFIBUS Interface, X400

## 9.3 CANopen Interface

Isolated ISO 11898 interface:

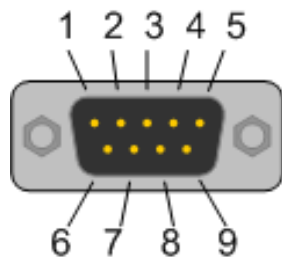

Figure 57: CANopen Interface (DSub male connector, 9 pin), X400

Connection with DSub male connector	Signal	Description
2	CAN_L	CAN_Low Bus Line
3	CAN_GND	CAN Ground
7	CAN_H	CAN High Bus Line
1, 4, 5, 6, 8, 9		<b>Do not connect!</b>

Table 100: CANopen Interface, X400

## 9.4 DeviceNet Interface

Isolated ISO 11898 interface:

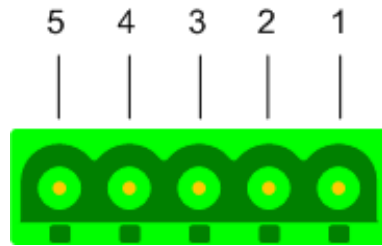

Figure 58: DeviceNet Interface (CombiCon male Connector, 5 pin), X360

Connection with CombiCon male connector	Signal	Color	Description
1	V-	Black	Reference potential DeviceNet supply voltage
2	CAN_L	Blue	CAN Low-Signal
3	Drain		Shield
4	CAN_H	White	CAN High-Signal
5	V+	Red	+24 V DeviceNet supply voltage

Table 101: DeviceNet Interface, X360

## 9.5 CC-Link Interface

Isolated RS-485 interface:

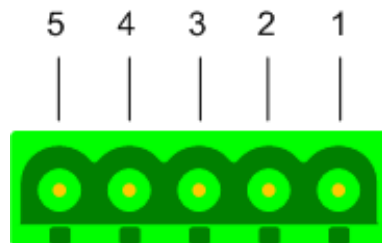

Figure 59: CC-Link Interface (CombiCon male Connector, 5 pin)

Connection with Screw terminal Connector	Signal	Meaning
1	DA	Data A
2	DB	Data B
3	DG	Data Ground
4	SLD	Shield
5	FG	Field Ground

Table 102: CC-Link Interface

## 9.6 Mini-B USB Connector (5 Pin)

The Mini-B USB connector is provided for the following PC cards cifX:  
 CIFX 80-RE, CIFX 80-DP, CIFX 80-CO, CIFX 80-DN,  
 CIFX 104C-RE, CIFX 104C-DP, CIFX 104C-CO, CIFX 104C-DN,  
 CIFX 104C-RE-R, CIFX 104C-DP-R, CIFX 104C-CO-R, CIFX 104C-DN-R

In addition a Mini-B USB connector will be available for the following PC cards cifX if the AIFX-DIAG is connected to the PC card cifX:  
 CIFX 104C-RE\F\*, CIFX 104C-DP\F, CIFX 104C-CO\F, CIFX 104C-DN\F, CIFX 104C-CC\F,  
 CIFX 104C-RE-R\F\*, CIFX 104C-DP-R\F, CIFX 104C-CO-R\F, CIFX 104C-DN-R\F



**Note!** \*From the hardware revision 5 of the PC cards CIFX 104C-RE\F and CIFX 104C-RE-R\F if the diagnostic **AIFX-DIAG** assembly interface is connected, the **Mini-B USB** connector on the AIFX-DIAG can be used.

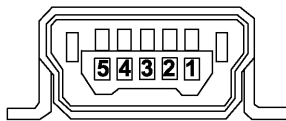

Figure 60: Mini-B USB Connector (5 Pin)

Pin	Name	Description
1	USB_EXT	USB Bus Power (+5 V dc, supplied externally)
2	D-	Data -
3	D+	Data +
4	ID	Not connected
5	GND	Ground

Table 103: Pin Assignment Mini-B USB Connector

## 9.7 Rotary Switch for PCI-104 Slot Number

Only for CIFX 104C cards.

The **Rotary Switch for PCI-104 Slot Number** is used for setting the physical PCI-104 Slot Number. At maximum four CIFX 104C cards can be plugged as modules one upon the other and each switch position must be used only once. The module plugged next to the host controller gets the CLK number 0, the following modules respectively get the next higher CLK number.

Switch Position	Module No. PCI-104 Slot	CLK No. (Clock)	ID-Select	INT
0, 4, 8	1	CLK 0	IDSEL 0	INTA
1, 5, 9	2	CLK 1	IDSEL 1	INTB
2, 6	3	CLK 2	IDSEL 2	INTC
3, 7	4	CLK 3	IDSEL 3	INTD

Table 104: Rotary Switch for PCI-104 Slot Number, S1

## 9.8 Rotary Switch Device Address

The **Rotary Switch Device Address** at the PC cards  
 CIFX 104C-RE, CIFX 104C-RE-R, CIFX 104C-RE\F, CIFX 104C-RE-R\F;  
 CIFX 104C-DP, CIFX 104C-DP-R, CIFX 104C-DP\F, CIFX 104C-DP-R\F,  
 CIFX 104C-CO, CIFX 104C-CO-R, CIFX 104C-CO\F, CIFX 104C-CO-R\F,  
 CIFX 104C-DN, CIFX 104C-DN-R, CIFX 104C-DN\F, CIFX 104C-DN-R\F, CIFX 104-CC/F  
 currently is unassigned. The Slave address setting is done via the configuration software.

## 9.9 Cable Connector

### 9.9.1 Pin Assignment for Cable Connector Ethernet

Only for  
 CIFS 90-RE\F (X4),  
 CIFS 90E-RE\F, CIFS 90E-RE\ET\F,  
 CIFS 90E-RE\MR\F, CIFS 90E-RE\MR\ET\F (X4),  
 CIFS 104C-RE\F (X304), CIFS 104C-RE-R\F (X4).

Pin Assignment for Cable Connector Ethernet X4 or X304 - Cable 20 pin Ethernet and Status LEDs:

Pin	Signal	Pin	Signal
1	GND	11	CH0_TXP
2	+3V3 Analog	12	CH0_TXN
3	STA0_green (RE LED COM 0)	13	CH0_RXP
4	STA0_red (RE LED COM 0)	14	CH0_RXN
5	XM0_TX	15	CH1_TXP
6	STA1_green (RE LED COM 1)	16	CH1_TXN
7	CH0_LINKn	17	CH1_RXP
8	CH0_ACTIVITY	18	CH1_RXN
9	AIFINIT	19	CH1_LINKn
10	STA1_red (RE LED COM 1)	20	CH1_ACTIVITY

Table 105: Pin Assignment for Cable Connector Ethernet X4 or X304

#### Cable Connector Ethernet:

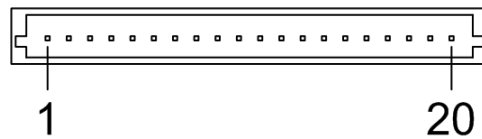

Figure 61: 1x20 Pins for CIFS 104C-RE\F, CIFS 104C-RE-R\F, CIFS 90-RE\F or CIFS 90-RE\ET\F

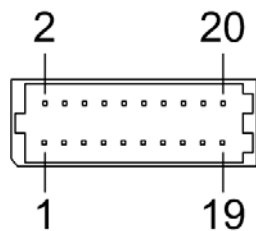

Figure 62: 2x20 Pins for CIFS 90E-RE\F, CIFS 90E-RE\ET\F, CIFS 90E-RE\MR\F or CIFS 90E-RE\MR\ET\F



### 9.9.2 Pin Assignment for Cable Connector Fieldbus X3, X304, X4

Only for  
 CIFS 90-DP\F, CIFS 90-CO\F, CIFS 90-DN\F (X3) and  
 CIFS 90E-DP\F, CIFS 90E-CO\F, CIFS 90E-DN\F, ,  
 CIFS 90E-DP\ET\F, CIFS 90E-CO\ET\F, CIFS 90E-DN\ET\F,  
 CIFS 90E-DP\MR\F, CIFS 90E-CO\MR\F, CIFS 90E-DN\MR\F,  
 CIFS 90E-DP\MR\ET\F, CIFS 90E-CO\MR\ET\F, CIFS 90E-DN\MR\ET\F (X3)  
 CIFS 104C-DP\F, CIFS 104C-CO\F, CIFS 104C-DN\F,  
 CIFS 104C-CC\F: (X304);  
 CIFS 104C-DP-R\F, CIFS 104C-CO-R\F, CIFS 104C-DN-R\F: (X4).

Pin Assignment for cable connector fieldbus X3, X304 or X4,  
 Cable 10 pin Fieldbus:

Pin	Signal
1	GND
2	+3V3 Analog
3	I2C_CLK/PIO 4
4	I2C_DATA/ PIO 5
5	XMAC2_TX
6	XMAC2_RX
7	XMAC2_IO0
8	XMAC2_IO1
9	/RSTOUT
10	(not used)

Table 106: Pin Assignment for Cable Connector Fieldbus X3, X304 or X4

### 9.9.3 Pin Assignment for Cable Connector Fieldbus X3 and X4 for 2 Channel Devices

Only for  
 CIFS 90E-2DP\ET\F, CIFS 90E-2DP\MR\ET\F  
 CIFS 90E-2DP\CO\ET\F, CIFS 90E-2DP\CO\MR\ET\F  
 CIFS 90E-2DP\DN\ET\F, CIFS 90E-2DP\DN\MR\ET\F  
 CIFS 90E-2CO\ET\F, CIFS 90E-2CO\MR\ET\F  
 CIFS 90E-2CO\DN\ET\F, CIFS 90E-2CO\DN\MR\ET\F  
 CIFS 90E-2DN\ET\F, CIFS 90E-2DN\MR\ET\F (X3 and X4)

Pin Assignment for cable connector fieldbus X3 and X4 for 2 channel  
 devices, cable 10 pin fieldbus:

Cable Connector Fieldbus X3		Cable Connector Fieldbus X4	
Pin	Signal	Pin	Signal
1	GND	1	GND
2	+3V3 Analog	2	+3V3 Analog
3	I2C_CLK/PIO 4	3	I2C_CLK/PIO 6
4	I2C_DATA/ PIO 5	4	I2C_DATA/ PIO 7
5	XMAC2_TX	5	XMAC3_TX
6	XMAC2_RX	6	XMAC3_RX
7	XMAC2_IO0	7	XMAC3_IO0
8	XMAC2_IO1	8	XMAC3_IO1
9	/RSTOUT	9	/RSTOUT
10	(nicht verwendet)	1	(nicht verwendet)

Table 107: Pin Assignment for Cable Connector Fieldbus X3 and X4 for 2 Channel Devices

## 9.9.4 Pin Assignment for Cable Connector DIAG

Only for

CIFX 104C-RE\F (X303), CIFX 104C-RE-R\F (X3),

CIFX 104C-DP\F, CIFX 104C-CO\F, CIFX 104C-DN\F,

CIFX 104C-CC\F: (X303)

Pin Assignment for Cable connector DIAG X3 or X303 -  
Cable 12 pin USB + Status LEDs

Pin	Signal (Feldbus)	Signal (Ethernet)
1	GND	GND
2	+3V3	+3V3
3	STA2 (FB LED COM 0)	STA2 (not used)
4	STA3 (FB LED COM 1)	STA3 (not used)
5	USB_POS	USB_POS
6	USB_NEG	USB_NEG
7	RDYn	RDYn
8	RUNn	RUNn
9	STA0_green (not used)	STA0_green (RE LED COM 0)
10	STA0_red (not used)	STA0_red (RE LED COM 0)
11	STA1_green (not used)	STA1_green (RE LED COM 1)
12	STA1_red (not used)	STA1_red (RE LED COM 1)

Table 108: Pin Assignment for Cable connector DIAG X3 or X303

## 9.10 SYNC Connector (Pin-Assignment, Hardware/Firmware)

### 9.10.1 Pin Assignment SYNC Connector, X51 (CIFX 80 90 104C)

Only for CIFX 80-RE, CIFX 90-RE\F, CIFX 104C-RE, CIFX 104C-RE-R, CIFX 104C-RE\F, CIFX 104C-RE-R\F.

Pin	Signal
1	GND
2	IO_SYNC0
3	IO_SYNC1

Table 109: Pin Assignment for SYNC Connector, X51

CIFX 90E-RE\F, CIFX 90E-RE\ET\F, CIFX 90E-RE\MR\F and CIFX 90E-RE\MR\ET\F: The SYNC pins are on the Mini PCI Express bus (Pin 46, 44), refer to section *Pin Assignment for Mini PCI Express Bus / SYNC Connector (Bootstart)*, X1/X2, on page 135.

### 9.10.2 Items on Hardware

Item	Explanation
SYNC Signal	3.3 V (LVTTTL), maximum load 6 mA
Connector	SYNC connector, X51 (for the PC cards cifX, as indicated under section <i>Pin Assignment SYNC Connector, X51</i> on page 131.) Female connector, 3 pin, pitch spacing 1.25 mm (for example, the type Molex series 51021) and female crimp contacts in design (e. g. type Molex series 50079/50058)
Max. Cable Length	Recommendation: Max. 50 mm <b>Note:</b> Take EMC into consideration for the cable laying

Table 110: SYNC Connector: SYNC Signal, Connector, Max. Cable Length

### 9.10.3 Items on Firmware

The loaded firmware determines if the signal is an input signal or output signal. The following table shows the meaning of the SYNC signals for the real-time Ethernet protocols currently offering SYNC signal support.

Protocol	Signal IO_SYNC0 Input/Output	Signal IO_SYNC1 Input/Output	From Firmware Version	Remarks
EtherCAT Slave	SYNC 0 Output	SYNC 1 Output	-	Configurable
PROFINET IO Device	Bus cycle start (PROFINET IRT) Output	-	3.4.x.x	-
sercos III Master	External trigger to start bus cycle Input Rising edge	-	2.0.8.0	-
sercos III Slave	CON_CLK Output	DIV_CLK Output	3.0.10.0	Configurable

Table 111: Meaning of the SYNC Signals for each Protocol



## 9.11.2 References PCI Specifications

No.	Specification	Revision	Version	De	www
[bus spec 2]	PCI Express® Base Specification	2.0	-	January 15, 2007	pcisig.com
[bus spec 4]	CompactPCI™ Specification Short Form	2.1	2.0	September 2, 1997	picmg.org
[bus spec 5]	Mini PCI Specification	1.0	-	Oct, 25th 1999	pcisig.com
[bus spec 6]	PCI Express Mini Card Electromechanical Specification	1.1	-	March 28, 2005	
		1.2	-	October 26, 2007	
		2.0	-	April 21, 2012	
[bus spec 7]	PCI-104 Specification		1.0	November 2003	

Table 113: References PCI Specifications

## 9.11.3 Pin Assignment for Mini PCI Bus, X1

Only for: C1FX 90-RE\F, C1FX 90-DP\F, C1FX 90-CO\F, C1FX 90-DN\F, C1FX 90-CC\F (X1)

Pin (Top)	Signal	Pin (Bottom)	Signal
1	(not used)	2	(not used)
	Key		Key
3	(not used)	4	(not used)
5	(not used)	6	(not used)
7	(not used)	8	(not used)
9	(not used)	10	(not used)
11	(not used)	12	(not used)
13	(not used)	14	(not used)
15	(not used)	16	(not used)
17	(not used)	18	(not used)
19	3.3V	20	INTA#
21	(not used)	22	(not used)
23	GROUND	24	(not used)
25	CLK	26	RST#
27	GROUND	28	VIO: 3.3V or 5 V, depends on signal voltage
29	REQ#	30	GNT#
31	3.3V	32	GROUND
33	AD[31]	34	(not used)
35	AD[29]	36	(not used)
37	GROUND	38	AD[30]
39	AD[27]	40	3.3V
41	AD[25]	42	AD[28]
43	(not used)	44	AD[26]
45	C/BE[3]#	46	AD[24]
47	AD[23]	48	IDSEL
49	GROUND	50	GROUND
51	AD[21]	52	AD[22]
53	AD[19]	54	AD[20]
55	GROUND	56	PAR
57	AD[17]	58	AD[18]

Pin (Top)	Signal	Pin (Bottom)	Signal
59	C/BE[2]#	60	AD[16]
61	IRDY#	62	GROUND
63	3.3V	64	FRAME#
65	CLKRUN#	66	TRDY#
67	SERR#	68	STOP#
69	GROUND	70	3.3V
71	PERR#	72	DEVSEL#
73	C/BE[1]#	74	GROUND
75	AD[14]	76	AD[15]
77	GROUND	78	AD[13]
79	AD[12]	80	AD[11]
81	AD[10]	82	GROUND
83	GROUND	84	AD[09]
85	AD[08]	86	C/BE[0]#
87	AD[07]	88	(not used)
89	3.3V	90	AD[06]
91	AD[05]	92	AD[04]
93	(not used)	94	AD[02]
95	AD[03]	96	AD[00]
97	(not used)	98	(not used)
99	AD[01]	100	(not used)
101	GROUND	102	GROUND
103	(not used)	104	(not used)
105	(not used)	106	(not used)
107	(not used)	108	(not used)
109	(not used)	110	(not used)
111	(not used)	112	(not used)
113	(not used)	114	GROUND
115	(not used)	116	(not used)
117	(not used)	118	(not used)
119	(not used)	120	(not used)
121	(not used)	122	MPCIACT#, over 120 $\Omega$ to GROUND
123	(not used)	124	(not used)

Table 114: Pin Assignment for Mini PCI Bus, X1

The pin assignment described in *Table 114* originates from the standard pin assignment for Mini PCI Connector III [bus spec 4, page 14] (refer to section *References PCI Specifications* on page 133).

### 9.11.4 Pin Assignment for Mini PCI Express Bus / SYNC Connector (Bootstart), X1/X2

Only for Hardware Revision B:

CIFX 90E-RE\F\*, CIFX 90E-DP\F, CIFX 90E-CO\F, CIFX 90E-DN\F,  
CIFX 90E-RE\MR\F\*, CIFX 90E-DP\MR\F, CIFX 90E-CO\MR\F, CIFX 90E-DN\MR\F,

And for Hardware Revision 1:

CIFX 90E-RE\F\*, CIFX 90E-DP\F, CIFX 90E-CO\F, CIFX 90E-DN\F,  
CIFX 90E-RE\MR\F\*, CIFX 90E-DP\MR\F, CIFX 90E-CO\MR\F, CIFX 90E-DN\MR\F,  
CIFX 90E-CC\F, CIFX 90E-RE\MR\F\*, CIFX 90E-DP\MR\F, CIFX 90E-CO\MR\F, CIFX 90E-DN\MR\F, CIFX 90E-CC\MR\F

\*The SYNC connection is realized via the mini PCI Express bus.

Pin (X1)	Signal	Pin (X2)	Signal
51	(not used)	52	+3.3V
49	(not used)	50	GND
47	(not used)	48	(not used)
45	(not used)	46	IO_SYNC0 (not used with fieldbus protocols)
43	GND	44	IO_SYNC1 (not used with fieldbus protocols)
41	+3.3V	42	Bootstart
39	(not used)	40	GND
37	GND	38	USB_D+ (disabled – not used)
35	GND	36	USB_D - (disabled – not used)
33	PERp0 <sup>7</sup>	34	GND
31	PERn0 <sup>7</sup>	32	(not used)
29	GND	30	(not used)
27	GND	28	(not used)
25	PETp0 <sup>7</sup>	26	GND
23	PETn0 <sup>7</sup>	24	(not used)
21	GND	22	PERST#
19	(not used)	20	(not used)
17	(not used)	18	GND
15	GND	16	(not used)
13	REFCLK+	14	(not used)
11	REFCLK-	12	(not used)
9	GND	10	(not used)
7	CLKREQ#	8	(not used)
5	(not used)	6	(not used)
3	(not used)	4	GND
1	(not used)	2	3.3V

Table 115: Pin Assignment Mini PCI Express Bus / SYNC Connector, X1/X2

Unless otherwise noted, the pin assignment for Mini PCI Express bus, X1/X2 described in Table 115 corresponds to the bus specification for Mini PCI Express [bus spec 6, Rev. 1.2, Section 3.3].



**Note!** Please note the following characteristics for the pin assignment of the Mini PCI Express Bus, X1/X2, described in Table 115:

- The Pins 6, 28, 48 and Pin 24 are 'not used'.
- The Pins 36 and 38 are 'not used'.
- The pin assignment of the Pins 42, 44, 46 deviates from the standard specification Mini PCI Express.

<sup>7</sup> The names of the pins 33 and 31 with PER (,R' for ,Receive') and of the pins 25 and 23 with PET ('T' for ,Transmit') are defined in the view of the PC card cifX. The names in the bus specification are defined from the perspective of the host.



For the reference for [bus spec 6] for the bus specification for Mini PCI Express refer to section *References PCI Specifications* on page 133 of this manual.

About earlier Hardware Revisions refer to section *Notes on earlier Hardware Revisions* from page 234.

### **Pins 6, 28, 48**

For the PC cards CIFX 90E-XX\F (alle variants 'MR' or 'ET')<sup>8</sup> the **Pins 6, 28, 48** are '**not used**', as listed in the *Table 115* on page 135.

### **Pin 24**

For the PC cards CIFX 90E-XX\F (all variants 'MR' or 'ET') the **Pin 24** is '**not used**'.



**Note:** Due to how **pin 24** is used, the PC cards CIFX 90E-XX\F (all variants 'MR' or 'ET') can be used together with main boards according to any earlier revision (1.1 and 1.2) of the Mini PCI Express specification [bus spec 6], as well as to the latest revision (2.0).

### **Pins 36 and 38 (USB Connector)**

The USB connector at the Mini PCI Express Bus of the PC cards CIFX 90E-XX\F (all variants 'MR' or 'ET') is directly connected to the CPU of the PC and is not used for external diagnosis.

- The **Pins 36** and **38** are disabled and are '**not used**'. When you start the PC, the operating system does not ask for an USB driver.

### **Pin 42 (Bootstart) and 44 , 46 (SYNC)**

- **Pin 42 (Bootstart):** For all PC cards CIFX 90E-XX\F (all variants 'MR' or 'ET') **pin 42** is used for **Bootstart**.
- **Pins 44 , 46 (SYNC):** For the PC cards CIFX 90E-RE\F (all Real-Time Ethernet variants 'MR' or 'ET') depending by the protocol the **SYNC connection** is realized via the **pins 44 and 46** of the mini PCI Express bus. For further information to the SYNC pins (Pin 46, 44) refer to section *SYNC Connector (Pin-Assignment, Hardware/Firmware)* on page 131.

According to the bus specification for Mini PCI Express [bus spec 6] the pins are used to realize the LED status (Pin 42 „WWAN#“, Pin 44 „WLAN#“, Pin 46 „WPAN#“).

<sup>8</sup> Variants of the PC card CIFX 90E-XX\F: CIFX 90E-XX\ET\F, CIFX 90E-XX\MR\F or CIFX 90E-XX\MR\ET\F (XX = RE, DP, CO, DN or CC)



## 9.11.5 Pin Assignment for Mini PCI Express Bus, X1/X2 for 2 Channel Devices

Only for

CIFX 90E-2DP\ET\F, CIFX 90E-2DP\MR\ET\F  
 CIFX 90E-2DP\CO\ET\F, CIFX 90E-2DP\CO\MR\ET\F  
 CIFX 90E-2DP\DN\ET\F, CIFX 90E-2DP\DN\MR\ET\F  
 CIFX 90E-2CO\ET\F, CIFX 90E-2CO\MR\ET\F  
 CIFX 90E-2CO\DN\ET\F, CIFX 90E-2CO\DN\MR\ET\F  
 CIFX 90E-2DN\ET\F, CIFX 90E-2DN\MR\ET\F (X3 and X4)

### Pin Assignment Mini PCI Express Bus, X1/X2 for 2 Channel Devices

Pin (X1)	Signal	Pin (X2)	Signal
51	(not used)	52	+3.3V
49	(not used)	50	GND
47	(not used)	<b>48</b>	<b>(not used)</b>
45	(not used)	<b>46</b>	<b>(not used)</b>
43	GND	<b>44</b>	<b>(not used)</b>
41	+3.3V	<b>42</b>	<b>Bootstart</b>
39	(not used)	40	GND
37	GND	38	USB_D+ ( <i>disabled – not used</i> )
35	GND	36	USB_D- ( <i>disabled – not used</i> )
33	PERp0 <sup>7</sup>	34	GND
31	PERn0 <sup>7</sup>	32	(not used)
29	GND	30	(not used)
27	GND	<b>28</b>	<b>(not used)</b>
25	PETp0 <sup>7</sup>	26	GND
23	PETn0 <sup>7</sup>	<b>24</b>	<b>(not used)</b>
21	GND	22	PERST#
19	(not used)	20	(not used)
17	(not used)	18	GND
15	GND	16	(not used)
13	REFCLK+	14	(not used)
11	REFCLK-	12	(not used)
9	GND	10	(not used)
7	CLKREQ#	8	(not used)
5	(not used)	<b>6</b>	<b>(not used)</b>
3	(not used)	4	GND
1	(not used)	2	3.3V

Table 116: Pin Assignment Mini PCI Express Bus, X1/X2 for 2 Channel Devices

Unless otherwise noted, the pin assignment for Mini PCI Express bus, X1/X2 described in *Table 116* corresponds to the bus specification for Mini PCI Express [bus spec 6, Rev. 1.2, Section 3.3].



**Note!** Please note the following characteristics for the pin assignment of the Mini PCI Express Bus, X1/X2, described in *Table 116*:

- The **Pins 6, 28, 48** and **Pin 24** are '**not used**'.
- The **Pins 36** and **38** are '**not used**'.
- The pin assignment of the **Pin 42** deviates from the standard specification Mini PCI Express. The **Pins 44** and **46** are '**not used**'.



For the reference for [bus spec 6] for the bus specification for Mini PCI Express refer to section *References PCI Specifications* on page 133 of this manual.

---

### **Pins 6, 28, 48**

For the PC cards CIFX 90E-2FB\ET\F or CIFX 90E-2FB\MR\ET\F the **Pins 6, 28, 48** are '**not used**', as listed in the *Table 116* on page 137.

### **Pin 24**

For the PC cards CIFX 90E-2FB\ET\F or CIFX 90E-2FB\MR\ET\F the **Pin 24** is '**not used**'.



**Note:** Due to how **pin 24** is used, the PC cards CIFX 90E-2FB\ET\F or CIFX 90E-2FB\MR\ET\F can be used together with main boards according to any earlier revision (1.1 and 1.2) of the Mini PCI Express specification [bus spec 6], as well as to the latest revision (2.0).

---

### **Pins 36 and 38 (USB Connector)**

The USB connector at the Mini PCI Express Bus of the PC cards CIFX 90E-2FB\ET\F or CIFX 90E-2FB\MR\ET\F is directly connected to the CPU of the PC and is not used for external diagnosis.

- The **Pins 36** and **38** are disabled and are '**not used**'. When you start the PC, the operating system does not ask for an USB driver.

### **Pin 42 (Bootstart) and 44 , 46**

- **Pin 42 (Bootstart):** For all PC cards CIFX 90E-2FB\ET\F or CIFX 90E-2FB\MR\ET\F **pin 42** is used for **Bootstart**.

For the PC cards CIFX 90E-2FB\ET\F or CIFX 90E-2FB\MR\ET\F the **Pins 44** and **48** are '**not used**', as listed in the *Table 116* on page 137.

According to the bus specification for Mini PCI Express [bus spec 6] the pins are used to realize the LED status (Pin 42 „WWAN#“, Pin 44 „WLAN#“, Pin 46 „WPAN#“).

# 10 Technical Data

## 10.1 Technical Data PC Cards cifX



**Note:** All technical data are temporarily and can be altered without notice.

### 10.1.1 CIFX 80-RE

CIFX 80-RE	Parameter	Value
Part	Name	CIFX 80-RE
	Part No.	1280.100
	Description	PC Card cifX Compact PCI for Real-Time Ethernet Master or Slave
	Function	Communication interface with Compact PCI and Ethernet interface
Communication Controller	Type	netX 100 processor
Integrated Memory	RAM	8 MB SDRAM
	FLASH	4 MB serial Flash EPROM
	Size of the Dual-Port Memory	64 KByte
System Interface	Bus Type	Compact PCI, according to [bus spec 4], refer to section <i>Overview</i> , page 132.
	Transmission Rate	33 MHz
	Data Access	DPM or DMA (Direct Memory Access)
	Width for the data access to the Dual-Port Memory (DPM)	32-Bit
Ethernet Communication	Supported Real-Time Ethernet communication systems (determined by the loaded firmware)	EtherCAT Master, EtherCAT Slave
		EtherNet/IP Scanner (Master), EtherNet/IP Adapter (Slave),
		Open Modbus/TCP
		POWERLINK Controlled Node/Slave
		PROFINET IO-Controller (Master), PROFINET IO-Device (Slave)
		sercos Master, sercos Slave
	VARAN Client (Slave)	
Ethernet Frame Types	Ethernet II	
Ethernet Interface	Transmission rate	100 MBit/s, 10 MBit/s (depending on loaded firmware)
	Interface Type	100 BASE-TX, 10 BASE-T (depending on loaded firmware), refer to section <i>Ethernet Interface</i> , page 123.
	Galvanic Isolation	isolated
	Isolation Voltage	1000 VDC (tested for 1 minute)
	Half duplex/Full duplex	depending on loaded firmware, supported (at 100 MBit/s)
	Auto-Negotiation	depending on loaded firmware
	Auto-Crossover	depending on loaded firmware
	Connector	2* RJ45 Socket

CIFX 80-RE	Parameter	Value
	Channel 0 and 1	With loaded EtherCAT Master firmware only the RJ45 channel 0 can be used, channel 1 is deactivated. Beginning with the EtherCAT Master firmware version 3 channel 1 can be reactivated if redundancy is activated. For Open Modbus/TCP with V2.3.4.0 and higher both RJ45 channels can be used.
Diagnostic Interface	USB Interface	Mini B USB Plug (5 pin), refer to section <i>Mini-B USB Connector (5 Pin)</i> , page 127.
Display	LED Display	<p><b>SYS</b> System Status LED</p> <p>The meaning of the following LEDs depends on the loaded firmware:</p> <p><b>COM 0</b> LED Communication Status 0 (duo LED)</p> <p><b>COM 1</b> LED Communication Status 1 (duo LED)</p> <p><b>LED yellow</b> at RJ45Ch0 and RJ45Ch1, for Ethernet Link status, Ethernet Activity status and additional status</p> <p><b>LED green</b></p> <p>Refer to chapter <i>LED Descriptions</i>, page 94.</p>
Power supply	Supply Voltage	+3.3 V dc $\pm 5\%$ , refer to section <i>Power Supply and Host Interface</i> , page 46.
	Maximum Current at 3.3 V (typically)	650 mA
	Connector	Via Compact PCI Bus
Environmental Conditions	Operating temperature range*	0 °C ... +70 °C
	*Air flow during measurement	0,5m/s
	Storage temperature range	0 °C ... +70 °C
	Humidity	10 ... 95% relative humidity, no condensation permitted
	Environment	For UL compliant usage: The device must be used in a pollution degree 2 environment.
Device	Dimensions (L x W x H)	162,5 x 100 x 20 mm
	Mounting/Installation	Compact PCI slot (3.3 V), refer to section <i>Slot for the PC Cards cifX Compact PCI, Mini PCI, Mini PCIe, PCI-104</i> , page 43.
	RoHS	Yes
CE Sign	CE Sign	Yes
	Emission	EN 55011:2009 + A1:2010, CISPR 11:2009, Class A (Radio disturbance characteristics - Limits and methods of measurement)
	Immunity	EN 61000-4-2:2009 (Electrostatic discharge test) EN 61000-4-3:2006 + A1:2008 + A2:2010 (Radiated, radio-frequency, electromagnetic field test) EN 61000-4-4:2004 + A1:2010 (Burst Electrical fast transients/burst test) EN 61000-4-5:2006 (Surge test) EN 61000-4-6:2009 (to conducted disturbances, induced by radio- frequency fields) EN 61000-4-8:2010 (power frequency magnetic field test) EN 61000-6-2:2005 + B1:2011 (for industrial environments)
UL Certification	The device is certified according to UL 508	UL-File-Nr. E221530
Configuration	Configuration Software Master and Slave	SYCON.net

CIFX 80-RE	Parameter	Value
	Configuration Software Slave	netX Configuration Tool

Table 117: Technical Data CIFX 80-RE

### 10.1.2 CIFX 80-DP

CIFX 80-DP	Parameter	Value
Part	Name	CIFX 80-DP
	Part No.	1280.410
	Description	PC Card cifX Compact PCI PROFIBUS DP Master or Slave and PROFIBUS MPI Device
	Function	Communication interface with Compact PCI and PROFIBUS interface
Communication Controller	Type	netX 100 processor
Integrated Memory	RAM	8 MB SDRAM
	FLASH	4 MB serial Flash EPROM
	Size of the Dual-Port Memory	64 KByte
System Interface	Bus Type	Compact PCI, according to [bus spec 4], refer to section <i>Overview</i> , page 132.
	Transmission Rate	33 MHz
	Data Access	DPM or DMA (Direct Memory Access)
	Width for the data access to the Dual-Port Memory (DPM)	32-Bit
PROFIBUS Communication	Supported communication standard/ protocol (determined by the loaded firmware)	PROFIBUS DP Master, PROFIBUS DP Slave, PROFIBUS MPI Device
PROFIBUS Interface	Transmission rate	9,6 kBit/s, 19,2 kBit/s, 31,25 kBit/s, 45,45 kBit/s, 93,75 kBit/s, 187,5 kBit/s, 500 kBit/s, 1,5 MBit/s, 3 MBit/s, 6 MBit/s, 12 MBit/s
	Interface Type	RS 485, refer to section <i>PROFIBUS Interface</i> page 125.
	Galvanic Isolation	isolated
	Isolation Voltage	1000 VDC (tested for 1 minute)
	Connector	DSub female Connector, 9 pin
Diagnostic Interface	USB Interface	Mini B USB Plug (5 pin), refer to section <i>Mini-B USB Connector (5 Pin)</i> , page 127.
Display	LED Display	<b>SYS</b> System Status LED <b>COM</b> LED Communication Status (duo LED) The meaning of the LED COM depends on the loaded firmware. Refer to chapter <i>LED Descriptions</i> , page 94.
Power supply	Supply Voltage	+3.3 V dc $\pm 5\%$ , refer to section <i>Power Supply and Host Interface</i> , page 46.
	Maximum Current at 3.3 V (typically)	650 mA
	Connector	Via Compact PCI Bus
Environmental Conditions	Operating temperature range*	-20 °C ... +70 °C (acc. to UL: 0 °C ... +70 °C)
	*Air flow during measurement	0,5m/s
	Storage temperature range	-10 °C ... +70 °C
	Humidity	10 ... 95% relative humidity, no condensation permitted
	Environment	For UL compliant usage: The device must be used in a pollution degree 2 environment.

CIFX 80-DP	Parameter	Value
Device	Dimensions (L x W x H)	162,5 x 100 x 20 mm
	Mounting/Installation	Compact PCI slot (3.3 V), refer to section <i>Slot for the PC Cards cifX Compact PCI, Mini PCI, Mini PCIe, PCI-104</i> , page 43.
	RoHS	Yes
CE Sign	CE Sign	Yes
	Emission	EN 55011:2009 + A1:2010, CISPR 11:2009, Class A (Radio disturbance characteristics - Limits and methods of measurement)
	Immunity	EN 61000-4-2:2009 (Electrostatic discharge test) EN 61000-4-3:2006 + A1:2008 + A2:2010 (Radiated, radio-frequency, electromagnetic field test) EN 61000-4-4:2004 + A1:2010 (Burst Electrical fast transients/burst test) EN 61000-4-5:2006 (Surge test) EN 61000-4-6:2009 (to conducted disturbances, induced by radio- frequency fields) EN 61000-4-8:2010 (power frequency magnetic field test) EN 61000-6-2:2005 + B1:2011 (for industrial environments)
UL Certification	The device is certified according to UL 508	UL-File-Nr. E221530
Configuration	Configuration Software Master and Slave	SYCON.net
	Configuration Software Slave	netX Configuration Tool

Table 118: Technical Data CIFX 80-DP

### 10.1.3 CIFX 80-CO

CIFX 80-CO	Parameter	Value
Part	Name	CIFX 80-CO
	Part No.	1280.500
	Description	PC Card cifX Compact PCI CANopen Master or Slave
	Function	Communication interface with Compact PCI and CANopen interface
Communication Controller	Type	netX 100 processor
Integrated Memory	RAM	8 MB SDRAM
	FLASH	4 MB serial Flash EPROM
	Size of the Dual-Port Memory	64 KByte
System Interface	Bus Type	Compact PCI, according to [bus spec 4], refer to section <i>Overview</i> , page 132.
	Transmission Rate	33 MHz
	Data Access	DPM or DMA (Direct Memory Access)
	Width for the data access to the Dual-Port Memory (DPM)	32-Bit
CANopen Communication	Supported communication standard/ protocol (determined by the loaded firmware)	CANopen Master, CANopen Slave
CANopen Interface	Transmission rate	10 kBit/s, 20 kBit/s, 50 kBit/s, 100 kBit/s, 125 kBit/s, 250 kBit/s, 500 kBit/s, 800 kBit/s, 1 MBit/s
	Interface Type	ISO-11898, refer to section <i>CANopen Interface</i> , page 125.

CIFX 80-CO	Parameter	Value
	Galvanic Isolation	optically isolated
	Isolation Voltage	1000 VDC (tested for 1 minute)
	Connector	DSub male Connector, 9 pin
Diagnostic Interface	USB Interface	Mini B USB Plug (5 pin), refer to section <i>Mini-B USB Connector (5 Pin)</i> , page 127.
Display	LED Display	<b>SYS</b> System Status LED <b>CAN</b> CANopen Status (duo LED)
		The meaning of the LED CAN depends on the loaded firmware. Refer to chapter <i>LED Descriptions</i> , page 94.
Power supply	Supply Voltage	+3.3 V dc $\pm 5\%$ , refer to section <i>Power Supply and Host Interface</i> , page 46.
	Maximum Current at 3.3 V (typically)	650 mA
	Connector	Via Compact PCI Bus
Environmental Conditions	Operating temperature range*	-20 °C ... +70 °C (acc. to UL: 0 °C ... +70 °C)
	*Air flow during measurement	0,5m/s
	Storage temperature range	-10 °C ... +70 °C
	Humidity	10 ... 95% relative humidity, no condensation permitted
	Environment	For UL compliant usage: The device must be used in a pollution degree 2 environment.
Device	Dimensions (L x W x H)	162,5 x 100 x 20 mm
	Mounting/Installation	Compact PCI slot (3.3 V), refer to section <i>Slot for the PC Cards cifX Compact PCI, Mini PCI, Mini PCIe, PCI-104</i> , page 43.
	RoHS	Yes
CE Sign	CE Sign	Yes
	Emission	EN 55011:2009 + A1:2010, CISPR 11:2009, Class A (Radio disturbance characteristics - Limits and methods of measurement)
	Immunity	EN 61000-4-2:2009 (Electrostatic discharge test) EN 61000-4-3:2006 + A1:2008 + A2:2010 (Radiated, radio-frequency, electromagnetic field test) EN 61000-4-4:2004 + A1:2010 (Burst Electrical fast transients/burst test) EN 61000-4-5:2006 (Surge test) EN 61000-4-6:2009 (to conducted disturbances, induced by radio- frequency fields) EN 61000-4-8:2010 (power frequency magnetic field test) EN 61000-6-2:2005 + B1:2011 (for industrial environments)
UL Certification	The device is certified according to UL 508	UL-File-Nr. E221530
Configuration	Configuration Software Master and Slave	SYCON.net
	Configuration Software Slave	netX Configuration Tool

Table 119: Technical Data CIFX 80-CO

### 10.1.4 CIFX 80-DN

CIFX 80-DN	Parameter	Value
Part	Name	CIFX 80-DN
	Part No.	1280.510
	Description	PC Card cifX Compact PCI DeviceNet Master or Slave
	Function	Communication interface with Compact PCI and DeviceNet interface
Communication Controller	Type	netX 100 processor
Integrated Memory	RAM	8 MB SDRAM
	FLASH	4 MB serial Flash EPROM
	Size of the Dual-Port Memory	64 KByte
System Interface	Bus Type	Compact PCI, according to [bus spec 4], refer to section <i>Overview</i> , page 132.
	Transmission Rate	33 MHz
	Data Access	DPM or DMA (Direct Memory Access)
	Width for the data access to the Dual-Port Memory (DPM)	32-Bit
DeviceNet Communication	Supported communication standard/ protocol (determined by the loaded firmware)	DeviceNet Master, DeviceNet Slave
DeviceNet Interface	Transmission rate	125 kBit/s, 250 kBit/s, 500 kBit/s
	Interface Type	ISO-11898 according to DeviceNet specification, refer to section <i>DeviceNet Interface</i> , page 126.
	Galvanic Isolation	optically isolated
	Isolation Voltage	1000 VDC (tested for 1 minute)
	Connector	CombiCon male Connector, 5 pin
Diagnostic Interface	USB Interface	Mini B USB Plug (5 pin), refer to section <i>Mini-B USB Connector (5 Pin)</i> , page 127.
Display	LED Display	<p><b>SYS</b> System Status LED</p> <p><b>MNS</b> Module Network Status (duo LED)</p> <p>The meaning of the LED MNS depends on the loaded firmware. Refer to chapter <i>LED Descriptions</i>, page 94.</p>
Power supply	Supply Voltage	+3.3 V dc $\pm 5\%$ , refer to section <i>Power Supply and Host Interface</i> , page 46.
	Maximum Current at 3.3 V (typically)	650 mA
	Connector	Via Compact PCI Bus
Environmental Conditions	Operating temperature range*	-20 °C ... +70 °C (acc. to UL: 0 °C ... +70 °C)
	*Air flow during measurement	0,5m/s
	Storage temperature range	-10 °C ... +70 °C
	Humidity	10 ... 95% relative humidity, no condensation permitted
	Environment	For UL compliant usage: The device must be used in a pollution degree 2 environment.
Device	Dimensions (L x W x H)	162,5 x 100 x 20 mm
	Mounting/Installation	Compact PCI slot (3.3 V), refer to section <i>Slot for the PC Cards cifX Compact PCI, Mini PCI, Mini PCIe, PCI-104</i> , page 43.
	RoHS	Yes
CE Sign	CE Sign	Yes



CIFX 80-DN	Parameter	Value
	Emission	EN 55011:2009 + A1:2010, CISPR 11:2009, Class A (Radio disturbance characteristics - Limits and methods of measurement)
	Immunity	EN 61000-4-2:2009 (Electrostatic discharge test) EN 61000-4-3:2006 + A1:2008 + A2:2010 (Radiated, radio-frequency, electromagnetic field test) EN 61000-4-4:2004 + A1:2010 (Burst Electrical fast transients/burst test) EN 61000-4-5:2006 (Surge test) EN 61000-4-6:2009 (to conducted disturbances, induced by radio- frequency fields) EN 61000-4-8:2010 (power frequency magnetic field test) EN 61000-6-2:2005 + B1:2011 (for industrial environments)
UL Certification	The device is certified according to UL 508	UL-File-Nr. E221530
Configuration	Configuration Software Master and Slave	SYCON.net
	Configuration Software Slave	netX Configuration Tool

Table 120: Technical Data CIFX 80-DN

### 10.1.5 CIFX 90-RE\F

CIFX 90-RE	Parameter	Value
Part	Name	CIFX 90-RE
	Part No.	1290.100
	Description	PC Card cifX Mini PCI for Real-Time Ethernet Master or Slave composed of: - Basic card CIFX 90 with cable connector Ethernet X4 and - Ethernet assembly interface (AIFX-RE).  <b>Note:</b> The device height and the power input of the PC Card cifX Mini PCI CIFX 90-RE\F do not comply with the standard specifications.
	Function	Communication interface with Mini PCI and Ethernet interface
Communication Controller	Type	netX 100 processor
Integrated Memory	RAM	8 MB SDRAM
	FLASH	4 MB serial Flash EPROM
	Size of the Dual-Port Memory	64 KByte
System Interface	Bus Type	Mini PCI, according to [bus spec 5], refer to section <i>Overview</i> , page 132 and <i>Pin Assignment for Mini PCI Bus, X1</i> , page 133.
	Transmission Rate	33 MHz
	Data Access	DPM or DMA (Direct Memory Access)
	Width for the data access to the Dual-Port Memory (DPM)	32-Bit
Ethernet Communication	Supported Real-Time Ethernet communication systems (determined by the loaded firmware)	EtherCAT Master, EtherCAT Slave
		EtherNet/IP Scanner (Master), EtherNet/IP Adapter (Slave),
		Open Modbus/TCP
		POWERLINK Controlled Node/Slave
		PROFINET IO-Controller (Master), PROFINET IO-Device (Slave)

CIFX 90-RE	Parameter	Value
		sercos Master, sercos Slave
		VARAN Client (Slave)
	Ethernet Frame Types	Ethernet II
Ethernet Interface	Transmission rate	100 MBit/s, 10 MBit/s (depending on loaded firmware)
	Interface Type	100 BASE-TX, 10 BASE-T (depending on loaded firmware), refer to section <i>Ethernet Interface</i> , page 123.
	Half duplex/Full duplex	depending on loaded firmware, supported (at 100 MBit/s)
	Auto-Negotiation	depending on loaded firmware
	Auto-Crossover	depending on loaded firmware
	Ethernet Assembly Interface	AIFX-RE, refer to section <i>AIFX-RE</i> , page 191. <b>Important!</b> Operating the PC card CIFX 90-RE\F requires proper connection of the Ethernet assembly interface (AIFX-RE) to the basic card!
	Connector AIFX-RE	Cable Connector Ethernet X4 (JST SM20B-SRSS-TB(LF)(SN), Pitch 1.0 mm)
	Channel 0 and 1	With loaded EtherCAT Master firmware only the RJ45 channel 0 can be used, channel 1 is deactivated. Beginning with the EtherCAT Master firmware version 3 channel 1 can be reactivated if redundancy is activated. For Open Modbus/TCP with V2.3.4.0 and higher both RJ45 channels can be used.
Display	LED Display	<b>SYS</b> System Status LED
		For LEDs at AIFX-RE, refer to section <i>AIFX-RE</i> , page 191.
Power supply	Supply Voltage	+3.3 V dc $\pm$ 5 %, refer to section <i>Power Supply and Host Interface</i> , page 46.
	Maximum Current at 3.3 V (typically)	650 mA
	Connector	Via Mini PCI PCI Bus
Environmental Conditions	Operating temperature range*	0 °C ... +70 °C
	*Air flow during measurement	0,5m/s
	Storage temperature range	0 °C ... +70 °C
	Humidity	10 ... 95% relative humidity, no condensation permitted
	Environment	For UL compliant usage: The device must be used in a pollution degree 2 environment.
Device	Dimensions (L x W x H)	60 x 45 x 9,5 mm
	Mounting/Installation	Mini PCI Socket (3.3 V), Type III System Connector, refer to section <i>Slot for the PC Cards cifX Compact PCI, Mini PCI, Mini PCIe, PCI-104</i> , page 43.
	RoHS	Yes
CE Sign	CE Sign	Yes
	Emission	EN 55011:2009 + A1:2010, CISPR 11:2009, Class A (Radio disturbance characteristics - Limits and methods of measurement)
	Immunity	EN 61000-4-2:2009 (Electrostatic discharge test) EN 61000-4-3:2006 + A1:2008 + A2:2010 (Radiated, radio-frequency, electromagnetic field test) EN 61000-4-4:2004 + A1:2010 (Burst Electrical fast transients/burst test) EN 61000-4-5:2006 (Surge test) EN 61000-4-6:2009 (to conducted disturbances, induced by radio- frequency fields) EN 61000-4-8:2010 (power frequency magnetic field test)

CIFX 90-RE	Parameter	Value
		EN 61000-6-2:2005 + B1:2011 (for industrial environments)
UL Certification	The device is certified according to UL 508	UL-File-Nr. E221530
Configuration	Configuration Software Master and Slave	SYCON.net
	Configuration Software Slave	netX Configuration Tool

Table 121: Technical Data CIFX 90-RE\F

### 10.1.6 CIFX 90-DP\F

CIFX 90E-DP\F	Parameter	Value
Part	Name	CIFX 90-DP\F
	Part No.	1290.410
	Description	PC Card cifX Mini PCI PROFIBUS DP Master or Slave and PROFIBUS MPI Device composed of: - Basic card CIFX 90 with cable connector Fieldbus X3 and - PROFIBUS assembly interface (AIFX-DP). <b>Note:</b> The device height and the power input of the PC Card cifX Mini PCI CIFX 90-DP\F do not comply with the standard specifications.
	Function	Communication interface with Mini PCI-Socket and PROFIBUS interface
Communication Controller	Type	netX 100 processor
Integrated Memory	RAM	8 MB SDRAM
	FLASH	4 MB serial Flash EPROM
	Size of the Dual-Port Memory	64 KByte
System Interface	Bus Type	Mini PCI, according to [bus spec 5], refer to section <i>Overview</i> , page 132 and <i>Pin Assignment for Mini PCI Bus, X1</i> , page 133.
	Transmission Rate	33 MHz
	Data Access	DPM or DMA (Direct Memory Access)
	Width for the data access to the Dual-Port Memory (DPM)	32-Bit
PROFIBUS Communication	Supported communication standard/ protocol (determined by the loaded firmware)	PROFIBUS DP Master, PROFIBUS DP Slave, PROFIBUS MPI Device
PROFIBUS Interface	Transmission rate	9,6 kBit/s, 19,2 kBit/s, 31,25 kBit/s, 45,45 kBit/s, 93,75 kBit/s, 187,5 kBit/s, 500 kBit/s, 1,5 MBit/s, 3 MBit/s, 6 MBit/s, 12 MBit/s
	Interface Type	RS 485, refer to section <i>PROFIBUS Interface</i> page 125.
	PROFIBUS Assembly Interface	AIFX-DP, refer to section <i>AIFX-DP</i> page 192. <b>Important!</b> Operating the PC card CIFX 90-DP\F requires proper connection of the PROFIBUS assembly interface (AIFX-DP) to the basic card!
	Connector AIFX-DP	Connector Fieldbus X3 (JST 10FMN-SMT-A-TF(LF)(SN), Pitch 1,0 mm)
Display	LED Display	<b>SYS</b> System Status LED
		For LEDs at AIFX-DP, refer to section <i>AIFX-DP</i> page 192.
Power supply	Supply Voltage	+3.3 V dc $\pm 5\%$ , refer to section <i>Power Supply and Host Interface</i> , page 46.
	Maximum Current at 3.3 V (typically)	650 mA

CIFX 90E-DP\F	Parameter	Value
	Connector	Via Mini PCI Bus
Environmental Conditions	Operating temperature range*	-20 °C ... +70 °C (acc. to UL: 0 °C ... +70 °C)
	*Air flow during measurement	0,5m/s
	Storage temperature range	-10 °C ... +70 °C
	Humidity	10 ... 95% relative humidity, no condensation permitted
	Environment	For UL compliant usage: The device must be used in a pollution degree 2 environment.
Device	Dimensions (L x W x H)	60 x 45 x 9,5 mm
	Mounting/Installation	Mini PCI Socket (3.3 V), Type III System Connector, refer to section <i>Slot for the PC Cards cifX Compact PCI, Mini PCI, Mini PCIe, PCI-104</i> , page 43.
	RoHS	Yes
CE Sign	CE Sign	Yes
	Emission	EN 55011:2009 + A1:2010, CISPR 11:2009, Class A (Radio disturbance characteristics - Limits and methods of measurement)
	Immunity	EN 61000-4-2:2009 (Electrostatic discharge test) EN 61000-4-3:2006 + A1:2008 + A2:2010 (Radiated, radio-frequency, electromagnetic field test) EN 61000-4-4:2004 + A1:2010 (Burst Electrical fast transients/burst test) EN 61000-4-5:2006 (Surge test) EN 61000-4-6:2009 (to conducted disturbances, induced by radio- frequency fields) EN 61000-4-8:2010 (power frequency magnetic field test) EN 61000-6-2:2005 + B1:2011 (for industrial environments)
UL Certification	The device is certified according to UL 508	UL-File-Nr. E221530
Configuration	Configuration Software Master and Slave	SYCON.net
	Configuration Software Slave	netX Configuration Tool

Table 122: Technical Data CIFX 90-DP\F

### 10.1.7 CIFX 90-CO\F

CIFX 90-CO\F	Parameter	Value
Part	Name	CIFX 90-CO\F
	Part No.	1290.500
	Description	PC Card cifX Mini PCI CANopen Master or Slave composed of: - Basic card CIFX 90 with cable connector Fieldbus X3 and - CANopen assembly interface (AIFX-CO). <b>Note:</b> The device height and the power input of the PC Card cifX Mini PCI CIFX 90-CO\F do not comply with the standard specifications.
	Function	Communication interface with Mini PCI-Socket and CANopen interface
Communication Controller	Type	netX 100 processor
Integrated Memory	RAM	8 MB SDRAM
	FLASH	4 MB serial Flash EPROM

CIFX 90-CO\F	Parameter	Value
	Size of the Dual-Port Memory	64 KByte
System Interface	Bus Type	Mini PCI, according to [bus spec 5], refer to section <i>Overview</i> , page 132 and <i>Pin Assignment for Mini PCI Bus, X1</i> , page 133.
	Transmission Rate	33 MHz
	Data Access	DPM or DMA (Direct Memory Access)
	Width for the data access to the Dual-Port Memory (DPM)	32-Bit
CANopen Communication	Supported communication standard/ protocol (determined by the loaded firmware)	CANopen Master, CANopen Slave
CANopen Interface	Transmission rate	10 kBit/s, 20 kBit/s, 50 kBit/s, 100 kBit/s, 125 kBit/s, 250 kBit/s, 500 kBit/s, 800 kBit/s, 1 MBit/s
	Interface Type	ISO-11898, refer to section <i>CANopen Interface</i> , page 125.
	CANopen Assembly Interface	AIFX-CO, refer to section <i>AIFX-CO</i> , page 193. <b>Important!</b> Operating the PC card CIFX 90-CO\F requires proper connection of the CANopen assembly interface (AIFX-CO) to the basic card!
	Connector AIFX-CO	Connector Fieldbus X3 (JST 10FMN-SMT-A-TF(LF)(SN), Pitch 1,0 mm)
Display	LED Display	<b>SYS</b> System Status LED
		For LEDs at AIFX-CO, refer to section <i>AIFX-CO</i> , p. 193.
Power supply	Supply Voltage	+3.3 V dc $\pm 5\%$ , refer to section <i>Power Supply and Host Interface</i> , page 46.
	Maximum Current at 3.3 V (typically)	650 mA
	Connector	Via Mini PCI Bus
Environmental Conditions	Operating temperature range*	-20 °C ... +70 °C (acc. to UL: 0 °C ... +70 °C)
	*Air flow during measurement	0,5m/s
	Storage temperature range	-10 °C ... +70 °C
	Humidity	10 ... 95% relative humidity, no condensation permitted
	Environment	For UL compliant usage: The device must be used in a pollution degree 2 environment.
Device	Dimensions (L x W x H)	60 x 45 x 9,5 mm
	Mounting/Installation	Mini PCI Socket (3.3 V), Type III System Connector, refer to section <i>Slot for the PC Cards cifX Compact PCI, Mini PCI, Mini PCIe, PCI-104</i> , page 43.
	RoHS	Yes
CE Sign	CE Sign	Yes
	Emission	EN 55011:2009 + A1:2010, CISPR 11:2009, Class A (Radio disturbance characteristics - Limits and methods of measurement)
	Immunity	EN 61000-4-2:2009 (Electrostatic discharge test) EN 61000-4-3:2006 + A1:2008 + A2:2010 (Radiated, radio-frequency, electromagnetic field test) EN 61000-4-4:2004 + A1:2010 (Burst Electrical fast transients/burst test) EN 61000-4-5:2006 (Surge test) EN 61000-4-6:2009 (to conducted disturbances, induced by radio- frequency fields) EN 61000-4-8:2010 (power frequency magnetic field test) EN 61000-6-2:2005 + B1:2011 (for industrial

CIFX 90-CO\F	Parameter	Value
		environments)
UL Certification	The device is certified according to UL 508	UL-File-Nr. E221530
Configuration	Configuration Software Master and Slave	SYCON.net
	Configuration Software Slave	netX Configuration Tool

Table 123: Technical Data CIFX 90-CO\F

### 10.1.8 CIFX 90-DN\F

CIFX 90-DN\F	Parameter	Value
Part	Name	CIFX 90-DN\F
	Part No.	1290.510
	Description	PC Card cifX Mini PCI DeviceNet Master or Slave composed of: - Basic card CIFX 90 with cable connector Fieldbus X3 and - DeviceNet assembly interface (AIFX-DN). <b>Note:</b> The device height and the power input of the PC Card cifX Mini PCI CIFX 90-DN\F do not comply with the standard specifications.
	Function	Communication interface with Mini PCI-Socket and DeviceNet interface
Communication Controller	Type	netX 100 processor
Integrated Memory	RAM	8 MB SDRAM
	FLASH	4 MB serial Flash EPROM
	Size of the Dual-Port Memory	64 KByte
System Interface	Bus Type	Mini PCI, according to [bus spec 5], refer to section <i>Overview</i> , page 132 and <i>Pin Assignment for Mini PCI Bus, X1</i> , page 133.
	Transmission Rate	33 MHz
	Data Access	DPM or DMA (Direct Memory Access)
	Width for the data access to the Dual-Port Memory (DPM)	32-Bit
DeviceNet Communication	Supported communication standard/ protocol (determined by the loaded firmware)	DeviceNet Master, DeviceNet Slave
DeviceNet Interface	Transmission rate	125 kBit/s, 250 kBit/s, 500 kBit/s
	Interface Type	ISO-11898 according to DeviceNet specification, refer to section <i>DeviceNet Interface</i> , page 126
	DeviceNet Assembly Interface	AIFX-DN, refer to section <i>AIFX-DN</i> , page 194. <b>Important!</b> Operating the PC card CIFX 90-DN\F requires proper connection of the DeviceNet assembly interface (AIFX-DN) to the basic card!
	Connector AIFX-DN	Connector Fieldbus X3 (JST 10FMN-SMT-A-TF(LF)(SN), Pitch 1,0 mm)
Display	LED Display	<b>SYS</b> System Status LED For LED at AIFX-DN, refer to section <i>AIFX-DN</i> , p. 194.
Power supply	Supply Voltage	+3.3 V dc $\pm 5\%$ , refer to section <i>Power Supply and Host Interface</i> , page 46.
	Maximum Current at 3.3 V (typically)	650 mA
	Connector	Via Mini PCI Bus

CIFX 90-DN\F	Parameter	Value
Environmental Conditions	Operating temperature range*	-20 °C ... +70 °C (acc. to UL: 0 °C ... +70 °C)
	*Air flow during measurment	0,5m/s
	Storage temperature range	-10 °C ... +70 °C
	Humidity	10 ... 95% relative humidity, no condensation permitted
	Environment	For UL compliant usage: The device must be used in a pollution degree 2 environment.
Device	Dimensions (L x W x H)	60 x 45 x 9,5 mm
	Mounting/Installation	Mini PCI Socket (3.3 V), Type III System Connector, refer to section <i>Slot for the PC Cards cifX Compact PCI, Mini PCI, Mini PCIe, PCI-104</i> , page 43.
	RoHS	Yes
CE Sign	CE Sign	Yes
	Emission	EN 55011:2009 + A1:2010, CISPR 11:2009, Class A (Radio disturbance characteristics - Limits and methods of measurement)
	Immunity	EN 61000-4-2:2009 (Electrostatic discharge test) EN 61000-4-3:2006 + A1:2008 + A2:2010 (Radiated, radio-frequency, electromagnetic field test) EN 61000-4-4:2004 + A1:2010 (Burst Electrical fast transients/burst test) EN 61000-4-5:2006 (Surge test) EN 61000-4-6:2009 (to conducted disturbances, induced by radio- frequency fields) EN 61000-4-8:2010 (power frequency magnetic field test) EN 61000-6-2:2005 + B1:2011 (for industrial environments)
UL Certification	The device is certified according to UL 508	UL-File-Nr. E221530
Configuration	Configuration Software Master and Slave	SYCON.net
	Configuration Software Slave	netX Configuration Tool

Table 124: Technical Data CIFX 90-DN\F

### 10.1.9 CIFX 90-CC\F

CIFX 90-CC\F	Parameter	Value
Part	Name	CIFX 90-CC\F
	Part No.	1290.740
	Description	PC Card cifX Mini PCI CC-Link Slave composed of: - Basic card CIFX 90 with cable connector Fieldbus X3 and - CC-Link assembly interface (AIFX-CC).  <b>Note:</b> The device height and the power input of the PC Card cifX Mini PCI CIFX 90-CC\F do not comply with the standard specifications.
	Function	Communication interface with Mini PCI-Socket and CC-Link interface
Communication Controller	Type	netX 100 processor
Integrated Memory	RAM	8 MB SDRAM
	FLASH	4 MB serial Flash EPROM
	Size of the Dual-Port Memory	64 KByte

CIFX 90-CC\F	Parameter	Value
System Interface	Bus Type	Mini PCI, according to [bus spec 5], refer to section <i>Overview</i> , page 132 and <i>Pin Assignment for Mini PCI Bus, X1</i> , page 133.
	Transmission Rate	33 MHz
	Data Access	DPM or DMA (Direct Memory Access)
	Width for the data access to the Dual-Port Memory (DPM)	32-Bit
CC-Link Communication	Supported communication standard/ protocol (determined by the loaded firmware)	CC-Link Slave
CC-Link Interface	Transmission rate	156 kBit/s, 625 kBit/s, 2500 kBit/s, 5 MBit/s, 10 MBit/s
	Interface Type	RS-485, refer to section <i>CC-Link Interface</i> , page 126.
	CC-Link Assembly Interface	AIFX-CC, refer to section <i>AIFX-CC</i> , page 195. <b>Important!</b> Operating the PC card CIFX 90-CC\F requires proper connection of the CC-Link assembly interface (AIFX-CC) to the basic card!
	Connector AIFX-CC	Connector Fieldbus X3 (JST 10FMN-SMT-A-TF(LF)(SN), Pitch 1,0 mm)
Display	LED Display	<b>SYS</b> System Status LED
		For LEDs at AIFX-CC, refer to section <i>AIFX-CC</i> , p. 195.
Power supply	Supply Voltage	+3.3 V dc $\pm 5\%$ , refer to section <i>Power Supply and Host Interface</i> , page 46.
	Maximum Current at 3.3 V (typically)	650 mA
	Connector	Via Mini PCI Bus
Environmental Conditions	Operating temperature range*	0 °C ... +60 °C
	*Air flow during measurement	0,5m/s
	Storage temperature range	-10 °C ... +70 °C
	Humidity	10 ... 95% relative humidity, no condensation permitted
Device	Dimensions (L x W x H)	60 x 45 x 9,5 mm
	Mounting/Installation	Mini PCI Socket (3.3 V), Type III System Connector, refer to section <i>Slot for the PC Cards cifX Compact PCI, Mini PCI, Mini PCIe, PCI-104</i> , page 43.
	RoHS	Yes
CE Sign	CE Sign	Yes
	Emission	EN 55011:2009 + A1:2010, CISPR 11:2009, Class A (Radio disturbance characteristics - Limits and methods of measurement)
	Immunity	EN 61000-4-2:2009 (Electrostatic discharge test) EN 61000-4-3:2006 + A1:2008 + A2:2010 (Radiated, radio-frequency, electromagnetic field test) EN 61000-4-4:2004 + A1:2010 (Burst Electrical fast transients/burst test) EN 61000-4-5:2006 (Surge test) EN 61000-4-6:2009 (to conducted disturbances, induced by radio- frequency fields) EN 61000-4-8:2010 (power frequency magnetic field test) EN 61000-6-2:2005 + B1:2011 (for industrial environments)
Configuration	Configuration Software	SYCON.net or netX Configuration Tool

Table 125: Technical Data CIFX 90-CC\F



### 10.1.10 CIFX 90E-RE\F, CIFX 90E-RE\ET\F, CIFX 90E-RE\MR\F, CIFX 90E-RE\MR\ET\F

CIFX 90E-RE\F, CIFX 90E-RE\ET\F CIFX 90E-RE\MR\F CIFX 90E-RE\MR\ET\F	Parameter	Value	
Part	Name	CIFX 90E-RE\F	CIFX 90E-RE\ET\F
	Part No.	1291.100	1291.104
	Name	CIFX 90E-RE\MR\F	CIFX 90E-RE\MR\ET\F
	Part No.	1291.102	1291.106
	Description	PC Card cifX Mini PCI Express for Real-Time Ethernet Master or Slave (and variants with additional MRAM ,MR' and enlarged temperature range ,ET') composed of: - Basic card CIFX 90E, CIFX 90\ET, CIFX 90\EMR or CIFX 90\MR\ET with cable connector Ethernet X4 and - Ethernet assembly interface (AIFX-RE).  <b>Note:</b> The device height and the power input of the PC Card cifX Mini PCI Express CIFX 90E-RE\F, CIFX 90E-RE\ET\F, CIFX 90E-RE\MR\F and CIFX 90E-RE\MR\ET\F do not comply with the standard specifications.	
Function	Communication Interface with Mini PCI Express and Ethernet interface		
Communication Controller	Type	netX 100 processor	
Integrated Memory	RAM	8 MB SDRAM	
	FLASH	4 MB serial Flash EPROM	
	Size of the Dual-Port Memory	64 KByte	
	MRAM (only CIFX 90E-RE\MR\F and CIFX 90E-RE\MR\ET\F)	128Kbyte (= 64K Words); <b>Note:</b> Using the cifX Device Driver (from Version 1.1.1.0) access to this memory is possible and it can be used as a remanent memory.	
System Interface	Bus Type	Mini PCI Express, One Lane Port, according to [bus spec 2], refer to section <i>Overview</i> , page 132 and <i>Pin Assignment for Mini PCI Express Bus / SYNC Connector (Bootstart)</i> , X1/X2, page 135.	
	Transmission Rate	33 MHz	
	Data Access	DPM or DMA* (Direct Memory Access); *CIFX 90E-RE\F from Hardware Revision A, CIFX 90E-RE\MR\F from Hardware Revision B, CIFX 90E-RE\ET\F and CIFX 90E-RE\MR\ET\F from Hardware Revision 1	
	Width for the data access to the Dual-Port Memory (DPM)	32-Bit	
Ethernet Communication	Supported Real-Time Ethernet communication systems (determined by the loaded firmware)	EtherCAT Master, EtherCAT Slave	
		EtherNet/IP Scanner (Master), EtherNet/IP Adapter (Slave),	
		Open Modbus/TCP	
		POWERLINK Controlled Node/Slave	
		PROFINET IO-Controller (Master), PROFINET IO-Device (Slave)	
		sercos Master, sercos Slave	
	VARAN Client (Slave)		
Ethernet Frame Types	Ethernet II		
Ethernet Interface	Transmission Rate	100 MBit/s, 10 MBit/s (depending on loaded firmware)	
	Interface Type	100 BASE-TX, 10 BASE-T (depending on loaded firmware),	

CIFX 90E-RE\F, CIFX 90E-RE\ET\F, CIFX 90E-RE\MR\F, CIFX 90E-RE\MR\ET\F	Parameter	Value	
		refer to section <i>Ethernet Interface</i> , page 123.	
	Half duplex/Full duplex	depending on loaded firmware, supported (at 100 MBit/s)	
	Auto-Negotiation	depending on loaded firmware	
	Auto-Crossover	depending on loaded firmware	
	Ethernet Assembly Interface	AIFX-RE, refer to section <i>AIFX-RE</i> , page 191. <b>Important!</b> Operating the PC card CIFX 90E-RE\F (all variants 'MR' or 'ET') requires proper connection of the Ethernet assembly interface (AIFX-RE) to the basic card!	
	Connector AIFX-RE	Cable Connector Ethernet X4 (JST BM20B-SRDS-G-TFC, Pitch 1,0 mm)	
	Channel 0 and 1	With loaded EtherCAT Master firmware only the RJ45 channel 0 can be used, channel 1 is deactivated. Beginning with the EtherCAT Master firmware version 3 channel 1 can be reactivated if redundancy is activated. For Open Modbus/TCP with V2.3.4.0 and higher both RJ45 channels can be used.	
Display	LED Display	<b>SYS</b> System Status LED	
		For LEDs at AIFX-RE, refer to section <i>AIFX-RE</i> , page 191.	
Power supply	Supply Voltage	+3.3 V dc $\pm 5\%$ , refer to section <i>Power Supply and Host Interface</i> , page 46.	
	Maximum Current at at 3.3 V (typically)	800 mA	
	Connector	Via Mini PCI Express Bus	
Environmental Conditions		CIFX 90E-RE\F, CIFX 90E-RE\MR\F	CIFX 90E-RE\ET\F, CIFX 90E-RE\MR\ET\F
	Operating temperature range*	0 °C ... +55 °C	0 °C ... +70 °C
	*Air flow during measurement	0,5m/s	
	Storage temperature range	0 °C ... +70 °C	
	Humidity	10 ... 95% relative humidity, no condensation permitted	
	Environment	For UL compliant usage: The device must be used in a pollution degree 2 environment.	
Device	Dimensions (L x W x H)	CIFX 90E-RE\F <sup>1,2</sup> , CIFX 90E-RE\MR\F <sup>2</sup>	CIFX 90E-RE\ET\F, CIFX 90E-RE\MR\ET\F
		51 x 30,2 +/- 0,1 x 11 mm	51 x 30,2 +/- 0,1 x 12,5 mm
		<sup>2</sup> Beginning with hardware revision A: 51 x 30,2 mm + 0,1 / - 0,1 mm x 11 mm; [W = 30,1mm ... 30,3 mm: The printed circuit board (PCB) has become wider on the right side by 0.1 mm ... 0.3 mm, thus deviating from the norm]. <sup>1</sup> For hardware revision 9: 51 x 30,2 x 11 mm; [W = 30,2 mm: The printed circuit board (PCB) has become wider on the right side by 0.2 mm, thus deviating from the norm]. For further details on the element heights refer to section <i>Notes on the Card Height - PC Card cifX Mini PCI and Mini PCIe</i> on page 44.	
	Mounting/Installation	PCI Express Mini System Connector (3.3 V), X1/X2 <sup>9</sup> = One Lane, refer to section <i>Slot for the PC Cards cifX Compact PCI, Mini PCI, Mini PCIe, PCI-104</i> , page 43.	
	RoHS	Yes	
CE Sign	CE Sign	Yes	

<sup>9</sup> X1, X2 corresponds to the Hilscher convention for „interface“ on the top or the bottom side of the PC Card cifX.

CIFX 90E-RE\F, CIFX 90E-RE\ET\F, CIFX 90E-RE\MR\F, CIFX 90E-RE\MR\ET\F	Parameter	Value
	Emission	EN 55011:2009 + A1:2010, CISPR 11:2009, Class A (Radio disturbance characteristics - Limits and methods of measurement)
	Immunity	EN 61000-4-2:2009 (Electrostatic discharge test) EN 61000-4-3:2006 + A1:2008 + A2:2010 (Radiated, radio-frequency, electromagnetic field test) EN 61000-4-4:2004 + A1:2010 (Burst Electrical fast transients/burst test) EN 61000-4-5:2006 (Surge test) EN 61000-4-6:2009 (to conducted disturbances, induced by radio- frequency fields) EN 61000-4-8:2010 (power frequency magnetic field test) EN 61000-6-2:2005 + B1:2011 (for industrial environments)
UL Certification	The device CIFX 90E-RE\F is certified according to UL 508	UL-File-Nr. E221530
Configuration	Configuration Software Master and Slave	SYCON.net
	Configuration Software Slave	netX Configuration Tool

Table 126: Technical Data CIFX 90E-RE\F, CIFX 90E-RE\ET\F, CIFX 90E-RE\MR\F, CIFX 90E-RE\MR\ET\F

### 10.1.11 CIFX 90E-DP\F, CIFX 90E-DP\ET\F, CIFX 90E-DP\MR\F, CIFX 90E-DP\MR\ET\F

CIFX 90E-DP\F, CIFX 90E-DP\ET\F, CIFX 90E-DP\MR\F, CIFX 90E-DP\MR\ET\F	Parameter	Value
Part	Name	CIFX 90E-DP\F      CIFX 90E-DP\ET\F
	Part No.	1291.410      1291.414
	Name	CIFX 90E-DP\MR\F      CIFX 90E-DP\MR\ET\F
	Part No.	1291.112      1291.116
	Description	PC Card cifX Mini PCI Express PROFIBUS DP Master or Slave and PROFIBUS MPI Device (and variants with additional MRAM ,MR' and enlarged temperature range ,ET') composed of: - Basic card CIFX 90E, CIFX 90E\ET, CIFX 90E\MR or CIFX 90E\MR\ET with cable connector Fieldbus X3 and - PROFIBUS assembly interface (AIFX-DP). <b>Note:</b> The device height and the power input of the PC Card cifX Mini PCI Express CIFX 90E-DP\F, CIFX 90E-DP\ET\F, CIFX 90E-DP\MR\F and CIFX 90E-DP\MR\ET\F do not comply with the standard specifications.
Function	Communication Interface with Mini PCI Express and PROFIBUS interface	
Communication Controller	Type	netX 100 processor
Integrated Memory	RAM	8 MB SDRAM
	FLASH	4 MB serial Flash EPROM
	Size of the Dual-Port Memory	64 KByte
	MRAM (only CIFX 90E-DP\MR\F and CIFX 90E-DP\MR\ET\F)	128Kbyte (= 64K Words); <b>Note:</b> Using the cifX Device Driver (from Version 1.1.1.0) access to this memory is possible and it can be used as a

CIFX 90E-DP\F, CIFX 90E-DP\ET\F, CIFX 90E-DP\MR\F, CIFX 90E-DP\MR\ET\F	Parameter	Value	
		remanent memory.	
System Interface	Bus Type	Mini PCI Express One Lane Port, according to [bus spec 2] and [bus spec 6], refer to section <i>Overview</i> , page 132 and <i>Pin Assignment for Mini PCI Express Bus / SYNC Connector (Bootstart)</i> , X1/X2, page 135.	
	Transmission Rate	33 MHz	
	Data Access	DPM or DMA* (Direct Memory Access); *CIFX 90E-DP\F from Hardware Revision A, CIFX 90E-DP\MR\F from Hardware Revision B, CIFX 90E-DP\ET\F and CIFX 90E-DP\MR\ET\F from Hardware Revision 1	
	Width for the data access to the Dual-Port Memory (DPM)	32-Bit	
PROFIBUS Communication	Supported communication standard/ protocol (determined by the loaded firmware)	PROFIBUS DP Master, PROFIBUS DP Slave, PROFIBUS MPI Device	
PROFIBUS interface	Transmission Rate	9,6 kBit/s, 19,2 kBit/s, 31,25 kBit/s, 45,45 kBit/s, 93,75 kBit/s, 187,5 kBit/s, 500 kBit/s, 1,5 MBit/s, 3 MBit/s, 6 MBit/s, 12 MBit/s	
	Interface Type	RS 485, refer to section <i>PROFIBUS Interface</i> page 125.	
	PROFIBUS Assembly Interface	AIFX-DP, refer to section <i>AIFX-DP</i> page 192. <b>Important!</b> Operating the PC card CIFX 90E-DP\F (all variants 'MR' or 'ET') requires proper connection of the PROFIBUS assembly interface (AIFX-DP) to the basic card!	
	Connector AIFX-DP	Cable Connector Fieldbus X3 (JST 10FMN-BMT-A-TF(LF)(SN), Pitch 1,0 mm)	
Display	LED Display	<b>SYS</b> System Status LED	
		For LEDs at AIFX-DP, refer to section <i>AIFX-DP</i> page 192.	
Power supply	Supply Voltage	+3.3 V dc $\pm 5\%$ , refer to section <i>Power Supply and Host Interface</i> , page 46.	
	Maximum Current at at 3.3 V (typically)	600 mA	
	Connector	Via Mini PCI Express Bus	
Environmental Conditions	Operating temperature range*	CIFX 90E-DP\F, CIFX 90E-DP\MR\F	CIFX 90E-DP\ET\F, CIFX 90E-DP\MR\ET\F
		0 °C ... +55 °C	-20 °C ... +70 °C
	Storage temperature range	0 °C ... +70 °C	
	*Air flow during measurment	0,5m/s	
	Humidity	10 ... 95% relative humidity, no condensation permitted	
	Environment	For UL compliant usage: The device must be used in a pollution degree 2 environment.	
Device	Dimensions (L x W x H)	CIFX 90E-DP\F <sup>1,2</sup> , CIFX 90E-DP\MR\F <sup>2</sup>	CIFX 90E-DP\ET\F, CIFX 90E-DP\MR\ET\F
		51 x 30,2 +/- 0,1 x 11 mm	51 x 30,2 +/- 0,1 x 12,5 mm
	<sup>2</sup> Beginning with hardware revision A: 51 x 30,2 mm + 0,1 / - 0,1 mm x 11 mm; [W = 30,1mm ... 30,3 mm: The printed circuit board (PCB) has become wider on the right side by 0.1 mm ... 0.3 mm, thus deviating from the norm]. <sup>1</sup> For hardware revision 9: 51 x 30,2 x 11 mm; [W = 30,2 mm: The printed circuit board (PCB) has become wider on the right side by 0.2 mm, thus deviating from the norm]. For further details on the element hights refer to section <i>Notes on the Card Height - PC Card cifX Mini PCI and</i>		

CIFX 90E-DP\F, CIFX 90E-DP\ET\F, CIFX 90E-DP\MR\F, CIFX 90E-DP\MR\ET\F	Parameter	Value
		Mini PCIe on page 44.
	Mounting/Installation	PCI Express Mini System Connector (3.3 V), X1/X2 <sup>10</sup> = One Lane, refer to section Slot for the PC Cards cifX Compact PCI, Mini PCI, Mini PCIe, PCI-104, page 43.
	RoHS	Yes
CE Sign	CE Sign	Yes
	Emission	EN 55011:2009 + A1:2010, CISPR 11:2009, Class A (Radio disturbance characteristics - Limits and methods of measurement)
	Immunity	EN 61000-4-2:2009 (Electrostatic discharge test) EN 61000-4-3:2006 + A1:2008 + A2:2010 (Radiated, radio-frequency, electromagnetic field test) EN 61000-4-4:2004 + A1:2010 (Burst Electrical fast transients/burst test) EN 61000-4-5:2006 (Surge test) EN 61000-4-6:2009 (to conducted disturbances, induced by radio- frequency fields) EN 61000-4-8:2010 (power frequency magnetic field test) EN 61000-6-2:2005 + B1:2011 (for industrial environments)
UL Certification	The device CIFX 90E-DP\F is certified according to UL 508	UL-File-Nr. E221530
Configuration	Configuration Software Master and Slave	SYCON.net
	Configuration Software Slave	netX Configuration Tool

Table 127: Technical Data CIFX 90E-DP\F, CIFX 90E-DP\ET\F, CIFX 90E-DP\MR\F, CIFX 90E-DP\MR\ET\F

### 10.1.12 CIFX 90E-CO\F, CIFX 90E-CO\ET\F, CIFX 90E-CO\MR\F, CIFX 90E-CO\MR\ET\F

CIFX 90E-CO\F, CIFX 90E-CO\ET\F, CIFX 90E-CO\MR\F, CIFX 90E-CO\MR\ET\F	Parameter	Value	
Part	Name	CIFX 90E-CO\F	CIFX 90E-CO\ET\F
	Part No.	1291.500	1291.504
	Name	CIFX 90E-CO\MR\F	CIFX 90E-CO\MR\ET\F
	Part No.	1291.502	1291.506
	Description	PC Card cifX Mini PCI Express CANopen Master or Slave (and variants with additional MRAM ,MR' and enlarged temperature range ,ET') composed of: - Basic card CIFX 90E, CIFX 90E\ET, CIFX 90E\MR or CIFX 90E\MR\ET with cable connector Fieldbus X3 and - CANopen assembly interface (AIFX-CO). <b>Note:</b> The device height and the power input of the PC Card cifX Mini PCI Express CIFX 90E-CO\F, CIFX 90E-CO\ET\F, CIFX 90E-CO\MR\F and CIFX 90E-CO\MR\ET\F do not comply with the standard specifications.	
	Function	Communication Interface with Mini PCI Express and CANopen interface	

<sup>10</sup> X1, X2 corresponds to the Hilscher convention for „interface“ on the top or the bottom side of the PC Card cifX.

CIFX 90E-CO\F, CIFX 90E-CO\ET\F, CIFX 90E-CO\MR\F, CIFX 90E-CO\MR\ET\F	Parameter	Value		
Communication Controller	Type	netX 100 processor		
Integrated Memory	RAM	8 MB SDRAM		
	FLASH	4 MB serial Flash EPROM		
	Size of the Dual-Port Memory	64 KByte		
	MRAM (only CIFX 90E-CO\MR\F and CIFX 90E-CO\MR\ET\F)	128Kbyte (= 64K Words); <b>Note:</b> Using the cifX Device Driver (from Version 1.1.1.0) access to this memory is possible and it can be used as a remanent memory.		
System Interface	Bus Type	Mini PCI Express One Lane Port, according to [bus spec 2] and [bus spec 6], refer to section <i>Overview</i> , page 132 and <i>Pin Assignment for Mini PCI Express Bus / SYNC Connector (Bootstart), X1/X2</i> , page 135.		
	Transmission Rate	33 MHz		
	Data Access	DPM or DMA* (Direct Memory Access); *CIFX 90E-CO\F from Hardware Revision A, CIFX 90E-CO\MR\F from Hardware Revision B, CIFX 90E-CO\ET\F and CIFX 90E-CO\MR\ET\F from Hardware Revision 1		
	Width for the data access to the Dual-Port Memory (DPM)	32-Bit		
CANopen Communication	Supported communication standard/ protocol (determined by the loaded firmware)	CANopen Master, CANopen Slave		
CANopen interface	Transmission Rate	10 kBit/s, 20 kBit/s, 50 kBit/s, 100 kBit/s, 125 kBit/s, 250 kBit/s, 500 kBit/s, 800 kBit/s, 1 MBit/s		
	Interface Type	ISO-11898, refer to section <i>CANopen Interface</i> , page 125.		
	CANopen Assembly Interface	AIFX-CO, refer to section <i>AIFX-CO</i> , page 193. <b>Important!</b> Operating the PC card CIFX 90E-CO\F (all variants 'MR' or 'ET') requires proper connection of the CANopen assembly interface (AIFX-CO) to the basic card!		
	Connector AIFX-CO	Cable Connector Fieldbus X3 (JST 10FMN-BMT-A-TF(LF)(SN), Pitch 1,0 mm)		
Display	LED Display	<b>SYS</b> System Status LED		
		For LEDs at AIFX-CO, refer to section <i>AIFX-CO</i> , p. 193.		
Power supply	Supply Voltage	+3.3 V dc $\pm 5\%$ , refer to section <i>Power Supply and Host Interface</i> , page 46.		
	Maximum Current at at 3.3 V (typically)	600 mA		
	Connector	Via Mini PCI Express Bus		
Environmental Conditions	Operating temperature range*	CIFX 90E-CO\F, CIFX 90E-CO\MR\F	CIFX 90E-CO\ET\F, CIFX 90E-CO\MR\ET\F	
		0 °C ... +55 °C		-20 °C ... +70 °C
	Storage temperature range	0 °C ... +70 °C		-10 °C ... +70 °C
	*Air flow during measurment	0,5m/s		
	Humidity	10 ... 95% relative humidity, no condensation permitted		
	Environment	For UL compliant usage: The device must be used in a pollution degree 2 environment.		
Device	Dimensions (L x W x H)	CIFX 90E-CO\F <sup>1,2</sup> , CIFX 90E-CO\MR\F <sup>2</sup>	CIFX 90E-CO\ET\F, CIFX 90E-CO\MR\ET\F	
		51 x 30,2 +/- 0,1 x 11 mm	51 x 30,2 +/- 0,1 x 12,5 mm	

CIFX 90E-CO\F, CIFX 90E-CO\ET\F, CIFX 90E-CO\MR\F, CIFX 90E-CO\MR\ET\F	Parameter	Value
		<p><sup>2</sup>Beginning with hardware revision A: 51 x 30,2 mm + 0,1 / - 0,1 mm x 11 mm; [W = 30,1mm ... 30,3 mm: The printed circuit board (PCB) has become wider on the right side by 0.1 mm ... 0.3 mm, thus deviating from the norm].</p> <p><sup>1</sup>For hardware revision 9: 51 x 30,2 x 11 mm; [W = 30,2 mm: The printed circuit board (PCB) has become wider on the right side by 0.2 mm, thus deviating from the norm].</p> <p>For further details on the element heights refer to section <i>Notes on the Card Height - PC Card cifX Mini PCI and Mini PCIe</i> on page 44.</p>
	Mounting/Installation	PCI Express Mini System Connector (3.3 V), X1/X2 <sup>11</sup> = One Lane, refer to section <i>Slot for the PC Cards cifX Compact PCI, Mini PCI, Mini PCIe, PCI-104</i> , page 43.
	RoHS	Yes
CE Sign	CE Sign	Yes
	Emission	EN 55011:2009 + A1:2010, CISPR 11:2009, Class A (Radio disturbance characteristics - Limits and methods of measurement)
	Immunity	EN 61000-4-2:2009 (Electrostatic discharge test) EN 61000-4-3:2006 + A1:2008 + A2:2010 (Radiated, radio-frequency, electromagnetic field test) EN 61000-4-4:2004 + A1:2010 (Burst Electrical fast transients/burst test) EN 61000-4-5:2006 (Surge test) EN 61000-4-6:2009 (to conducted disturbances, induced by radio- frequency fields) EN 61000-4-8:2010 (power frequency magnetic field test) EN 61000-6-2:2005 + B1:2011 (for industrial environments)
UL Certification	The device CIFX 90E-CO\F is certified according to UL 508	UL-File-Nr. E221530
Configuration	Configuration Software Master and Slave	SYCON.net
	Configuration Software Slave	netX Configuration Tool

Table 128: Technical Data CIFX 90E-CO\F, CIFX 90E-CO\ET\F, CIFX 90E-CO\MR\F, CIFX 90E-CO\MR\ET\F

### 10.1.13 CIFX 90E-DN\F, CIFX 90E-DN\ET\F, CIFX 90E-DN\MR\F, CIFX 90E-DN\MR\ET\F

CIFX 90E-DN\F, CIFX 90E-DN\ET\F, CIFX 90E-DN\MR\F, CIFX 90E-DN\MR\ET\F	Parameter	Value
Part	Name	CIFX 90E-DN\F
	Part No.	1291.510
	Name	CIFX 90E-DN\ET\F
	Part No.	1291.514
Part	Name	CIFX 90E-DN\MR\F
	Part No.	1291.512
	Name	CIFX 90E-DN\MR\ET\F
	Part No.	1291.516

<sup>11</sup> X1, X2 corresponds to the Hilscher convention for „interface“ on the top or the bottom side of the PC Card cifX.

CIFX 90E-DNF, CIFX 90E-DN\ET\F, CIFX 90E-DN\MR\F, CIFX 90E-DN\MR\ET\F	Parameter	Value	
	Description	PC Card cifX Mini PCI Express DeviceNet Master or Slave (and variants with additional MRAM ,MR' and enlarged temperature range ,ET') composed of: - Basic card CIFX 90E, CIFX 90E\ET, CIFX 90E\MR or CIFX 90E\MR\ET with cable connector Fieldbus X3 and - DeviceNet assembly interface (AIFX-DN).  <b>Note:</b> The device height and the power input of the PC Card cifX Mini PCI Express CIFX 90E-DNF, CIFX 90E-DN\ET\F, CIFX 90E-DN\MR\F and CIFX 90E-DN\MR\ET\F do not comply with the standard specifications.	
	Function	Communication Interface with Mini PCI Express and DeviceNet interface	
Communication Controller	Type	netX 100 processor	
Integrated Memory	RAM	8 MB SDRAM	
	FLASH	4 MB serial Flash EPROM	
	Size of the Dual-Port Memory	64 KByte	
	MRAM (only CIFX 90E-DN\MR\F and CIFX 90E-DN\MR\ET\F)	128Kbyte (= 64K Words); <b>Note:</b> Using the cifX Device Driver (from Version 1.1.1.0) access to this memory is possible and it can be used as a remanent memory.	
System Interface	Bus Type	Mini PCI Express One Lane Port, according to [bus spec 2] and [bus spec 6], refer to section <i>Overview</i> , page 132 and <i>Pin Assignment for Mini PCI Express Bus / SYNC Connector (Bootstart), X1/X2</i> , page 135.	
	Transmission Rate	33 MHz	
	Data Access	DPM or DMA* (Direct Memory Access); *CIFX 90E-DNF from Hardware Revision A, CIFX 90E-DN\MR\F from Hardware Revision B, CIFX 90E-DN\ET\F and CIFX 90E-DN\MR\ET\F from Hardware Revision 1	
	Width for the data access to the Dual-Port Memory (DPM)	32-Bit	
DeviceNet Communication	Supported communication standard/ protocol (determined by the loaded firmware)	DeviceNet Master, DeviceNet Slave	
DeviceNet interface	Transmission Rate	125 kBit/s, 250 kBit/s, 500 kBit/s	
	Interface Type	ISO-11898 according to DeviceNet specification, refer to section <i>DeviceNet Interface</i> , page 126.	
	DeviceNet Assembly Interface	AIFX-DN, refer to section <i>AIFX-DN</i> , page 194.  <b>Important!</b> Operating the PC card CIFX 90E-DNF (all variants 'MR' or 'ET') requires proper connection of the DeviceNet assembly interface (AIFX-DN) to the basic card!	
	Connector AIFX-DN	Cable Connector Fieldbus X3 (JST 10FMN-BMT-A-TF(LF)(SN), Pitch 1,0 mm)	
Display	LED Display	<b>SYS</b> System Status LED	
		For LED at AIFX-DN, refer to section <i>AIFX-DN</i> , p. 194.	
Power supply	Supply Voltage	+3.3 V dc $\pm 5\%$ , refer to section <i>Power Supply and Host Interface</i> , page 46.	
	Maximum Current at at 3.3 V (typically)	600 mA	
	Connector	Via Mini PCI Express Bus	
Environmental Conditions	Operating temperature range*	CIFX 90E-DNF, CIFX 90E-DN\MR\F	CIFX 90E-DN\ET\F, CIFX 90E-DN\MR\ET\F
		0 °C ... +55 °C	-20 °C ... +70 °C



CIFX 90E-DNF, CIFX 90E-DN\ET\F, CIFX 90E-DN\MR\F, CIFX 90E-DN\MR\ET\F	Parameter	Value	
	Storage temperature range	0 °C ... +70 °C	-10 °C ... +70 °C
	*Air flow during measurement	0,5m/s	
	Humidity	10 ... 95% relative humidity, no condensation permitted	
	Environment	For UL compliant usage: The device must be used in a pollution degree 2 environment.	
Device	Dimensions (L x W x H)	CIFX 90E-DNF <sup>1,2</sup> , CIFX 90E-DN\MR\F <sup>2</sup>	CIFX 90E-DN\ET\F, CIFX 90E-DN\MR\ET\F
		51 x 30,2 +/- 0,1 x 11 mm	51 x 30,2 +/- 0,1 x 12,5 mm
	<sup>2</sup> Beginning with hardware revision A: 51 x 30,2 mm + 0,1 / - 0,1 mm x 11 mm; [W = 30,1mm ... 30,3 mm: The printed circuit board (PCB) has become wider on the right side by 0.1 mm ... 0.3 mm, thus deviating from the norm]. <sup>1</sup> For hardware revision 9: 51 x 30,2 x 11 mm; [W = 30,2 mm: The printed circuit board (PCB) has become wider on the right side by 0.2 mm, thus deviating from the norm]. For further details on the element heights refer to section <i>Notes on the Card Height - PC Card cifX Mini PCI and Mini PCIe</i> on page 44.		
	Mounting/Installation	PCI Express Mini System Connector (3.3 V), X1/X2 <sup>12</sup> = One Lane, refer to section <i>Slot for the PC Cards cifX Compact PCI, Mini PCI, Mini PCIe, PCI-104</i> , page 43.	
	RoHS	Yes	
CE Sign	CE Sign	Yes	
	Emission	EN 55011:2009 + A1:2010, CISPR 11:2009, Class A (Radio disturbance characteristics - Limits and methods of measurement)	
	Immunity	EN 61000-4-2:2009 (Electrostatic discharge test) EN 61000-4-3:2006 + A1:2008 + A2:2010 (Radiated, radio-frequency, electromagnetic field test) EN 61000-4-4:2004 + A1:2010 (Burst Electrical fast transients/burst test) EN 61000-4-5:2006 (Surge test) EN 61000-4-6:2009 (to conducted disturbances, induced by radio- frequency fields) EN 61000-4-8:2010 (power frequency magnetic field test) EN 61000-6-2:2005 + B1:2011 (for industrial environments)	
UL Certification	The device CIFX 90E-DNF is certified according to UL 508	UL-File-Nr. E221530	
Configuration	Configuration Software Master and Slave	SYCON.net	
	Configuration Software Slave	netX Configuration Tool	

Table 129: Technical Data CIFX 90E-DNF, CIFX 90E-DN\ET\F, CIFX 90E-DN\MR\F, CIFX 90E-DN\MR\ET\F

<sup>12</sup> X1, X2 corresponds to the Hilscher convention for „interface“ on the top or the bottom side of the PC Card cifX.

### 10.1.14 CIFX 90E-CC\ET\F, CIFX 90E-CC\MR\ET\F

CIFX 90E-CC\ET\F, CIFX 90E-CC\MR\ET\F	Parameter	Value	
Part	Name	CIFX 90E-CC\ET\F	CIFX 90E-CC\MR\ET\F
	Part No.	1291.744	1291.746
	Description	PC Card cifX Mini PCI Express CC-Link Slave (as variants with additional MRAM ,MR' and enlarged temperature range ,ET') composed of: - Basic card CIFX 90E\ET or CIFX 90E\MR\ET with cable connector Fieldbus X3 and - CC-Link assembly interface (AIFX-CC). <b>Note:</b> The device height and the power input of the PC Card cifX Mini PCI Express CIFX 90E-CC\ET\F and CIFX 90E-CC\MR\ET\F do not comply with the standard specifications.	
	Function	Communication Interface with Mini PCI Express and CC-Link interface	
Communication Controller	Type	netX 100 processor	
Integrated Memory	RAM	8 MB SDRAM	
	FLASH	4 MB serial Flash EPROM	
	Size of the Dual-Port Memory	64 KByte	
	MRAM (only CIFX 90E-DN\MR\F and CIFX 90E-DN\ET\F)	128Kbyte (= 64K Words); <b>Note:</b> Using the cifX Device Driver (from Version 1.1.1.0) access to this memory is possible and it can be used as a remanent memory.	
System Interface	Bus Type	Mini PCI Express One Lane Port, according to [bus spec 2] and [bus spec 6], refer to section <i>Overview</i> , page 132 and <i>Pin Assignment for Mini PCI Express Bus / SYNC Connector (Bootstart), X1/X2</i> , page 135.	
	Transmission Rate	33 MHz	
	Data Access	DPM or DMA* (Direct Memory Access); * CIFX 90E-CC\ET\F and CIFX 90E-CC\MR\ET\F from Hardware Revision 1	
	Width for the data access to the Dual-Port Memory (DPM)	32-Bit	
CC-Link Communication	Supported communication standard/ protocol (determined by the loaded firmware)	CC-Link Slave	
CC-Link interface	Transmission Rate	156 kBit/s, 625 kBit/s, 2500 kBit/s, 5 MBit/s, 10 MBit/s	
	Interface Type	RS-485, refer to section <i>CC-Link Interface</i> , page 126.	
	CC-Link Assembly Interface	AIFX-CC, refer to section <i>AIFX-CC</i> , page 195. <b>Important!</b> Operating the PC card CIFX 90E-CC\ET\F and. CIFX 90E-CC\MR\ET\F requires proper connection of the CC-Link assembly interface (AIFX-CC) to the basic card!	
	Connector AIFX-CC	Cable Connector Fieldbus X3 (JST 10FMN-BMT-A-TF(LF)(SN), Pitch 1,0 mm)	
Display	LED Display	<b>SYS</b> System Status LED	
		For LEDs at AIFX-CC, refer to section <i>AIFX-CC</i> , p. 195.	
Power supply	Supply Voltage	+3.3 V dc $\pm 5\%$ , refer to section <i>Power Supply and Host Interface</i> , page 46.	
	Maximum Current at at 3.3 V (typically)	600 mA	
	Connector	Via Mini PCI Express Bus	
Environmental Conditions		CIFX 90E-CC\ET\F, CIFX 90E-CC\MR\ET\F	
	Operating temperature range*	0 °C ... +60 °C	

CIFX 90E-CC\ET\F, CIFX 90E-CC\MR\ET\F	Parameter	Value
	Storage temperature range	-10 °C ... +70 °C
	*Air flow during measurement	0,5m/s
	Humidity	10 ... 95% relative humidity, no condensation permitted
Device	Dimensions (L x W x H)	CIFX 90E-CC\ET\F, CIFX 90E-CC\MR\ET\F
		51 x 30,2 +/- 0,1 x 12,5 mm
		For details on the element heights refer to section <i>Notes on the Card Height - PC Card cifX Mini PCI and Mini PCIe</i> on page 44.
	Mounting/Installation	PCI Express Mini System Connector (3.3 V), X1/X2 <sup>13</sup> = One Lane, refer to section <i>Slot for the PC Cards cifX Compact PCI, Mini PCI, Mini PCIe, PCI-104</i> , page 43.
	RoHS	Yes
CE Sign	CE Sign	Yes
	Emission	EN 55011:2009 + A1:2010, CISPR 11:2009, Class A (Radio disturbance characteristics - Limits and methods of measurement)
	Immunity	EN 61000-4-2:2009 (Electrostatic discharge test) EN 61000-4-3:2006 + A1:2008 + A2:2010 (Radiated, radio-frequency, electromagnetic field test) EN 61000-4-4:2004 + A1:2010 (Burst Electrical fast transients/burst test) EN 61000-4-5:2006 (Surge test) EN 61000-4-6:2009 (to conducted disturbances, induced by radio- frequency fields) EN 61000-4-8:2010 (power frequency magnetic field test) EN 61000-6-2:2005 + B1:2011 (for industrial environments)
Configuration	Configuration Software	SYCON.net or netX Configuration Tool

Table 130: Technical Data CIFX 90E-CC\ET\F, CIFX 90E-CC\MR\ET\F

### 10.1.15 CIFX 90E-2DP\ET\F, CIFX 90E-2DP\MR\ET\F

CIFX 90E-2DP\ET\F, CIFX 90E-2DP\MR\ET\F	Parameter	Value
Part	Name	CIFX 90E-2DP\ET\F      CIFX 90E-2DP\MR\ET\F
	Part No.	1293.414      1293.416
	Description	PC Card cifX Mini PCI Express with 2 channels PROFIBUS DP Master or Slave (as variants with additional MRAM ‚MR‘ and enlarged temperature range ‚ET‘) composed of: - Basic card CIFX 90E-2FB\ET or CIFX 90E-2FB\MR\ET with cable connector Fieldbus X3 and X4, - PROFIBUS assembly interface (AIFX-DP). <b>Note:</b> The device height and the power input of the PC Card Mini PCI Express CIFX 90E-2DP\ET\F and CIFX 90E-2DP\MR\ET\F do not comply with the standard specifications.
	Function	Communication Interface with Mini PCI Express and 2 x PROFIBUS interface
Communication Controller	Type	netX 100 processor

<sup>13</sup> X1, X2 corresponds to the Hilscher convention for „interface“ on the top or the bottom side of the PC Card cifX.

CIFX 90E-2DP\ET\F, CIFX 90E-2DP\MR\ET\F	Parameter	Value
Integrated Memory	RAM	8 MB SDRAM
	FLASH	4 MB serial Flash EPROM
	Size of the Dual-Port Memory	64 KByte
	MRAM (only CIFX 90E-2DP\MR\ET\F)	128Kbyte (= 64K Words); <b>Note:</b> Using the cifX Device Driver (from Version 1.1.1.0) access to this memory is possible and it can be used as a remanent memory.
System Interface	Bus Type	Mini PCI Express One Lane Port, according to [bus spec 2] and [bus spec 6], refer to section <i>Overview</i> , page 132 and <i>Pin Assignment for Mini PCI Express Bus / SYNC Connector (Bootstart), X1/X2</i> , page 135.
	Transmission Rate	33 MHz
	Data Access	DPM or DMA (Direct Memory Access)
	Width for the data access to the Dual-Port Memory (DPM)	32-Bit
PROFIBUS Communication	Supported communication standard/ protocol (determined by the loaded firmware)	PROFIBUS DP Master, PROFIBUS DP Slave
PROFIBUS interface	Transmission Rate	9,6 kBit/s, 19,2 kBit/s, 31,25 kBit/s, 45,45 kBit/s, 93,75 kBit/s, 187,5 kBit/s, 500 kBit/s, 1,5 MBit/s, 3 MBit/s, 6 MBit/s, 12 MBit/s
	Interface Type	RS 485, refer to section <i>PROFIBUS Interface</i> page 125.
	PROFIBUS Assembly Interface	AIFX-DP, refer to section <i>AIFX-DP</i> page 192. <b>Important!</b> Operating the PC card CIFX 90E-2DP\ET\F or CIFX 90E-2DP\MR\ET\F requires proper connection of both PROFIBUS assembly interfaces (AIFX-DP) to the basic card!
	Connector AIFX-DP	Cable Connector Fieldbus <b>X3</b> and <b>X4</b> (JST 10FMN-BMT-A-TF(LF)(SN), Pitch 1,0 mm)
Display	LED Display	<b>SYS</b> System Status LED
		For LEDs at AIFX-DP, refer to section <i>AIFX-DP</i> page 192.
Power supply	Supply Voltage	+3.3 V dc $\pm 5\%$ , refer to section <i>Power Supply and Host Interface</i> , page 46.
	Maximum Current at at 3.3 V (typically)	770 mA (preliminary value)
	Connector	Via Mini PCI Express Bus
Environmental Conditions		CIFX 90E-2DP\ET\F, CIFX 90E-2DP\MR\ET\F
	Operating temperature range*	-20 °C ... +70 °C
	Storage temperature range	-10 °C ... +70 °C
	*Air flow during measurment	0,5m/s
Device	Dimensions (L x W x H)	10 ... 95% relative humidity, no condensation permitted
		CIFX 90E-2DP\ET\F, CIFX 90E-2DP\MR\ET\F
		51 x 30,2 +/- 0,1 x 12,5 mm
	Mounting/Installation	For details on the element hights refer to section <i>Notes on the Card Height - PC Card cifX Mini PCI and Mini PCIe</i> on page 44.
		PCI Express Mini System Connector (3.3 V), X1/X2 <sup>14</sup> = One Lane, refer to section <i>Slot for the PC Cards cifX Compact PCI, Mini PCI, Mini PCIe, PCI-104</i> , page 43.
RoHS		Yes

<sup>14</sup> X1, X2 corresponds to the Hilscher convention for „interface“ on the top or the bottom side of the PC Card cifX.

CIFX 90E-2DP\ET\F, CIFX 90E-2DP\MR\ET\F	Parameter	Value
CE Sign	CE Sign	Yes
	Emission	EN 55011:2009 + A1:2010, CISPR 11:2009, Class A (Radio disturbance characteristics - Limits and methods of measurement)
	Immunity	EN 61000-4-2:2009 (Electrostatic discharge test) EN 61000-4-3:2006 + A1:2008 + A2:2010 (Radiated, radio-frequency, electromagnetic field test) EN 61000-4-4:2004 + A1:2010 (Burst Electrical fast transients/burst test) EN 61000-4-5:2006 (Surge test) EN 61000-4-6:2009 (to conducted disturbances, induced by radio- frequency fields) EN 61000-4-8:2010 (power frequency magnetic field test) EN 61000-6-2:2005 + B1:2011 (for industrial environments)
Configuration	Configuration Software Master and Slave	SYCON.net
	Configuration Software Slave	netX Configuration Tool

Table 131: Technical Data CIFX 90E-2DP\ET\F, CIFX 90E-2DP\MR\ET\F

### 10.1.16 CIFX 90E-2DP\CO\ET\F, CIFX 90E-2DP\COMR\ET\F

CIFX 90E-2DP\CO\ET\F, CIFX 90E-2DP\COMR\ET\F	Parameter	Value
Part	Name	CIFX 90E-2DP\CO\ET\F
	Part No.	1293.474
	Description	PC Card cifX Mini PCI Express with 2 channels - Channel X1: PROFIBUS DP Master or Slave, Channel X2: CANopen Master or Slave (as variants with additional MRAM ,MR' and enlarged temperature range ,ET') composed of: - Basic card CIFX 90E-2FB\ET or CIFX 90E-2FB\MR\ET with cable connector Fieldbus X3 and X4, - PROFIBUS assembly interface (AIFX-DP) and - CANopen assembly interface (AIFX-CO). <b>Note:</b> The device height and the power input of the PC Card Mini PCI Express CIFX 90E-2DP\CO\ET\F and CIFX 90E-2DP\COMR\ET\F do not comply with the standard specifications.
	Function	Communication Interface with Mini PCI Express, 1 x PROFIBUS interface and 1x CANopen interface
Communication Controller	Type	netX 100 processor
Integrated Memory	RAM	8 MB SDRAM
	FLASH	4 MB serial Flash EPROM
	Size of the Dual-Port Memory	64 KByte
	MRAM (only CIFX 90E-2DP\CO\MR\ET\F)	128Kbyte (= 64K Words); <b>Note:</b> Using the cifX Device Driver (from Version 1.1.1.0) access to this memory is possible and it can be used as a remanent memory.
System Interface	Bus Type	Mini PCI Express One Lane Port, according to [bus spec 2] and [bus spec 6], refer to section <i>Overview</i> , page 132 and <i>Pin Assignment for Mini PCI Express Bus / SYNC Connector (Bootstart)</i> , X1/X2, page 135.
	Transmission Rate	33 MHz
	Data Access	DPM or DMA (Direct Memory Access)
	Width for the data access to the	32-Bit

CIFX 90E-2DP\CO\ET\F, CIFX 90E-2DP\CO\MR\ET\F	Parameter	Value
	Dual-Port Memory (DPM)	
PROFIBUS Communication	Supported communication standard/ protocol (determined by the loaded firmware)	PROFIBUS DP Master, PROFIBUS DP Slave
PROFIBUS interface	Transmission Rate	9,6 kBit/s, 19,2 kBit/s, 31,25 kBit/s, 45,45 kBit/s, 93,75 kBit/s, 187,5 kBit/s, 500 kBit/s, 1,5 MBit/s, 3 MBit/s, 6 MBit/s, 12 MBit/s
	Interface Type	RS 485, refer to section <i>PROFIBUS Interface</i> page 125.
	PROFIBUS Assembly Interface	AIFX-DP, refer to section <i>AIFX-DP</i> page 192. <b>Important!</b> Operating the PC card CIFX 90E-2DP\CO\ET\F or CIFX 90E-2DP\CO\MR\ET\F requires proper connection of the PROFIBUS assembly interface (AIFX-DP) and of the CANopen assembly interface (AIFX-CO) to the basic card!
	Connector AIFX-DP	Cable Connector Fieldbus <b>X3</b> (JST 10FMN-BMT-A-TF(LF)(SN), Pitch 1,0 mm)
CANopen Communication	Supported communication standard/ protocol (determined by the loaded firmware)	CANopen Master, CANopen Slave
CANopen Interface	Transmission rate	10 kBit/s, 20 kBit/s, 50 kBit/s, 100 kBit/s, 125 kBit/s, 250 kBit/s, 500 kBit/s, 800 kBit/s, 1 MBit/s
	Interface Type	ISO-11898, refer to section <i>CANopen Interface</i> , page 125.
	CANopen Assembly Interface	AIFX-CO, refer to section <i>AIFX-CO</i> , page 193. <b>Important!</b> Operating the PC card CIFX 90E-2DP\CO\ET\F or CIFX 90E-2DP\CO\MR\ET\F requires proper connection of the PROFIBUS assembly interface (AIFX-DP) and of the CANopen assembly interface (AIFX-CO) to the basic card!
	Connector AIFX-CO	Connector Fieldbus <b>X4</b> (JST 10FMN-SMT-A-TF(LF)(SN), Pitch 1,0 mm)
Display	LED Display	<b>SYS</b> System Status LED
		For the LEDs at AIFX-DP at channel X1, refer to section <i>AIFX-DP</i> page 192. For the LEDs at AIFX-CO at channel X2, refer to section <i>AIFX-CO</i> , page 193.
Power supply	Supply Voltage	+3.3 V dc $\pm 5\%$ , refer to section <i>Power Supply and Host Interface</i> , page 46.
	Maximum Current at at 3.3 V (typically)	770 mA (preliminary value)
	Connector	Via Mini PCI Express Bus
Environmental Conditions		CIFX 90E-2DP\CO\ET\F, CIFX 90E-2DP\CO\MR\ET\F
	Operating temperature range*	-20 °C ... +70 °C
	Storage temperature range	-10 °C ... +70 °C
	*Air flow during measurement	0,5m/s
	Humidity	10 ... 95% relative humidity, no condensation permitted
Device	Dimensions (L x W x H)	CIFX 90E-2DP\CO\ET\F, CIFX 90E-2DP\CO\MR\ET\F
		51 x 30,2 +/- 0,1 x 12,5 mm
		For details on the element heights refer to section <i>Notes on the Card Height - PC Card cifX Mini PCI and Mini PCIe</i> on page 44.
	Mounting/Installation	PCI Express Mini System Connector (3.3 V), X1/X2 <sup>15</sup> = One Lane, refer to section <i>Slot for the PC Cards cifX Compact PCI, Mini PCI, Mini PCIe, PCI-104</i> , page 43.

<sup>15</sup> X1, X2 corresponds to the Hilscher convention for „interface“ on the top or the bottom side of the PC Card cifX.

CIFX 90E-2DP\CO\ET\F, CIFX 90E-2DP\COM\RI\ET\F	Parameter	Value
	RoHS	Yes
CE Sign	CE Sign	Yes
	Emission	EN 55011:2009 + A1:2010, CISPR 11:2009, Class A (Radio disturbance characteristics - Limits and methods of measurement)
	Immunity	EN 61000-4-2:2009 (Electrostatic discharge test) EN 61000-4-3:2006 + A1:2008 + A2:2010 (Radiated, radio-frequency, electromagnetic field test) EN 61000-4-4:2004 + A1:2010 (Burst Electrical fast transients/burst test) EN 61000-4-5:2006 (Surge test) EN 61000-4-6:2009 (to conducted disturbances, induced by radio- frequency fields) EN 61000-4-8:2010 (power frequency magnetic field test) EN 61000-6-2:2005 + B1:2011 (for industrial environments)
Configuration	Configuration Software Master and Slave	SYCON.net
	Configuration Software Slave	netX Configuration Tool

Table 132: Technical Data CIFX 90E-2DP\CO\ET\F, CIFX 90E-2DP\COM\RI\ET\F

### 10.1.17 CIFX 90E-2DP\DN\ET\F, CIFX 90E-2DP\DN\MR\ET\F

CIFX 90E-2DP\DN\ET\F, CIFX 90E-2DP\DN\MR\ET\F	Parameter	Value
Part	Name	CIFX 90E-2DP\DN\ET\F      CIFX 90E-2DP\DN\MR\ET\F
	Part No.	1293.484      1293.486
	Description	PC Card cifX Mini PCI Express with 2 channels - Channel X1: PROFIBUS DP Master or Slave, Channel X2: DeviceNet Master or Slave (as variants with additional MRAM ,MR' and enlarged temperature range ,ET') composed of: - Basic card CIFX 90E-2FB\ET or CIFX 90E-2FB\MR\ET with cable connector Fieldbus X3 and X4, - PROFIBUS assembly interface (AIFX-DP) and - DeviceNet assembly interface (AIFX-DN). <b>Note:</b> The device height and the power input of the PC Card Mini PCI Express CIFX 90E-2DP\DN\ET\F and CIFX 90E-2DP\DN\MR\ET\F do not comply with the standard specifications.
	Function	Communication Interface with Mini PCI Express, 1 x PROFIBUS interface and 1x DeviceNet interface
Communication Controller	Type	netX 100 processor
Integrated Memory	RAM	8 MB SDRAM
	FLASH	4 MB serial Flash EPROM
	Size of the Dual-Port Memory	64 KByte
	MRAM (only CIFX 90E-2DP\DN\MR\ET\F)	128Kbyte (= 64K Words); <b>Note:</b> Using the cifX Device Driver (from Version 1.1.1.0) access to this memory is possible and it can be used as a remanent memory.
System Interface	Bus Type	Mini PCI Express One Lane Port, according to [bus spec 2] and [bus spec 6], refer to section <i>Overview</i> , page 132 and <i>Pin Assignment for Mini PCI Express Bus / SYNC Connector (Bootstart)</i> , X1/X2, page 135.
	Transmission Rate	33 MHz
	Data Access	DPM or DMA (Direct Memory Access)

CIFX 90E-2DP\DN\ET\F, CIFX 90E-2DP\DN\MR\ET\F	Parameter	Value
	Width for the data access to the Dual-Port Memory (DPM)	32-Bit
PROFIBUS Communication	Supported communication standard/ protocol (determined by the loaded firmware)	PROFIBUS DP Master, PROFIBUS DP Slave
PROFIBUS interface	Transmission Rate	9,6 kBit/s, 19,2 kBit/s, 31,25 kBit/s, 45,45 kBit/s, 93,75 kBit/s, 187,5 kBit/s, 500 kBit/s, 1,5 MBit/s, 3 MBit/s, 6 MBit/s, 12 MBit/s
	Interface Type	RS 485, refer to section <i>PROFIBUS Interface</i> page 125.
	PROFIBUS Assembly Interface	AIFX-DP, refer to section <i>AIFX-DP</i> page 192. <b>Important!</b> Operating the PC card CIFX 90E-2DP\DN\ET\F or CIFX 90E-2DP\DN\MR\ET\F requires proper connection of the PROFIBUS assembly interface (AIFX-DP) and of the DeviceNet assembly interface (AIFX-DN) to the basic card!
	Connector AIFX-DP	Cable Connector Fieldbus <b>X3</b> (JST 10FMN-BMT-A-TF(LF)(SN), Pitch 1,0 mm)
DeviceNet Communication	Supported communication standard/ protocol (determined by the loaded firmware)	DeviceNet Master, DeviceNet Slave
DeviceNet Interface	Transmission rate	125 kBit/s, 250 kBit/s, 500 kBit/s
	Interface Type	ISO-11898 according to DeviceNet specification, refer to section <i>DeviceNet Interface</i> , page 126
	DeviceNet Assembly Interface	AIFX-DN, refer to section <i>AIFX-DN</i> , page 194. <b>Important!</b> Operating the PC card CIFX 90E-2DP\DN\ET\F or CIFX 90E-2DP\DN\MR\ET\F requires proper connection of the PROFIBUS assembly interface (AIFX-DP) and of the DeviceNet assembly interface (AIFX-DN) to the basic card!
	Connector AIFX-DN	Connector Fieldbus <b>X4</b> (JST 10FMN-SMT-A-TF(LF)(SN), Pitch 1,0 mm)
Display	LED Display	<b>SYS</b> System Status LED
		For the LEDs at AIFX-DP at channel X1, refer to section <i>AIFX-DP</i> page 192. For the LEDs at AIFX-DN at channel X2, refer to section <i>AIFX-DN</i> , page 194.
Power supply	Supply Voltage	+3.3 V dc $\pm$ 5 %, refer to section <i>Power Supply and Host Interface</i> , page 46.
	Maximum Current at at 3.3 V (typically)	770 mA (preliminary value)
	Connector	Via Mini PCI Express Bus
Environmental Conditions		CIFX 90E-2DP\DN\ET\F, CIFX 90E-2DP\DN\MR\ET\F
	Operating temperature range*	-20 °C ... +70 °C
	Storage temperature range	-10 °C ... +70 °C
	*Air flow during measurement	0,5m/s
	Humidity	10 ... 95% relative humidity, no condensation permitted
Device	Dimensions (L x W x H)	CIFX 90E-2DP\DN\ET\F, CIFX 90E-2DP\DN\MR\ET\F
		51 x 30,2 +/- 0,1 x 12,5 mm
		For details on the element heights refer to section <i>Notes on the Card Height - PC Card cifX Mini PCI and Mini PCIe</i> on page 44.



CIFX 90E-2DPIDNETF, CIFX 90E-2DPIDNMR\ET\F	Parameter	Value
	Mounting/Installation	PCI Express Mini System Connector (3.3 V), X1/X2 <sup>16</sup> = One Lane, refer to section <i>Slot for the PC Cards cifX Compact PCI, Mini PCI, Mini PCIe, PCI-104</i> , page 43.
	RoHS	Yes
CE Sign	CE Sign	Yes
	Emission	EN 55011:2009 + A1:2010, CISPR 11:2009, Class A (Radio disturbance characteristics - Limits and methods of measurement)
	Immunity	EN 61000-4-2:2009 (Electrostatic discharge test) EN 61000-4-3:2006 + A1:2008 + A2:2010 (Radiated, radio-frequency, electromagnetic field test) EN 61000-4-4:2004 + A1:2010 (Burst Electrical fast transients/burst test) EN 61000-4-5:2006 (Surge test) EN 61000-4-6:2009 (to conducted disturbances, induced by radio- frequency fields) EN 61000-4-8:2010 (power frequency magnetic field test) EN 61000-6-2:2005 + B1:2011 (for industrial environments)
Configuration	Configuration Software Master and Slave	SYCON.net
	Configuration Software Slave	netX Configuration Tool

Table 133: Technical Data CIFX 90E-2DPIDNETF, CIFX 90E-2DPIDNMR\ET\F

### 10.1.18 CIFX 90E-2CO\ET\F, CIFX 90E-2COMR\ET\F

CIFX 90E-2CO\ET\F, CIFX 90E-2COMR\ET\F	Parameter	Value
Part	Name	CIFX 90E-2CO\ET\F      CIFX 90E-2COMR\ET\F
	Part No.	1293.504      1293.506
	Description	PC Card cifX Mini PCI Express with 2 channels CANopen Master or Slave (as variants with additional MRAM ,MR' and enlarged temperature range ,ET') composed of: - Basic card CIFX 90E-2FB\ET or CIFX 90E-2FB\MR\ET with cable connector Fieldbus X3 and X4, - CANopen assembly interface (AIFX-CO). <b>Note:</b> The device height and the power input of the PC Card Mini PCI Express CIFX 90E-2CO\ET\F and CIFX 90E-2COMR\ET\F do not comply with the standard specifications.
	Function	Communication Interface with Mini PCI Express and 2 x CANopen interface
Communication Controller	Type	netX 100 processor
Integrated Memory	RAM	8 MB SDRAM
	FLASH	4 MB serial Flash EPROM
	Size of the Dual-Port Memory	64 KByte
	MRAM (only CIFX 90E-2COMR\ET\F)	128Kbyte (= 64K Words); <b>Note:</b> Using the cifX Device Driver (from Version 1.1.1.0) access to this memory is possible and it can be used as a remanent memory.
System Interface	Bus Type	Mini PCI Express One Lane Port, according to [bus spec 2] and [bus spec 6], refer to section <i>Overview</i> , page

<sup>16</sup> X1, X2 corresponds to the Hilscher convention for „interface“ on the top or the bottom side of the PC Card cifX.

CIFX 90E-2CO\ET\F, CIFX 90E-2CO\MR\ET\F	Parameter	Value
		132 and Pin Assignment for Mini PCI Express Bus / SYNC Connector (Bootstart), X1/X2, page 135.
	Transmission Rate	33 MHz
	Data Access	DPM or DMA (Direct Memory Access)
	Width for the data access to the Dual-Port Memory (DPM)	32-Bit
CANopen Communication	Supported communication standard/ protocol (determined by the loaded firmware)	CANopen Master, CANopen Slave
CANopen Interface	Transmission rate	10 kBit/s, 20 kBit/s, 50 kBit/s, 100 kBit/s, 125 kBit/s, 250 kBit/s, 500 kBit/s, 800 kBit/s, 1 MBit/s
	Interface Type	ISO-11898, refer to section <i>CANopen Interface</i> , page 125.
	CANopen Assembly Interface	AIFX-CO, refer to section <i>AIFX-CO</i> , page 193. <b>Important!</b> Operating the PC card CIFX 90E-2CO\ET\F or CIFX 90E-2CO\MR\ET\F requires proper connection of both CANopen assembly interfaces (AIFX-CO) to the basic card!
	Connector AIFX-CO	Connector Fieldbus <b>X3</b> and <b>X4</b> (JST 10FMN-SMT-A-TF(LF)(SN), Pitch 1,0 mm)
Display	LED Display	<b>SYS</b> System Status LED
		For LEDs at AIFX-CO, refer to section <i>AIFX-CO</i> , page 193.
Power supply	Supply Voltage	+3.3 V dc $\pm 5\%$ , refer to section <i>Power Supply and Host Interface</i> , page 46.
	Maximum Current at at 3.3 V (typically)	770 mA (preliminary value)
	Connector	Via Mini PCI Express Bus
Environmental Conditions		CIFX 90E-2CO\ET\F, CIFX 90E-2CO\MR\ET\F
	Operating temperature range*	-20 °C ... +70 °C
	Storage temperature range	-10 °C ... +70 °C
	*Air flow during measurement	0,5m/s
	Humidity	10 ... 95% relative humidity, no condensation permitted
Device	Dimensions (L x W x H)	CIFX 90E-2CO\ET\F, CIFX 90E-2CO\MR\ET\F
		51 x 30,2 +/- 0,1 x 12,5 mm
		For details on the element heights refer to section <i>Notes on the Card Height - PC Card cifX Mini PCI and Mini PCIe</i> on page 44.
	Mounting/Installation	PCI Express Mini System Connector (3.3 V), X1/X2 <sup>17</sup> = One Lane, refer to section <i>Slot for the PC Cards cifX Compact PCI, Mini PCI, Mini PCIe, PCI-104</i> , page 43.
	RoHS	Yes
CE Sign	CE Sign	Yes
	Emission	EN 55011:2009 + A1:2010, CISPR 11:2009, Class A (Radio disturbance characteristics - Limits and methods of measurement)
	Immunity	EN 61000-4-2:2009 (Electrostatic discharge test) EN 61000-4-3:2006 + A1:2008 + A2:2010 (Radiated, radio-frequency, electromagnetic field test) EN 61000-4-4:2004 + A1:2010 (Burst Electrical fast transients/burst test)

<sup>17</sup> X1, X2 corresponds to the Hilscher convention for „interface“ on the top or the bottom side of the PC Card cifX.

CIFX 90E-2CO\ET\F, CIFX 90E-2CO\MR\ET\F	Parameter	Value
		EN 61000-4-5:2006 (Surge test) EN 61000-4-6:2009 (to conducted disturbances, induced by radio- frequency fields) EN 61000-4-8:2010 (power frequency magnetic field test) EN 61000-6-2:2005 + B1:2011 (for industrial environments)
Configuration	Configuration Software Master and Slave	SYCON.net
	Configuration Software Slave	netX Configuration Tool

Table 134: Technical Data CIFX 90E-2CO\ET\F, CIFX 90E-2COWR\ET\F

### 10.1.19 CIFX 90E-2CO\DN\ET\F, CIFX 90E-2CO\DN\MR\ET\F

CIFX 90E-2CO\DN\ET\F, CIFX 90E-2CO\DN\MR\ET\F	Parameter	Value
Part	Name	CIFX 90E-2CO\DN\ET\F    CIFX 90E-2CO\DN\MR\ET\F
	Part No.	1293.574                      1293.576
	Description	PC Card cifX Mini PCI Express with 2 channels - Channel X1: CANopen Master or Slave, Channel X2: DeviceNet Master or Slave (as variants with additional MRAM ,MR' and enlarged temperature range ,ET') composed of: - Basic card CIFX 90E-2FB\ET or CIFX 90E-2FB\MR\ET with cable connector Fieldbus X3 and X4, - CANopen assembly interface (AIFX-DP) and - DeviceNet assembly interface (AIFX-DN). <b>Note:</b> The device height and the power input of the PC Card Mini PCI Express CIFX 90E-2CO\DN\ET\F and CIFX 90E-2CO\DN\MR\ET\F do not comply with the standard specifications.
	Function	Communication Interface with Mini PCI Express, 1 x CANopen interface and 1x DeviceNet interface
Communication Controller	Type	netX 100 processor
Integrated Memory	RAM	8 MB SDRAM
	FLASH	4 MB serial Flash EPROM
	Size of the Dual-Port Memory	64 KByte
	MRAM (only CIFX 90E-2CO\DN\MR\ET\F)	128Kbyte (= 64K Words); <b>Note:</b> Using the cifX Device Driver (from Version 1.1.1.0) access to this memory is possible and it can be used as a remanent memory.
System Interface	Bus Type	Mini PCI Express One Lane Port, according to [bus spec 2] and [bus spec 6], refer to section <i>Overview</i> , page 132 and <i>Pin Assignment for Mini PCI Express Bus / SYNC Connector (Bootstart), X1/X2</i> , page 135.
	Transmission Rate	33 MHz
	Data Access	DPM or DMA (Direct Memory Access)
	Width for the data access to the Dual-Port Memory (DPM)	32-Bit
CANopen Communication	Supported communication standard/ protocol (determined by the loaded firmware)	CANopen Master, CANopen Slave
CANopen Interface	Transmission rate	10 kBit/s, 20 kBit/s, 50 kBit/s, 100 kBit/s, 125 kBit/s, 250 kBit/s, 500 kBit/s, 800 kBit/s, 1 MBit/s
	Interface Type	ISO-11898, refer to section <i>CANopen Interface</i> , page 125.
	CANopen Assembly Interface	AIFX-CO, refer to section <i>AIFX-CO</i> , page 193.

CIFX 90E-2CO\DN\ET\F, CIFX 90E-2CO\DN\MR\ET\F	Parameter	Value
		<b>Important!</b> Operating the PC card CIFX 90E-2CO\DN\ET\F or CIFX 90E-2CO\DN\MR\ET\F requires proper connection of the CANopen assembly interface (AIFX-CO) and of the DeviceNet assembly interface (AIFX-DN) to the basic card!
	Connector AIFX-CO	Connector Fieldbus <b>X3</b> (JST 10FMN-SMT-A-TF(LF)(SN), Pitch 1,0 mm)
DeviceNet Communication	Supported communication standard/ protocol (determined by the loaded firmware)	DeviceNet Master, DeviceNet Slave
DeviceNet Interface	Transmission rate	125 kBit/s, 250 kBit/s, 500 kBit/s
	Interface Type	ISO-11898 according to DeviceNet specification, refer to section <i>DeviceNet Interface</i> , page 126
	DeviceNet Assembly Interface	AIFX-DN, refer to section <i>AIFX-DN</i> , page 194. <b>Important!</b> Operating the PC card CIFX 90E-2CO\DN\ET\F or CIFX 90E-2CO\DN\MR\ET\F requires proper connection of the CANopen assembly interface (AIFX-CO) and of the DeviceNet assembly interface (AIFX-DN) to the basic card!
	Connector AIFX-DN	Connector Fieldbus <b>X4</b> (JST 10FMN-SMT-A-TF(LF)(SN), Pitch 1,0 mm)
Display	LED Display	<b>SYS</b> System Status LED For the LEDs at AIFX-Co at channel X1, refer to section <i>AIFX-CO</i> , page 193. For the LEDs at AIFX-DN at channel X2, refer to section <i>AIFX-DN</i> , page 194.
Power supply	Supply Voltage	+3.3 V dc $\pm 5\%$ , refer to section <i>Power Supply and Host Interface</i> , page 46.
	Maximum Current at at 3.3 V (typically)	770 mA (preliminary value)
	Connector	Via Mini PCI Express Bus
Environmental Conditions		CIFX 90E-2CO\DN\ET\F, CIFX 90E-2CO\DN\MR\ET\F
	Operating temperature range*	-20 °C ... +70 °C
	Storage temperature range	-10 °C ... +70 °C
	*Air flow during measurement	0,5m/s
	Humidity	10 ... 95% relative humidity, no condensation permitted
Device	Dimensions (L x W x H)	CIFX 90E-2CO\DN\ET\F, CIFX 90E-2CO\DN\MR\ET\F
		51 x 30,2 +/- 0,1 x 12,5 mm
		For details on the element heights refer to section <i>Notes on the Card Height - PC Card cifX Mini PCI and Mini PCIe</i> on page 44.
	Mounting/Installation	PCI Express Mini System Connector (3.3 V), X1/X2 <sup>18</sup> = One Lane, refer to section <i>Slot for the PC Cards cifX Compact PCI, Mini PCI, Mini PCIe, PCI-104</i> , page 43.
	RoHS	Yes
CE Sign	CE Sign	Yes
	Emission	EN 55011:2009 + A1:2010, CISPR 11:2009, Class A (Radio disturbance characteristics - Limits and methods of measurement)
	Immunity	EN 61000-4-2:2009 (Electrostatic discharge test) EN 61000-4-3:2006 + A1:2008 + A2:2010 (Radiated, radio-frequency, electromagnetic field test)

<sup>18</sup> X1, X2 corresponds to the Hilscher convention for „interface“ on the top or the bottom side of the PC Card cifX.

CIFX 90E-2CO\DN\ET\F, CIFX 90E-2CO\DN\MR\ET\F	Parameter	Value
		EN 61000-4-4:2004 + A1:2010 (Burst Electrical fast transients/burst test) EN 61000-4-5:2006 (Surge test) EN 61000-4-6:2009 (to conducted disturbances, induced by radio- frequency fields) EN 61000-4-8:2010 (power frequency magnetic field test) EN 61000-6-2:2005 + B1:2011 (for industrial environments)
Configuration	Configuration Software Master and Slave	SYCON.net
	Configuration Software Slave	netX Configuration Tool

Table 135: Technical Data CIFX 90E-2CO\DN\ET\F, CIFX 90E-2CO\DN\MR\ET\F

### 10.1.20 CIFX 90E-2DN\ET\F, CIFX 90E-2DN\MR\ET\F

CIFX 90E-2DN\ET\F, CIFX 90E-2DN\MR\ET\F	Parameter	Value
Part	Name	CIFX 90E-2DN\ET\F      CIFX 90E-2DN\MR\ET\F
	Part No.	1293.514      1293.516
	Description	PC Card cifX Mini PCI Express with 2 channels DeviceNet Master or Slave (as variants with additional MRAM ,MR' and enlarged temperature range ,ET') composed of: - Basic card CIFX 90E-2FB\ET or CIFX 90E-2FB\MR\ET with cable connector Fieldbus X3 and X4, - DeviceNet assembly interface (AIFX-DN).  <b>Note:</b> The device height and the power input of the PC Card Mini PCI Express CIFX 90E-2DN\ET\F and CIFX 90E-2DN\MR\ET\F do not comply with the standard specifications.
	Function	Communication Interface with Mini PCI Express and 2 x DeviceNet interface
Communication Controller	Type	netX 100 processor
Integrated Memory	RAM	8 MB SDRAM
	FLASH	4 MB serial Flash EPROM
	Size of the Dual-Port Memory	64 KByte
	MRAM (only CIFX 90E-2DN\MR\ET\F F)	128Kbyte (= 64K Words); <b>Note:</b> Using the cifX Device Driver (from Version 1.1.1.0) access to this memory is possible and it can be used as a remanent memory.
System Interface	Bus Type	Mini PCI Express One Lane Port, according to [bus spec 2] and [bus spec 6], refer to section <i>Overview</i> , page 132 and <i>Pin Assignment for Mini PCI Express Bus / SYNC Connector (Bootstart)</i> , X1/X2, page 135.
	Transmission Rate	33 MHz
	Data Access	DPM or DMA (Direct Memory Access)
	Width for the data access to the Dual-Port Memory (DPM)	32-Bit
DeviceNet Communication	Supported communication standard/ protocol (determined by the loaded firmware)	DeviceNet Master, DeviceNet Slave
DeviceNet Interface	Transmission rate	125 kBit/s, 250 kBit/s, 500 kBit/s
	Interface Type	ISO-11898 according to DeviceNet specification, refer to section <i>DeviceNet Interface</i> , page 126
	DeviceNet Assembly Interface	AIFX-DN, refer to section <i>AIFX-DN</i> , page 194. <b>Important!</b> Operating the PC card CIFX 90E-2DN\ET\F or CIFX

CIFX 90E-2DN\ET\F, CIFX 90E-2DN\MR\ET\F	Parameter	Value
		90E-2DN\MR\ET\F requires proper connection of both DeviceNet assembly interfaces (AIFX-DN) to the basic card!
	Connector AIFX-DN	Connector Fieldbus <b>X3</b> and <b>X4</b> (JST 10FMN-SMT-A-TF(LF)(SN), Pitch 1,0 mm)
Display	LED Display	<b>SYS</b> System Status LED
		For LED at AIFX-DN, refer to section <i>AIFX-DN</i> , p. 194.
Power supply	Supply Voltage	+3.3 V dc $\pm 5$ %, refer to section <i>Power Supply and Host Interface</i> , page 46.
	Maximum Current at at 3.3 V (typically)	770 mA (preliminary value)
	Connector	Via Mini PCI Express Bus
Environmental Conditions		CIFX 90E-2DN\ET\F, CIFX 90E-2DN\MR\ET\F
	Operating temperature range*	-20 °C ... +70 °C
	Storage temperature range	-10 °C ... +70 °C
	*Air flow during measurment	0,5m/s
Device	Dimensions (L x W x H)	CIFX 90E-2DN\ET\F, CIFX 90E-2DN\MR\ET\F
		51 x 30,2 +/- 0,1 x 12,5 mm
		For details on the element hights refer to section <i>Notes on the Card Height - PC Card cifX Mini PCI and Mini PCIe</i> on page 44.
	Mounting/Installation	PCI Express Mini System Connector (3.3 V), X1/X2 <sup>19</sup> = One Lane, refer to section <i>Slot for the PC Cards cifX Compact PCI, Mini PCI, Mini PCIe, PCI-104</i> , page 43.
	RoHS	Yes
CE Sign	CE Sign	Yes
	Emission	EN 55011:2009 + A1:2010, CISPR 11:2009, Class A (Radio disturbance characteristics - Limits and methods of measurement)
	Immunity	EN 61000-4-2:2009 (Electrostatic discharge test) EN 61000-4-3:2006 + A1:2008 + A2:2010 (Radiated, radio-frequency, electromagnetic field test) EN 61000-4-4:2004 + A1:2010 (Burst Electrical fast transients/burst test) EN 61000-4-5:2006 (Surge test) EN 61000-4-6:2009 (to conducted disturbances, induced by radio- frequency fields) EN 61000-4-8:2010 (power frequency magnetic field test) EN 61000-6-2:2005 + B1:2011 (for industrial environments)
Configuration	Configuration Software Master and Slave	SYCON.net
	Configuration Software Slave	netX Configuration Tool

Table 136: Technical Data CIFX 90E-2DN\ET\F, CIFX 90E-2DN\MR\ET\F

<sup>19</sup> X1, X2 corresponds to the Hilscher convention for „interface“ on the top or the bottom side of the PC Card cifX.

### 10.1.21 CIFX 104C-RE, CIFX 104C-RE-R

CIFX 104C-RE, CIFX 104C-RE-R	Parameter	Value	
Part	Name	CIFX 104C-RE	CIFX 104C-RE-R
	Part No.	1270.100	1271.100
	Description	PC Card cifX PCI-104 for Real-Time Ethernet Master or Slave; (for CIFX 104C-RE-R connectors at the left side)	
	Function	Communication Interface with PCI-104 and Ethernet interface	
Communication Controller	Type	netX 500 processor	
Integrated Memory	RAM	8 MB SDRAM	
	FLASH	4 MB serial Flash EPROM	
	Size of the Dual-Port Memory	64 KByte	
System Interface	Bus Type	PCI-104, according to [bus spec 7], refer to section <i>Overview</i> , page 132.	
	Transmission Rate	33 MHz	
	Data Access	DPM or DMA (Direct Memory Access)	
	Width for the data access to the Dual-Port Memory (DPM)	32-Bit	
Ethernet Communication	Supported Real-Time Ethernet communication systems (determined by the loaded firmware)	EtherCAT Master, EtherCAT Slave	
		EtherNet/IP Scanner (Master), EtherNet/IP Adapter (Slave),	
		Open Modbus/TCP	
		POWERLINK Controlled Node/Slave	
		PROFINET IO-Controller (Master), PROFINET IO-Device (Slave)	
		sercos Master, sercos Slave	
	VARAN Client (Slave)		
Ethernet Frame Types	Ethernet II		
Ethernet interface	Transmission Rate	100 MBit/s, 10 MBit/s (depending on loaded firmware)	
	Interface Type	100 BASE-TX, 10 BASE-T (depending on loaded firmware), refer to section <i>Ethernet Interface</i> , page 123.	
	Galvanic Isolation	isolated	
	Isolation Voltage	1000 VDC (tested for 1 minute)	
	Half duplex/Full duplex	depending on loaded firmware, supported (at 100 MBit/s)	
	Auto-Negotiation	depending on loaded firmware	
	Auto-Crossover	depending on loaded firmware	
	Connector	2* RJ45 Socket	
Channel 0 and 1	With loaded EtherCAT Master firmware only the RJ45 channel 0 can be used, channel 1 is deactivated. Beginning with the EtherCAT Master firmware version 3 channel 1 can be reactivated if redundancy is activated. For Open Modbus/TCP with V2.3.4.0 and higher both RJ45 channels can be used.		
Diagnosis Interface	USB Interface	Mini B USB Plug (5 pin), refer to section <i>Mini-B USB Connector (5 Pin)</i> , page 127.	

CIFX 104C-RE, CIFX 104C-RE-R	Parameter	Value
Display	LED Display	<p><b>SYS</b> System Status LED</p> <p>The meaning of the following LEDs depends on the loaded firmware:</p> <p><b>COM 0</b> LED Communication Status 0 (duo LED)</p> <p><b>COM 1</b> LED Communication Status 1 (duo LED)</p> <p><b>LED yellow</b> at RJ45Ch0 and RJ45Ch1, for Ethernet Link status, Ethernet Activity status and additional status</p> <p><b>LED green</b></p> <p>Refer to chapter <i>LED Descriptions</i>, page 94.</p>
Power supply	Supply Voltage	+5 V dc $\pm 5\%$ or +3.3 V dc $\pm 5\%$ , refer to section <i>Power Supply and Host Interface</i> , page 46.
	Maximum Current at at 5 V (typically) ..... or at 3.3 V (typically).....	500 mA  730 mA
	Connector	Via PCI-104 Bus
Operation	Rotary Switch PCI-104 Slot Number	To set the PCI-104 Slot Number, refer to section <i>Rotary Switch for PCI-104 Slot Number</i> , page 127.
	Rotary Switch Device Address	Is currently unassigned. Refer to section <i>Rotary Switch Device Address</i> on page 127.
Environmental Conditions	Operating temperature range*	0 °C ... +70 °C
	*Air flow during measurment	0,5m/s
	Storage temperature range	0 °C ... +70 °C
	Humidity	10 ... 95% relative humidity, no condensation permitted
	Environment	For UL compliant usage: The device must be used in a pollution degree 2 environment.
Device	Dimensions (L x W x H)	97 x 91 x 24 mm
	Mounting/Installation	PCI-104 Slot (Supply Voltage 5 V or 3.3 V, Signaling Voltage 5 V or 3.3 V), refer to section <i>Slot for the PC Cards cifX Compact PCI, Mini PCI, Mini PCIe, PCI-104</i> , page 43.
	RoHS	Yes
CE Sign	CE Sign	Yes
	Emission	EN 55011:2009 + A1:2010, CISPR 11:2009, Class A (Radio disturbance characteristics - Limits and methods of measurement)
	Immunity	EN 61000-4-2:2009 (Electrostatic discharge test) EN 61000-4-3:2006 + A1:2008 + A2:2010 (Radiated, radio-frequency, electromagnetic field test) EN 61000-4-4:2004 + A1:2010 (Burst Electrical fast transients/burst test) EN 61000-4-5:2006 (Surge test) EN 61000-4-6:2009 (to conducted disturbances, induced by radio- frequency fields) EN 61000-4-8:2010 (power frequency magnetic field test) EN 61000-6-2:2005 + B1:2011 (for industrial environments)
UL Certification	The device is certified according to UL 508	UL-File-Nr. E221530
Configuration	Configuration Software Master and Slave	SYCON.net



CIFX 104C-RE, CIFX 104C-RE-R	Parameter	Value
	Configuration Software Slave	netX Configuration Tool

Table 137: Technical Data CIFX 104C-RE, CIFX 104C-RE-R

### 10.1.22 CIFX 104C-RE\F, CIFX 104C-RE-R\F

CIFX 104C-RE\F, CIFX 104C-RE-R\F	Parameter	Value
Part	Name	CIFX 104C-RE\F      CIFX 104C-RE-R\F
	Part No.	1270.101      1271.101
	Description	PC Card cifX PCI-104 for Real-Time Ethernet Master or Slave composed of: - Basic card CIFX 104C-RE\F or CIFX 104C-RE-R\F* with cable connector Ethernet X304 (X4) and cable connector DIAG X303 (X3) (*connectors at the left side) - Ethernet assembly interface (AIFX-RE) and - diagnostic assembly interface (AIFX-DIAG).
	Function	Communication Interface with PCI-104 and Ethernet interface
Communication Controller	Type	netX 500 processor
Integrated Memory	RAM	8 MB SDRAM
	FLASH	4 MB serial Flash EPROM
	Size of the Dual-Port Memory	64 KByte
System Interface	Bus Type	PCI-104, according to [bus spec 7], refer to section <i>Overview</i> , page 132.
	Transmission Rate	33 MHz
	Data Access	DPM or DMA (Direct Memory Access)
	Width for the data access to the Dual-Port Memory (DPM)	32-Bit
Ethernet Communication	Supported Real-Time Ethernet communication systems (determined by the loaded firmware)	EtherCAT Master, EtherCAT Slave
		EtherNet/IP Scanner (Master), EtherNet/IP Adapter (Slave),
		Open Modbus/TCP
		POWERLINK Controlled Node/Slave
		PROFINET IO-Controller (Master), PROFINET IO-Device (Slave)
		sercos Master, sercos Slave
	VARAN Client (Slave)	
Ethernet Frame Types	Ethernet II	
Ethernet interface	Transmission Rate	100 MBit/s, 10 MBit/s (depending on loaded firmware)
	Interface Type	100 BASE-TX, 10 BASE-T (depending on loaded firmware), refer to section <i>Ethernet Interface</i> , page 123.
	Half duplex/Full duplex	depending on loaded firmware, supported (at 100 MBit/s)
	Auto-Negotiation	depending on loaded firmware
	Auto-Crossover	depending on loaded firmware
	Ethernet Assembly Interface	AIFX-RE, refer to section <i>AIFX-RE</i> , page 191. <b>Important!</b> Operating the PC card CIFX 104C-RE\F or CIFX 104C-RE-R\F requires proper connection of the Ethernet assembly interface (AIFX-RE) to the basic card!

CIFX 104C-RE\F, CIFX 104C-RE-R\F	Parameter	Value
	Connector AIFX-RE	Cable Connector Ethernet X304 (X4) (JST SM20B-SRSS-TB(LF)(SN), Pitch 1,0 mm)
	Channel 0 and 1	With loaded EtherCAT Master firmware only the RJ45 channel 0 can be used, channel 1 is deactivated. Beginning with the EtherCAT Master firmware version 3 channel 1 can be reactivated if redundancy is activated. For Open Modbus/TCP with V2.3.4.0 and higher both RJ45 channels can be used.
Diagnosis Interface	Diagnostic Assembly Interface	AIFX-DIAG, refer to section <i>AIFX-DIAG</i> , Page 196. <b>Note:</b> If the diagnostic <b>AIFX-DIAG</b> assembly interface is connected to the PC card CIFX 104C-RE\F or CIFX 104C-RE-R\F, the <b>Mini-B USB</b> connector on the AIFX-DIAG can be used beginning with the hardware revision 5 of the PC card cifX.
	Connector AIFX-DIAG	Cable Connector DIAG X303 (X3) (JST 12FMN-SMT-A-TF(LF)(SN), Pitch 1,0 mm)
Display	LED Display	<b>SYS</b> System Status LED
		For LEDs at AIFX-RE, refer to section <i>AIFX-RE</i> , page 191.
Power supply	Supply Voltage	+5 V dc $\pm 5\%$ or +3.3 V dc $\pm 5\%$ , refer to section <i>Power Supply and Host Interface</i> , page 46.
	Maximum Current at at 5 V (typically) ..... or at 3.3 V (typically).....	500 mA  730 mA
	Connector	Via PCI-104 Bus
Operation	Rotary Switch PCI-104 Slot Number	To set the PCI-104 Slot Number, refer to section <i>Rotary Switch for PCI-104 Slot Number</i> , page 127.
Environmental Conditions	Operating temperature range*	0 °C ... +70 °C
	*Air flow during measurement	0,5m/s
	Storage temperature range	0 °C ... +70 °C
	Humidity	10 ... 95% relative humidity, no condensation permitted
Device	Dimensions (L x W x H)	97 x 91 x 24 mm
	Mounting/Installation	PCI-104 Slot (Supply Voltage 5 V or 3.3 V, Signaling Voltage 5 V or 3.3 V), refer to section <i>Slot for the PC Cards cifX Compact PCI, Mini PCI, Mini PCIe, PCI-104</i> , page 43.
	RoHS	Yes
CE Sign	CE Sign	Yes
	Emission	EN 55011:2009 + A1:2010, CISPR 11:2009, Class A (Radio disturbance characteristics - Limits and methods of measurement)
	Immunity	EN 61000-4-2:2009 (Electrostatic discharge test) EN 61000-4-3:2006 + A1:2008 + A2:2010 (Radiated, radio-frequency, electromagnetic field test) EN 61000-4-4:2004 + A1:2010 (Burst Electrical fast transients/burst test) EN 61000-4-5:2006 (Surge test) EN 61000-4-6:2009 (to conducted disturbances, induced by radio- frequency fields) EN 61000-4-8:2010 (power frequency magnetic field test) EN 61000-6-2:2005 + B1:2011 (for industrial environments)

CIFX 104C-RE\F, CIFX 104C-RE-R\F	Parameter	Value
UL Certification	The device is certified according to UL 508	UL-File-Nr. E221530
Configuration	Configuration Software Master and Slave	SYCON.net
	Configuration Software Slave	netX Configuration Tool

Table 138: Technical Data CIFX 104C-RE\F, CIFX 104C-RE-R\F

### 10.1.23 CIFX 104C-DP, CIFX 104C-DP-R

CIFX 104C-DP, CIFX 104C-DP-R	Parameter	Value
Part	Name	CIFX 104C-DP                      CIFX 104C-DP-R
	Part No.	1270.410                              1271.410
	Description	PC Card cifX PCI-104 PROFIBUS DP Master or Slave and PROFIBUS MPI Device; (for CIFX 104C-DP-R connectors at the left side)
	Function	Communication Interface with PCI-104 and fieldbus interface PROFIBUS
Communication Controller	Type	netX 100 processor
Integrated Memory	RAM	8 MB SDRAM
	FLASH	4 MB serial Flash EPROM
	Size of the Dual-Port Memory	64 KByte
System Interface	Bus Type	PCI-104, according to [bus spec 7], refer to section <i>Overview</i> , page 132.
	Transmission Rate	33 MHz
	Data Access	DPM or DMA (Direct Memory Access)
	Width for the data access to the Dual-Port Memory (DPM)	32-Bit
PROFIBUS Communication	Supported communication standard/ protocol (determined by the loaded firmware)	PROFIBUS DP Master, PROFIBUS DP Slave, PROFIBUS MPI Device
PROFIBUS Interface	Transmission Rate	9,6 kBit/s, 19,2 kBit/s, 31,25 kBit/s, 45,45 kBit/s, 93,75 kBit/s, 187,5 kBit/s, 500 kBit/s, 1,5 MBit/s, 3 MBit/s, 6 MBit/s, 12 MBit/s
	Interface Type	RS 485, refer to section <i>PROFIBUS Interface</i> , page 125.
	Galvanic Isolation	isolated
	Isolation Voltage	1000 VDC (tested for 1 minute)
	Connector	DSub female Connector, 9 pin
Diagnosis Interface	USB Interface	Mini B USB Plug (5 pin), refer to section <i>Mini-B USB Connector (5 Pin)</i> , page 127.
Display	LED Display	<b>SYS</b> System Status LED <b>COM 0</b> LED Communication Status 0 (duo LED) The meaning of the COM LED depends on the loaded firmware. Refer to chapter <i>LED Descriptions</i> , page 94.
Power supply	Supply Voltage	+5 V dc ±5 % or +3.3 V dc ±5 %, refer to section <i>Power Supply and Host Interface</i> , page 46.
	Maximum Current at at 5 V (typically) ..... or at 3.3 V (typically).....	500 mA 650 mA
	Connector	Via PCI-104 Bus

CIFX 104C-DP, CIFX 104C-DP-R	Parameter	Value
Operation	Rotary Switch PCI-104 Slot Number	To set the PCI-104 Slot Number, refer to section <i>Rotary Switch for PCI-104 Slot Number</i> , page 127.
	Rotary Switch Device Address	Is currently unassigned. Refer to section <i>Rotary Switch Device Address</i> on page 127.
Environmental Conditions	Operating temperature range*	-20 °C ... +70 °C (acc. to UL: 0 °C ... +55 °C)
	*Air flow during measurement	0,5m/s
	Storage temperature range	0 °C ... +70 °C
	Humidity	10 ... 95% relative humidity, no condensation permitted
	Environment	For UL compliant usage: The device must be used in a pollution degree 2 environment.
Device	Dimensions (L x W x H)	97 x 91 x 24 mm
	Mounting/Installation	PCI-104 Slot (Supply Voltage 5 V or 3.3 V, Signaling Voltage 5 V or 3.3 V), refer to section <i>Slot for the PC Cards cifX Compact PCI, Mini PCI, Mini PCIe, PCI-104</i> , page 43
	RoHS	Yes
CE Sign	CE Sign	Yes
	Emission	EN 55011:2009 + A1:2010, CISPR 11:2009, Class A (Radio disturbance characteristics - Limits and methods of measurement)
	Immunity	EN 61000-4-2:2009 (Electrostatic discharge test) EN 61000-4-3:2006 + A1:2008 + A2:2010 (Radiated, radio-frequency, electromagnetic field test) EN 61000-4-4:2004 + A1:2010 (Burst Electrical fast transients/burst test) EN 61000-4-5:2006 (Surge test) EN 61000-4-6:2009 (to conducted disturbances, induced by radio- frequency fields) EN 61000-4-8:2010 (power frequency magnetic field test) EN 61000-6-2:2005 + B1:2011 (for industrial environments)
UL Certification	The device is certified according to UL 508	UL-File-Nr. E221530
Configuration	Configuration Software Master and Slave	SYCON.net
	Configuration Software Slave	netX Configuration Tool

Table 139: Technical Data CIFX 104C-DP, CIFX 104C-DP-R

### 10.1.24 CIFX 104C-DP\F, CIFX 104C-DP-R\F

CIFX 104C-DP\F, CIFX 104C-DP-R\F	Parameter	Wert	
Part	Name	CIFX 104C-DP\F	CIFX 104C-DP-R\F
	Part No.	1270.411	1271.411
	Description	PC Card cifX PCI-104 PROFIBUS DP Master or Slave and PROFIBUS MPI Device composed of: - Basic card CIFX 104C-FB\F or CIFX 104C-FB-R\F* with cable connector Fieldbus X304 (X4) and cable connector DIAG X303 (X3) (*connectors at the left side) - PROFIBUS assembly interface (AIFX-DP) and - diagnostic assembly interface (AIFX-DIAG).	
	Function	Communication Interface with PCI-104 and fieldbus interface PROFIBUS	

CIFX 104C-DP\F, CIFX 104C-DP-R\F	Parameter	Wert
Communication Controller	Type	netX 100 processor
Integrated Memory	RAM	8 MB SDRAM
	FLASH	4 MB serial Flash EPROM
	Size of the Dual-Port Memory	64 KByte
System Interface	Bus Type	PCI-104, according to [bus spec 7], refer to section <i>Overview</i> , page 132.
	Transmission Rate	33 MHz
	Data Access	DPM or DMA (Direct Memory Access)
	Width for the data access to the Dual-Port Memory (DPM)	32-Bit
PROFIBUS Communication	Supported communication standard/ protocol (determined by the loaded firmware)	PROFIBUS DP Master, PROFIBUS DP Slave, PROFIBUS MPI Device
PROFIBUS Interface	Transmission Rate	9,6 kBit/s, 19,2 kBit/s, 31,25 kBit/s, 45,45 kBit/s, 93,75 kBit/s, 187,5 kBit/s, 500 kBit/s, 1,5 MBit/s, 3 MBit/s, 6 MBit/s, 12 MBit/s
	Interface Type	RS 485, refer to section <i>PROFIBUS Interface</i> page 125.
	PROFIBUS Assembly Interface	AIFX-DP, refer to section <i>AIFX-DP</i> page 192. <b>Important!</b> Operating the PC card CIFX 104C-DP\F or CIFX 104C-DP-R\F requires proper connection of the PROFIBUS assembly interface (AIFX-DP) to the basic card!
	Connector AIFX-DP	Cable Connector Fieldbus X304 (X4) (JST 10FMN-SMT-A-TF(LF)(SN), Pitch 1,0 mm)
Diagnosis Interface	Diagnostic Assembly Interface	AIFX-DIAG, refer to section <i>AIFX-DIAG</i> , Page 196.
	Connector AIFX-DIAG	Cable Connector DIAG X303 (X3) (JST 12FMN-SMT-A-TF(LF)(SN), Pitch 1,0 mm)
Display	LED Display	<b>SYS</b> System Status LED
		For LEDs at AIFX-DP, refer to section <i>AIFX-DP</i> page 192.
Power supply	Supply Voltage	+5 V dc $\pm 5\%$ or +3.3 V dc $\pm 5\%$ , refer to section <i>Power Supply and Host Interface</i> , page 46.
	Maximum Current at at 5 V (typically) ..... or at 3.3 V (typically).....	500 mA 650 mA
	Connector	Via PCI-104 Bus
Operation	Rotary Switch PCI-104 Slot Number	To set the PCI-104 Slot Number, refer to section <i>Rotary Switch for PCI-104 Slot Number</i> , page 127.
Environmental Conditions	Operating temperature range*	-20 °C ... +70 °C (acc. to UL: 0 °C ... +55 °C)
	*Air flow during measurement	0,5m/s
	Storage temperature range	-10 °C ... +70 °C
	Humidity	10 ... 95% relative humidity, no condensation permitted
	Environment	For UL compliant usage: The device must be used in a pollution degree 2 environment.
Device	Dimensions (L x W x H)	97 x 91 x 24 mm
	Mounting/Installation	PCI-104 Slot (Supply Voltage 5 V or 3.3 V, Signaling Voltage 5 V or 3.3 V), refer to section <i>Slot for the PC Cards cifX Compact PCI, Mini PCI, Mini PCIe, PCI-104</i> , page 43.
	RoHS	Yes
CE Sign	CE Sign	Yes

CIFX 104C-DP\F, CIFX 104C-DP-R\F	Parameter	Wert
	Emission	EN 55011:2009 + A1:2010, CISPR 11:2009, Class A (Radio disturbance characteristics - Limits and methods of measurement)
	Immunity	EN 61000-4-2:2009 (Electrostatic discharge test) EN 61000-4-3:2006 + A1:2008 + A2:2010 (Radiated, radio-frequency, electromagnetic field test) EN 61000-4-4:2004 + A1:2010 (Burst Electrical fast transients/burst test) EN 61000-4-5:2006 (Surge test) EN 61000-4-6:2009 (to conducted disturbances, induced by radio- frequency fields) EN 61000-4-8:2010 (power frequency magnetic field test) EN 61000-6-2:2005 + B1:2011 (for industrial environments)
UL Certification	The device is certified according to UL 508	UL-File-Nr. E221530
Configuration	Configuration Software Master and Slave	SYCON.net
	Configuration Software Slave	netX Configuration Tool

Table 140: Technical Data CIFX 104C-DP\F, CIFX 104C-DP-R\F

### 10.1.25 CIFX 104C-CO, CIFX 104C-CO-R

CIFX 104C-CO, CIFX 104C-CO-R	Parameter	Value	
Part	Name	CIFX 104C-CO	CIFX 104C-CO-R
	Part No.	1270.500	1271.500
	Description	PC Card cifX PCI-104 CANopen Master or Slave; (for CIFX 104C-CO-R connectors at the left side)	
	Function	Communication Interface with PCI-104 and fieldbus interface CANopen	
Communication Controller	Type	netX 100 processor	
Integrated Memory	RAM	8 MB SDRAM	
	FLASH	4 MB serial Flash EPROM	
	Size of the Dual-Port Memory	64 KByte	
System Interface	Bus Type	PCI-104, according to [bus spec 7], refer to section Overview, page 132.	
	Transmission Rate	33 MHz	
	Data Access	DPM or DMA (Direct Memory Access)	
	Width for the data access to the Dual-Port Memory (DPM)	32-Bit	
CANopen Communication	Supported communication standard/ protocol (determined by the loaded firmware)	CANopen Master, CANopen Slave	
CANopen Interface	Transmission Rate	10 kBit/s, 20 kBit/s, 50 kBit/s, 100 kBit/s, 125 kBit/s, 250 kBit/s, 500 kBit/s, 800 kBit/s, 1 MBit/s	
	Interface Type	ISO-11898, refer to section CANopen Interface, page 125.	
	Galvanic Isolation	isolated (optically isolated)	
	Isolation Voltage	1000 VDC (tested for 1 minute)	
	Connector	DSub male Connector, 9 pin	

CIFX 104C-CO, CIFX 104C-CO-R	Parameter	Value
Diagnosis Interface	USB Interface	Mini B USB Plug (5 pin), refer to section <i>Mini-B USB Connector (5 Pin)</i> , page 127.
Display	LED Display	<b>SYS</b> System Status LED <b>CAN</b> CANopen Status (duo LED) The meaning of the CAN LED is depending on loaded firmware. Refer to chapter <i>LED Descriptions</i> , page 94.
Power supply	Supply Voltage	+5 V dc $\pm 5\%$ or +3.3 V dc $\pm 5\%$ , refer to section <i>Power Supply and Host Interface</i> , page 46.
	Maximum Current at at 5 V (typically) ..... or at 3.3 V (typically).....	500 mA  650 mA
	Connector	Via PCI-104 Bus
Operation	Rotary Switch PCI-104 Slot Number	To set the PCI-104 Slot Number, refer to section <i>Rotary Switch for PCI-104 Slot Number</i> , page 127.
	Rotary Switch Device Address	Is currently unassigned. Refer to section <i>Rotary Switch Device Address</i> on page 127.
Environmental Conditions	Operating temperature range*	-20 °C ... +70 °C ( <i>acc. to UL: 0 °C ... +55 °C</i> )
	*Air flow during measurment	0,5m/s
	Storage temperature range	-10 °C ... +70 °C
	Humidity	10 ... 95% relative humidity, no condensation permitted
	Environment	For UL compliant usage: The device must be used in a pollution degree 2 environment.
Device	Dimensions (L x W x H)	97 x 91 x 24 mm
	Mounting/Installation	PCI-104 Slot (Supply Voltage 5 V or 3.3 V, Signaling Voltage 5 V or 3.3 V), refer to section <i>Slot for the PC Cards cifX Compact PCI, Mini PCI, Mini PCIe, PCI-104</i> , page 43.
	RoHS	Yes
CE Sign	CE Sign	Yes
	Emission	EN 55011:2009 + A1:2010, CISPR 11:2009, Class A (Radio disturbance characteristics - Limits and methods of measurement)
	Immunity	EN 61000-4-2:2009 (Electrostatic discharge test) EN 61000-4-3:2006 + A1:2008 + A2:2010 (Radiated, radio-frequency, electromagnetic field test) EN 61000-4-4:2004 + A1:2010 (Burst Electrical fast transients/burst test) EN 61000-4-5:2006 (Surge test) EN 61000-4-6:2009 (to conducted disturbances, induced by radio- frequency fields) EN 61000-4-8:2010 (power frequency magnetic field test) EN 61000-6-2:2005 + B1:2011 (for industrial environments)
UL Certification	The device is certified according to UL 508	UL-File-Nr. E221530
Configuration	Configuration Software Master and Slave	SYCON.net
	Configuration Software Slave	netX Configuration Tool

Table 141: Technical Data CIFX 104C-CO, CIFX 104C-CO-R

### 10.1.26 CIFX 104C-CO\F, CIFX 104C-CO-R\F

CIFX 104C-CO\F, CIFX 104C-CO-R\F	Parameter	Value	
Part	Name	CIFX 104C-CO\F	CIFX 104C-CO-R\F
	Part No.	1270.501	1271.501
	Description	PC Card cifX PCI-104 CANopen Master or Slave composed of: - Basic card CIFX 104C-FB\F or CIFX 104C-FB-R\F* with cable connector Fieldbus X304 (X4) and cable connector DIAG X303 (X3) (*connectors at the left side) - CANopen assembly interface (AIFX-CO) and - diagnostic assembly interface (AIFX-DIAG).	
	Function	Communication Interface with PCI-104 and fieldbus interface CANopen	
Communication Controller	Type	netX 100 processor	
Integrated Memory	RAM	8 MB SDRAM	
	FLASH	4 MB serial Flash EPROM	
	Size of the Dual-Port Memory	64 KByte	
System Interface	Bus Type	PCI-104, according to [bus spec 7], refer to section <i>Overview</i> , page 132.	
	Transmission Rate	33 MHz	
	Data Access	DPM or DMA (Direct Memory Access)	
	Width for the data access to the Dual-Port Memory (DPM)	32-Bit	
CANopen Communication	Supported communication standard/ protocol (determined by the loaded firmware)	CANopen Master, CANopen Slave	
CANopen Interface	Transmission Rate	10 kBit/s, 20 kBit/s, 50 kBit/s, 100 kBit/s, 125 kBit/s, 250 kBit/s, 500 kBit/s, 800 kBit/s, 1 MBit/s	
	Interface Type	ISO-11898, refer to section <i>CANopen Interface</i> , page 125.	
	CANopen Assembly Interface	AIFX-CO, refer to section <i>AIFX-CO</i> , page 193. <b>Important!</b> Operating the PC card CIFX 104C-CO\F or CIFX 104C-CO-R\F requires proper connection of the CANopen assembly interface (AIFX-CO) to the basic card!	
	Connector AIFX-CO	Cable Connector Fieldbus X304 (X4) (JST 10FMN-SMT-A-TF(LF)(SN), Pitch 1,0 mm)	
Diagnosis Interface	Diagnostic Assembly Interface	AIFX-DIAG, refer to section <i>AIFX-DIAG</i> , Page 196.	
	Connector AIFX-DIAG	Cable Connector DIAG X303 (X3) (JST 12FMN-SMT-A-TF(LF)(SN), Pitch 1,0 mm)	
Display	LED Display	<b>SYS</b> System Status LED	
		For LEDs at AIFX-CO, refer to section <i>AIFX-CO</i> , p. 193.	
Power supply	Supply Voltage	+5 V dc $\pm 5\%$ or +3.3 V dc $\pm 5\%$ , refer to section <i>Power Supply and Host Interface</i> , page 46.	
	Maximum Current at at 5 V (typically) ..... or at 3.3 V (typically).....	500 mA 650 mA	
	Connector	Via PCI-104 Bus	
Operation	Rotary Switch PCI-104 Slot Number	To set the PCI-104 Slot Number, refer to section <i>Rotary Switch for PCI-104 Slot Number</i> , page 127.	
Environmental Conditions	Operating temperature range*	-20 °C ... +70 °C (acc. to UL: 0 °C ... +55 °C)	
	*Air flow during measurement	0,5m/s	



CIFX 104C-CO\F, CIFX 104C-CO-R\F	Parameter	Value
	Storage temperature range	-10 °C ... +70 °C
	Humidity	10 ... 95% relative humidity, no condensation permitted
	Environment	For UL compliant usage: The device must be used in a pollution degree 2 environment.
Device	Dimensions (L x W x H)	97 x 91 x 24 mm
	Mounting/Installation	PCI-104 Slot (Supply Voltage 5 V or 3.3 V, Signaling Voltage 5 V or 3.3 V), refer to section <i>Slot for the PC Cards cifX Compact PCI, Mini PCI, Mini PCIe, PCI-104</i> , page 43.
	RoHS	Yes
CE Sign	CE Sign	Yes
	Emission	EN 55011:2009 + A1:2010, CISPR 11:2009, Class A (Radio disturbance characteristics - Limits and methods of measurement)
	Immunity	EN 61000-4-2:2009 (Electrostatic discharge test) EN 61000-4-3:2006 + A1:2008 + A2:2010 (Radiated, radio-frequency, electromagnetic field test) EN 61000-4-4:2004 + A1:2010 (Burst Electrical fast transients/burst test) EN 61000-4-5:2006 (Surge test) EN 61000-4-6:2009 (to conducted disturbances, induced by radio- frequency fields) EN 61000-4-8:2010 (power frequency magnetic field test) EN 61000-6-2:2005 + B1:2011 (for industrial environments)
UL Certification	The device is certified according to UL 508	UL-File-Nr. E221530
Configuration	Configuration Software Master and Slave	SYCON.net
	Configuration Software Slave	netX Configuration Tool

Table 142: Technical Data CIFX 104C-CO\F, CIFX 104C-CO-R\F

### 10.1.27 CIFX 104C-DN, CIFX 104C-DN-R

CIFX 104C-DN, CIFX 104C-DN-R	Parameter	Value
Part	Name	CIFX 104C-DN      CIFX 104C-DN-R
	Part No.	1270.510      1271.510
	Description	PC Card cifX PCI-104 DeviceNet Master or Slave; (for CIFX 104C-DN-R connectors at the left side)
	Function	Communication Interface with PCI-104 and fieldbus interface DeviceNet
Communication Controller	Type	netX 100 processor
Integrated Memory	RAM	8 MB SDRAM
	FLASH	4 MB serial Flash EPROM
	Size of the Dual-Port Memory	64 KByte
System Interface	Bus Type	PCI-104, according to [bus spec 7], refer to section <i>Overview</i> , page 132.
	Transmission Rate	33 MHz
	Data Access	DPM or DMA (Direct Memory Access)

CIFX 104C-DN, CIFX 104C-DN-R	Parameter	Value
	Width for the data access to the Dual-Port Memory (DPM)	32-Bit
DeviceNet Communication	Supported communication standard/ protocol (determined by the loaded firmware)	DeviceNet Master, DeviceNet Slave
DeviceNet Interface	Transmission Rate	125 kBit/s, 250 kBit/s, 500 kBit/s
	Interface Type	ISO-11898 according to DeviceNet specification, refer to section <i>DeviceNet Interface</i> , page 126.
	Galvanic Isolation	isolated (optically isolated)
	Isolation Voltage	1000 VDC (tested for 1 minute)
	Connector	CombiCon male Connector, 5-polig
Diagnosis Interface	USB Interface	Mini B USB Plug (5 pin), refer to section <i>Mini-B USB Connector (5 Pin)</i> , page 127.
Display	LED Display	<b>SYS</b> System Status LED <b>MNS</b> Module network status (duo LED) The meaning of the MNS LED is depending on loaded firmware. Refer to chapter <i>LED Descriptions</i> , page 94..
Power supply	Supply Voltage	+5 V dc $\pm 5\%$ or +3.3 V dc $\pm 5\%$ , refer to section <i>Power Supply and Host Interface</i> , page 46.
	Maximum Current at at 5 V (typically) ..... or at 3.3 V (typically).....	500 mA  650 mA
	Connector	Via PCI-104 Bus
Operation	Rotary Switch PCI-104 Slot Number	To set the PCI-104 Slot Number, refer to section <i>Rotary Switch for PCI-104 Slot Number</i> , page 127.
	Rotary Switch Device Address	Is currently unassigned. Refer to section <i>Rotary Switch Device Address</i> on page 127.
Environmental Conditions	Operating temperature range*	-20 °C ... +70 °C (acc. to UL: 0 °C ... +55 °C)
	*Air flow during measurment	0,5m/s
	Storage temperature range	-10 °C ... +70 °C
	Humidity	10 ... 95% relative humidity, no condensation permitted
	Environment	For UL compliant usage: The device must be used in a pollution degree 2 environment.
Device	Dimensions (L x W x H)	97 x 91 x 24 mm
	Mounting/Installation	PCI-104 Slot (Supply Voltage 5 V or 3.3 V, Signaling Voltage 5 V or 3.3 V), refer to section <i>Slot for the PC Cards cifX Compact PCI, Mini PCI, Mini PCIe, PCI-104</i> , page 43.
	RoHS	Yes
CE Sign	CE Sign	Yes
	Emission	EN 55011:2009 + A1:2010, CISPR 11:2009, Class A (Radio disturbance characteristics - Limits and methods of measurement)
	Immunity	EN 61000-4-2:2009 (Electrostatic discharge test) EN 61000-4-3:2006 + A1:2008 + A2:2010 (Radiated, radio-frequency, electromagnetic field test) EN 61000-4-4:2004 + A1:2010 (Burst Electrical fast transients/burst test) EN 61000-4-5:2006 (Surge test) EN 61000-4-6:2009 (to conducted disturbances, induced by radio- frequency fields)

CIFX 104C-DN, CIFX 104C-DN-R	Parameter	Value
		EN 61000-4-8:2010 (power frequency magnetic field test) EN 61000-6-2:2005 + B1:2011 (for industrial environments)
UL Certification	The device is certified according to UL 508	UL-File-Nr. E221530
Configuration	Configuration Software Master and Slave	SYCON.net
	Configuration Software Slave	netX Configuration Tool

Table 143: Technical Data CIFX 104C-DN, CIFX 104C-DN-R

### 10.1.28 CIFX 104C-DN\F, CIFX 104C-DN-R\F

CIFX 104C-DN\F, CIFX 104C-DN-R\F	Parameter	Value
Part	Name	CIFX 104C-DN\F      CIFX 104C-DN-R\F
	Part No.	1270.511      1271.511
	Description	PC Card cifX PCI-104 DeviceNet Master or Slave composed of: - Basic card CIFX 104C-FB\F or CIFX 104C-FB-R\F* with cable connector Fieldbus X304 (X4) and cable connector DIAG X303 (X3) (*connectors at the left side) - DeviceNet assembly interface (AIFX-DN) and - diagnostic assembly interface (AIFX-DIAG).
	Function	Communication Interface with PCI-104 and fieldbus interface DeviceNet
Communication Controller	Type	netX 100 processor
Integrated Memory	RAM	8 MB SDRAM
	FLASH	4 MB serial Flash EPROM
	Size of the Dual-Port Memory	64 KByte
System Interface	Bus Type	PCI-104, according to [bus spec 7], refer to section <i>Overview</i> , page 132.
	Transmission Rate	33 MHz
	Data Access	DPM or DMA (Direct Memory Access)
	Width for the data access to the Dual-Port Memory (DPM)	32-Bit
DeviceNet Communication	Supported communication standard/ protocol (determined by the loaded firmware)	DeviceNet Master, DeviceNet Slave
DeviceNet Interface	Transmission Rate	125 kBit/s, 250 kBit/s, 500 kBit/s
	Interface Type	ISO-11898 according to DeviceNet specification, refer to section <i>DeviceNet Interface</i> , page 126.
	DeviceNet Assembly Interface	AIFX-DN, refer to section <i>AIFX-DN</i> , page 194. <b>Important!</b> Operating the PC card CIFX 104C-DN\F or CIFX 104C-DN-R\F requires proper connection of the DeviceNet assembly interface (AIFX-DN) to the basic card!
	Connector AIFX-DN	Cable Connector Fieldbus X304 (X4) (JST 10FMN-SMT-A-TF(LF)(SN), Pitch 1,0 mm)
Diagnosis Interface	Diagnostic Assembly Interface	AIFX-DIAG, refer to section <i>AIFX-DIAG</i> , Page 196.
	Connector AIFX-DIAG	Cable Connector DIAG X303 (X3) (JST 12FMN-SMT-A-TF(LF)(SN), Pitch 1,0 mm)
Display	LED Display	<b>SYS</b> System Status LED
		For LED at AIFX-DN, refer to section <i>AIFX-DN</i> , p. 194.

CIFX 104C-DN\F, CIFX 104C-DN-R\F	Parameter	Value
Power supply	Supply Voltage	+5 V dc $\pm 5\%$ or +3.3 V dc $\pm 5\%$ , refer to section <i>Power Supply and Host Interface</i> , page 46.
	Maximum Current at at 5 V (typically) ..... or at 3.3 V (typically).....	500 mA  650 mA
	Connector	Via PCI-104 Bus
Operation	Rotary Switch PCI-104 Slot Number	To set the PCI-104 Slot Number, refer to section <i>Rotary Switch for PCI-104 Slot Number</i> , page 127.
Environmental Conditions	Operating temperature range*	-20 °C ... +70 °C (acc. to UL: 0 °C ... +55 °C)
	*Air flow during measurment	0,5m/s
	Storage temperature range	-10 °C ... +70 °C
	Humidity	10 ... 95% relative humidity, no condensation permitted
	Environment	For UL compliant usage: The device must be used in a pollution degree 2 environment.
Device	Dimensions (L x W x H)	97 x 91 x 24 mm
	Mounting/Installation	PCI-104 Slot (Supply Voltage 5 V or 3.3 V, Signaling Voltage 5 V or 3.3 V), refer to section <i>Slot for the PC Cards cifX Compact PCI, Mini PCI, Mini PCIe, PCI-104</i> , page 43.
	RoHS	Yes
CE Sign	CE Sign	Yes
	Emission	EN 55011:2009 + A1:2010, CISPR 11:2009, Class A (Radio disturbance characteristics - Limits and methods of measurement)
	Immunity	EN 61000-4-2:2009 (Electrostatic discharge test) EN 61000-4-3:2006 + A1:2008 + A2:2010 (Radiated, radio-frequency, electromagnetic field test) EN 61000-4-4:2004 + A1:2010 (Burst Electrical fast transients/burst test) EN 61000-4-5:2006 (Surge test) EN 61000-4-6:2009 (to conducted disturbances, induced by radio- frequency fields) EN 61000-4-8:2010 (power frequency magnetic field test) EN 61000-6-2:2005 + B1:2011 (for industrial environments)
UL Certification	The device is certified according to UL 508	UL-File-Nr. E221530
Configuration	Configuration Software Master and Slave	SYCON.net
	Configuration Software Slave	netX Configuration Tool

Table 144: Technical Data CIFX104C-DN\F, CIFX 104C-DN-R\F

### 10.1.29 CIFX 104C-CC\F

CIFX 104C-CC\F	Parameter	Value
Part	Name	CIFX 104C-CC\F
	Part No.	1270.741
	Description	PC Card cifX PCI-104 CC-Link Slave composed of: - Basic card CIFX 104C-FB\F with cable connector Fieldbus X304 and cable connector DIAG X303, - CC-Link assembly interface (AIFX-CC) and - diagnostic assembly interface (AIFX-DIAG).
	Function	Communication Interface with PCI-104 and fieldbus interface CC-Link
Communication Controller	Type	netX 100 processor
Integrated Memory	RAM	8 MB SDRAM
	FLASH	4 MB serial Flash EPROM
	Size of the Dual-Port Memory	64 KByte
System Interface	Bus Type	PCI-104, according to [bus spec 7], refer to section <i>Overview</i> , page 132.
	Transmission Rate	33 MHz
	Data Access	DPM or DMA (Direct Memory Access)
	Width for the data access to the Dual-Port Memory (DPM)	32-Bit
CC-Link Communication	Supported communication standard/ protocol (determined by the loaded firmware)	CC-Link Slave
CC-Link Interface	Transmission Rate	156 kBit/s, 625 kBit/s, 2500 kBit/s, 5 MBit/s, 10 MBit/s
	Interface Type	RS-485, refer to section <i>CC-Link Interface</i> , page 126.
	CC-Link Assembly Interface	AIFX-CC, refer to section <i>AIFX-CC</i> , page 195. <b>Important!</b> Operating the PC card CIFX 104C-CC\F requires proper connection of the CC-Link assembly interface (AIFX-CC) to the basic card!
	Connector AIFX-CC	Cable Connector Fieldbus X304 (JST 10FMN-SMT-A-TF(LF)(SN), Pitch 1,0 mm)
Diagnosis Interface	Diagnostic Assembly Interface	AIFX-DIAG, refer to section <i>AIFX-DIAG</i> , Page 196.
	Connector AIFX-DIAG	Cable Connector DIAG X303 (JST 12FMN-SMT-A-TF(LF)(SN), Pitch 1,0 mm)
Display	LED Display	<b>SYS</b> System Status LED
		For LEDs at AIFX-CC, refer to section <i>AIFX-CC</i> , p. 195.
Power supply	Supply Voltage	+5 V dc $\pm 5\%$ or +3.3 V dc $\pm 5\%$ , refer to section <i>Power Supply and Host Interface</i> , page 46.
	Maximum Current at at 5 V (typically) ..... or at 3.3 V (typically).....	500 mA 650 mA
	Connector	Via PCI-104 Bus
Operation	Rotary Switch PCI-104 Slot Number	To set the PCI-104 Slot Number, refer to section <i>Rotary Switch for PCI-104 Slot Number</i> , page 127.
Environmental Conditions	Operating temperature range*	0 °C ... +60 °C
	*Air flow during measurement	0,5m/s
	Storage temperature range	-10 °C ... +70 °C
	Humidity	10 ... 95% relative humidity, no condensation permitted
Device	Dimensions (L x W x H)	97 x 91 x 24 mm

CIFX 104C-CC\F	Parameter	Value
	Mounting/Installation	PCI-104 Slot (Supply Voltage 5 V or 3.3 V, Signaling Voltage 5 V or 3.3 V), refer to section <i>Slot for the PC Cards cifX Compact PCI, Mini PCI, Mini PCIe, PCI-104</i> , page 43.
	RoHS	Yes
CE Sign	CE Sign	Yes
	Emission	EN 55011:2009 + A1:2010, CISPR 11:2009, Class A (Radio disturbance characteristics - Limits and methods of measurement)
	Immunity	EN 61000-4-2:2009 (Electrostatic discharge test) EN 61000-4-3:2006 + A1:2008 + A2:2010 (Radiated, radio-frequency, electromagnetic field test) EN 61000-4-4:2004 + A1:2010 (Burst Electrical fast transients/burst test) EN 61000-4-5:2006 (Surge test) EN 61000-4-6:2009 (to conducted disturbances, induced by radio- frequency fields) EN 61000-4-8:2010 (power frequency magnetic field test) EN 61000-6-2:2005 + B1:2011 (for industrial environments)
Configuration	Configuration Software	SYCON.net or netX Configuration Tool

Table 145: Technical Data CIFX104C-CC\F

### 10.1.30 AIFX-RE

AIFX-RE	Parameter	Value
Part	Name	AIFX-RE
	Part No.	2800.100
	Description	Ethernet Assembly Interface (with Ethernet interface) for the PC cards CIFX 90-RE\F, CIFX 90E-RE\F, CIFX 90E-RE\ET\F, CIFX 90E-RE\MR\F, CIFX 90E-RE\MR\ET\F, CIFX 104C-RE\F, CIFX 104C-RE-R\F
Interface PC Card cifX	Connector	Cable Connector Ethernet X1 (JST SM20B-SRSS-TB(LF)(SN), Pitch 1.0 mm)
Ethernet Interface	Galvanic Isolation	isolated
	Isolation Voltage	1000 VDC (tested for 1 minute)
	Connector	2* RJ45 Socket
Display	LED Display (on the reverse side of the device)	The meaning of the following LEDs depends on the loaded firmware::  <b>COM 0</b> LED Communication Status 0 (duo LED) <b>COM 1</b> LED Communication Status 1 (duo LED) <b>LED yellow</b> at RJ45Ch0 and RJ45Ch1, <b>LED green</b> for Ethernet Link status, Ethernet Activity status and additional status  Refer to chapter <i>LED Descriptions</i> , page 94.
Power supply	Connector	Cable Connector Ethernet X1
Environmental Conditions	Operating temperature range*	0 °C ... +70 °C
	*Air flow during measurment	0,5m/s
	Storage temperature range	0 °C ... +70 °C
	Humidity	10 ... 95% relative humidity, no condensation permitted
	Environment	For UL compliant usage: The device must be used in a pollution degree 2 environment.
Device	Dimensions (L x W x H)	30,7 x 42,3 x 18,5 mm (H = width of the front panel)
	Mounting/Installation	At the basic cards CIFX 90, CIFX 90E, CIFX 90E\ET, CIFX 90E\MR, CIFX 90E\MR\ET: Cable Connector Ethernet X4; or at CIFX 104C-RE\F, CIFX 104C-RE-R\F: Cable Connector Ethernet X304 (X4)
	RoHS	Yes
CE Sign	CE Sign	Yes
	Emission, Immunity	Tested together with the corresponding basic cards cifX.
UL Certification	The device is certified according to UL 508	UL-File-Nr. E221530

Table 146: Technical Data AIFX-RE

### 10.1.31 AIFX-DP

AIFX-DP	Parameter	Value
Part	Name	AIFX-DP
	Part No.	2800.400
	Description	PROFIBUS assembly interface (with PROFIBUS interface) for the PC cards CIFX 90-DP\F, CIFX 90E-DP\F, CIFX 90E-DP\ET\F, CIFX 90E-DP\MR\F, CIFX 90E-DP\MR\ET\F, CIFX 90E-2DP\ET\F, CIFX 90E-2DP\MR\ET\F, CIFX 90E-2DP\CO\ET\F, CIFX 90E-2DP\CO\MR\ET\F, CIFX 90E-2DP\DN\ET\F, CIFX 90E-2DP\DN\MR\ET\F, CIFX 104C-DP\F, CIFX 104C-DP-R\F
Interface PC Card cifX	Connector	Cable Connector Fieldbus X1 (JST 10FMN-SMT-A-TF(LF)(SN), Pitch 1,0 mm)
PROFIBUS Interface	Galvanic Isolation	isolated
	Isolation Voltage	1000 VDC (tested for 1 minute)
	Connector	DSub female Connector, 9 pin
Display	LED Display (on the reverse side of the device)	The meaning of the following LEDs depends on the loaded firmware: <b>ERR</b> LED Error status (red) <b>STA</b> LED Status (green) For PROFIBUS MPI the STA LED is not used. Refer to chapter <i>LED Descriptions</i> , page 94.
Power supply	Connector	Cable Connector Fieldbus X1
Environmental Conditions	Operating temperature range*	-20 °C ... +70 °C
	*Air flow during measurement	0,5m/s
	Storage temperature range	-10 °C ... +70 °C
	Humidity	10 ... 95% relative humidity, no condensation permitted
	Environment	For UL compliant usage: The device must be used in a pollution degree 2 environment.
Device	Dimensions (L x W x H)	17 x 31 x 18,5 mm (H = width of the front panel)
	Mounting/Installation	At the basic cards CIFX 90, CIFX 90E, CIFX 90E\ET, CIFX 90E\MR, CIFX 90E\MR\ET: Cable Connector Fieldbus X3; or at CIFX 104C-FB\F, CIFX 104C-FB-R\F: Cable Connector Fieldbus X304 (X4)
	RoHS	Yes
CE Sign	CE Sign	Yes
	Emission, Immunity	Tested together with the corresponding basic cards cifX.
UL Certification	The device is certified according to UL 508	UL-File-Nr. E221530

Table 147: Technical Data AIFX-DP



### 10.1.32 AIFX-CO

AIFX-CO	Parameter	Value
Part	Name	AIFX-CO
	Part No.	2800.500
	Description	CANopen assembly interface (with CANopen interface) for the PC cards CIFX 90-CO\F, CIFX 90E-CO\F, CIFX 90E-CO\ET\F, CIFX 90E-CO\MR\F, CIFX 90E-CO\MR\ET\F, CIFX 90E-2DP\CO\ET\F, CIFX 90E-2DP\CO\MR\ET\F, CIFX 90E-2CO\ET\F, CIFX 90E-2CO\MR\ET\F, CIFX 90E-2CO\DN\ET\F, CIFX 90E-2CO\DN\MR\ET\F, CIFX 104C-CO\F, CIFX 104C-CO-R\F
Interface PC Card cifX	Connector	Cable Connector Fieldbus X1 (JST 10FMN-SMT-A-TF(LF)(SN), Pitch 1,0 mm)
CANopen Interface	Galvanic Isolation	isolated (optically isolated)
	Isolation Voltage	1000 VDC (tested for 1 minute)
	Connector	DSub male Connector, 9 pin
Display	LED Display (on the reverse side of the device)	The meaning of the following LEDs depends on the loaded firmware:: <b>ERR</b> LED Error status (red) <b>RUN</b> LED Run (green) Refer to chapter <i>LED Descriptions</i> , page 94.
Power supply	Connector	Cable Connector Fieldbus X1
Environmental Conditions	Operating temperature range*	-20 °C ... +70 °C
	*Air flow during measurement	0,5m/s
	Storage temperature range	-10 °C ... +70 °C
	Humidity	10 ... 95% relative humidity, no condensation permitted
	Environment	For UL compliant usage: The device must be used in a pollution degree 2 environment.
Device	Dimensions (L x W x H)	17 x 31 x 18,5 mm (H = width of the front panel)
	Mounting/Installation	At the basic cards CIFX 90, CIFX 90E, CIFX 90E\ET, CIFX 90E\MR, CIFX 90E\MR\ET: Cable Connector Fieldbus X3; or at CIFX 104C-FB\F, CIFX 104C-FB-R\F: Cable Connector Fieldbus X304 (X4)
	RoHS	Yes
CE Sign	CE Sign	Yes
	Emission, Immunity	Tested together with the corresponding basic cards cifX.
UL Certification	The device is certified according to UL 508	UL-File-Nr. E221530

Table 148: Technical Data AIFX-CO

### 10.1.33 AIFX-DN

AIFX-DN	Parameter	Value
Part	Name	AIFX-DN
	Part No.	2800.510
	Description	DeviceNet assembly interface (with DeviceNet interface) for the PC cards CIFX 90-DN\F, CIFX 90E-DN\F, CIFX 90E-DN\ET\F, CIFX 90E-DN\MR\F, CIFX 90E-DN\MR\ET\F, CIFX 90E-2DP\DN\ET\F, CIFX 90E-2DP\DN\MR\ET\F, CIFX 90E-2CO\DN\ET\F, CIFX 90E-2CO\DN\MR\ET\F, CIFX 90E-2DN\ET\F, CIFX 90E-2DN\MR\ET\F, CIFX 104C-DN\F, CIFX 104C-DN-R\F
Interface PC Card cifX	Connector	Cable Connector Fieldbus X1 (JST 10FMN-SMT-A-TF(LF)(SN), Pitch 1,0 mm)
DeviceNet Interface	Galvanic Isolation	isolated (optically isolated)
	Isolation Voltage	1000 VDC (tested for 1 minute)
	Connector	CombiCon male Connector, 5-polig
Display	LED Display (on the reverse side of the device)	<b>MNS</b> Module network status (duo LED) The meaning of the MNS LED is depending on loaded firmware. Refer to chapter <i>LED Descriptions</i> , page 94.
Power supply	Connector	Cable Connector Fieldbus X1
Environmental Conditions	Operating temperature range*	-20 °C ... +70 °C
	*Air flow during measurment	0,5m/s
	Storage temperature range	-10 °C ... +70 °C
	Humidity	10 ... 95% relative humidity, no condensation permitted
	Environment	For UL compliant usage: The device must be used in a pollution degree 2 environment.
Device	Dimensions (L x W x H)	23,7 x 31 x 18,5 mm (L = 23,7, without CombiCon male Connector; H = width of the front panel)
	Mounting/Installation	At the basic cards CIFX 90, CIFX 90E, CIFX 90E\ET, CIFX 90E\MR, CIFX 90E\MR\ET: Cable Connector Fieldbus X3; or at CIFX 104C-FB\F, CIFX 104C-FB-R\F: Cable Connector Fieldbus X304 (X4)
	RoHS	Yes
CE Sign	CE Sign	Yes
	Emission, Immunity	Tested together with the corresponding basic cards cifX.
UL Certification	The device is certified according to UL 508	UL-File-Nr. E221530

Table 149: Technical Data AIFX-DN

### 10.1.34 AIFX-CC

AIFX-CC	Parameter	Value
Part	Name	AIFX-CC
	Part No.	2800.730
	Description	CC-Link assembly interface (with CC-Link interface) for the PC cards CIFX 90E-CC\ET\F, CIFX 90E-CC\ET\F, CIFX 90E-CC\MR\ET\F, CIFX 104C-CC\F
Interface PC Card cifX	Connector	Cable Connector Fieldbus X1 (JST 10FMN-SMT-A-TF(LF)(SN), Pitch 1,0 mm)
CC-Link Interface	Galvanic Isolation	isolated (optically isolated)
	Isolation Voltage	1000 VDC (tested for 1 minute)
	Connector	CombiCon male Connector, 5-polig
Display	LED Display (on the reverse side of the device)	<b>L RUN</b> LED L Run (Duo-LED) <b>L ERR</b> LED L Error (Duo-LED) Refer to chapter <i>LED Descriptions</i> , page 94.
Power supply	Connector	Cable Connector Fieldbus X1
Environmental Conditions	Operating temperature range*	0 °C ... +60 °C
	*Air flow during measurment	0,5m/s
	Storage temperature range	-10 °C ... +70 °C
	Humidity	10 ... 95% relative humidity, no condensation permitted
	Environment	For UL compliant usage: The device must be used in a pollution degree 2 environment.
Device	Dimensions (L x W x H)	43,2 x 31 x 18,5 mm (L = 43,2, without CombiCon male Connector; H = width of the front panel)
	Mounting/Installation	At the basic cards CIFX 90, CIFX 90E, CIFX 90E\ET, CIFX 90E\MR, CIFX 90E\MR\ET: Cable Connector Fieldbus X3; or at CIFX 104C-FB\F: Cable Connector Fieldbus X304 (X4)
	RoHS	Yes
CE Sign	CE Sign	Yes
	Emission, Immunity	Tested together with the corresponding basic cards cifX.
UL Certification	The device is certified according to UL 508	UL-File-Nr. E221530

Table 150: Technical Data AIFX-CC

### 10.1.35 AIFX-DIAG

AIFX-DIAG	Parameter	Value
Part	Name	AIFX-DIAG
	Part No.	2800.000
	Description	Diagnostic assembly interface (with diagnostic interface) for the PC cards CIFX 104C-RE\F, CIFX 104C-RE-R\F CIFX 104C-DP\F, CIFX 104C-DP-R\F, CIFX 104C-CO\F, CIFX 104C-CO-R\F, CIFX 104C-DNF, CIFX 104C-DN-R\F, CIFX 104C-CC\F
Interface PC Card cifX	Connector	Cable Connector DIAG X1 (JST 12FMN-SMT-A-TF(LF)(SN), Pitch 1,0 mm)
Diagnosis Interface	USB Interface	Mini B USB Plug (5 pin), refer to section <i>Mini-B USB Connector (5 Pin)</i> , page 127.
Display	LED Display	<b>PWR</b> Supply Voltage ON LED <b>SYS</b> System Status LED  The meaning of the following LEDs depends on the loaded firmware:: <b>COM 0</b> LED Communication Status 0 (duo LED) <b>COM 1</b> LED Communication Status 1 (duo LED) Refer to chapter <i>LED Descriptions</i> , page 94.
Power supply	Connector	Cable Connector DIAG X1
Operation	Rotary Switch Device Address	Is currently unassigned. Refer to section <i>Rotary Switch Device Address</i> on page 127.
Environmental Conditions	Operating temperature range*	-20 °C ... +70 °C
	*Air flow during measurment	0,5m/s
	Storage temperature range	-10 °C ... +70 °C
	Humidity	10 ... 95% relative humidity, no condensation permitted
	Environment	For UL compliant usage: The device must be used in a pollution degree 2 environment.
Device	Dimensions (L x W x H)	20,5 x 52,7 x 18,5 mm (H = width of the front panel)
	Mounting/Installation	At the basic cards CIFX 104C-RE\F, CIFX 104C-RE-R\F, CIFX 104C-FB\F, CIFX 104C-FB-R\F Cable Connector DIAG X303 (X3)
	RoHS	Yes
CE Sign	CE Sign	Yes
	Emission, Immunity	Tested together with the corresponding basic card cifX..
UL Certification	The device is certified according to UL 508	UL-File-Nr. E221530

Table 151: Technical Data AIFX-DIAG

## 10.2 PCI IDs PC Cards cifX on the PCI Bus

On the PCI bus the PC Cards cifX have the following PCI IDs:

PCI IDs	Value
VendorID	0x15CF
DeviceID	0x0000
Subsystem Vendor ID	0x0000
Subsystem Device ID	0x0000

Table 152: PCI IDs PC Cards cifX on the PCI Bus

## 10.3 Supported PCI Bus Commands

From the following table you can see which PCI bus commands are supported by the Hilscher PC Cards cifX *Compact PCI*, *Mini PCI*, *Mini PCI Express* and *PCI-104*.

C/BE3#	C/BE2#	C/BE1#	C/BE0#	Command Type	supported
0	0	0	0	Interrupt Acknowledge	no
0	0	0	1	Special Cycle	no
0	0	1	0	I/O Read	✓
0	0	1	1	I/O Write	✓
0	1	0	0	Reserved	no
0	1	0	1	Reserved	no
0	1	1	0	Memory Read	✓
0	1	1	1	Memory Write	✓
1	0	0	0	Reserved	no
1	0	0	1	Reserved	no
1	0	1	0	Configuration Read	✓
1	0	1	1	Configuration Write	✓
1	1	0	0	Memory Read Multiple	no
1	1	0	1	Dual Address Cycle	no
1	1	1	0	Memory Read Line	no
1	1	1	1	Memory Write and Invalidate	no

Table 153: Supported / not supported PCI Bus Commands

**C/BE** = Bus Command and Byte Enable Signal of PCI

## 10.4 Technical Data of the Communication Protocols

### 10.4.1 EtherCAT Master

Parameter	Description
Maximum number of EtherCAT slaves	Maximum 200 Slaves. The number of usable slaves depends on the available memory for the configuration file. See 'configuration file' below.
Maximum number of cyclic input data	5760 bytes
Maximum number of cyclic output data	5760 bytes
Minimum bus cycle time	205 $\mu$ s, depending on the used number of slaves and the used number of cyclic input data and output data. Recommended is a cycle time of 1 ms and higher.
Acyclic communication	CoE (CANopen over EtherCAT) CoE-Upload, CoE-Download Maximum 1500 bytes
Functions	Get OD List Get object description Get entry description Emergency Slave diagnostics
Bus Scan	Supported
Redundancy	Supported, but not at the same time with Distributed Clocks
Distributed Clocks	Supported, but not at the same time with Redundancy
Topology	Line or ring
Baud rate	100 MBit/s
Data transport layer	Ethernet II, IEEE 802.3
Configuration File (ethercat.xml or config.nxd)	PC cards PCI, PCI Express, PCI Express Low Profile, Mini PCI, Compact PCI, Mini PCI Express, PCI-104 Real-Time Ethernet: Maximum 1 MByte PC cards PC/104 Real-Time Ethernet: Maximum 2 MByte
Limitations	The size of the bus configuration file is limited by the size of the RAM Disk (1 Mbyte) or FLASH disk (2 Mbyte). All CoE Uploads, Downloads and information services must fit in one TLR-Packet. Fragmentation is not supported Distubuted Clock and Redundancy can not be used at the same time.
Reference to firmware/stack version	V3.0.x.x

Table 154: Technical Data EtherCAT Master Protocol

## 10.4.2 EtherCAT Slave

Parameter	Description
Maximum number of cyclic input data	256* bytes
Maximum number of cyclic output data	256* bytes
Acyclic communication	SDO SDO Master-Slave SDO Slave-Slave (depending on Master capability)
Type	Complex Slave
Functions	Emergency
FMMUs	3
SYNC Manager	4
Distributed Clocks (DC)	Supported, 32 Bit
Baud rate	100 MBit/s
Data transport layer	Ethernet II, IEEE 802.3
Limitation	LRW is not supported
Reference to firmware/stack version	V2.5.x.x and V4.2.x.x

Table 155: Technical Data EtherCAT Slave Protocol



**Note:** \* The loadable firmware supports for the number of cyclic input data and for cyclic output data in total up to 512 bytes. If more than 256 bytes for input data or for output data shall be exchanged via EtherCAT, then a customer specific XML file is necessary. Additionally the following formula applies: The sum of the input data length and the output data length may not exceed 512 bytes, where each length has to be rounded up to the next multiple of 4 for this calculation.

### 10.4.3 EtherNet/IP Scanner (Master)

Parameter	Description
Maximum number of EtherNet/IP connections	64 connections for implicit and explicit
Maximum number of total cyclic input data	5712 bytes
Maximum number of total cyclic output data	5760 bytes
Maximum number of cyclic input data	504 bytes per slave per telegram
Maximum number of cyclic output data	504 bytes per slave per telegram
IO Connection type	Cyclic, minimum 1 ms (depending on used number of connections and used number of input and output data)
Maximum number of unscheduled data	1400 bytes per telegram
UCMM, Class 3	Supported
Explicit Messages, Client and Server Services	Get_Attribute_Single/All Set_Attribute_Single/All
Quick connect	Supported
Predefined standard objects	Identity Object Message Route Object Assembly Object Connection Manager Ethernet Link Object TCP/IP Object DLR Object QoS Object
Maximal number of user specific objects	20
Topology	Tree, Line, Ring
DLR (Device Level Ring)	Beacon based 'Ring Node'
ACD (Address Conflict Detection)	Supported
DHCP	Supported
BOOTP	Supported
Baud rates	10 and 100 MBit/s
Data transport layer	Ethernet II, IEEE 802.3
Switch function	Integrated
Limitations	CIP Sync Services are not implemented TAGs are not supported
Reference to firmware/stack version	V2.6.x.x

Table 156: Technical Data EtherNet/IP Scanner (Master) Protocol



### 10.4.4 EtherNet/IP Adapter (Slave)

Parameter	Description
Maximum number of input data	504 bytes
Maximum number of output data	504 bytes
IO connection types (implicit)	1 exclusive owner, 1 listen only, 1 input only
IO Connection trigger types	Cyclic, minimum 1 ms* Application Triggered, minimum 1 ms* Change Of State, minimum 1 ms* * depending on number of connections and number of input and output data
Explicit Messages	Connected and unconnected
Maximum number of connections	8, explicit and implicit connections
Unconnected Message Manager (UCMM)	Supported
Quick connect	Supported
Predefined standard objects	Identity Object Message Route Object Assembly Object Connection Manager DLR Object QoS Object TCP/IP Object Ethernet Link Object
Reset services	Identity Object Reset Service of Type 0 and 1
Maximum number of user specific objects	20
DLR V2 (ring topology)	Supported
ACD (Address Conflict Detection)	Supported
DHCP	Supported
BOOTP	Supported
Baud rates	10 and 100 MBit/s
Duplex modes	Half duplex, Full duplex, Auto negotiation
MDI modes	MDI, MDI-X, Auto-MDIX
Data transport layer	Ethernet II, IEEE 802.3
Switch function	Integrated
Limitations	CIP Sync Services are not implemented TAGs are not supported
Reference to firmware/stack version	V2.7.x.x

Table 157: Technical Data EtherNet/IP Adapter (Slave) Protocol

### 10.4.5 Open Modbus/TCP

Parameter	Description
Maximum number of input data	2880 Registers
Maximum number of output data	2880 Registers
Acyclic communication	Read/Write Register: - Maximum 125 Registers per Read Telegram (FC 3, 4, 23), - Maximum 121 Registers per Write Telegram (FC 23), - Maximum 123 Registers per Write Telegram (FC 16)  Read/Write Coil: - Maximum 2000 Coils per Read Telegram (FC 1, 2), - Maximum 1968 Coils per Write Telegram (FC 15)
Modbus Function Codes	1, 2, 3, 4, 5, 6, 7, 15, 16, 23*  * Function Code 23 can be used via the packet API, but not with the Command Table.
Protocol Mode	Message Mode (Client Mode): - Client (using the Command Table: The data is stored in the I/O process data image) - Client (using the packet API: The I/O process data image is not used) - Server (using the packet API: The I/O process data image is not used)  I/O Mode (Server Mode): - Server (only) (The data is stored in the I/O process data image)
Baud rates	10 and 100 MBit/s
Data transport layer	Ethernet II, IEEE 802.3
Reference to firmware/stack version	V2.5.x.x

Table 158: Technical Data Open Modbus/TCP Protocol

### 10.4.6 POWERLINK Controlled Node/Slave

Parameter	Description
Maximum number of cyclic input data	1490 bytes
Maximum number of cyclic output data	1490 bytes
Acyclic data transfer	SDO Upload/Download
Functions	SDO over ASND and UDP
Baud rate	100 MBit/s, half-duplex
Data transport layer	Ethernet II, IEEE 802.3
Ethernet POWERLINK version	V 2
Limitation	No slave to slave communication
Reference to firmware/stack version	V2.1.x.x

Table 159: Technical Data POWERLINK Controlled Node (Slave) Protocol

### 10.4.7 PROFINET IO-Controller

Parameter	Description
Maximum number of PROFINET IO Devices	128
Maximum number of total cyclic input data	5712 bytes (including IOxS status bytes)
Maximum number of total cyclic output data	5760 bytes (including IOxS status bytes)
Maximum number of cyclic input data	1440 bytes per device (= IOCR data length including IOxS status bytes)
Maximum number of cyclic output data	1440 bytes per device (= IOCR data length including IOxS status bytes)
Acyclic communication	Read/Write Record Limited to 1392 bytes per telegram Limited to 4096 bytes per request
Alarm processing	yes, but requires handling in host application program
Diagnostic data	One 200 byte buffer per IO device
DCP functions via API	Name Assignment IO-Devices (DCP SET NameOfStation) Set IO-Devices IP (DCP SET IP) Signal IO-Device (DCP SET SIGNAL) Reset IO-Device to factory settings (DCP Reset FactorySettings) Bus scan (DCP IDENTIFY ALL)
Supported Protocols	RTC – Real Time Cyclic Protocol, Class 1 RTA – Real Time Acyclic Protocol DCP – Discovery and configuration Protocol CL-RPC – Connectionless Remote Procedure Call
Context management by CL-RPC	Supported
Minimum cycle time	1 ms Different IO-Devices can be configured with different cycle times
Functions	Fast Startup of PROFINET IO Devices supported
Baud rate	100 MBit/s Full-Duplex mode
Data transport layer	Ethernet II, IEEE 802.3
Configuration file	Maximum 1 MByte
Limitations	RT over UDP not supported Multicast communication not supported DHCP is not supported (neither for PROFINET IO-Controller nor for the IO-Devices) Only one IOCR per IO Device NameOfStation of IO Controller CANNOT be set using the DCP SET NameOfStation service but only at start-up while configuring the IO Controller The buffer for IO-Device diagnosis data will be overwritten in case of multiple diagnostic events. Only one (the last) event is stored at the same time. If a single event produces more than 200 bytes of diagnosis data, only the first 200 bytes will be taken care of. The usable (minimum) cycle time depends on the number of used IO Devices, the number of used input and output data. The cycle-time, the number of configured IO Devices and the amount of IO data depend on each other. For example it is not possible due to performance reasons to have 128 IO Devices communication with cycle-time 1ms. The size of the bus configuration file is limited by the size of the RAM Disk (1 MByte) WriteMultiple-Record service is not supported

Parameter	Description
Reference to firmware/stack version	V2.6.x.x

Table 160: Technical Data PROFINET IO RT Controller

### 10.4.8 PROFINET IO-Device (V3.4)

Parameter	Description
Maximum number of cyclic input data	1024 bytes
Maximum number of cyclic output data	1024 bytes
Acyclic communication	Read/Write Record, max. 1024 bytes per telegram
Alarm Types	Process Alarm, Diagnostic Alarm, Return of SubModule Alarm Plug Alarm (implicit), Pull Alarm (implicit)
Supported protocols	RTC – Real Time Cyclic Protocol, Class 1 and 2 (unsynchronized), Class 3 (synchronized) RTA – Real Time Acyclic Protocol DCP – Discovery and configuration Protocol CL-RPC – Connectionless Remote Procedure Call LLDP – Link Layer Discovery Protocol SNMP – Simple Network Management Protocol MRP – MRP Client
Used Protocols (subset)	UDP, IP, ARP, ICMP (Ping)
Topology recognition	LLDP, SNMP V1, MIB2, physical device
VLAN- and priority tagging	yes
Context Management by CL-RPC	Supported
Identification & Maintenance	Read and write of I&M1-4
Minimum cycle time	1 ms for RTC1 and RTC2 250 µs for RTC3
Baud rate	100 MBit/s
Data transport layer	Ethernet II, IEEE 802.3
Limitations	RT over UDP not supported Multicast communication not supported Only one device instance is supported DHCP is not supported IRT “flex” (synchronized RT Class 2) is not supported FastStartUp is not supported. Media Redundancy (except MRP client) is not supported Access to the submodule granular status bytes (IOCS) is not supported. The amount of configured IO-data influences the minimum cycle time that can be reached. Supervisor-AR is not supported, Supervisor-DA-AR is supported Only 1 Input-CR and 1 Output-CR are supported Multiple WriteRequests are not supported Using little endian (LSB-MSB) byte order for cyclic process data instead of default big endian (MSB-LSB) byte order may have an negative impact on minimum reachable cycle time
Reference to firmware/stack version	V3.4.x.x

Table 161: Technical Data PROFINET IO RT IRT Device Protocol

### 10.4.9 PROFINET IO-Device (V3.5)

Parameter	Description
Maximum number of cyclic input data	1440 bytes
Maximum number of cyclic output data	1440 bytes
Maximum number of submodules	255 submodules per Application Relation at the same time, 1000 submodules can be configured
Multiple Application Relations (AR)	The Stack can handle up to 2 IO-ARs, one Supervisor AR and one Supervisor-DA AR at the same time
Acyclic communication	Read/Write Record, max. 1024 bytes per telegram
Alarm Types	Process Alarm, Diagnostic Alarm, Return of SubModule Alarm, Plug Alarm (implicit), Pull Alarm (implicit)
Supported protocols	RTC – Real Time Cyclic Protocol, class 1 (unsynchronized), class 3 (synchronized) RTA – Real Time Acyclic Protocol DCP – Discovery and configuration Protocol CL-RPC – Connectionless Remote Procedure Call LLDP – Link Layer Discovery Protocol SNMP – Simple Network Management Protocol MRP – MRP Client
Topology recognition	LLDP, SNMP V1, MIB2, physical device
Identification & Maintenance	Read and write of I&M1-4
Minimum cycle time	1 ms for RT_CLASS_1 250 µs for RT_CLASS_3
IRT Support	RT_CLASS_3
Media Redundancy	MRP client is supported
Additional features	DCP, VLAN- and priority tagging, Shared Device
Baud rate	100 MBit/s
Data transport layer	Ethernet II, IEEE 802.3
PROFINET IO specification	V2.2 (legacy startup) and V2.3 (but advanced startup only for RT) are supported
Limitations	RT over UDP not supported Multicast communication not supported Only one device instance is supported DHCP is not supported FastStartUp is not supported The amount of configured IO-data influences the minimum cycle time that can be reached. Only 1 Input-CR and 1 Output-CR are supported Using little endian (LSB-MSB) byte order for cyclic process data instead of default big endian (MSB-LSB) byte order may have a negative impact on minimum reachable cycle time System Redundancy (SR-AR) and Configuration-in-Run (CiR) are not supported Max. 255 submodules can be used simultaneously within one specific Application Relation Advanced Startup according Profinet specification V2.3 is NOT yet supported for IRT As there is no official certification available for Profinet IO specification V2.3 at the time of release of the stack there is no guarantee that this implementation will pass such a certification once it is available
Reference to firmware/stack version	V3.5.26.x

Table 162: Technical Data PROFINET IO RT IRT Device Protocol

### 10.4.10 sercos Master

Parameter	Description
Maximum number of cyclic input data	5760 bytes (including Connection Control per Connection)
Maximum number of cyclic output data	5760 bytes (including Connection Control per Connection)
Maximum number of configured slave devices	511
Minimum cycle time	250 µs
Acyclic communication	Service channel: Read/Write/Commands
Functions	Bus Scan
Communication phases	NRT, CP0, CP1, CP2, CP3, CP4
Topology	Line and double ring
Redundancy	supported
NRT channel	supported
Hot-Plug	supported
Cross Communication	supported, but only if the master is configured by the host application program by packets.
Baud rate	100 MBit/s, full duplex
Data transport layer	Ethernet II, IEEE 802.3
Auto crossover	supported
Supported sercos version	Communication Specification Version 1.3
TCP/IP stack	integrated
Reference to firmware/stack version	V2.1.x.x

Table 163: Technical Data sercos Master Protocol

### 10.4.11 sercos Slave

Parameter	Description
Maximum number of cyclic input data (Tx) of all slaves	128 bytes (including Connection Control and IO Status)
Maximum number of cyclic output data (Rx) of all slaves	128 bytes (including Connection Control and IO Status)
Maximum number of slave devices	8
Maximum number of applicable sercos addresses	1 ... 511
Minimum cycle time	250 µs
Topology	Line and ring
Communication phases	NRT, CP0, CP1, CP2, CP3, CP4
Acyclic Communication (Service Channel)	Read/Write/Standard Commands
Baud rate	100 MBit/s
Data transport layer	Ethernet II, IEEE 802.3
Supported sercos version	sercos in the third generation Communication Specification Version 1.1.2
Supported sercos Communication Profiles	SCP_FixCFG Version 1.1.1 SCP_VarCFG Version 1.1.1 SCP_VarCFG Version 1.1.3
Supported User SCP Profiles	SCP_WD Version 1.1.1 SCP_Diag Version 1.1.1 SCP_RTb Version 1.1.1 SCP_Mux Version 1.1.1 SCP_Sig Version 1.1.1 SCP_ExtMuX Version 1.1.2 SCP_RTbListProd Version 1.3 SCP_RTbListCons Version 1.3 SCP_RTbWordProd Version 1.3 SCP_RTbWordCons Version 1.3 SCP_OvSBasic Version 1.3 SCP_WDCon Version 1.3
Supported FSP profiles	FSP_IO FSP_Drive
SCP Sync	Supported
SCP_NRT	Supported
S/IP	Supported
Identification LED	Supported
Storage location of object dictionary	Mixed mode
Limitations	Max. 2 connections: 1 for consumer and 1 for producer Modifications of the Service-Channel Object Dictionary will be volatile after reset (if it resides on device) Hot plug is not supported yet Cross communication not supported yet
Reference to firmware/stack version	V3.1.x.x

Table 164: Technical Data sercos Slave Protocol

### 10.4.12 VARAN Client (Slave)

Parameter	Description
Maximum number of cyclic input data	128 bytes
Maximum number of cyclic output data	128 bytes
Memory Area	Read Memory Area 1, Write Memory Area 1
Functions	Memory Read Memory Write
Integrated 2 port splitter for daisy chain topology	Supported
Baud rate	100 MBit/s
Data transport layer	Ethernet II, IEEE 802.3
VARAN protocol version	1.1.1.0
Limitations	Integrated EMAC for IP data exchange with client application not supported SPI single commands (optional feature) not supported Memory area 2 is not supported.
Reference to firmware/stack version	V1.0.x.x

Table 165: Technical Data VARAN Client Protocol



### 10.4.13 PROFIBUS DP Master

Parameter	Description
Maximum number of PROFIBUS DP slaves	125 (DPV0/DPV1)
Maximum number of total cyclic input data	5712 bytes
Maximum number of total cyclic output data	5760 bytes
Maximum number of cyclic input data	244 bytes per slave
Maximum number of cyclic output data	244 bytes per slave
Configuration data	Max. 244 bytes per slave
Parameterization data per slave	7 bytes standard parameter per slave Max. 237 bytes application specific parameters per slave
Acyclic communication	DPV1 class 1 read, write DPV1 class 1 alarm DPV1 class 2 initiate, read, write, data transport, abort
Maximum number of acyclic read/write	240 bytes per slave and telegram
Functions	Configuration in Run (CiR), requires host application program support Timestamp (Master functionality)
Redundancy	Supported, requires host application program support
Baud rate	9,6 kBits/s, 19,2 kBits/s, 31,25 kBits/s, 45,45 kBits/s 93,75 kBits/s, 187,5 kBits/s, 500 kBits/s, 1, 5 MBits/s, 3 MBits/s, 6 MBits/s, 12 MBit/s  Auto baud rate detection is not supported
Data transport layer	PROFIBUS FDL
Limitations	DPV2 isochronous mode and slave slave communication are not supported.  The redundancy function can not be used, if the master is configured by the host application program by packets.
Reference to firmware/stack version	V2.6.x.x

Table 166: Technical Data PROFIBUS DP Master Protocol

### 10.4.14 PROFIBUS DP Slave

Parameter	Description
Maximum number of cyclic input data	244 bytes
Maximum number of cyclic output data	244 bytes
Maximum number of acyclic data (read/write)	240 bytes/telegram
Maximum number of modules	24
Configuration data	Max. 244 bytes
Parameter data	237 bytes application specific parameters
Acyclic communication	DP V1 Class 1 Read/Write DP V1 Class 1 Alarm DP V1 Class 2 Read/Write/Data Transport
Baud rate	9,6 kBits/s, 19,2 kBits/s, 31,25 kBits/s, 45,45 kBits/s, 93,75 kBits/s, 187,5 kBits/s, 500 kBits/s, 1, 5 MBits/s, 3 MBits/s, 6 MBits/s, 12 MBit/s Auto baudrate detection is supported
Data transport layer	PROFIBUS FDL
Limitations	SSCY1S – Slave to slave communication state machine not implemented Data exchange broadcast not implemented I&M LR services other than Call-REQ/RES are not supported yet
Reference to firmware/stack version	V2.7.x.x

Table 167: Technical Data PROFIBUS DP Slave Protocol

### 10.4.15 PROFIBUS MPI

Parameter	Description
Maximum number of MPI connections	126
Maximum number of write data	216 bytes
Maximum number of read data	222 bytes
Functions	MPI Read/Write DB (data block), M (marker), Q (output), C (Counter), T (Timer) MPI Read I (Input) Data type bit to access to DB (data block), M (marker), Q (output) and I (Input, read only) MPI Connect (automatically when first read/write function is used) MPI Disconnect, MPI Disconnect All MPI Get OP Status MPI transparent (expert use only)
Baud rate	Fixed values ranging from 9,6 kBits/s to 12 MBit/s Auto-detection mode is supported
Data transport layer	PROFIBUS FDL
Reference to firmware/stack version	2.4.x.x

Table 168: Technical Data PROFIBUS-MPI Protocol

### 10.4.16 CANopen Master

Parameter	Description
Maximum number of CANopen nodes	126
Maximum number of cyclic input data	3584 bytes
Maximum number of cyclic output data	3584 bytes
Maximum number of receive PDOs	512
Maximum number of transmit PDOs	512
Exchange of process data	Via PDO transfer: - synchronized, - remotely requested and - event driven (change of date)
Acyclic communication	SDO Upload/Download, max. 512 bytes per request
Functions	Emergency message (consumer and producer) Node guarding / life guarding, heartbeat PDO mapping NMT Master SYNC protocol (producer) Simple boot-up process, reading object 1000H for identification
Baud rates	10 kBits/s, 20 kBits/s, 50 kBits/s, 100 kBits/s, 125 kBits/s, 250 kBits/s, 500 kBits/s, 800 kBits/s, 1 MBits/s
CAN layer 2 access	Send/receive via API supported (11 bit/29 bit)
Data transport layer	CAN Frames
CAN Frame type for CANopen	11 Bit
Reference to version	V2.11.x.x

Table 169: Technical Data CANopen Master Protocol

### 10.4.17 CANopen Slave

Parameter	Description
Maximum number of cyclic input data	512 bytes
Maximum number of cyclic output data	512 bytes
Maximum number of receive PDOs	64
Maximum number of transmit PDOs	64
Exchange of process data	Via PDO transfer - synchronized, - remotely requested and - event driven (change of date, event timer) On request of the host application program by packet
Acyclic communication	SDO upload/download (server only) Emergency message (producer) Timestamp (producer/consumer)
Functions	Node guarding / life guarding Heartbeat: 1 producer, max. 64 consumer PDO mapping NMT Slave SYNC protocol (consumer) Error behaviour (configurable): - in state operational: change to state pre-operational - in any state: no state change - in state operational or pre-operational: change to state stopped
Baud rates	10 kBits/s, 20 kBits/s, 50 kBits/s, 100 kBits/s, 125 kBits/s, 250 kBits/s, 500 kBits/s, 800 kBits/s, 1 MBits/s Auto baudrate detection is supported
CAN layer 2 access	Send/receive via API supported (11 bit/29 bit)
Data transport layer	CAN Frames
CAN Frame type for CANopen	11 Bit
Reference to firmware/stack version	V3.6.x.x

Table 170: Technical Data CANopen Slave Protocol

### 10.4.18 DeviceNet Master

Parameter	Description
Maximum number of DeviceNet slaves	63
Maximum number of total cyclic input data	3584 bytes
Maximum number of total cyclic output data	3584 bytes
Maximum number of cyclic input data	255 bytes/connection
Maximum number of cyclic output data	255 bytes/connection
Maximum Configuration data	1000 bytes/slave
Acyclic communication	Explicit connection All service codes are supported
Connections	Bit Strobe Change of State Cyclic Poll Explicit Peer-to-Peer Messaging
Function	Quick Connect
Fragmentation	Explicit and I/O
UCMM	Supported
Objects	Identity Object (Class Code 0x01) Message Router Object (Class Code 0x02) DeviceNet Object (Class Code 0x03) Connection Object (Class Code 0x05) Acknowledge Handler Object (Class Code 0x06)
Baud rates	125 kBits/s, 250 kBit/s, 500 kBit/s Auto baudrate detection is not supported
Data transport layer	CAN frames
Reference to firmware/stack version	V2.3.x.x

Table 171: Technical Data DeviceNet Master Protocol

### 10.4.19 DeviceNet Slave

Parameter	Description
Maximum number of cyclic input data	255 bytes
Maximum number of cyclic output data	255 bytes
Acyclic communication	Get_Attribute_Single/All Max. 240 bytes per request Set_Attribute_Single/All Max. 240 bytes per request
Connections	Poll Change-of-state Cyclic Bit-strobe
Explicit messaging	Supported
Fragmentation	Explicit and I/O
UCMM	Not supported
Baud rates	125 kBits/s, 250 kBit/s, 500 kBit/s Auto baudrate detection is not supported
Data transport layer	CAN frames
Reference to firmware/stack version	V2.3.x.x

Table 172: Technical Data DeviceNet Slave Protocol

### 10.4.20 CC Link Slave

Parameter	Description
<b>Firmware works according to CC-Link Version 2.0:</b>	
Station Types	Remote Device Station (up to 4 occupied stations)
Maximum input data	368 bytes
Maximum output data	368 bytes
Input data remote device station	112 bytes (RY) and 256 bytes (RWw)
Output data remote device station	112 bytes (RX) and 256 bytes (RWr)
Extension cycles	1, 2, 4, 8
Baud rates	156 kBit/s, 625 kBit/s, 2500 kBit/s, 5 MBit/s, 10 MBit/s
Limitation	Intelligent Device Station not supported
<b>Firmware works according to CC-Link Version 1.11:</b>	
Station Types	Remote I/O station, Remote device station' (up to 4 occupied stations)
Maximum input data	48 bytes
Maximum output data	48 bytes
Input data remote I/O station	4 bytes (RY)
Output data remote I/O station	4 bytes (RX)
Input data remote device station	4 bytes (RY) and 8 bytes (RWw) per occupied station
Output data remote device station	4 bytes (RX) and 8 bytes (RWr) per occupied station
Baud rates	156 kBit/s, 625 kBit/s, 2500 kBit/s, 5 MBit/s, 10 MBit/s
Firmware	
Reference to firmware/stack version	V2.9.x.x

Table 173: Technical Data CC-Link-Slave Protocol



# 11 Annex

## 11.1 Device Label with Matrix or Bar Code

You can identify your device by means of the device label.



**Note:** The position of the device label on your device can be seen from the device drawing.

The device label consists of a matrix code or bar code and the information contained therein in plain text.

The 2 D code (Data Matrix Code) contains the following information:

- ① Part number: 1234.567
- ② Hardware revision: 1
- ③ Serial number: 20000 (for mini matrix 20001)

The device label with matrix code can be designed as mini-sticker.

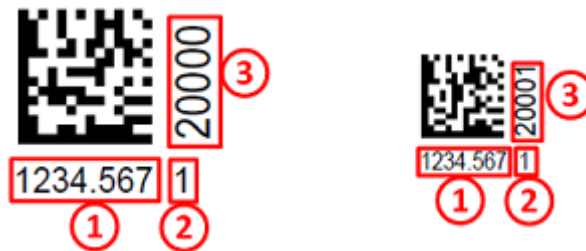

Figure 63: Example 2D Label (mini sticker on the right)

The bar code (EAN 39) contains the following information:

- ① Part number: 1234.567
- ② Hardware revision: 1
- ③ Serial number: 20002
- ④ Security code: X



Figure 64: Example Barcode Label (EAN 39)

## 11.2 Tolerances of the shown Card Dimensions

The manufacturing tolerance of the printed circuit boards of the PC card cifX is  $\pm 0.1$  mm per milled PCB edge. For all dimensions of the PCB indicated on the drawings (in the sections *Dimensioning PC Cards cifX Compact PCI* from page 219, *Dimensioning PC Cards cifX Mini PCI and Mini PCI Express* from page 223, *Dimensioning PC Cards cifX PCI-104* from page 224 and *Dimensioning AIFX Assembly Interfaces* from page 231) thus results for the length L and the width W, a tolerance of  $\pm 0.1$  mm (per milled edge)  $\times 2 = \pm 0.2$  mm.

$$W = [\text{width of the board in mm}] \pm 0.2 \text{ mm}$$

$$L = [\text{length of the board in mm}] \pm 0.2 \text{ mm}$$

The depth T of the PCB depends on the highest part used or the circuit board plus the descenders. The thickness of the PCB is  $= 1.6 \text{ mm} \pm 10\%$ .



**Note:** The dimensions (L x W x D) specified in section *Technical Data PC Cards cifX* on page 139 (and also the identical values in the data sheet cifX and on the 'Hilscher Site') are rounded and unified for the respective types of card. The depth of the PC cards Compact PCI (CIFX 80) has been equated to the rounded width of the front panel.

# 11.3 Dimensioning PC Cards cifX Compact PCI

## 11.3.1 CIFX 80-RE

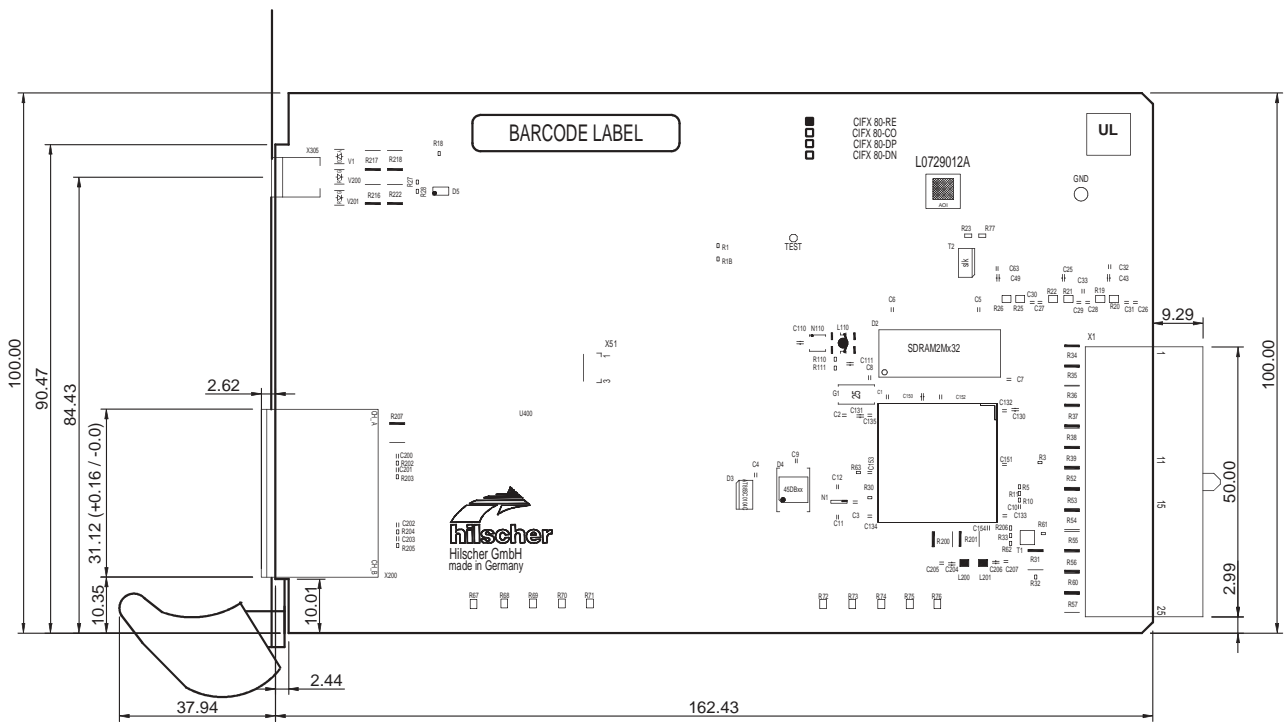

Figure 65: Dimensions CIFX 80E-RE

## 11.3.2 Front Panel CIFX 80-RE

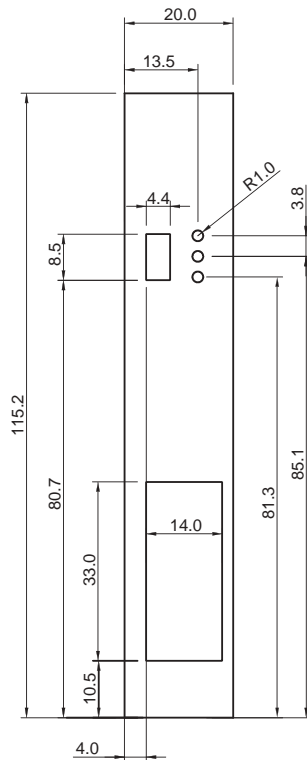

Figure 66: Dimensions Front Panel for CIFX 80-RE

### 11.3.3 CIFX 80-DP

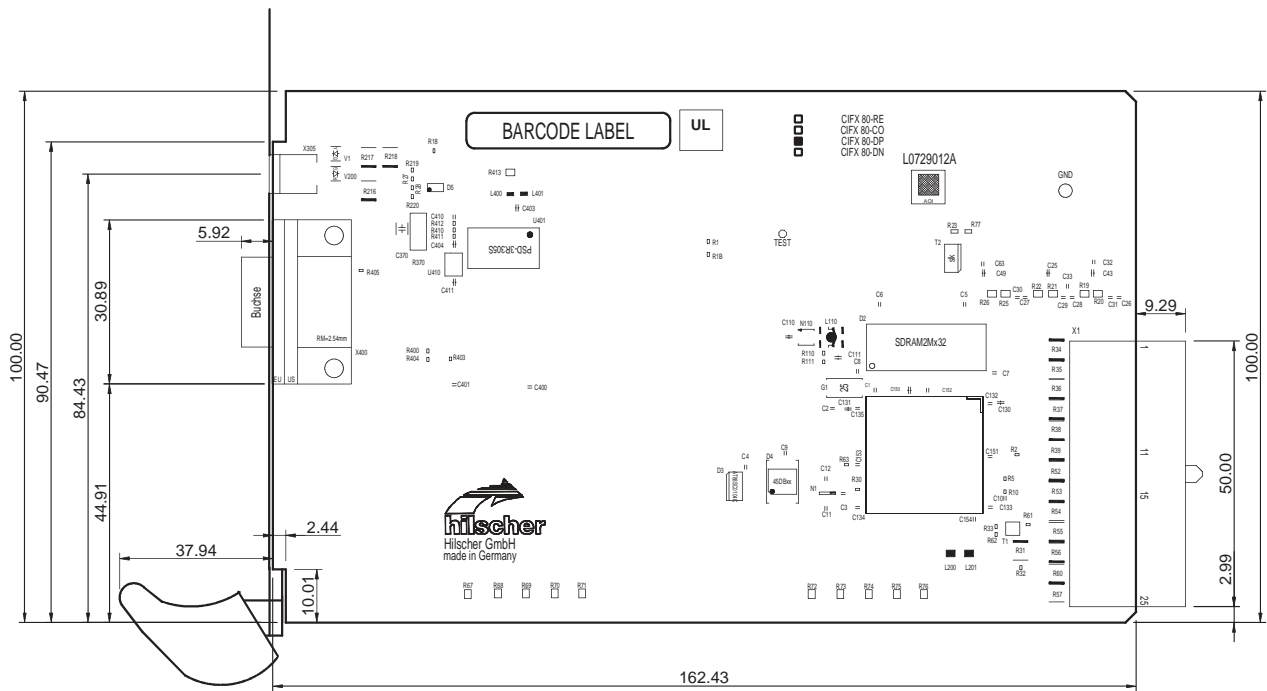

Figure 67: Dimensions CIFX 80-DP

### 11.3.4 Front Panel CIFX 80-DP

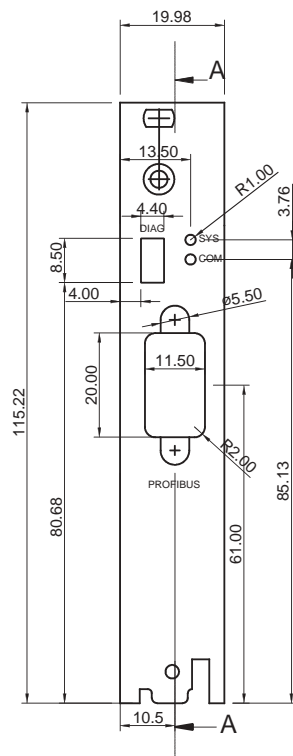

Figure 68: Front Panel for CIFX 80-DP

### 11.3.5 CIFX 80-CO

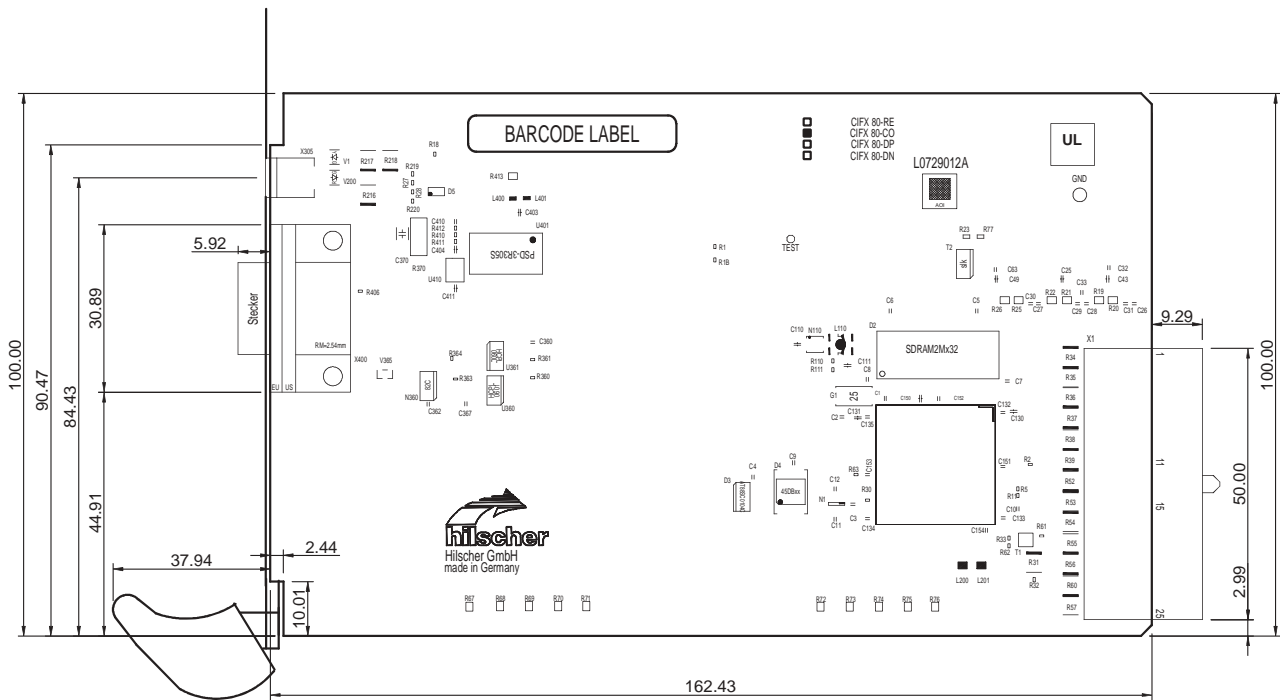

Figure 69: Dimensions CIFX 80-CO

### 11.3.6 Front Panel CIFX 80-CO

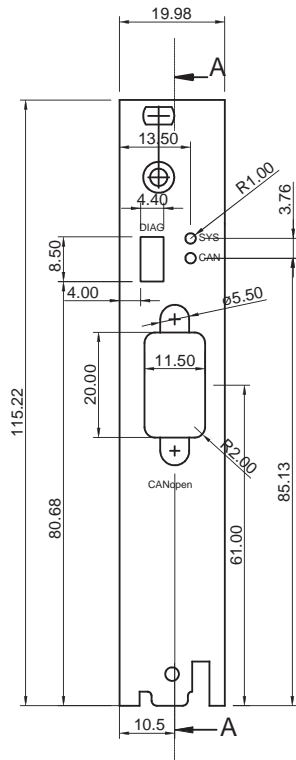

Figure 70: Dimensions Front Panel for CIFX 80-CO

### 11.3.7 CIFX 80-DN

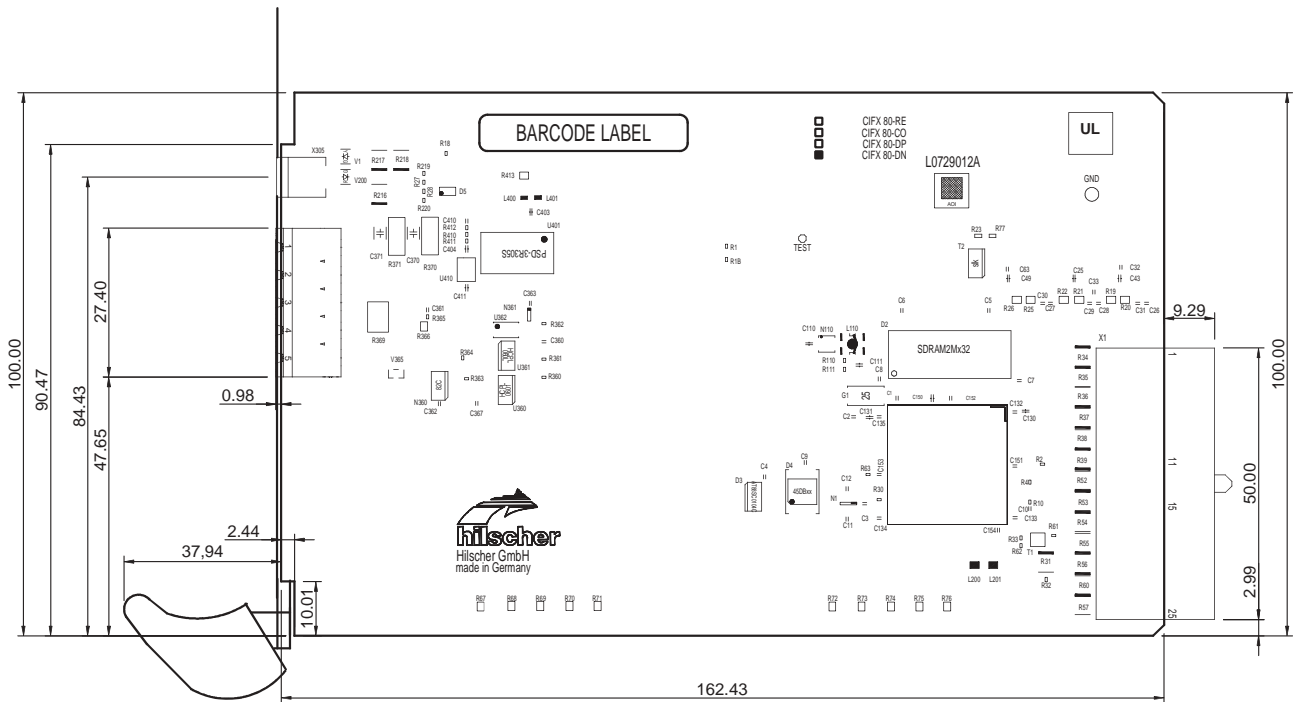

Figure 71: Dimensions CIFX 80-DN

### 11.3.8 Front Panel CIFX 80-DN

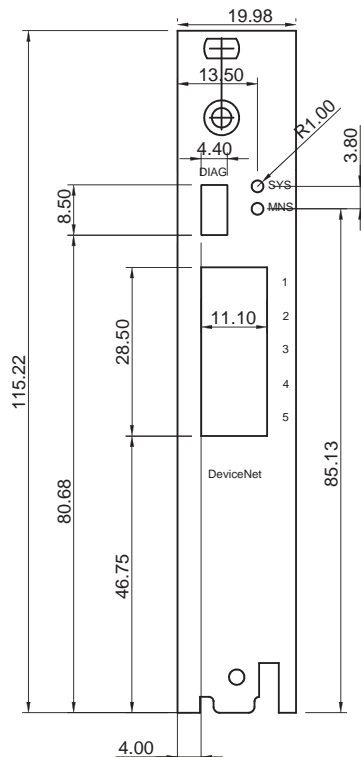

Figure 72: Dimensions Front Panel CIFX 80-DN

# 11.4 Dimensioning PC Cards cifX Mini PCI and Mini PCI Express

## 11.4.1 CIFX 90-XX\F and Variants

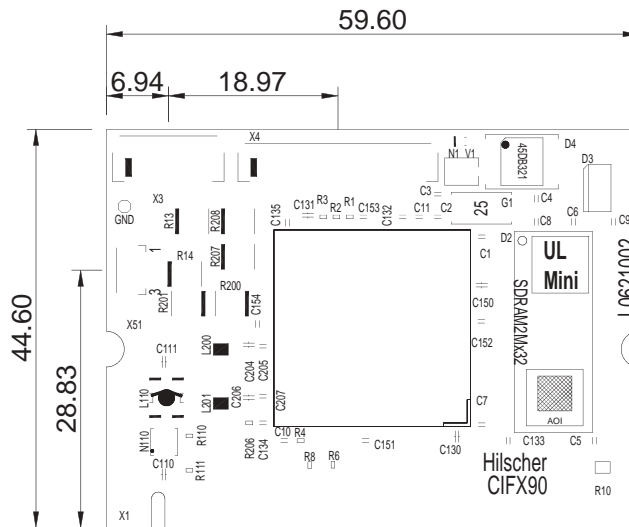

Figure 73: Dimensions CIFX 90-XX\F and Variants

## 11.4.2 CIFX 90E-XX\F and Variants

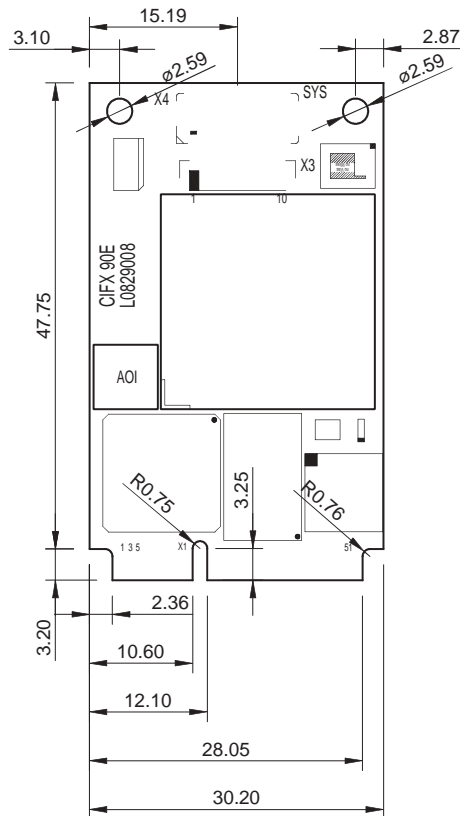

Figure 74: Dimensions CIFX 90E-XX\F and Variants



**Note:** The matrix label is positioned on the reverse side of the card, refer to section *Reverse Side CIFX 90-XX\F, CIFX 90E-XX\F and Variants* on page 64.

# 11.5 Dimensioning PC Cards cifX PCI-104

## 11.5.1 CIFX 104C-RE

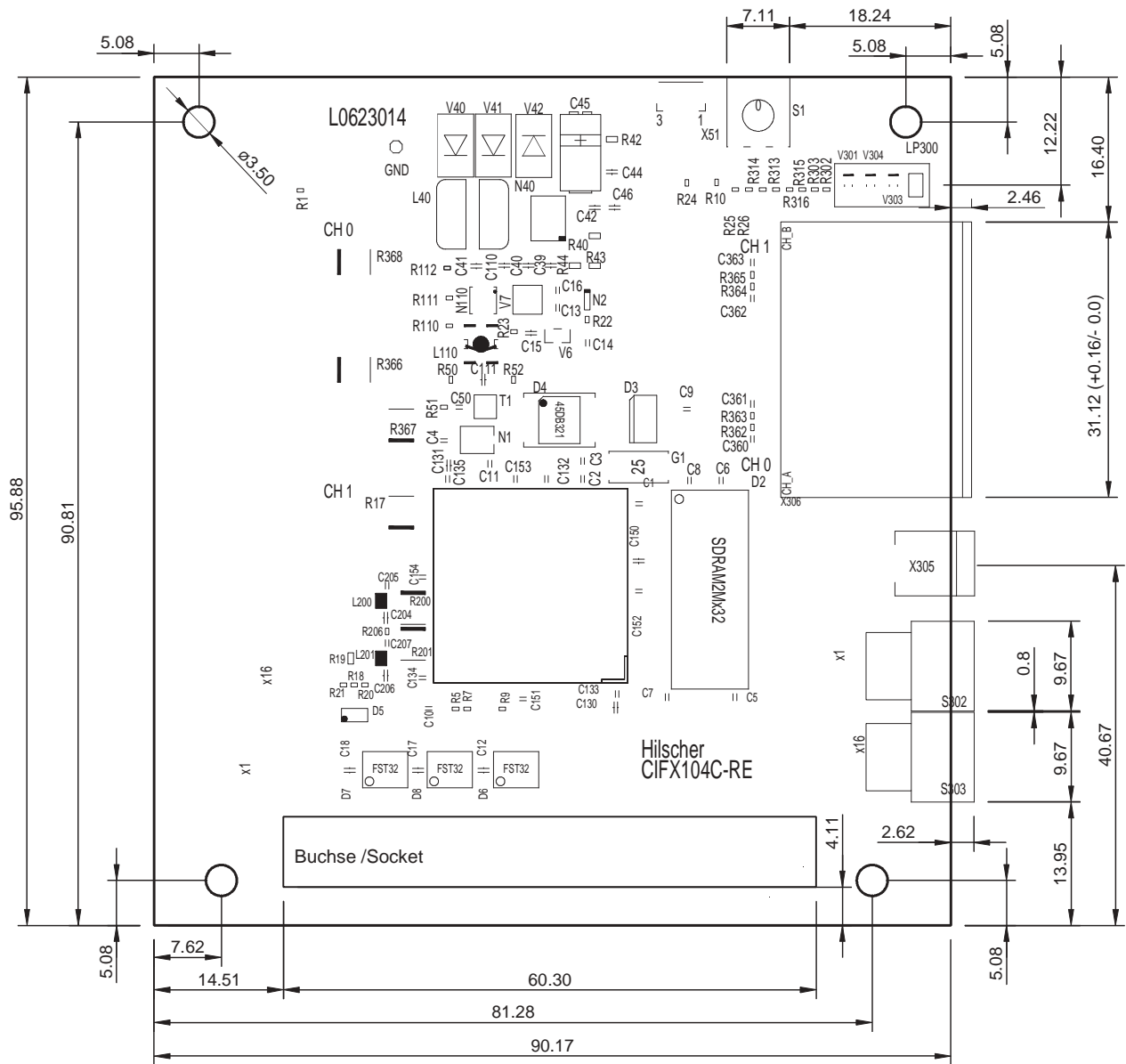

Figure 75: Dimensions CIFX 104C-RE



### 11.5.2 CIFX 104C-REIF

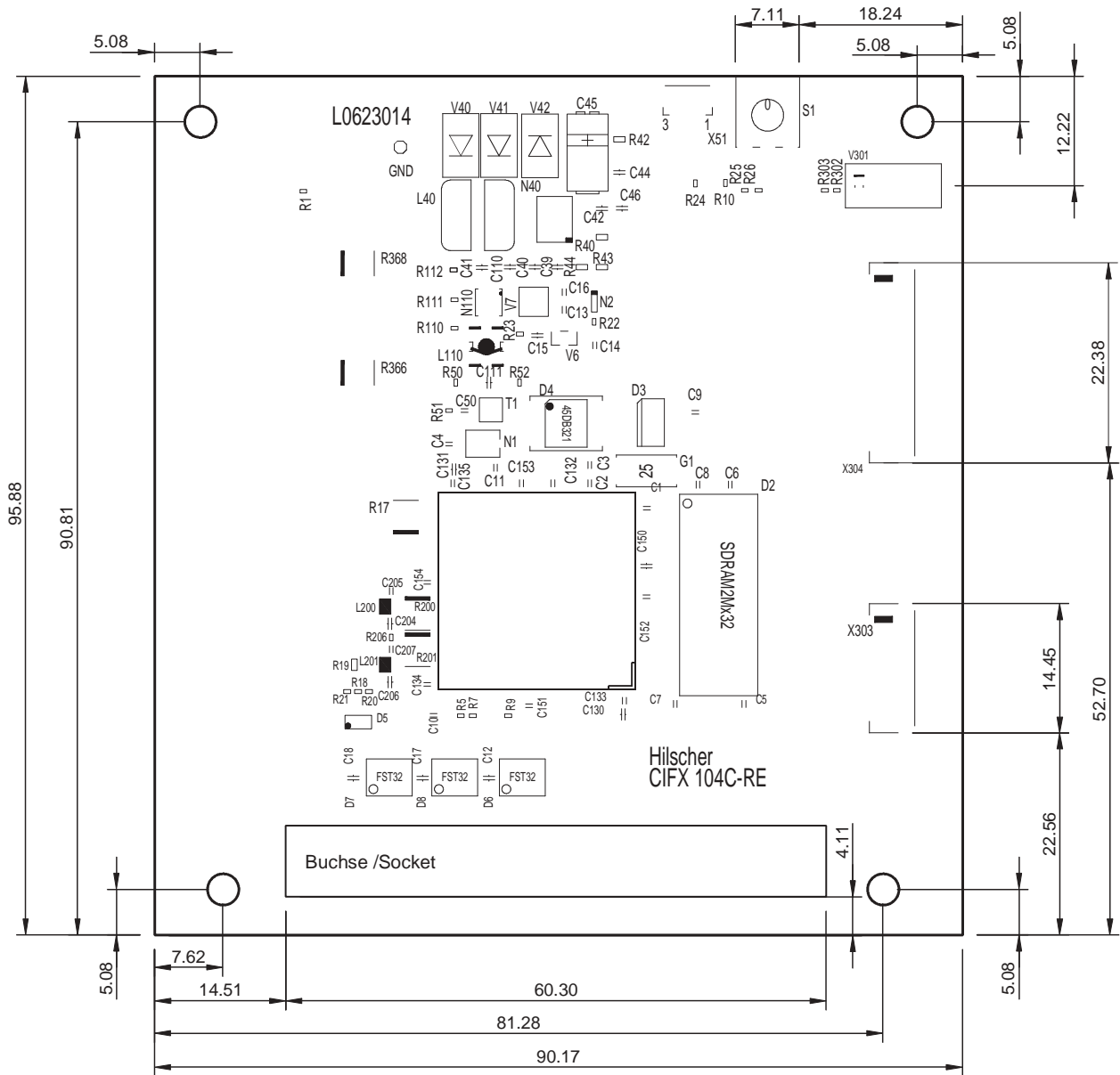

Figure 76: Dimensions CIFX 104C-REIF

### 11.5.3 CIFX 104C-DP

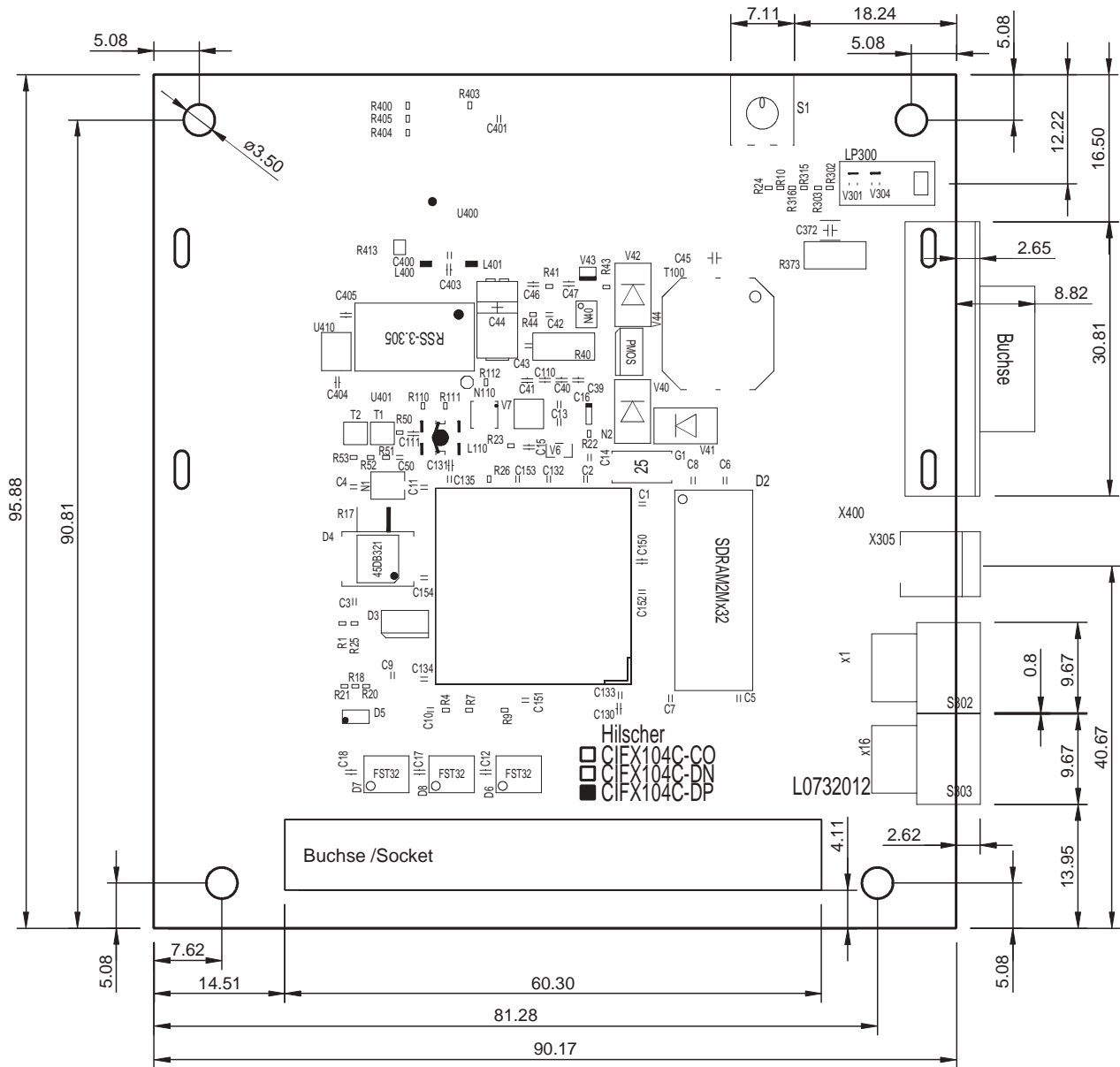

Figure 77: Dimensions CIFX 104C-DP

### 11.5.4 CIFX 104C-CO

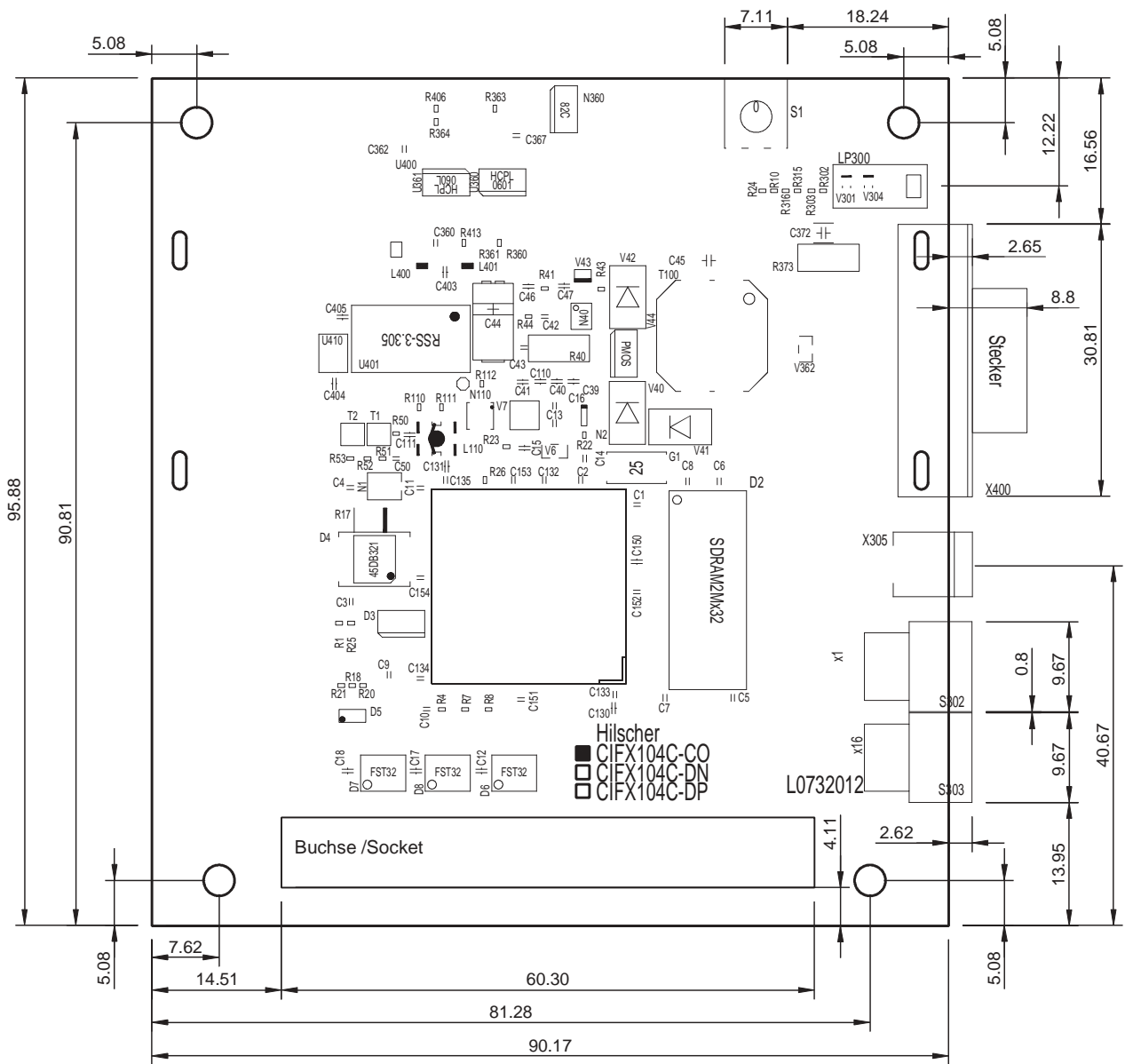

Figure 78: Dimensions CIFX 104C-CO

### 11.5.5 CIFX 104C-DN

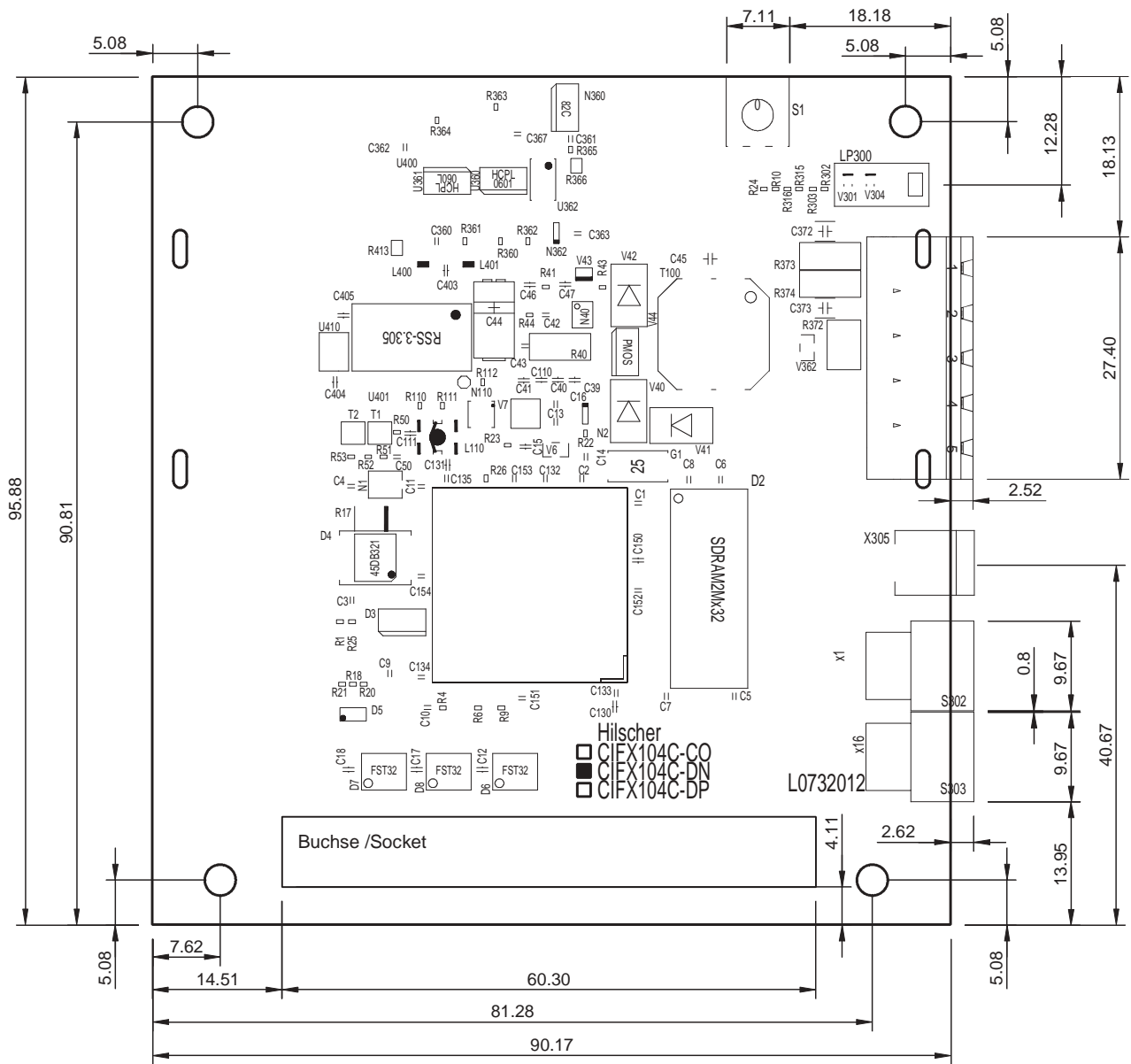

Figure 79: Dimensions CIFX 104C-DN

### 11.5.6 CIFX 104C-FBIF

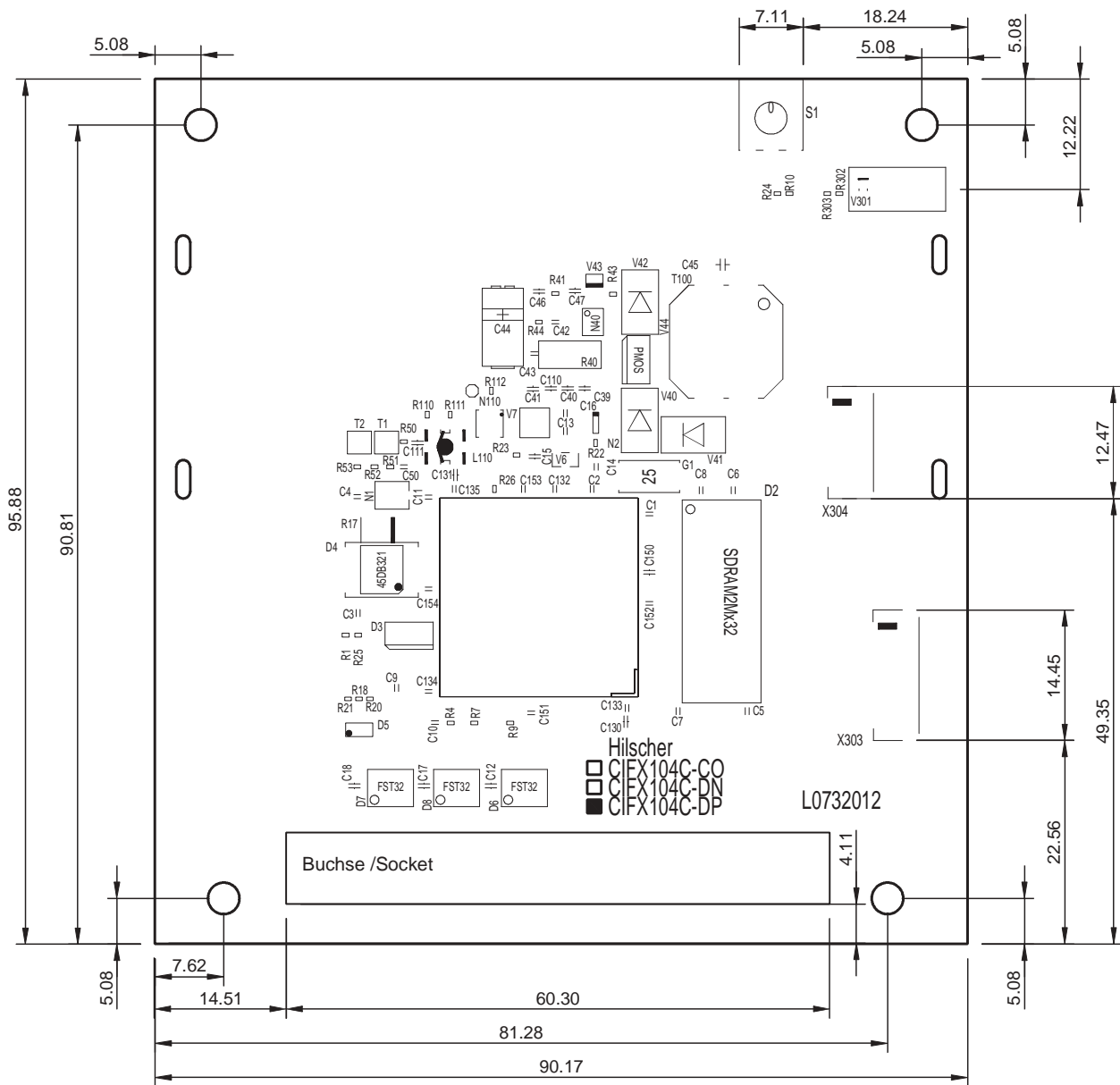

Figure 80: Dimensions CIFX 104C-FBIF

### 11.5.7 Reverse Side CIFX 104C-XX (all Basic Cards and Variants)

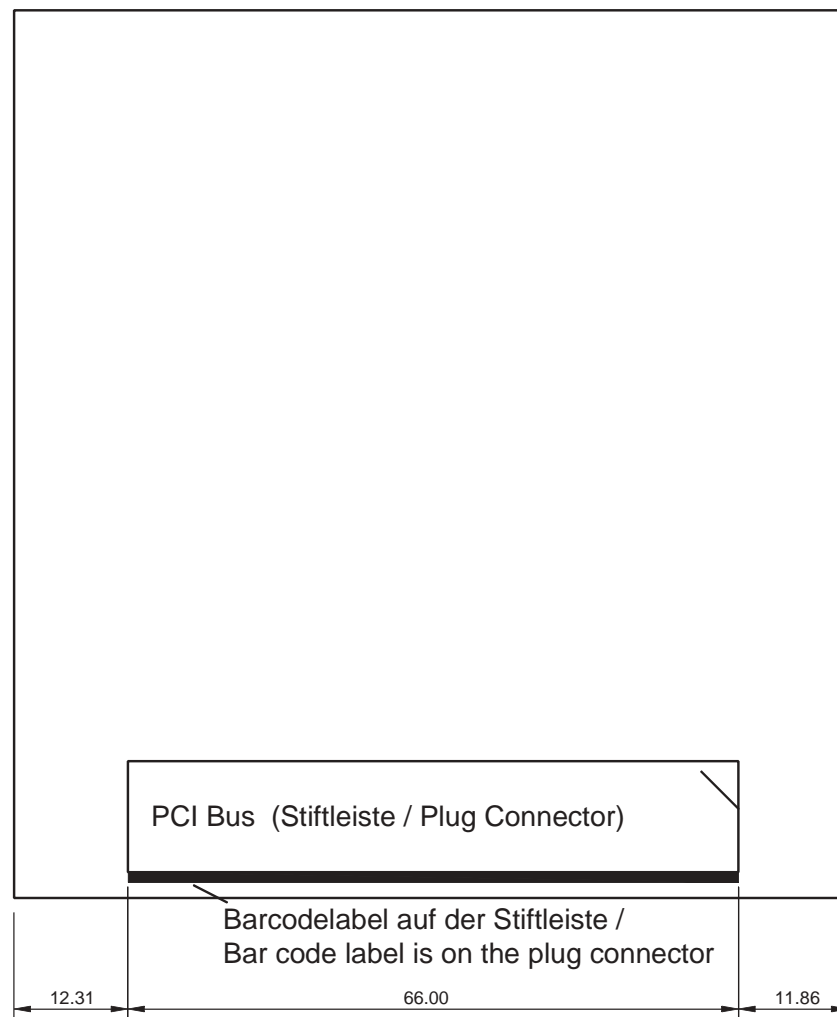

Figure 81: Reverse Side CIFX 104C-XX (all Basic Cards and Variants)

## 11.6 Dimensioning AIFX Assembly Interfaces

### 11.6.1 Ethernet - AIFX-RE

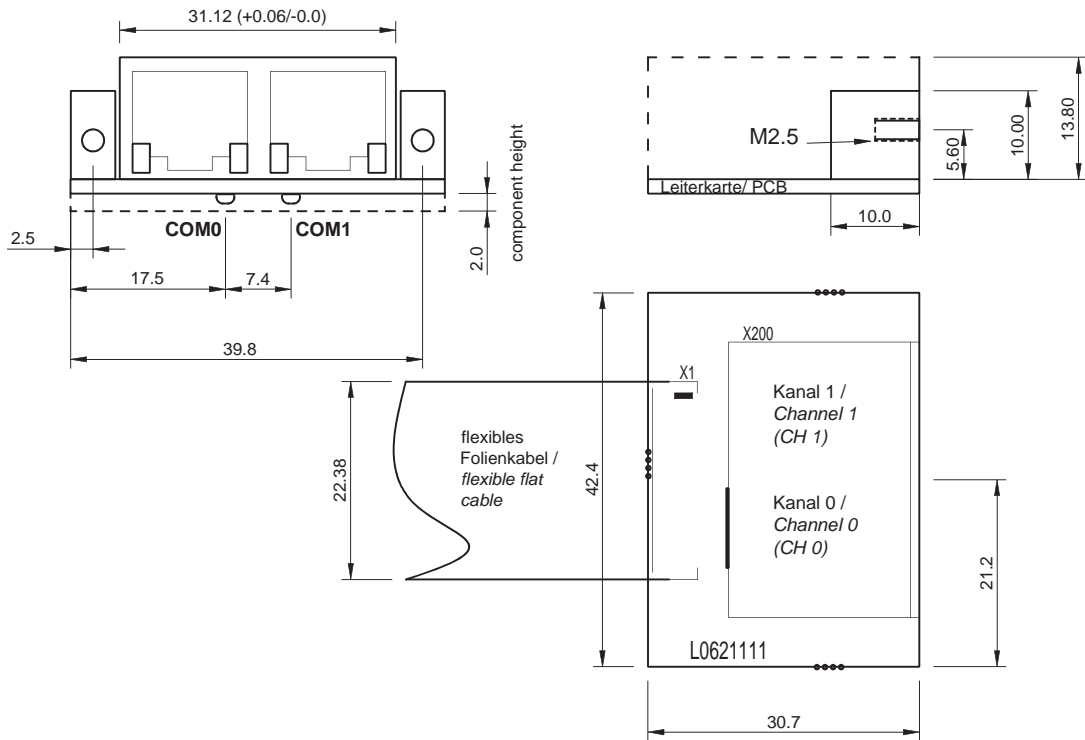

Figure 82: Dimensioning Ethernet Assembly Interface (AIFX-RE)

### 11.6.2 PROFIBUS - AIFX-DP

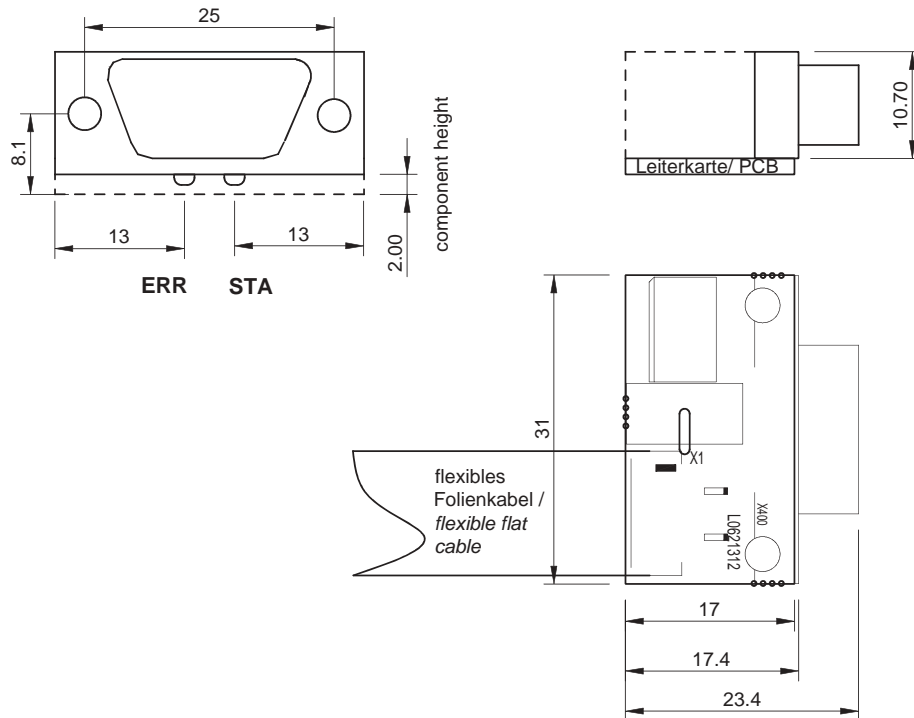

Figure 83: Dimensioning PROFIBUS Assembly Interface (AIFX-DP)

### 11.6.3 CANopen - AIFX-CO

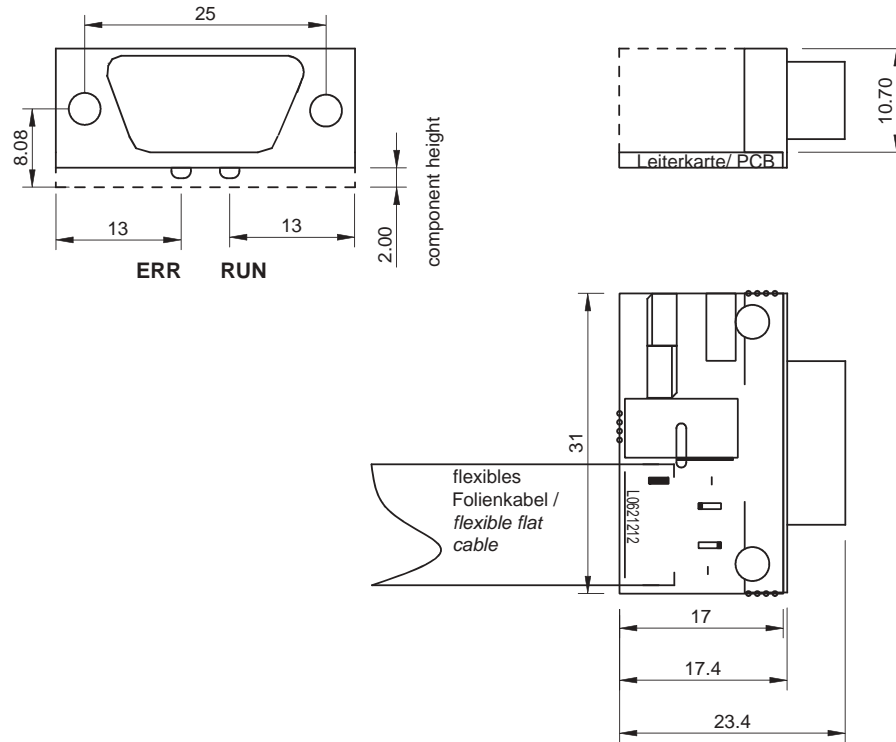

Figure 84: Dimensioning CANopen Assembly Interface (AIFX-CO)

### 11.6.4 DeviceNet - AIFX-DN

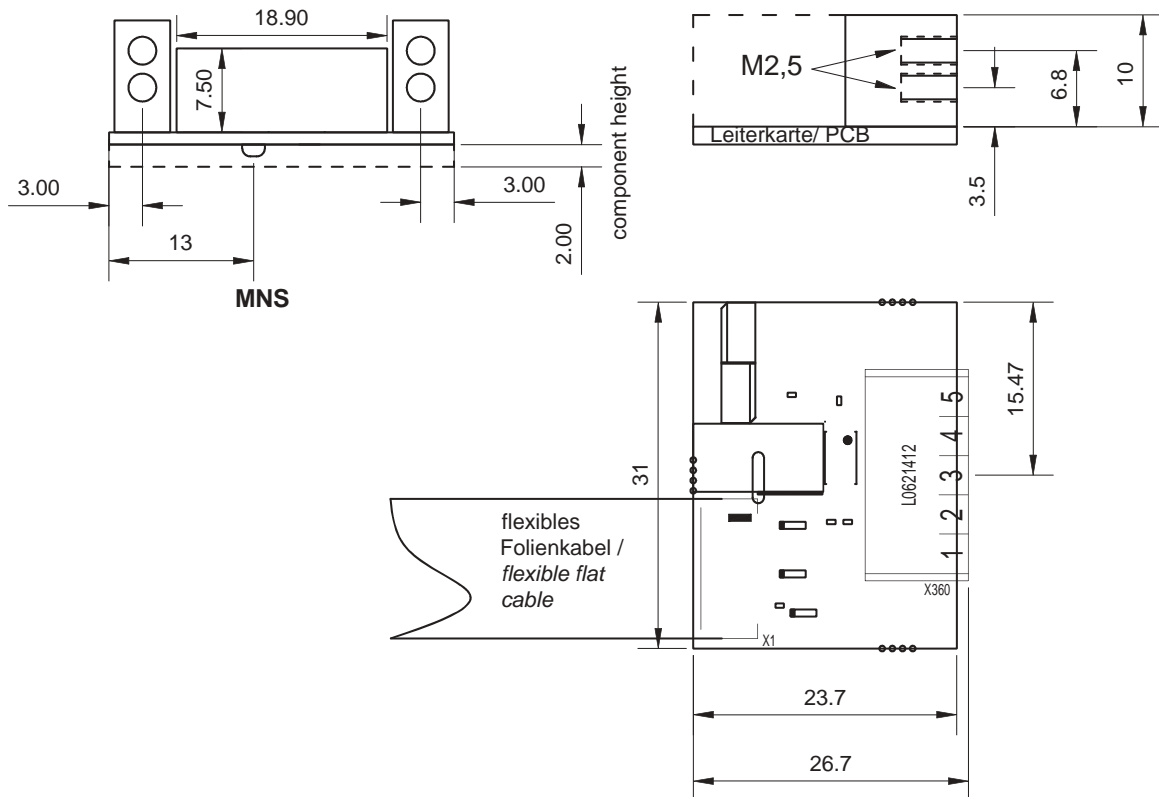

Figure 85: Dimensioning DeviceNet Assembly Interface (AIFX-DN)



### 11.6.5 CC-Link - AIFX-CC

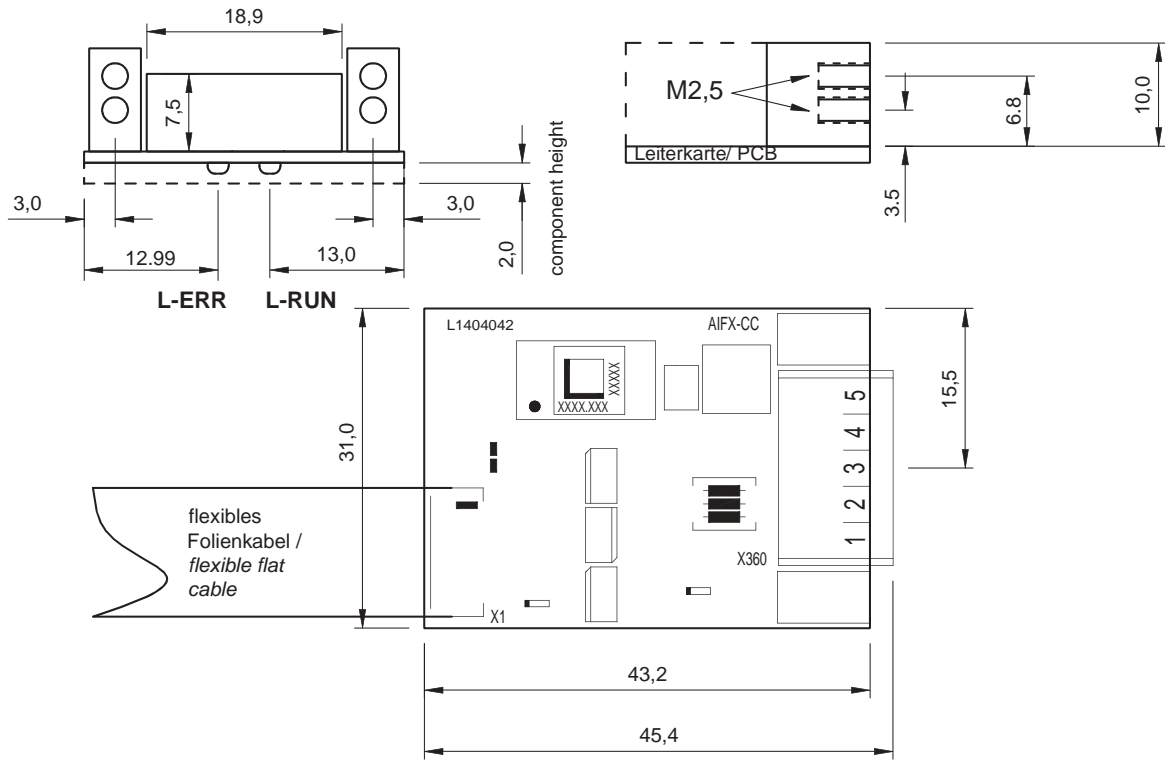

Figure 86: Dimensioning CC-Link Assembly Interface (AIFX-CC)

### 11.6.6 Diagnose - AIFX-DIAG

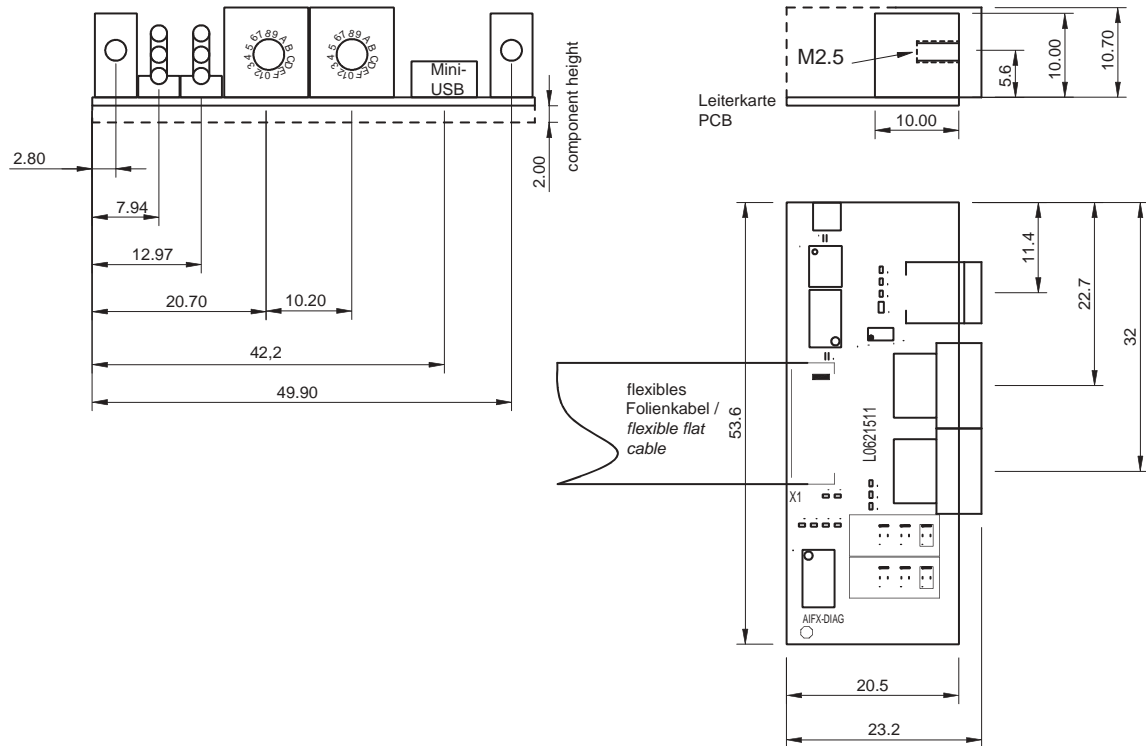

Figure 87: Dimensioning Diagnostic Assembly Interface (AIFX-DIAG)

## 11.7 Notes on earlier Hardware Revisions

### 11.7.1 Failure in 10 MBit/s Half Duplex Mode and Workaround

The note is only valid for the PC cards cifX up to serial numbers indicated:

PC Cars cifX	Part No	up to Serial Number
CIFX 80-RE	1280.100	20034
CIFX 90-RE\F	1290.100	20198
CIFX 90E-RE\F	1291.100	20311
CIFX 104C-RE	1270.100	20137
CIFX 104C-RE-R	1271.100	20029
CIFX 104C-RE\F	1270.101	20197
CIFX 104C-RE-R\F	1271.101	20071

#### NOTICE

#### Failure of the Network Communication

- Do not operate hardware with the communication controllers netX 50, netX100 or netX 500 with the protocols Ethernet TCP/UDP/IP, EtherNet/IP or Modbus TCP at 10 MBit/s in half-duplex mode, otherwise failure of the network communication can occur.
- Use only switches or 10/100 MBit/s dual-speed hubs and ensure that the network operates at 100 MBit/s and in full-duplex mode.

#### Affected Hardware

Hardware with the communication controller netX 50, netX 100 or netX 500; netX/Internal PHYs.

#### When can this Failure occur?

When using standard Ethernet communication with 10 MBit/s half duplex mode, the PHY gets stuck in case of network collisions. Then no further network communication is possible. Only device power cycling allows Ethernet communication again.

This problem can only occur with Ethernet TCP/UDP IP, EtherNet/IP or Modbus TCP protocols when using hubs at 10 MBit/s. The issue described above is not applicable for protocols which use 100 MBit/s or full duplex mode.

#### Solution / Workaround:

Do not use 10 MBit/s-only hubs. Use either switches or 10/100 MBit/s Dual Speed hubs, to make sure the netX Ethernet ports are connected with 100 MBit/s or in full duplex mode.

This erratum is fixed with all components of the 'Y' charge (9 digit charge number shows 'Y' at position 5 (nnnnYnnnn)).

#### Reference

"Summary of 10BT problem on EthernetPHY",  
RenesasElectronics Europe, April 27, 2010

## 11.7.2 Pin Assignment for Mini PCI Express Bus / SYNC Connector (Bootstart), X1/X2

The following details refer to the PC cards CIFX 90E-RE\F\*, CIFX 90E-DP\F, CIFX 90E-CO\F, CIFX 90E-DN\F of the earlier hardware revisions 5, 6, 7, 8 and A, as well as on the current hardware revision B (without the variants 'MR' or 'ET').

\*The SYNC connection is realized via the mini PCI Express bus.

Pin (X1)	Signal	Pin (X2)	Signal
51	(not used)	52	+3.3V
49	(not used)	50	GND
47	(not used)	48	(not used) (beginning from HW Rev. 6)
45	(not used)	46	IO_SYNC0 (not used with fieldbus protocols)
43	(not used)	44	IO_SYNC1 (not used with fieldbus protocols)
41	(not used)	42	Bootstart
39	(not used)	40	GND
37	(not used)	38	USB_D+ (beginning from HW Rev. B disabled – not used)
35	GND	36	USB_D- (beginning from HW Rev. B disabled – not used)
33	PERp0	34	GND
31	PERn0	32	(not used)
29	GND	30	(not used)
27	GND	28	(not used) (beginning from HW Rev. 6)
25	PETp0	26	GND
23	PETn0	24	(not used) (for HW Rev. ,6,7,8' + B)
21	GND	22	PERST#
19	(not used)	20	(not used)
17	(not used)	18	GND
15	GND	16	(not used)
13	REFCLK+	14	(not used)
11	REFCLK-	12	(not used)
9	GND	10	(not used)
7	CLKREQ#	8	(not used)
5	(not used)	6	(not used) (beginning from HW Rev. 6)
3	(not used)	4	GND
1	(not used)	2	3.3V

Table 174: Pin Assignment Mini PCI Express Bus / SYNC Connector, X1/X2

Unless otherwise noted, the pin assignment for Mini PCI Express bus, X1/X2 described in Table 115 corresponds to the bus specification for Mini PCI Express [bus spec 6, Rev. 1.2, Section 3.3].



**Note!** Please note the following characteristics for the pin assignment of the Mini PCI Express Bus, X1/X2, described in Table 115:

- The Pins 6, 28, 48 and Pin 24 are 'not used' (beginning from HW Rev. 6).
- The Pins 36 and 38 are 'not used' (beginning from HW Rev. B).
- The pin assignment of the Pins 42, 44, 46 deviates from the standard specification Mini PCI Express.



For the reference for [bus spec 6] for the bus specification for Mini PCI Express refer to section *References PCI Specifications* on page 133 of this manual.

**Pins 6, 28, 48**

- **Beginning from Hardware Revision 6:** For the hardware revisions of the PC cards CIFX 90E-RE\F, CIFX 90E-DP\F, CIFX 90E-CO\F and CIFX 90E-DN\F **beginning from Revision 6** the **Pins 6, 28, 48** are '**not used**', as listed in the *Table 115* on page 135.
- **Hardware Revisions 1 to 5:**



**Important!** For the hardware revisions **1 to 5** the **pins 6, 28, 48** may not be connected on the main board.

**Pin 24**

- **Hardware Revisions 6,7,8 + B:** For the hardware revisions **6,7,8 + B** of the PC cards CIFX 90E-RE\F, CIFX 90E-DP\F, CIFX 90E-CO\F and CIFX 90E-DN\F the **Pin 24** is '**not used**'.
- **Hardware Revisions 1 to 5 and A:** For the hardware revisions **1 to 5 and A** the **Pin 24** is used for **+3.3Vaux**, according to the bus specification for Mini PCI Express.

Pin (X2)	Signal	
	for HW Rev. 6,7,8 + B	for HW Rev. 1 to 5 and A
24	(not used)	+3.3Vaux
Usable with main boards according to Mini PCI Express specification [bus spec 6]	rev. <u>1.1</u> , <u>1.2</u> and <u>2.0</u>	rev. <u>1.2</u> and <u>2.0</u>

Table 175: Assignment of the Pin 24 for HW-Rev. 6,7,8 + B or 1 to 5 and A



**Note:** Due to how **pin 24** is used, the hardware revisions **6,7,8 + B** of the PC cards CIFX 90E-RE\F, CIFX 90E-DP\F, CIFX 90E-CO\F and CIFX 90E-DN\F can be used together with main boards according to any earlier revision as well as to the latest revision of the Mini PCI Express specification.

**Pins 36 and 38 (USB Connector)**

The USB connector at the Mini PCI Express Bus of the PC cards CIFX 90E-RE\F, CIFX 90E-DP\F, CIFX 90E-CO\F and CIFX 90E-DN\F is directly connected to the CPU of the PC and is not used for external diagnosis.

- **Hardware Revisions 1 to A:** When you start the PC, the operating system recognizes the USB port and asks for a driver.
- **Beginning of Hardware Revision B:** The Pins 36 and 38 are disabled and are '**not used**'. When you start the PC, the operating system does not ask for an USB driver.

**Pin 42 (Bootstart) and 44 , 46 (SYNC)**

- **Pin 42 (Bootstart):** For all PC cards CIFX 90E-RE\F, CIFX 90E-DP\F, CIFX 90E-CO\F and CIFX 90E-DN\F **pin 42** is used for **Bootstart**.
- **Pins 44 , 46 (SYNC):** For the PC cards CIFX 90E-RE\F depending by the protocol the **SYNC connection** is realized via the **pins 44 and 46** of the mini PCI Express bus. For further information to the SYNC pins (Pin 46, 44) refer to section *SYNC Connector (Pin-Assignment, Hardware/Firmware)* on page 131.

According to the bus specification for Mini PCI Express [bus spec 6] the pins are used to realize the LED status (Pin 42 „WWAN#“, Pin 44 „WLAN#“, Pin 46 „WPAN#“).

## 11.8 Disposal of Waste Electronic Equipment

According to the European Directive 2002/96/EG “Waste Electrical and Electronic Equipment (WEEE)”, waste electronic equipment may not be disposed of as household waste. As a consumer, you are legally obliged to dispose of all waste electronic equipment according to national and local regulations.



### Waste Electronic Equipment

- This product must not be treated as household waste.
- This product must be disposed of at a designated waste electronic equipment collecting point.

## 11.9 References

- [1] THE CIP NETWORKS LIBRARY, Volume 6, CompoNet Adaptation of CIP, Edition 1.4 November 2008
- [2] Data sheet MOD JACK – MJIM:  
<https://www.erni-x-press.com/de/downloads/zeichnungen/203313.pdf>
- [3] Design - Specification for VARAN Rev. 0.76, section 5.1.4 VARAN Splitter

References Protocol API Manuals
• CANopen Master Protocol API Manual, Revision 14, Hilscher GmbH 2013
• CANopen Slave Protocol API Manual (V3), Revision 5, Hilscher GmbH 2013
• DeviceNet Master Protocol API Manual, Revision 10, Hilscher GmbH 2013
• DeviceNet Slave Protocol API Manual, Revision 13, Hilscher GmbH 2013
• EtherCAT Master Protocol API Manual (V3), Revision 5, Hilscher GmbH 2013
• EtherCAT Slave Protocol API Manual, Revision 3 (V4), Hilscher GmbH 2013
• EtherCAT Slave Protocol API Manual, Revision 21 (V2), Hilscher GmbH 2013
• EtherNet/IP Scanner Protocol API Manual, Revision 13, Hilscher GmbH 2013
• EtherNet/IP Adapter Protocol API Manual, Revision 12, Hilscher GmbH 2013
• Open Modbus/TCP Protocol API Manual, Revision 8, Hilscher GmbH 2013
• POWERLINK Controlled Node/Slave Protocol API Manual, Revision 12, Hilscher GmbH 2013
• PROFIBUS DP Master Protocol API Manual, Revision 18, Hilscher GmbH 2013
• PROFIBUS DP Slave Protocol API Manual, Revision 15, Hilscher GmbH 2013
• PROFIBUS MPI Protocol API Manual, Revision 4, Hilscher GmbH 2011
• PROFINET IO-Controller Protocol API Manual, Revision 18, Hilscher GmbH 2013
• PROFINET IO-Device Protocol API Manual (V3.4), Revision 13, Hilscher GmbH 2013
• PROFINET IO-Device Protocol API Manual (V3.5), Revision 6, Hilscher GmbH 2013
• sercos Master Protocol API Manual, Revision 11, Hilscher GmbH 2013
• sercos Slave Protocol API Manual (V3), Revision 12, Hilscher GmbH 2013
• VARAN Client Protocol API Manual, Revision 3, Hilscher GmbH 2013

Table 176: References Protocol API Manuals

References referring to the safety issues are listed separately in section *References Safety* on page 29.

References referring to the Standard Bus Specifications for Compact PCI, Mini PCI, Mini PCI Express and PCI-104 are listed separately *References PCI Specifications* on page 133.

## 11.10 EtherCAT Summary over Vendor ID, Conformance test, Membership and Network Logo

### 11.10.1 Vendor ID

The communication interface product is shipped with Hilscher's secondary vendor ID, which has to be replaced by the Vendor ID of the company shipping end products with the integrated communication interface. End Users or Integrators may use the communication interface product without further modification if they re-distribute the interface product (e.g. PCI Interface card products) only as part of a machine or machine line or as spare part for such a machine. In case of questions, contact Hilscher and/or your nearest ETG representative. The ETG Vendor-ID policies apply.

### 11.10.2 Conformance

EtherCAT Devices have to conform to the EtherCAT specifications. The EtherCAT Conformance Test Policies apply, which can be obtained from the EtherCAT Technology Group (ETG, [www.ethercat.org](http://www.ethercat.org)).

Hilscher range of embedded network interface products are conformance tested for network compliance. This simplifies conformance testing of the end product and can be used as a reference for the end product as a statement of network conformance (when used with standard operational settings). It must however be clearly stated in the product documentation that this applies to the network interface and not to the complete product.

Conformance Certificates can be obtained by passing the conformance test in an official EtherCAT Conformance Test lab. Conformance Certificates are not mandatory, but may be required by the end user.

### 11.10.3 Certified Product vs. Certified Network Interface

The EtherCAT implementation may in certain cases allow one to modify the behavior of the EtherCAT network interface device in ways which are not in line with EtherCAT conformance requirements. For example, certain communication parameters are set by a software stack, in which case the actual software implementation in the device application determines whether or not the network interface can pass the EtherCAT conformance test. In such cases, conformance test of the end product must be passed to ensure that the implementation does not affect network compliance.

Generally, implementations of this kind require in-depth knowledge in the operating fundamentals of EtherCAT. To find out whether or not a certain type of implementation can pass conformance testing and requires such testing, contact EtherCAT Technology Group ("ETG", [www.ethercat.org](http://www.ethercat.org)) and/or your nearest EtherCAT conformance test centre. EtherCAT may allow the combination of an untested end product with a conformant network interface. Although this may in some cases make it possible to sell the end product without having to perform network conformance tests, this approach is generally not endorsed by Hilscher. In case of questions, contact Hilscher and/or your nearest ETG representative.

### 11.10.4 Membership and Network Logo

Generally, membership in the network organization and a valid Vendor-ID are prerequisites in order to be able to test the end product for conformance. This also applies to the use of the EtherCAT name and logo, which is covered by the ETG marking rules.

*Vendor ID Policy accepted by ETG Board of Directors, November 5, 2008*

## 11.11 List of Figures

Figure 1: System Overview cifX to update Firmware, Driver and Software	57
Figure 2: CIFX 80-RE*	58
Figure 3: Front Plate CIFX 80-RE	58
Figure 4: CIFX 80-DP	59
Figure 5: Front Plate CIFX 80-RE	59
Figure 6: CIFX 80-CO	60
Figure 7: Front Plate CIFX 80-CO	60
Figure 8: CIFX 80-DN	61
Figure 9: Front Plate CIFX 80-DN	61
Figure 10: Basic Card CIFX 90 for CIFX 90-RE\F*	62
Figure 11: Basic Card CIFX 90E (for CIFX 90E-RE\F) respectively equally looking basic Card CIFX 90E\ET (for CIFX 90E-RE\ET\F*)	62
Figure 12: Basic Card CIFX 90E\MR for (CIFX 90E-RE\MR\F) respectively equally looking basic Card CIFX 90E\MR\ET (for CIFX 90E-RE\MR\ET\F*)	62
Figure 13: Basic Card CIFX 90 for CIFX 90-DP\F, CIFX 90-CO\F, CIFX 90-DN\F	63
Figure 14: Basic Card CIFX 90E (for CIFX 90E-FB\F) respectively equally looking basic Card CIFX 90E\ET (for CIFX 90E-FB\ET\F)	63
Figure 15: Basic Card CIFX 90E\MR for (CIFX 90E-FB\MR\F) respectively equally looking basic Card CIFX 90E\MR\ET (for CIFX 90E-FB\MR\ET\F)	63
Figure 16: Basic Card CIFX 90E-2FB\ET for CIFX 90E-2FB\ET\F	64
Figure 17: Basic Card CIFX 90E-2FB\MR\ET for CIFX 90E-2FB\MR\ET\F	64
Figure 18: Reverse Side CIFX 90-XX\F	64
Figure 19: Reverse Side CIFX 90E-XX\F	64
Figure 20: CIFX 104C-RE*	65
Figure 21: CIFX 104C-RE-R*	65
Figure 22: Basic Card for CIFX 104C-RE\F	66
Figure 23: Basic Card for CIFX 104C-RE-R\F	66
Figure 24: CIFX 104C-DP	67
Figure 25: CIFX 104C-DP-R	67
Figure 26: CIFX 104C-CO	68
Figure 27: CIFX 104C-CO-R	68
Figure 28: CIFX 104C-DN	69
Figure 29: CIFX 104C-DN-R	69
Figure 30: Basic Card CIFX 104C-FB\F for CIFX 104C-DP\F, CIFX 104C-CO\F, CIFX 104C-DN\F, CIFX 104C-CC\F	70
Figure 31: Basic Card CIFX 104C-FB-R\F for CIFX 104C-DP-R\F, CIFX 104C-CO-R\F, CIFX 104C-DN-R\F	70
Figure 32: Reverse Side CIFX 104C-XX (all Basic Cards and Variants)	71
Figure 33: Ethernet Assembly Interface (AIFX-RE)*	72
Figure 34: Front Side and LED Display Ethernet Assembly Interface (AIFX-RE)	72
Figure 35: PROFIBUS Assembly Interface (AIFX-DP)	73
Figure 36: Front Side and LED Display PROFIBUS Assembly Interface (AIFX-DP)	73
Figure 37: CANopen Assembly Interface (AIFX-CO)	74
Figure 38: Front Side and LED Display Assembly Interface (AIFX-CO)	74
Figure 39: DeviceNet Assembly Interface (AIFX-DN)	75
Figure 40: Front Side and LED Display DeviceNet Assembly Interface (AIFX-DN)	75
Figure 41: CC-Link Assembly Interface (AIFX-CC)	76
Figure 42: Reverse Side CC-Link Assembly Interface (AIFX-CC) with Matrix Label	76
Figure 43: Front Side and LED Display CC-Link Assembly Interface (AIFX-CC)	76
Figure 44: Diagnostic Assembly Interface (AIFX-DIAG)	77
Figure 45: Front Side, LED Display and Reverse Side Diagnostic Assembly Interface (AIFX-DIAG)	77
Figure 46: Front Plate Stickers for CIFX 80-RE	81

Figure 47: Mounting the Basic Card CIFX 90E into the PCI Express Mini System Connector	84
Figure 48: Connecting the Ethernet Assembly Interface (AIFX-RE) to the basic Card CIFX 90E (Example)	85
Figure 49: Connecting the CANopen Assembly Interface (AIFX-CO) to the basic Card CIFX 90E (Example)	85
Figure 50: PC Cards cifX Mini PCI Express with 2 Channels: How to connect the Assembly Interfaces to the Basic Card (Example CIFX 90E-2FB\ET)	86
Figure 51: Demounting the Basic Card CIFX 90E from the PCI Express Mini System Connector (Example: Basic Card CIFX 90E)	88
Figure 52: Connecting the Ethernet Assembly Interface (AIFX-RE) to the Basic Card CIFX 104C-RE\F (Example)	90
Figure 53: Connecting the CANopen Assembly Interface (AIFX-CO) to the Basic Card 104C-FB-R\F (Example)	90
Figure 54: Connecting the Diagnostic Assembly Interface (AIFX-DIAG) to the Basic Card CIFX 104C-FB-R\F (Example)	91
Figure 55: Ethernet Pin Assignment at the RJ45 Socket for cifX or AIFX	123
Figure 56: PROFIBUS Interface (DSub female connector, 9 pin), X400	125
Figure 57: CANopen Interface (DSub male connector, 9 pin), X400	125
Figure 58: DeviceNet Interface (CombiCon male Connector, 5 pin), X360	126
Figure 59: CC-Link Interface (CombiCon male Connector, 5 pin)	126
Figure 60: Mini-B USB Connector (5 Pin)	127
Figure 61: 1x20 Pins for CIFX 104C-RE\F, CIFX 104C-RE-R\F, CIFX 90-RE\F or CIFX 90-RE\ET\F	128
Figure 62: 2x20 Pins for CIFX 90E-RE\F, CIFX 90E-RE\ET\F, CIFX 90E-RE\MR\F or CIFX 90E-RE\MR\ET\F	128
Figure 63: Example 2D Label (mini sticker on the right)	217
Figure 64: Example Barcode Label (EAN 39)	217
Figure 65: Dimensions CIFX 80E-RE	219
Figure 66: Dimensions Front Panel for CIFX 80-RE	219
Figure 67: Dimensions CIFX 80-DP	220
Figure 68: Front Panel for CIFX 80-DP	220
Figure 69: Dimensions CIFX 80-CO	221
Figure 70: Dimensions Front Panel for CIFX 80-CO	221
Figure 71: Dimensions CIFX 80-DN	222
Figure 72: Dimensions Front Panel CIFX 80-DN	222
Figure 73: Dimensions CIFX 90-XX\F and Variants	223
Figure 74: Dimensions CIFX 90E-XX\F and Variants	223
Figure 75: Dimensions CIFX 104C-RE	224
Figure 76: Dimensions CIFX 104C-RE\F	225
Figure 77: Dimensions CIFX 104C-DP	226
Figure 78: Dimensions CIFX 104C-CO	227
Figure 79: Dimensions CIFX 104C-DN	228
Figure 80: Dimensions CIFX 104C-FB\F	229
Figure 81: Reverse Side CIFX 104C-XX (all Basic Cards and Variants)	230
Figure 82: Dimensioning Ethernet Assembly Interface (AIFX-RE)	231
Figure 83: Dimensioning PROFIBUS Assembly Interface (AIFX-DP)	231
Figure 84: Dimensioning CANopen Assembly Interface (AIFX-CO)	232
Figure 85: Dimensioning DeviceNet Assembly Interface (AIFX-DN)	232
Figure 86: Dimensioning CC-Link Assembly Interface (AIFX-CC)	233
Figure 87: Dimensioning Diagnostic Assembly Interface (AIFX-DIAG)	233

## 11.12 List of Tables

Table 1: List of Revisions	10
----------------------------	----



Table 2: Reference on Hardware PC Cards cifX, AIFX Assembly Interfaces	12
Table 3: Reference on Firmware (for 1 Channel Systems)	12
Table 4: Reference on Firmware (for 2 Channel Systems)	13
Table 5: Reference on Driver and Software	13
Table 6: PROFINET IO-Device Firmware Version 3.4 and 3.5, Header, GSDML and Protocol API Manual	16
Table 7: EtherCAT-Slave Firmware Version 2.5 and 4.2, Header, XML and Protocol API Manual	17
Table 8: Device Description Files for PC Cards cifX Real-Time-Ethernet	18
Table 9: Device Description Files for PC Cards cifX Fieldbus	19
Table 10: PC Cards cifX and the Real-Time Ethernet or Fieldbus Systems realizable	24
Table 11: PC Cards cifX with AIFX Assembly Interface	25
Table 12: Signal Words and Safety Signs in Safety Messages on Personal Injury	29
Table 13: Signal Words and Safety Signs in Safety Messages on Property Damage	29
Table 14: PC Cards Compact PCI CIFX 80-XX	31
Table 15: PC Cards PCI-104: CIFX 104C-XX and CIFX 104C-XX-R	31
Table 16: PC Cards Mini PCI CIFX 90-XX\	33
Table 17: PC Cards Mini PCI Express CIFX 90E-XX\F	33
Table 18: PC Cards Mini PCI Express CIFX 90E-XX\ET\F	34
Table 19: PC Cards Mini PCI Express (2 Channels) CIFX 90E-2XX\ET\F, CIFX 90E-2XX\XX\ET\F	35
Table 20: PC Cards Mini PCI Express CIFX 90E-XX\MR\F	36
Table 21: PC Cards Mini PCI Express CIFX 90E-XX\MR\ET\F	37
Table 22: PC Cards Mini PCI Express (2 Channels) CIFX 90E-2XX\MR\ET\F, CIFX 90E-2XX\XX\MR\ET\F	38
Table 23: PC Cards PCI-104: CIFX 104C-XX\F and CIFX 104C-XX-R\F	39
Table 24: AIFX Assembly Interfaces for PC Cards cifX with Cable Connector	40
Table 25: Firmware Versions for the DMA Mode	41
Table 26: Firmware Versions for the DMA Mode (for 2 Channel Systems)	42
Table 27: Versions Driver and SYCON.net for the DMA Mode	42
Table 28: Slot for the PC Cards cifX Compact PCI, Mini PCI, Mini PCIe, Mini PCIe (2 channel), PCI-104	43
Table 29: Notes on the Card Height - PC Card cifX Mini PCI and Mini PCI Express	44
Table 30: Panel Cutout at the at the Housing Panel of the PC or at the front plate of the PC cabinet	45
Table 31: Required Panel Cutout and Holes for AIFX	46
Table 32: Requirements Power Supply and Host Interface for PC Cards cifX Compact PCI, Mini PCI, Mini PCI Express and PCI-104	47
Table 33: Requirements to operate PC Cards cifX properly	48
Table 34: Steps for the Software and Hardware Installation, the Configuration and for the Diagnosis of a PC Card cifX Compact PCI, Mini PCI, Mini PCI Express and PCI-104 (Master and Slave)	53
Table 35: Notes for the Configuration of the Master Device	55
Table 36: Device Names in SYCON.net by Communication Protocol	56
Table 37: LED Labeling depending of the loaded Firmware	81
Table 38: How to assign the Assembly Interfaces for 2-Channel Cards cifX Mini PCI Express	86
Table 39: Overview LEDs Real-Time Ethernet Systems	94
Table 40: LED Names	94
Table 41: Overview LEDs by Fieldbus System for 1 Channel Devices	95
Table 42: Overview LEDs by Fieldbus System for 2 Channel Devices (only PC Cards cifX Mini PCI Express)	95
Table 43: LED Names	95
Table 44: System Status LED States	96
Table 45: System Status LED State Definitions	96
Table 46: Power On LED States	96
Table 47: Power On LED state definitions	96
Table 48: LED states for the EtherCAT Master protocol	97
Table 49: LED state definitions for the EtherCAT Master protocol	97
Table 50: LED states for the EtherCAT Slave protocol	98
Table 51: LED state definitions for the EtherCAT Slave protocol	98
Table 52: LED states for the EtherNet/IP Scanner protocol	99

Table 53: LED state definitions for the EtherNet/IP Scanner protocol	99
Table 54: LED states for the EtherNet/IP Adapter protocol	100
Table 55: LED state definitions for the EtherNet/IP Adapter protocol	100
Table 56: LED states for the OpenModbusTCP protocol	101
Table 57: LED state definitions for the OpenModbusTCP protocol	101
Table 58: LED states for the POWERLINK Controlled Node protocol	102
Table 59: LED state definitions for the POWERLINK Controlled Node protocol	102
Table 60: LED states for the PROFINET IO-Controller protocol	103
Table 61: LED state definitions for the PROFINET IO-Controller protocol	103
Table 62: LED states for the PROFINET IO-Device protocol	104
Table 63: LED state definitions for the PROFINET IO-Device protocol	104
Table 64: LED states for the sercos Master protocol	105
Table 65: LED state definitions for the sercos Master protocol	106
Table 66: LED state definitions for the sercos Slave protocol	107
Table 67: LED state definitions for the sercos Slave protocol	108
Table 68: LED-Zustände für das VARAN-Client-Protokoll	109
Table 69: Definitionen der LED-Zustände für das VARAN-Client-Protokoll	109
Table 70: LED states for the PROFIBUS DP Master protocol – 1 Communication Status LED (current Hardware Revision)	110
Table 71: LED state definitions for the PROFIBUS DP Master protocol	110
Table 72: LED states for the PROFIBUS DP Master protocol – 2 Communication Status LEDs (AIFX-DP connected or prior Hardware Revision)	111
Table 73: LED state definitions for the PROFIBUS DP Master protocol	111
Table 74: LED states for the PROFIBUS DP Slave protocol – 1 Communication Status LED (current Hardware Revision)	112
Table 75: LED state definitions for the PROFIBUS DP Slave protocol	112
Table 76: LED states for the PROFIBUS DP Slave protocol – 2 Communication Status LEDs (AIFX-DP connected or prior Hardware Revision)	113
Table 77: LED state definitions for the PROFIBUS DP Slave protocol	113
Table 78: LED states for the PROFIBUS MPI protocol – 1 Communication Status LED	114
Table 79: LED state definitions for the PROFIBUS MPI protocol	114
Table 80: LED states for the PROFIBUS MPI protocol – 2 Communication Status LEDs (AIFX-DP connected)	115
Table 81: LED state definitions for the PROFIBUS MPI protocol	115
Table 82: LED states for the CANopen Master protocol – 1 Communication Status LED (current Hardware Revision)	116
Table 83: LED state definitions for the CANopen Master protocol	116
Table 84: LED states for the CANopen Master protocol – 2 Communication Status LEDs (AIFX-CO connected or prior Hardware Revision)	117
Table 85: LED state definitions for the CANopen Master protocol	117
Table 86: States of the CAN LED for the CANopen Slave protocol – 1 Communication Status LED (current Hardware Revision)	118
Table 87: LED state definitions for the CANopen Slave protocol	118
Table 88: States of the CAN LED for the CANopen Slave protocol – 2 Communication Status LEDs (AIFX-CO connected or prior Hardware Revision)	119
Table 89: LED state definitions for the CANopen Slave protocol	119
Table 90: LED states for the DeviceNet Master protocol	120
Table 91: LED state definitions for the DeviceNet Master protocol	120
Table 92: LED states for the DeviceNet Slave protocol	121
Table 93: LED state definitions for the DeviceNet Slave protocol	121
Table 94: LED states for the CC-Link Slave protocol	122
Table 95: LED state definitions for the CC-Link Slave protocol	122
Table 96: Ethernet Pin Assignment at the RJ45 Socket for cifX or AIFX	123
Table 97: Ethernet Connection Data	124
Table 98: Use of Hubs and Switches	124

Table 99: PROFIBUS Interface, X400	125
Table 100: CANopen Interface, X400	125
Table 101: DeviceNet Interface, X360	126
Table 102: CC-Link Interface	126
Table 103: Pin Assignment Mini-B USB Connector	127
Table 104: Rotary Switch for PCI-104 Slot Number, S1	127
Table 105: Pin Assignment for Cable Connector Ethernet X4 or X304	128
Table 106: Pin Assignment for Cable Connector Fieldbus X3, X304 or X4	129
Table 107: Pin Assignment for Cable Connector Fieldbus X3 and X4 for 2 Channel Devices	129
Table 108: Pin Assignment for Cable connector DIAG X3 or X303	130
Table 109: Pin Assignment for SYNC Connector, X51	131
Table 110: SYNC Connector: SYNC Signal, Connector, Max. Cable Length	131
Table 111: Meaning of the SYNC Signals for each Protocol	131
Table 112: Pin Assignment at the PCI Bus	132
Table 113: References PCI Specifications	133
Table 114: Pin Assignment for Mini PCI Bus, X1	134
Table 115: Pin Assignment Mini PCI Express Bus / SYNC Connector, X1/X2	135
Table 116: Pin Assignment Mini PCI Express Bus, X1/X2 for 2 Channel Devices	137
Table 117: Technical Data CIFX 80-RE	141
Table 118: Technical Data CIFX 80-DP	142
Table 119: Technical Data CIFX 80-CO	143
Table 120: Technical Data CIFX 80-DN	145
Table 121: Technical Data CIFX 90-RE\F	147
Table 122: Technical Data CIFX 90-DP\F	148
Table 123: Technical Data CIFX 90-CO\F	150
Table 124: Technical Data CIFX 90-DN\F	151
Table 125: Technical Data CIFX 90-CC\F	152
Table 126: Technical Data CIFX 90E-RE\F, CIFX 90E-RE\ET\F, CIFX 90E-RE\MR\F, CIFX 90E-RE\MR\ET\F	155
Table 127: Technical Data CIFX 90E-DP\F, CIFX 90E-DP\ET\F, CIFX 90E-DP\MR\F, CIFX 90E-DP\MR\ET\F	157
Table 128: Technical Data CIFX 90E-CO\F, CIFX 90E-CO\ET\F, CIFX 90E-CO\MR\F, CIFX 90E-CO\MR\ET\F	159
Table 129: Technical Data CIFX 90E-DN\F, CIFX 90E-DN\ET\F, CIFX 90E-DN\MR\F, CIFX 90E-DN\MR\ET\F	161
Table 130: Technical Data CIFX 90E-CC\ET\F, CIFX 90E-CC\MR\ET\F	163
Table 131: Technical Data CIFX 90E-2DP\ET\F, CIFX 90E-2DP\MR\ET\F	165
Table 132: Technical Data CIFX 90E-2DP\CO\ET\F, CIFX 90E-2DP\CO\MR\ET\F	167
Table 133: Technical Data CIFX 90E-2DP\DN\ET\F, CIFX 90E-2DP\DN\MR\ET\F	169
Table 134: Technical Data CIFX 90E-2CO\ET\F, CIFX 90E-2CO\MR\ET\F	171
Table 135: Technical Data CIFX 90E-2CO\DN\ET\F, CIFX 90E-2CO\DN\MR\ET\F	173
Table 136: Technical Data CIFX 90E-2DN\ET\F, CIFX 90E-2DN\MR\ET\F	174
Table 137: Technical Data CIFX 104C-RE, CIFX 104C-RE-R	177
Table 138: Technical Data CIFX 104C-RE\F, CIFX 104C-RE-R\F	179
Table 139: Technical Data CIFX 104C-DP, CIFX 104C-DP-R	180
Table 140: Technical Data CIFX 104C-DP\F, CIFX 104C-DP-R\F	182
Table 141: Technical Data CIFX 104C-CO, CIFX 104C-CO-R	183
Table 142: Technical Data CIFX 104C-CO\F, CIFX 104C-CO-R\F	185
Table 143: Technical Data CIFX 104C-DN, CIFX 104C-DN-R	187
Table 144: Technical Data CIFX104C-DN\F, CIFX 104C-DN-R\F	188
Table 145: Technical Data CIFX104C-CC\F	190
Table 146: Technical Data AIFX-RE	191
Table 147: Technical Data AIFX-DP	192
Table 148: Technical Data AIFX-CO	193

Table 149: Technical Data AIFX-DN	194
Table 150: Technical Data AIFX-CC	195
Table 151: Technical Data AIFX-DIAG	196
Table 152: PCI IDs PC Cards cifX on the PCI Bus	197
Table 153: Supported / not supported PCI Bus Commands	197
Table 154: Technical Data EtherCAT Master Protocol	198
Table 155: Technical Data EtherCAT Slave Protocol	199
Table 156: Technical Data EtherNet/IP Scanner (Master) Protocol	200
Table 157: Technical Data EtherNet/IP Adapter (Slave) Protocol	201
Table 158: Technical Data Open Modbus/TCP Protocol	202
Table 159: Technical Data POWERLINK Controlled Node (Slave) Protocol	202
Table 160: Technical Data PROFINET IO RT Controller	204
Table 161: Technical Data PROFINET IO RT IRT Device Protocol	204
Table 162: Technical Data PROFINET IO RT IRT Device Protocol	205
Table 163: Technical Data sercos Master Protocol	206
Table 164: Technical Data sercos Slave Protocol	207
Table 165: Technical Data VARAN Client Protocol	208
Table 166: Technical Data PROFIBUS DP Master Protocol	209
Table 167: Technical Data PROFIBUS DP Slave Protocol	210
Table 168: Technical Data PROFIBUS-MPI Protocol	211
Table 169: Technical Data CANopen Master Protocol	212
Table 170: Technical Data CANopen Slave Protocol	213
Table 171: Technical Data DeviceNet Master Protocol	214
Table 172: Technical Data DeviceNet Slave Protocol	215
Table 173: Technical Data CC-Link-Slave Protocol	216
Table 174: Pin Assignment Mini PCI Express Bus / SYNC Connector, X1/X2	235
Table 175: Assignment of the Pin 24 for HW-Rev. 6,7,8 + B or 1 to 5 and A	236
Table 176: References Protocol API Manuals	237

## 11.13 Glossary

### 10-Base T

Standard for communication on Ethernet over twisted pair lines with RJ45 connectors and a [Baud rate](#) of 10 MBit/s (according to the IEEE 802.3 specification).

### 100-Base TX

Standard for communication on Ethernet over unshielded twisted pair lines with RJ45 connectors and a baud rate of 100 MBit/s according to the IEEE 802. specification

### AIFX

**Assembly InterFace based on netX**

### Auto-Crossover

Auto-Crossover is a feature of an interface: An interface with Auto-Crossover capability will automatically detect and correct if the data lines have been exchanged vice versa.

## Auto-Negotiation

Auto-Negotiation is a feature of an interface: An interface with Auto-Negotiation will automatically determine a set of correct communication parameters.

## Baud rate

Data transmission speed of a communication channel or interface.

## Boot loader

Program loading the firmware into the memory of a device in order to be executed.

## Ch0, Ch1 ...

Within the configuration software SYCON.net the communication channels are named ,Ch0', Ch1' ....

For the Real-Time-Ethernet devices cifX, comX and netJACK and the Real-Time Ethernet protocols used with it, the following shall apply:

**'Ch0' in SYCON.net:** Both ports of the Ethernet RJ45 connector CH0 and CH1 are assigned always to channel 0 in SYCON.net.

**'Ch1' in SYCON.net:** Depending on the firmware channel 1 in SYCON.net can be used as an additional communication channel.

## CH0, CH1 (Ch0, Ch1)

Names for the ports of an Ethernet RJ45 socket with two Ethernet channels.

CH0 stands for Ethernet channel 0.

CH1 stands for Ethernet channel 1.

## cifX

Communication InterFace based on netX

## cifX TCP/IP Server

*cifX TCP Server.exe*

Program for the remote diagnostics via Ethernet.

Name: **cifX TCP/IP Server for SYCON.net**

User Interface: **TCP/IP Server for cifX**

## Coil

A coil is a single bit in the memory that can be accessed using Modbus: read or write access with FC 1, 5, 15. Depending on the used Modbus function code a single coil or several coils lying in succession can be accessed.

## CSP

electronic device data sheet, required for each CC-Link device

---

**Device Description File**

A file containing configuration information about a device being a part of a network that can be read out by masters for system configuration. Device Description Files use various formats which depend on the communication system.

**DHCP**

Dynamic Host Configuration Protocol

This is a protocol simplifying the configuration of IP networks by automatically assigning IP addresses.

**Discrete Input**

A "Discrete Input" (as defined in the Modbus terminology) is a single bit in the memory which can be accessed using Modbus (read with FC 2).

**DP**

Decentral Periphery

**DPM**

Dual-Port Memory

**EDS**

Electronic Data Sheet

**EDS file**

A special kind of Device Description File used for example by EtherNet/IP.

**ET**

Extended Temperature Range (Operating Temperature)

PC cards cifX with the addition of "ET" at the end of the part name can be used in an extended operating temperature range. Details to the operating temperature range are given in the technical data to the respective card.

**EtherCAT**

A communication system for industrial Ethernet designed and developed by Beckhoff Automation GmbH.

**Ethernet**

A networking technology used both for office and industrial communication via electrical or optical connections. It has been developed and specified by the Intel, DEC and XEROX. It provides data transmission with collision control and allows various protocols. As Ethernet is not necessarily capable for real-time application, various real-time extensions have been developed.

**EtherNet/IP**

A communication system for industrial Ethernet designed and developed by Rockwell. It partly uses the CIP (Common Industrial Protocol).

**EtherNet/IP Scanner**

A Scanner exchanges real-time I/O data with Adapters and Scanners. This type of node can respond to connection requests and can also initiate connections on its own.

**EtherNet/IP Adapter**

An Adapter emulates functions provided by traditional rack-adapter products. This type of node exchanges real-time I/O data with a Scanner Class product. It does not initiate connections on its own.

**Ethernet POWERLINK**

A communication system for industrial Ethernet designed and developed by B&R. It partly uses CANopen technologies.

**FDL**

Fieldbus Data Link defines the PROFIBUS communication on layer 2, identical for DP and FMS

**Firmware**

Software running inside a device providing the basic functionality of this device. It can be updated by a firmware download.

**Full duplex**

Full duplex denominates a telecommunication system between two communication partners which allows simultaneous communication in both directions is called a full-duplex telecommunication system. At such a system, it will be possible to transmit data even if currently data are received. Full-duplex is the opposite of Half\_duplex.

**Function code**

A function code (FC) is a standardized method to access, i. e. read or write on coils (Bits) or registers via Modbus.

Modbus function codes are elements of Modbus request/reply telegrams.

**GSD**

Generic Station Description, Device description file

**GSD file**

A special kind of Device Description File used by PROFIBUS (GSD = Generic Station Description).

**GSDML**

Generic Station Description Markup Language

XML based device description file.

**GSDML file**

A special kind of XML-based Device Description File used by PROFINET.

## Half duplex

Half duplex denominates a telecommunication system between two communication partners which does not allow simultaneous, but alternating, communication in both directions is called a half-duplex telecommunication system. At such a system, receiving data inhibits the transmission of data. Half-duplex is the opposite of `_Full_duplex`.

## Hub

A network component connecting multiple communication partners with each other. A hub does not provide own intelligence, thus it does not analyze the data traffic and sends received data to all connected communication partners. A hub can be used for setting up a star topology.

## Industrial Ethernet

See Real-Time Ethernet

## IP

Internet Protocol.

IP belongs to the TCP/IP family of protocols and is defined in RFC791. It is based on layer 3 of the ISO/OSI 7 layer model of networking.

It is a connectionless protocol, i.e. you do not need to open a connection to a computer before sending an IP data packet to it. Therefore IP is not able to guarantee that the IP data packets really arrive at the recipient. On IP level neither the correctness of data nor the consistence and completeness are checked.

IP defines special addressing mechanisms, see IP Address.

## IP Address

Address within IP (the Internet Protocol, part of TCP/IP).

An IP address is an address identifying a device or a computer within a network using the IP protocol. IP addresses are defined as a 32 bit number. Usually, for ease of notation the IP address is divided into four 8 bit numbers which are represented in decimal notation and separated by points:

a.b.c.d

where a.b.c.d are each integer values between 0 and 255.

Example: 192.168.30.15

However, not all combinations are allowed, some are reserved for special purposes.

The IP address 0.0.0.0 is defined as invalid.

## MAC-ID

MAC = Media Access Control

*Definition for Ethernet:*

A MAC-ID is on delivery a unique (physical) Ethernet address of the device.

MAC-IDs are defined as a 48 bit number. Usually, for ease of notation the MAC-ID address is divided into six 8 bit numbers which are represented in hexadecimal notation and separated by "minus"-signs (-):



A-B-C-D-E-F

where A-B-C-D-E-F are each integer values between 0 and 255.

Example: 00-02-A2-20-91-18

*Definition for DeviceNet:* The MAC-ID is the network address of the device. The network address of a device serves to distinguish itself on a DeviceNet fieldbus system from any other device or Slave on this network. This should be a unique number for each device. A valid MAC-ID address is within a range of 0 to 63 and can be re-entered and changed in the MAC-ID box in the Device Configuration Dialog.

## Modbus Data Model

The data model distinguishes four basic types of data areas:

- Discrete Inputs (inputs) = FC 2 (Read)
- coils (outputs) = FC 1, 5, 15 (Write and Read back)
- Input register (input data) = FC 4 (Read)
- Holding register (output data) = FC 3, 6, 16, 23 (Write and Read back).

It should be noted, however, that depending on the device manufacturer and device type:

- the data area in the device may be present or not,
- and two data areas can be combined into one data region. For example, discrete inputs and input registers can be a common data area, which can be accessed with read-FC 2 and FC 4.
- Further FC 1 and FC 3 are used instead of reading back the inputs to read the outputs.

## MPI

Multi Point Interface

The MPI is a proprietary interface of the SIMATIC® S7® series of PLCs. It is compatible to PROFIBUS and based on RS-485. It usually works with a transmission rate of 187.5 kBaud.

## netX

networX on chip, Hilscher network communication controllers

## netX Configuration Tool

The netX Configuration Tool allows users to operate cifX or netX based devices in different networks. Its graphical user interface serves as a configuration tool for the installation, configuration and diagnosis of the devices.

## Object Dictionary

An object dictionary is a storage area for device parameter data structures. It is accessed in standardized manner.

## Open Modbus/TCP

A communication system for Industrial Ethernet designed and developed by Schneider Automation and maintained by the Modbus-IDA organization based on the Modbus protocols for serial communication.

**PCB**

Printed Circuit Board, (printed = machine-made) circuit board

**PCIe**

Abbreviation for PCI Express

**PC Card cifX**

Communication Interfaces of the cifX product family of Hilscher on the basis of the communication controller netX 100:

for the Real-Time Ethernet systems

- EtherCAT
- EtherNet/IP
- Open Modbus/TCP
- POWERLINK
- PROFINET IO
- sercos
- VARAN

and for the fieldbus systems

- PROFIBUS DP
- PROFIBUS MPI
- CANopen
- DeviceNet
- CC-Link

as Communication Interface netX with PCI Bus

- PCI (CIFX50),
- PCI Express (CIFX 50E),
- Low Profile PCI Express (CIFX 70E, CIFX 100EH-RE\CUBE\*),
- Compact PCI (CIFX 80),
- Mini PCI (CIFX 90),
- Mini PCI Express (CIFX 90E),
- PCI-104 (CIFX 104C)

and as Communication Interface netX with ISA Bus

- PCI-104 (CIFX 104).

\*only Real-Time Ethernet

**PROFINET**

A communication system for Industrial Ethernet designed and developed by PROFIBUS & PROFINET International (PI). It uses some mechanisms similar to those of the PROFIBUS field bus.

**PROFINET IO Controller**

A PROFINET control unit responsible for the defined run-up of an I/O subsystem and the cyclic or acyclic data exchange.

**PROFINET IO Device**

A PROFINET field device that cyclically receives output data from its IO-Controller and responds with its input data.

**RE**

RE stands for Real-Time Ethernet

**Real-Time Ethernet**

Real-Time Ethernet (Industrial Ethernet) is an extension of the Ethernet networking technology for industrial purposes with very good real-time

features and performance. There is a variety of different Real-Time Ethernet systems on the market which are incompatible with each other. The most important systems of these are

- EtherCAT
- EtherNet/IP
- Ethernet POWERLINK
- Open Modbus/TCP
- PROFINET
- sercos
- VARAN

## Register

A register is a 16-bit wide storage area for data which can be accessed and addressed as a unit by some of the Modbus Function Codes.

Depending on the used Modbus function code a single register or multiple registers sequentially located can be accessed.

Modbus differs Input Registers (FC 4) and Holding Registers (FC 3, 6, 16, 23).

## Remanent

Remanent memory holds its data even after power-off, for instance flash memory is remanent. It is also called non-volatile memory.

## RJ45

A connector type often used for Ethernet connection. It has been standardized by the Federal Communications Commission of the USA (FCC).

## sercos

A communication system for industrial Ethernet designed and developed by Bosch-Rexroth and supported by sercos International.

## Switch

A network component connecting multiple communication partners (or even entire branches of a network) with each other. A switch is an intelligent network component which analyzes network traffic in order to decide on its own. For the connected communication partners a switch behaves transparently.

## SYNC

Synchronization cycle of the master

## SYCON.net

FDT/DTM based configuration and diagnosis software by Hilscher

## TCP/IP

Transport Control Protocol/Internet Protocol connection-orientated, secure transfer protocol as basis for the Internet-protocols

**UCMM**

Unconnected Message Manager

**VARAN**

**V**ersatile **A**utomation **R**andom **A**ccess **N**etwork

A communication system for industrial Ethernet based on the DIAS-BUS developed by Sigmatek. The system is supported by the VARAN-BUS-NUTZERORGANISATION (VNO).

**Watchdog Timer**

A watchdog timer provides an internal supervision mechanism of a communication system. It supervises that an important event happens within a given timeframe (the watchdog time which can be adjusted accordingly, for instance by a parameter in the warmstart message) and causes an alarm otherwise (usually this is accomplished by changing the operational state of the communication system to a more safe state).

**X1, X2, X3, X4 ...**

serve as position names on the circuit board but can also have other or extended meanings

**X1, X2**

correspond for PC cards cifX Mini PCI Express to the Hilscher convention for „interface“ on the top or the bottom side

**X3, X4**

(names on the circuit board) ... serve for PC cards cifX Mini PCI Express with 2 channels to identify the respective communication channel:  
X3 stands for fieldbus 1 (channel X3; in SYCON.net assigned to *Ch0*).  
X4 stands for fieldbus 2 (channel X4; in SYCON.net assigned to *Ch1*).

**XDD file**

A special kind of Device Description file used by Ethernet POWERLINK.

**XML**

XML means Extended Markup Language. It is a symbolic language for structuring data systematically. XML is standard maintained by the W3C (World-wide web consortium). Device Description Files often use XML-based formats for storing the device-related data appropriately.

## 11.14 Contacts

### Headquarters

#### Germany

Hilscher Gesellschaft für  
Systemautomation mbH  
Rheinstrasse 15  
65795 Hattersheim  
Phone: +49 (0) 6190 9907-0  
Fax: +49 (0) 6190 9907-50  
E-Mail: [info@hilscher.com](mailto:info@hilscher.com)

#### Support

Phone: +49 (0) 6190 9907-99  
E-Mail: [de.support@hilscher.com](mailto:de.support@hilscher.com)

### Subsidiaries

#### China

Hilscher Systemautomation (Shanghai) Co. Ltd.  
200010 Shanghai  
Phone: +86 (0) 21-6355-5161  
E-Mail: [info@hilscher.cn](mailto:info@hilscher.cn)

#### Support

Phone: +86 (0) 21-6355-5161  
E-Mail: [cn.support@hilscher.com](mailto:cn.support@hilscher.com)

#### France

Hilscher France S.a.r.l.  
69500 Bron  
Phone: +33 (0) 4 72 37 98 40  
E-Mail: [info@hilscher.fr](mailto:info@hilscher.fr)

#### Support

Phone: +33 (0) 4 72 37 98 40  
E-Mail: [fr.support@hilscher.com](mailto:fr.support@hilscher.com)

#### India

Hilscher India Pvt. Ltd.  
New Delhi - 110 065  
Phone: +91 11 26915430  
E-Mail: [info@hilscher.in](mailto:info@hilscher.in)

#### Italy

Hilscher Italia S.r.l.  
20090 Vimodrone (MI)  
Phone: +39 02 25007068  
E-Mail: [info@hilscher.it](mailto:info@hilscher.it)

#### Support

Phone: +39 02 25007068  
E-Mail: [it.support@hilscher.com](mailto:it.support@hilscher.com)

#### Japan

Hilscher Japan KK  
Tokyo, 160-0022  
Phone: +81 (0) 3-5362-0521  
E-Mail: [info@hilscher.jp](mailto:info@hilscher.jp)

#### Support

Phone: +81 (0) 3-5362-0521  
E-Mail: [jp.support@hilscher.com](mailto:jp.support@hilscher.com)

#### Korea

Hilscher Korea Inc.  
Seongnam, Gyeonggi, 463-400  
Phone: +82 (0) 31-789-3715  
E-Mail: [info@hilscher.kr](mailto:info@hilscher.kr)

#### Switzerland

Hilscher Swiss GmbH  
4500 Solothurn  
Phone: +41 (0) 32 623 6633  
E-Mail: [info@hilscher.ch](mailto:info@hilscher.ch)

#### Support

Phone: +49 (0) 6190 9907-99  
E-Mail: [ch.support@hilscher.com](mailto:ch.support@hilscher.com)

#### USA

Hilscher North America, Inc.  
Lisle, IL 60532  
Phone: +1 630-505-5301  
E-Mail: [info@hilscher.us](mailto:info@hilscher.us)

#### Support

Phone: +1 630-505-5301  
E-Mail: [us.support@hilscher.com](mailto:us.support@hilscher.com)