

# SPECTRA POWERTWIN Panel-PC Core-i Skylake with standard Displays

USER MANUAL

Version 1.91 – November 2020



# Contents

## Preface

Revision .....	04
Copyright Notice .....	04
Acknowledgement .....	04
Disclaimer .....	04
Declaration of Conformity .....	04
Product Warranty Statement .....	05
Technical Support and Assistance .....	06
Conventions Used in this Manual .....	06
Safety Precaution .....	07
Package Contents .....	08
Ordering Information .....	09
Optional Modules and Accessories .....	17

## Chapter 1 Product Introductions

1.1 Overview .....	20
1.2 Highlights .....	20
1.3 Product Pictures.....	21
1.4 Key Features .....	21
1.5 Hardware Specification .....	22
1.6 System I/O .....	43
1.6.1 Front .....	43
1.6.2 Rear .....	44
1.6.3 Left .....	44
1.6.4 Right .....	45
1.6.5 Top .....	45

## Chapter 2 Jumpers, Switches and Connectors

2.1 Jumper Settings .....	47
2.2 Location of Jumpers, Switches and Connectors .....	47
2.2.1 Top View .....	47
2.2.2 Bottom View .....	48
2.3 List of Jumpers, Connectors and Switches .....	49
2.4 Definition of Switches .....	50
2.5 Definition of Connectors .....	54

## Chapter 3 System Setup

3.1 Removing the Top Cover .....	66
3.2 Installing a Half Size Mini PCIe Card .....	67
3.3 Installing a Full Size Mini PCIe Card .....	68
3.4 Installing a mSATA Card .....	69
3.5 Installing Antennas .....	70
3.6 Installing a SO-DIMM Module .....	72
3.7 Installing a PCI(e) Card .....	73
3.8 Installing Thermal Pad of Thermal Block.....	75
3.9 Installing a Power Ignition Daughter Board (Optional).....	76
3.10 Installing a PoE Daughter Board (Optional).....	77
3.11 Installing the Top Cover.....	78
3.12 Installing a SATA Hard Drive at Front Panel.....	79
3.13 Installing a SATA hard drive on Bottom Side.....	82
3.14 Installing a SIM Card.....	84

3.15	Installing a CFast Card.....	85
3.16	Connecting with PowerTwin Display Module.....	86
3.17	VESA Mount.....	89
3.18	Panel Mount .....	90

## Chapter 4 BIOS Setup

4.1	BIOS Introduction .....	95
4.2	Main Setup .....	96
4.2.1	System Date .....	96
4.2.2	System Time .....	96
4.3	Advanced Setup .....	97
4.3.1	ACPI Settings .....	97
4.3.2	AMT Configuration .....	98
4.3.3	PCH-FW Configuration .....	99
4.3.4	F81866 Super IO Configuration .....	100
4.3.5	Hardware Monitor .....	101
4.3.6	S5 RTC Wake Settings .....	102
4.3.7	Serial Port Console Redirection .....	103
4.3.8	CPU Configuration .....	103
4.3.9	SATA Configuration .....	104
4.3.10	CSM Configuration .....	106
4.3.11	Asmedia SATA Controller Configuration .....	108
4.3.12	USB Configuration .....	109
4.4	Chipset Setup .....	110
4.4.1	System Agent (SA) Configuration .....	110
4.4.2	PCH-IO Configuration .....	111
4.5	Security Setup .....	113
4.5.1	Administrator Password .....	113
4.5.2	User Password .....	113
4.5.3	HDD Security Configuration .....	113
4.6	Boot Setup .....	114
4.6.1	Setup Prompt Timeout.....	114
4.6.2	Bootup NumLock State .....	114
4.6.3	Quiet Boot .....	114
4.6.4	Boot Option .....	114
4.6.5	Fast Boot .....	114
4.6.6	New Boot Option Policy .....	114
4.6.7	Hard Drive BBS Priorities .....	114
4.7	Save & Exit .....	115
4.7.1	Save Changes and Exit .....	115
4.7.2	Discard Changes and Exit .....	115
4.7.3	Save Changes and Reset .....	115
4.7.4	Discard Changes and Reset .....	115
4.7.5	Save Changes .....	115
4.7.6	Discard Changes .....	115
4.7.7	Restore Defaults .....	115
4.7.8	Save as User Defaults .....	115
4.7.9	Restore User Defaults .....	115

## Chapter 5 Product Application

5.1	Digital I/O (DIO) application .....	117
5.1.1	Digital I/O Programming Guide .....	117
5.2	Digital I/O (DIO) Hardware Specification .....	124
5.2.1	DIO Connector Definition .....	125

# Preface

## Revision

Revision	Description	Date
1.00	New Release	2016/10/13
1.10	Revised Operating Temperature	2016/12/22
1.20	Modified steps of System Setup	2018/02/06
1.30	Added New Series Products Information	2018/09/07
1.40	Correction Made	2018/10/17
1.50	Correction Made	2018/11/20
1.60	PW24 R/C Product Info and Mechanical Dimensions Added	2019/01/14
1.70	Updated LAN Chip Information PW24 Product Info and Mechanical Dimensions Added	2019/05/10
1.80	Updated Watchdog / Surge Protection	2019/06/18
1.90	Edit Models names	2019/08/13
1.91	Edit MEC-LAN Controller	2020/11/19

## Copyright Notice

© 2019 by Spectra GmbH & Co. KG. All rights are reserved. No parts of this manual may be copied, modified, or reproduced in any form or by any means for commercial use without the prior written permission of Spectra GmbH & Co. KG. All information and specification provided in this manual are for reference only and remain subject to change without prior notice.

## Acknowledgement

All registered trademarks and product names mentioned herein are used for identification purposes only and may be trademarks and/or registered trademarks of their respective owners.

## Disclaimer

This manual is intended to be used as a practical and informative guide only and is subject to change without notice. It does not represent a commitment on the part of Spectra. This product might include unintentional technical or typographical errors. Changes are periodically made to the information herein to correct such errors, and these changes are incorporated into new editions of the publication

# Declaration of Conformity



## FCC

This equipment has been tested and found to comply with the limits for a Class A digital device, pursuant to Part 15 of the FCC Rules. These limits are designed to provide reasonable protection against harmful interference when the equipment is operated in a commercial environment. This equipment generates, uses, and can radiate radio frequency energy and, if not installed and used in accordance with the instruction manual, may cause harmful interference to radio communications. Operation of this equipment in a residential area is likely to cause harmful interference in which case the user will be required to correct the interference at his own expense.

## CE



The product(s) described in this manual complies with all application European Union (CE) directives if it has a CE marking. For computer systems to remain CE compliant, only CE-compliant parts may be used. Maintaining CE compliance also requires proper cable and cabling techniques.

# Product Warranty Statement

## Warranty

Spectra products are warranted by Spectra GmbH & Co. KG to be free from defect in materials and workmanship starting from the date of purchase by the original purchaser. The actual warranty period of Spectraproducts vary with product categories. During the warranty period, we shall, at our option, either repair or replace any product that proves to be defective under normal operation.

Defects, malfunctions, or failures of the warranted product caused by damage resulting from natural disasters (such as by lightning, flood, earthquake, etc.), environmental and atmospheric disturbances, other external forces such as power line disturbances, plugging the board in under power, or incorrect cabling, and damage caused by misuse, abuse, and unauthorized alteration or repair, and the product in question is either software, or an expendable item (such as a fuse, battery, etc.), are not warranted

## RMA

Before sending your product in, you will need to fill in a Spectra RMA Request Form and obtain a RMA number from us. Please go to [www.spectra.de/RMA](http://www.spectra.de/RMA) to fill in this form. Our staff is available at any time to provide you with the most friendly and immediate service.

### ■ RMA Instruction

- Customers must fill in Spectra Return Merchandise Authorization (RMA) Request Form and obtain a RMA number prior to returning a defective product to Spectra for service.
- Customers must collect all the information about the problems encountered and note anything abnormal and describe the problems on the "Spectra Service Form" for the RMA number apply process.
- Charges may be incurred for certain repairs. Spectra will charge for repairs to products whose warranty period has expired. Spectra will also charge for repairs to products if the damage resulted from acts of God, environmental or atmospheric disturbances, or other external forces through misuse, abuse, or unauthorized alteration or repair. If charges will be incurred for a repair, Spectra lists all charges, and will wait for customer's approval before performing the repair.
- Customers agree to insure the product or assume the risk of loss or damage during transit, to prepay shipping charges, and to use the original shipping container or equivalent.
- Customers can be send back the faulty products with or without accessories (manuals, cable, etc.) and any components from the system. If the components were suspected as part of the problems, please note clearly which components are included. Otherwise, Spectra is not responsible for the devices/parts.
- Repaired items will be shipped along with a "Repair Report" detailing the findings and actions taken.

## Technical Support and Assistance

1. Visit our website at [www.spectra.de](http://www.spectra.de) where you can find the latest information about the product.
2. Contact our technical support team or sales representative for technical support if you need additional assistance. Please have following information ready before you call:
  - Product name and serial number
  - Description of your peripheral attachments
  - Description of your software (operating system, version, application software, etc.)
  - A complete description of the problem
  - The exact wording of any error messages

## Conventions Used in this Manual



### WARNING

This indication alerts operators to an operation that, if not strictly observed, may result in severe injury.



### CAUTION

This indication alerts operators to an operation that, if not strictly observed, may result in safety hazards to personnel or damage to equipment.



### NOTE

This indication provides additional information to complete a task easily.

## Safety Precautions

Before installing and using this device, please note the following precautions:

1. Read these safety instructions carefully.
2. Keep this User's Manual for future reference.
3. Disconnect this equipment from any AC outlet before cleaning.
4. For plug-in equipment, the power outlet socket must be located near the equipment and must be easily accessible.
5. Keep this equipment away from humidity.
6. Put this equipment on a reliable surface during installation. Dropping it or letting it fall may cause damage.
7. Make sure the voltage of the power source is correct before connecting the equipment to the power outlet.
8. Use a power cord that has been approved for using with the product and that it matches the voltage and current marked on the product's electrical range label. The voltage and current rating of the cord must be greater than the voltage and current rating marked on the product.
9. Position the power cord so that people cannot step on it. Do not place anything over the power cord.
10. All cautions and warnings on the equipment should be noted.
11. If the equipment is not used for a long time, disconnect it from the power source to avoid damage by transient overvoltage.
12. Never pour any liquid into an opening. This may cause fire or electrical shock.
13. Never open the equipment. For safety reasons, the equipment should be opened only by qualified service personnel.

If one of the following situations arises, get the equipment checked by service personnel:

- The power cord or plug is damaged.
  - Liquid has penetrated into the equipment.
  - The equipment has been exposed to moisture.
  - The equipment does not work well, or you cannot get it work according to the user's manual.
  - The equipment has been dropped and damaged.
  - The equipment has obvious signs of breakage.
14. **CAUTION:** Danger of explosion if battery is incorrectly replaced. Replace only with the same or equivalent type recommended by the manufacturer.

## Package Contents

Before installation, please ensure all the items listed in the following table are included in the package.

Item	Description	Q'ty
1	Panel PC	1
2	Utility DVD Driver	1
3	Screw Pack	1
4	Power Terminal Block Connector	1
5	Fan Terminal Block Connector	1
6	DIO Terminal Block Connector	2
7	Power On/Off Terminal Block Connector	1
8	Screw Pack	1
9	Panel Mounting Kit	1

*Note: Notify your sales representative if any of the above items are missing or damaged.*



## Ordering Information

Model No.	Product Description
Spectra PowerTwin P12R-i7SL-P	12.1" TFT SVGA 4:3 Panel PC with Resistive 5-wire Touch and Intel 6th Gen. Core i7-6600U Fanless Computer, CFM Interface, CDS Interface
Spectra PowerTwin P12R-i7SL-PE	12.1" TFT SVGA 4:3 Panel PC with Resistive 5-wire Touch and Intel 6th Gen. Core i7-6600U Expandable Fanless Computer, CFM Interface, CDS Interface
Spectra PowerTwin P12C-i7SL-P	12.1" TFT SVGA 4:3 Panel PC with Projected Capacitive Touch and Intel 6th Gen. Core i7-6600U Fanless Computer, CFM Interface, CDS Interface
Spectra PowerTwin P12C-i7SL-PE	12.1" TFT SVGA 4:3 Panel PC with Projected Capacitive Touch and Intel 6th Gen. Core i7-6600U Expandable Fanless Computer, CFM Interface, CDS Interface

Model No.	Product Description
Spectra PowerTwin P12R-i5SL-R	12.1" TFT SVGA 4:3 Panel PC with Resistive 5-wire Touch and Intel 6th Gen. Core i5-6300U Fanless Computer, CFM Interface, CDS Interface
Spectra PowerTwin P12R-i5SL-RE	12.1" TFT SVGA 4:3 Panel PC with Resistive 5-wire Touch and Intel 6th Gen. Core i5-6300U Expandable Fanless Computer, CFM Interface, CDS Interface
Spectra PowerTwin P12C-i5SL-R	12.1" TFT SVGA 4:3 Panel PC with Projected Capacitive Touch and Intel 6th Gen. Core i5-6300U Fanless Computer, CFM Interface, CDS Interface
Spectra PowerTwin P12C-i5SL-RE	12.1" TFT SVGA 4:3 Panel PC with Projected Capacitive Touch and Intel 6th Gen. Core i5-6300U Expandable Fanless Computer, CFM Interface, CDS Interface

Model No.	Product Description
Spectra PowerTwin P12R-i3SL-R	12.1" TFT SVGA 4:3 Panel PC with Resistive 5-wire Touch and Intel 6th Gen. Core i3-6100U Fanless Computer, CFM Interface, CDS Interface
Spectra PowerTwin P12R-i3SL-RE	12.1" TFT SVGA 4:3 Panel PC with Resistive 5-wire Touch and Intel 6th Gen. Core i3-6100U Expandable Fanless Computer, CFM Interface, CDS Interface
Spectra PowerTwin P12C-i3SL-R	12.1" TFT SVGA 4:3 Panel PC with Projected Capacitive Touch and Intel 6th Gen. Core i3-6100U Fanless Computer, CFM Interface, CDS Interface
Spectra PowerTwin P12C-i3SL-RE	12.1" TFT SVGA 4:3 Panel PC with Projected Capacitive Touch and Intel 6th Gen. Core i3-6100U Expandable Fanless Computer, CFM Interface, CDS Interface

Model No.	Product Description
Spectra PowerTwin PH12R-i7SL-P	12.1" TFT XGA 4:3 Panel PC with Resistive 5-wire Touch and Intel 6th Gen. Core i7-6600U Fanless Computer, CFM Interface, CDS Interface
Spectra PowerTwin PH12R-i7SL-PE	12.1" TFT XGA 4:3 Panel PC with Resistive 5-wire Touch and Intel 6th Gen. Core i7-6600U Expandable Fanless Computer, CFM Interface, CDS Interface
Spectra PowerTwin PH12C-i7SL-P	12.1" TFT XGA 4:3 Panel PC with Projected Capacitive Touch and Intel 6th Gen. Core i7-6600U Fanless Computer, CFM Interface, CDS Interface
Spectra PowerTwin PH12C-i7SL-PE	12.1" TFT XGA 4:3 Panel PC with Projected Capacitive Touch and Intel 6th Gen. Core i7-6600U Expandable Fanless Computer, CFM Interface, CDS Interface

Model No.	Product Description
Spectra PowerTwin PH12R-i5SL-R	12.1" TFT XGA 4:3 Panel PC with Resistive 5-wire Touch and Intel 6th Gen. Core i5-6300U Fanless Computer, CFM Interface, CDS Interface
Spectra PowerTwin PH12R-i5SL-RE	12.1" TFT XGA 4:3 Panel PC with Resistive 5-wire Touch and Intel 6th Gen. Core i5-6300U Expandable Fanless Computer, CFM Interface, CDS Interface
Spectra PowerTwin PH12C-i5SL-R	12.1" TFT XGA 4:3 Panel PC with Projected Capacitive Touch and Intel 6th Gen. Core i5-6300U Fanless Computer, CFM Interface, CDS Interface
Spectra PowerTwin PH12C-i5SL-RE	12.1" TFT XGA 4:3 Panel PC with Projected Capacitive Touch and Intel 6th Gen. Core i5-6300U Expandable Fanless Computer, CFM Interface, CDS Interface

Model No.	Product Description
Spectra PowerTwin PH12R-i3SL-R	12.1" TFT XGA 4:3 Panel PC with Resistive 5-wire Touch and Intel 6th Gen. Core i3-6100U Fanless Computer, CFM Interface, CDS Interface
Spectra PowerTwin PH12R-i3SL-RE	12.1" TFT XGA 4:3 Panel PC with Resistive 5-wire Touch and Intel 6th Gen. Core i3-6100U Expandable Fanless Computer, CFM Interface, CDS Interface
Spectra PowerTwin PH12C-i3SL-R	12.1" TFT XGA 4:3 Panel PC with Projected Capacitive Touch and Intel 6th Gen. Core i3-6100U Fanless Computer, CFM Interface, CDS Interface
Spectra PowerTwin PH12C-i3SL-RE	12.1" TFT XGA 4:3 Panel PC with Projected Capacitive Touch and Intel 6th Gen. Core i3-6100U Expandable Fanless Computer, CFM Interface, CDS Interface

Model No.	Product Description
Spectra PowerTwin P15R-i7SL-P	15" TFT XGA 4:3 Panel PC with Resistive 5-wire Touch and Intel 6th Gen. Core i7-6600U Fanless Computer, CFM Interface, CDS Interface
Spectra PowerTwin P15R-i7SL-PE	15" TFT XGA 4:3 Panel PC with Resistive 5-wire Touch and Intel 6th Gen. Core i7-6600U Expandable Fanless Computer, CFM Interface, CDS Interface
Spectra PowerTwin P15C-i7SL-P	15" TFT XGA 4:3 Panel PC with Projected Capacitive Touch and Intel 6th Gen. Core i7-6600U Fanless Computer, CFM Interface, CDS Interface
Spectra PowerTwin P15C-i7SL-PE	15" TFT XGA 4:3 Panel PC with Projected Capacitive Touch and Intel 6th Gen. Core i7-6600U Expandable Fanless Computer, CFM Interface, CDS Interface

Model No.	Product Description
Spectra PowerTwin P15R-i5SL-R	15" TFT XGA 4:3 Panel PC with Resistive 5-wire Touch and Intel 6th Gen. Core i5-6300U Fanless Computer, CFM Interface, CDS Interface
Spectra PowerTwin P15R-i5SL-RE	15" TFT XGA 4:3 Panel PC with Resistive 5-wire Touch and Intel 6th Gen. Core i5-6300U Expandable Fanless Computer, CFM Interface, CDS Interface
Spectra PowerTwin P15C-i5SL-R	15" TFT XGA 4:3 Panel PC with Projected Capacitive Touch and Intel 6th Gen. Core i5-6300U Fanless Computer, CFM Interface, CDS Interface
Spectra PowerTwin P15C-i5SL-RE	15" TFT XGA 4:3 Panel PC with Projected Capacitive Touch and Intel 6th Gen. Core i5-6300U Expandable Fanless Computer, CFM Interface, CDS Interface

Model No.	Product Description
Spectra PowerTwin P15R-i3SL-R	15" TFT XGA 4:3 Panel PC with Resistive 5-wire Touch and Intel 6th Gen. Core i3-6100U Fanless Computer, CFM Interface, CDS Interface
Spectra PowerTwin P15R-i3SL-RE	15" TFT XGA 4:3 Panel PC with Resistive 5-wire Touch and Intel 6th Gen. Core i3-6100U Expandable Fanless Computer, CFM Interface, CDS Interface
Spectra PowerTwin P15C-i3SL-R	15" TFT XGA 4:3 Panel PC with Projected Capacitive Touch and Intel 6th Gen. Core i3-6100U Fanless Computer, CFM Interface, CDS Interface
Spectra PowerTwin P15C-i3SL-RE	15" TFT XGA 4:3 Panel PC with Projected Capacitive Touch and Intel 6th Gen. Core i3-6100U Expandable Fanless Computer, CFM Interface, CDS Interface

Model No.	Product Description
Spectra PowerTwin PW15R-i7SL-P	15.6" TFT WXGA 16:9 Panel PC with Resistive 5-wire Touch and Intel 6th Gen. Core i7-6600U Fanless Computer, CFM Interface, CDS Interface
Spectra PowerTwin PW15R-i7SL-PE	15.6" TFT WXGA 16:9 Panel PC with Resistive 5-wire Touch and Intel 6th Gen. Core i7-6600U Expandable Fanless Computer, CFM Interface, CDS Interface
Spectra PowerTwin PW15C-i7SL-P	15.6" TFT WXGA 16:9 Panel PC with Projected Capacitive Touch and Intel 6th Gen. Core i7-6600U Fanless Computer, CFM Interface, CDS Interface
Spectra PowerTwin PW15C-i7SL-PE	15.6" TFT WXGA 16:9 Panel PC with Projected Capacitive Touch and Intel 6th Gen. Core i7-6600U Expandable Fanless Computer, CFM Interface, CDS Interface

Model No.	Product Description
Spectra PowerTwin PW15R-i5SL-R	15.6" TFT WXGA 16:9 Panel PC with Resistive 5-wire Touch and Intel 6th Gen. Core i5-6300U Fanless Computer, CFM Interface, CDS Interface
Spectra PowerTwin PW15R-i5SL-RE	15.6" TFT WXGA 16:9 Panel PC with Resistive 5-wire Touch and Intel 6th Gen. Core i5-6300U Expandable Fanless Computer, CFM Interface, CDS Interface
Spectra PowerTwin PW15C-i5SL-R	15.6" TFT WXGA 16:9 Panel PC with Projected Capacitive Touch and Intel 6th Gen. Core i5-6300U Fanless Computer, CFM Interface, CDS Interface
Spectra PowerTwin PW15C-i5SL-RE	15.6" TFT WXGA 16:9 Panel PC with Projected Capacitive Touch and Intel 6th Gen. Core i5-6300U Expandable Fanless Computer, CFM Interface, CDS Interface

Model No.	Product Description
Spectra PowerTwin PW15R-i3SL-R	15.6" TFT WXGA 16:9 Panel PC with Resistive 5-wire Touch and Intel 6th Gen. Core i3-6100U Fanless Computer, CFM Interface, CDS Interface
Spectra PowerTwin PW15R-i3SL-RE	15.6" TFT WXGA 16:9 Panel PC with Resistive 5-wire Touch and Intel 6th Gen. Core i3-6100U Expandable Fanless Computer, CFM Interface, CDS Interface
Spectra PowerTwin PW15C-i3SL-R	15.6" TFT WXGA 16:9 Panel PC with Projected Capacitive Touch and Intel 6th Gen. Core i3-6100U Fanless Computer, CFM Interface, CDS Interface
Spectra PowerTwin PW15C-i3SL-RE	15.6" TFT WXGA 16:9 Panel PC with Projected Capacitive Touch and Intel 6th Gen. Core i3-6100U Expandable Fanless Computer, CFM Interface, CDS Interface

Model No.	Product Description
Spectra PowerTwin P17R-i7SL-P	17" TFT SXGA 5:4 Panel PC with Resistive 5-wire Touch and Intel 6th Gen. Core i7-6600U Fanless Computer, CFM Interface, CDS Interface
Spectra PowerTwin P17R-i7SL-PE	17" TFT SXGA 5:4 Panel PC with Resistive 5-wire Touch and Intel 6th Gen. Core i7-6600U Expandable Fanless Computer, CFM Interface, CDS Interface
Spectra PowerTwin P17C-i7SL-P	17" TFT SXGA 5:4 Panel PC with Projected Capacitive Touch and Intel 6th Gen. Core i7-6600U Fanless Computer, CFM Interface, CDS Interface
Spectra PowerTwin P17C-i7SL-PE	17" TFT SXGA 5:4 Panel PC with Projected Capacitive Touch and Intel 6th Gen. Core i7-6600U Expandable Fanless Computer, CFM Interface, CDS Interface

Model No.	Product Description
Spectra PowerTwin P17R-i5SL-R	17" TFT SXGA 5:4 Panel PC with Resistive 5-wire Touch and Intel 6th Gen. Core i5-6300U Fanless Computer, CFM Interface, CDS Interface
Spectra PowerTwin P17R-i5SL-RE	17" TFT SXGA 5:4 Panel PC with Resistive 5-wire Touch and Intel 6th Gen. Core i5-6300U Expandable Fanless Computer, CFM Interface, CDS Interface
Spectra PowerTwin P17C-i5SL-R	17" TFT SXGA 5:4 Panel PC with Projected Capacitive Touch and Intel 6th Gen. Core i5-6300U Fanless Computer, CFM Interface, CDS Interface
Spectra PowerTwin P17C-i5SL-RE	17" TFT SXGA 5:4 Panel PC with Projected Capacitive Touch and Intel 6th Gen. Core i5-6300U Expandable Fanless Computer, CFM Interface, CDS Interface

Model No.	Product Description
Spectra PowerTwin P17R-i3SL-R	17" TFT SXGA 5:4 Panel PC with Resistive 5-wire Touch and Intel 6th Gen. Core i3-6100U Fanless Computer, CFM Interface, CDS Interface
Spectra PowerTwin P17R-i3SL-RE	17" TFT SXGA 5:4 Panel PC with Resistive 5-wire Touch and Intel 6th Gen. Core i3-6100U Expandable Fanless Computer, CFM Interface, CDS Interface
Spectra PowerTwin P17C-i3SL-R	17" TFT SXGA 5:4 Panel PC with Projected Capacitive Touch and Intel 6th Gen. Core i3-6100U Fanless Computer, CFM Interface, CDS Interface
Spectra PowerTwin P17C-i3SL-RE	17" TFT SXGA 5:4 Panel PC with Projected Capacitive Touch and Intel 6th Gen. Core i3-6100U Expandable Fanless Computer, CFM Interface, CDS Interface

Model No.	Product Description
Spectra PowerTwin P17-i7SL-P	17" TFT SXGA 5:4 Panel PC without Touch, w/ Intel 6th Gen. Core i7-6600U Fanless Computer, CFM Interface, CDS Interface
Spectra PowerTwin P17-i7SL-PE	17" TFT SXGA 5:4 Panel PC without Touch, w/ Intel 6th Gen. Core i7-6600U Expandable Fanless Computer, CFM Interface, CDS Interface
Spectra PowerTwin P17-i5SL-R	17" TFT SXGA 5:4 Panel PC without Touch, w/ Intel 6th Gen. Core i5-6300U Fanless Computer, CFM Interface, CDS Interface
Spectra PowerTwin P17-i5SL-RE	17" TFT SXGA 5:4 Panel PC without Touch, w/ Intel 6th Gen. Core i5-6300U Expandable Fanless Computer, CFM Interface, CDS Interface
Spectra PowerTwin P17-i3SL-R	17" TFT SXGA 5:4 Panel PC without Touch, w/ Intel 6th Gen. Core i3-6100U Fanless Computer, CFM Interface, CDS Interface
Spectra PowerTwin P17-i3SL-RE	17" TFT SXGA 5:4 Panel PC without Touch, w/ Intel 6th Gen. Core i3-6100U Expandable Fanless Computer, CFM Interface, CDS Interface

Model No.	Product Description
Spectra PowerTwin P19R-i7SL-P	19" TFT SXGA 5:4 Panel PC with Resistive 5-wire Touch and Intel 6th Gen. Core i7-6600U Fanless Computer, CFM Interface, CDS Interface
Spectra PowerTwin P19R-i7SL-PE	19" TFT SXGA 5:4 Panel PC with Resistive 5-wire Touch and Intel 6th Gen. Core i7-6600U Expandable Fanless Computer, CFM Interface, CDS Interface
Spectra PowerTwin P19C-i7SL-P	19" TFT SXGA 5:4 Panel PC with Projected Capacitive Touch and Intel 6th Gen. Core i7-6600U Fanless Computer, CFM Interface, CDS Interface
Spectra PowerTwin P19C-i7SL-PE	19" TFT SXGA 5:4 Panel PC with Projected Capacitive Touch and Intel 6th Gen. Core i7-6600U Expandable Fanless Computer, CFM Interface, CDS Interface

Model No.	Product Description
Spectra PowerTwin P19R-i5SL-R	19" TFT SXGA 5:4 Panel PC with Resistive 5-wire Touch and Intel 6th Gen. Core i5-6300U Fanless Computer, CFM Interface, CDS Interface
Spectra PowerTwin P19R-i5SL-RE	19" TFT SXGA 5:4 Panel PC with Resistive 5-wire Touch and Intel 6th Gen. Core i5-6300U Expandable Fanless Computer, CFM Interface, CDS Interface
Spectra PowerTwin P19C-i5SL-R	19" TFT SXGA 5:4 Panel PC with Projected Capacitive Touch and Intel 6th Gen. Core i5-6300U Fanless Computer, CFM Interface, CDS Interface
Spectra PowerTwin P19C-i5SL-RE	19" TFT SXGA 5:4 Panel PC with Projected Capacitive Touch and Intel 6th Gen. Core i5-6300U Expandable Fanless Computer, CFM Interface, CDS Interface

Model No.	Product Description
Spectra PowerTwin P19R-i3SL-R	19" TFT SXGA 5:4 Panel PC with Resistive 5-wire Touch and Intel 6th Gen. Core i3-6100U Fanless Computer, CFM Interface, CDS Interface
Spectra PowerTwin P19R-i3SL-RE	19" TFT SXGA 5:4 Panel PC with Resistive 5-wire Touch and Intel 6th Gen. Core i3-6100U Expandable Fanless Computer, CFM Interface, CDS Interface
Spectra PowerTwin P19C-i3SL-R	19" TFT SXGA 5:4 Panel PC with Projected Capacitive Touch and Intel 6th Gen. Core i3-6100U Fanless Computer, CFM Interface, CDS Interface
Spectra PowerTwin P19C-i3SL-RE	19" TFT SXGA 5:4 Panel PC with Projected Capacitive Touch and Intel 6th Gen. Core i3-6100U Expandable Fanless Computer, CFM Interface, CDS Interface

Model No.	Product Description
Spectra PowerTwin P19-i7SL-P	19" TFT SXGA 5:4 Panel PC without Touch, w/ Intel 6th Gen. Core i7-6600U Fanless Computer, CFM Interface, CDS Interface
Spectra PowerTwin P19-i7SL-PE	19" TFT SXGA 5:4 Panel PC without Touch, w/ Intel 6th Gen. Core i7-6600U Expandable Fanless Computer, CFM Interface, CDS Interface
Spectra PowerTwin P19-i5SL-R	19" TFT SXGA 5:4 Panel PC without Touch, w/ Intel 6th Gen. Core i5-6300U Fanless Computer, CFM Interface, CDS Interface
Spectra PowerTwin P19-i5SL-RE	19" TFT SXGA 5:4 Panel PC without Touch, w/ Intel 6th Gen. Core i5-6300U Expandable Fanless Computer, CFM Interface, CDS Interface
Spectra PowerTwin P19-i3SL-R	19" TFT SXGA 5:4 Panel PC without Touch, w/ Intel 6th Gen. Core i3-6100U Fanless Computer, CFM Interface, CDS Interface
Spectra PowerTwin P19-i3SL-RE	19" TFT SXGA 5:4 Panel PC without Touch, w/ Intel 6th Gen. Core i3-6100U Expandable Fanless Computer, CFM Interface, CDS Interface

Model No.	Product Description
Spectra PowerTwin PW21R-i7SL-P	21.5" TFT Full HD 16:9 Panel PC with Resistive 5-wire Touch and Intel 6th Gen. Core i7-6600U Fanless Computer, CFM Interface, CDS Interface
Spectra PowerTwin PW21R-i7SL-PE	21.5" TFT Full HD 16:9 Panel PC with Resistive 5-wire Touch and Intel 6th Gen. Core i7-6600U Expandable Fanless Computer, CFM Interface, CDS Interface
Spectra PowerTwin PW21C-i7SL-P	21.5" TFT Full HD 16:9 Panel PC with Projected Capacitive Touch and Intel 6th Gen. Core i7-6600U Fanless Computer, CFM Interface, CDS Interface
Spectra PowerTwin PW21C-i7SL-PE	21.5" TFT Full HD 16:9 Panel PC with Projected Capacitive Touch and Intel 6th Gen. Core i7-6600U Expandable Fanless Computer, CFM Interface, CDS Interface

Model No.	Product Description
Spectra PowerTwin PW21R-i5SL-R	21.5" TFT Full HD 16:9 Panel PC with Resistive 5-wire Touch and Intel 6th Gen. Core i5-6300U Fanless Computer, CFM Interface, CDS Interface
Spectra PowerTwin PW21R-i5SL-RE	21.5" TFT Full HD 16:9 Panel PC with Resistive 5-wire Touch and Intel 6th Gen. Core i5-6300U Expandable Fanless Computer, CFM Interface, CDS Interface
Spectra PowerTwin PW21C-i5SL-R	21.5" TFT Full HD 16:9 Panel PC with Projected Capacitive Touch and Intel 6th Gen. Core i5-6300U Fanless Computer, CFM Interface, CDS Interface
Spectra PowerTwin PW21C-i5SL-RE	21.5" TFT Full HD 16:9 Panel PC with Projected Capacitive Touch and Intel 6th Gen. Core i5-6300U Expandable Fanless Computer, CFM Interface, CDS Interface

Model No.	Product Description
Spectra PowerTwin PW21R-i3SL-R	21.5" TFT Full HD 16:9 Panel PC with Resistive 5-wire Touch and Intel 6th Gen. Core i3-6100U Fanless Computer, CFM Interface, CDS Interface
Spectra PowerTwin PW21R-i3SL-RE	21.5" TFT Full HD 16:9 Panel PC with Resistive 5-wire Touch and Intel 6th Gen. Core i3-6100U Expandable Fanless Computer, CFM Interface, CDS Interface
Spectra PowerTwin PW21C-i3SL-R	21.5" TFT Full HD 16:9 Panel PC with Projected Capacitive Touch and Intel 6th Gen. Core i3-6100U Fanless Computer, CFM Interface, CDS Interface
Spectra PowerTwin PW21C-i3SL-RE	21.5" TFT Full HD 16:9 Panel PC with Projected Capacitive Touch and Intel 6th Gen. Core i3-6100U Expandable Fanless Computer, CFM Interface, CDS Interface

Model No.	Product Description
Spectra PowerTwin PW21-i7SL-P	21.5" TFT Full HD 16:9 Panel PC without Touch, w/ Intel 6th Gen. Core i7-6600U Fanless Computer, CFM Interface, CDS Interface
Spectra PowerTwin PW21-i7SL-PE	21.5" TFT Full HD 16:9 Panel PC without Touch, w/ Intel 6th Gen. Core i7-6600U Expandable Fanless Computer, CFM Interface, CDS Interface
Spectra PowerTwin PW21-i5SL-R	21.5" TFT Full HD 16:9 Panel PC without Touch, w/ Intel 6th Gen. Core i5-6300U Fanless Computer, CFM Interface, CDS Interface
Spectra PowerTwin PW21-i5SL-RE	21.5" TFT Full HD 16:9 Panel PC without Touch, w/ Intel 6th Gen. Core i5-6300U Expandable Fanless Computer, CFM Interface, CDS Interface
Spectra PowerTwin PW21-i3SL-R	21.5" TFT Full HD 16:9 Panel PC without Touch, w/ Intel 6th Gen. Core i3-6100U Fanless Computer, CFM Interface, CDS Interface
Spectra PowerTwin PW21-i3SL-RE	21.5" TFT Full HD 16:9 Panel PC without Touch, w/ Intel 6th Gen. Core i3-6100U Expandable Fanless Computer, CFM Interface, CDS Interface

Model No.	Product Description
Spectra PowerTwin PW24R-i7SL-P	24" TFT Full HD 16:9 Panel PC with Resistive 5-wire Touch and Intel 6th Gen. Core i7-6600U Fanless Computer, CFM Interface, CDS Interface
Spectra PowerTwin PW24R-i7SL-PE	24" TFT Full HD 16:9 Panel PC with Resistive 5-wire Touch and Intel 6th Gen. Core i7-6600U Expandable Fanless Computer, CFM Interface, CDS Interface
Spectra PowerTwin PW24C-i7SL-P	24" TFT Full HD 16:9 Panel PC with Projected Capacitive Touch and Intel 6th Gen. Core i7-6600U Fanless Computer, CFM Interface, CDS Interface
Spectra PowerTwin PW24C-i7SL-PE	24" TFT Full HD 16:9 Panel PC with Projected Capacitive Touch and Intel 6th Gen. Core i7-6600U Expandable Fanless Computer, CFM Interface, CDS Interface

Model No.	Product Description
Spectra PowerTwin PW24R-i5SL-R	24" TFT Full HD 16:9 Panel PC with Resistive 5-wire Touch and Intel 6th Gen. Core i5-6300U Fanless Computer, CFM Interface, CDS Interface
Spectra PowerTwin PW24R-i5SL-RE	24" TFT Full HD 16:9 Panel PC with Resistive 5-wire Touch and Intel 6th Gen. Core i5-6300U Expandable Fanless Computer, CFM Interface, CDS Interface
Spectra PowerTwin PW24C-i5SL-R	24" TFT Full HD 16:9 Panel PC with Projected Capacitive Touch and Intel 6th Gen. Core i5-6300U Fanless Computer, CFM Interface, CDS Interface
Spectra PowerTwin PW24C-i5SL-RE	24" TFT Full HD 16:9 Panel PC with Projected Capacitive Touch and Intel 6th Gen. Core i5-6300U Expandable Fanless Computer, CFM Interface, CDS Interface

Model No.	Product Description
Spectra PowerTwin PW24R-i3SL-R	24" TFT Full HD 16:9 Panel PC with Resistive 5-wire Touch and Intel 6th Gen. Core i3-6100U Fanless Computer, CFM Interface, CDS Interface
Spectra PowerTwin PW24R-i3SL-RE	24" TFT Full HD 16:9 Panel PC with Resistive 5-wire Touch and Intel 6th Gen. Core i3-6100U Expandable Fanless Computer, CFM Interface, CDS Interface
Spectra PowerTwin PW24C-i3SL-R	24" TFT Full HD 16:9 Panel PC with Projected Capacitive Touch and Intel 6th Gen. Core i3-6100U Fanless Computer, CFM Interface, CDS Interface
Spectra PowerTwin PW24C-i3SL-RE	24" TFT Full HD 16:9 Panel PC with Projected Capacitive Touch and Intel 6th Gen. Core i3-6100U Expandable Fanless Computer, CFM Interface, CDS Interface

Model No.	Product Description
Spectra PowerTwin PW24-i7SL-P	24" TFT Full HD 16:9 Panel PC without Touch, w/ Intel 6th Gen. Core i7-6600U Fanless Computer, CFM Interface, CDS Interface
Spectra PowerTwin PW24-i7SL-PE	24" TFT Full HD 16:9 Panel PC without Touch, w/ Intel 6th Gen. Core i7-6600U Expandable Fanless Computer, CFM Interface, CDS Interface
Spectra PowerTwin PW24-i5SL-R	24" TFT Full HD 16:9 Panel PC without Touch, w/ Intel 6th Gen. Core i5-6300U Fanless Computer, CFM Interface, CDS Interface
Spectra PowerTwin PW24-i5SL-RE	24" TFT Full HD 16:9 Panel PC without Touch, w/ Intel 6th Gen. Core i5-6300U Expandable Fanless Computer, CFM Interface, CDS Interface
Spectra PowerTwin PW24-i3SL-R	24" TFT Full HD 16:9 Panel PC without Touch, w/ Intel 6th Gen. Core i3-6100U Fanless Computer, CFM Interface, CDS Interface
Spectra PowerTwin PW24-i3SL-RE	24" TFT Full HD 16:9 Panel PC without Touch, w/ Intel 6th Gen. Core i3-6100U Expandable Fanless Computer, CFM Interface, CDS Interface



## Optional Modules and Accessories

Model No.	Product Description
CFM-IGN100	CFM Module with Power Ignition Sensing Control Function, 12V/24V Selectable (41 x 35 mm)
PT-i5-CFM-PoE100-R10	CFM Module with PoE Control Function, Individual Port 25.5W (50 x 44 x 15 mm) (For PowerTwin Pxx-ixSL-R only)
PT-i5-CFM-PoE101-R10	CFM Module with PoE Control Function, Individual Port 25.5W (50 x 44 x 33 mm) (For PowerTwin Pxx-ixSL-RE only)
MEC-COM-M212	Mini-PCIe Module with 2x RS-232 Serial Ports, 1x Standard DB9 Cable, 1x Universal Bracket with 2x DB9 Cutout
MEC-COM-M334	Mini-PCIe Module with 4x RS-232/422/485 Serial Ports, 2x Thin DB9 Cable, 1x Universal Bracket with 4x DB9 Cutout
MEC-LAN-Set	Mini-PCIe Module with 2x LAN Ports, 2x 30cm cable, 1x Universal Bracket with 2x RJ45 Cutout
MEC-USB	Mini-PCIe Module with 2x USB 3.0 Ports, 1x30 cm cable, 1x Universal Bracket with 2x USB Cutout
RSC-E4	Riser Card 1 x PCIe4 Slot
RSC-P	Riser Card 1 x PCI Slot
Power Adapter, 60W/12V, 3pin	Adapter AC/DC 12V 5A 60W, GST60A12-CIN1, wide temp (-30°C ~ +70°C), level VI
Power Adapter, 120W/24V, 3pin	Adapter AC/DC 24V 5A 120W, GST120A24-CIN, wide temp (-30°C ~ +70°C), level VI
Power Adapter, 220W/24V, 3pin	Adapter AC/DC 24V 9.2A 220W, GST220A24-CIN, wide temp (-30°C ~ +70°C), level VI (For PowerTwin Pxx-ixSL-RE only)
Universal Mount Kit for PowerTwin 19"	Universal 19" Rack Mount Kit for Industrial Panel PC & Industrial Monitor



Chapter 1

# Product Introductions

## 1.1 Overview

Spectra PowerTwin Pxx-ixSL Series is a high performance fanless and jumperless rugged touch panel PC powered by Intel® 6th generation Core™ processor U series, offering more computing power, faster data processing and a 40% boost to graphics performance, while consuming only 15W of power. The Spectra PowerTwin Pxx-ixSL Series supports CFM (Control Function Module) Technology, interface with integrated power boost and control signal that allows you to extend PoE and ignition sensing functions with additional CFM boards.

In addition it offers a full series of Mini-PCIe Expansion I/O Card (MEC) for adding extra I/O through the universal bracket. The Spectra PowerTwin Pxx-ixSL Series comes with the slim version, and the expandable version (PCI/PCIe card expansion) made with outstanding modular design concept for the greatest flexibility to fulfill the versatile industrial applications

The Spectra PowerTwin Pxx-ixSL Series is a truly rugged computing system supporting wide operating temperature, wide range DC input from 9V to 48V, and various kinds of industrial protections. Moreover the instant reboot circuit design allows the system to cope with critical power request for factory applications. The Spectra PowerTwin Pxx-ixSL Series has an integrated SuperCap to avoid high downtime cost of replacing CMOS battery and be absolutely maintenance-free.

## 1.2 Highlights

### CDS Technology

CDS (Convertible Display Systems) is patented technology, which is a revolutionary panel PC solution that offers features of modular design, configured on demand, scalability, transformability and Plug & Play.

### CFM Technology

CFM (Control Function Module) is a technology that enables function enhancement by adding specific function daughter board. CFM Technology allows the Spectra PowerTwin Pxx-ixSL Series to support PoE and IGN function for various applications.

### Instant Reboot

The Spectra PowerTwin Pxx-ixSL Series supports 0.2 second instant reboot for critical factory application.

### SuperCap

SuperCap is extremely high volume capacitor, which can be recharged automatically when power is connected (without power Min. 50 days / Max. 70 days), you never need to change CMOS battery, and it makes Spectra PowerTwin Pxx-ixSL Series a truly reliable and maintenance-free system.

## 1.3 Product pictures

Front



Rear

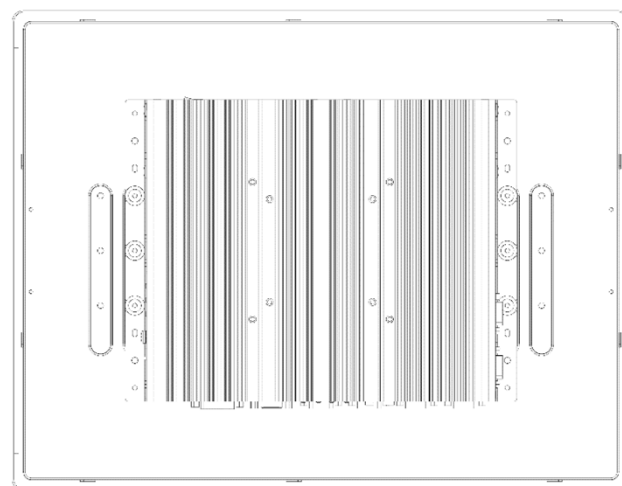
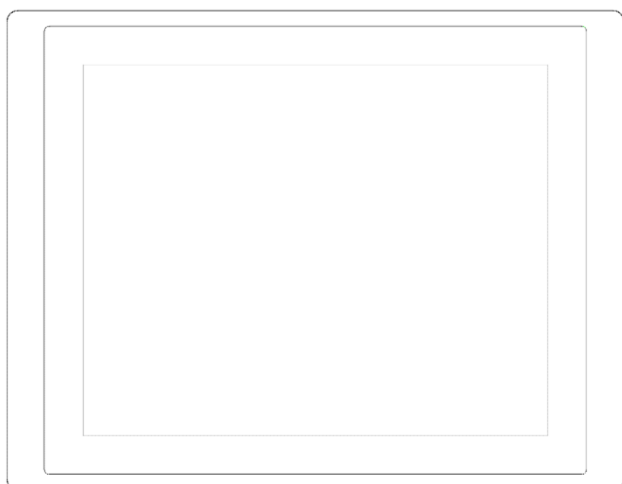

## 1.4 key Features

- 12.1" ~ 24" TFT LCD with Resistive 5-wire Touch, Projected Capacitive Touch or Glass Only (Available on Selected Models)
- Onboard Intel® 6th Generation Core™ Processor U Series (15W)
- 2x DDR4 SO-DIMM Socket, Support Up to 32 GB
- Integrated Intel® HD Graphics 520 Support Triple Display
- 2x 2.5 " SATA HDD Bay, 1x mSATA and 1x CFast Socket
- IP65 Compliant Aluminum Die-Cast Front Frame
- 2x Full-size Mini-PCIe Socket for Wireless and I/O Expansion
- Support CFM Technology for PoE and Ignition Sensing Functions
- Rich I/O (2x GbE LAN, 6x COM, 5x USB, 16x Isolated DIO)
- Support Instant Reboot Technology
- Wide Operating Temperature
- SuperCap Integrated for CMOS Battery Maintenance-free Operation for CMOS Battery Maintenance-Free
- PCI/PCIe Expandable Version Available (PowerTwin Pxxix-6x00UE)

## 1.5 Hardware Specification

### 1.5.1 PowerTwin P12-ixSL

#### PowerTwin P12R/C-ixSL-R(E)

##### Display

- LCD Size: 12.1" (4:3)
- Max. Resolution: 800 x 600
- Brightness (cd/m2): 450
- Contrast Ratio: 800 : 1
- LCD Color: 262K
- Pixel Pitch (mm): 0.3075 (H) x 0.3075 (V)
- Viewing Angle (H-V): 160 / 140
- Backlight MTBF: 50,000 hrs (LED Backlight)

##### Touch

- Resistive 5-wire Touch for PowerTwin P12R-ixSL-R(E) Only
- Projected Capacitive Touch for PowerTwin P12C-ixSL-R(E) Only

##### Physical

- Dimension (WxHxD):  
PowerTwin P12R/C-ixSL-R: 345 x 265.3 x 82 mm  
PowerTwin P12R/C-ixSL-RE: 345 x 265.3 x 100 mm
- Weight: :  
PowerTwin P12R/C-ixSL-R: 6.08 kg  
PowerTwin P12R/C-ixSL-RE: 6.34 kg
- Mechanical Construction: Rugged Aluminum Die-casting Front Bezel and Heavy Duty Metal Chassis
- Mounting: Panel / VESA Mounting / \*Rack Mounting (\*with optional mounting kit)
- Fanless Design
- Jumper-less Design

##### Environment

- Operating Temperature: -20°C to 70°C  
(with extended temperature peripherals;  
Ambient with air flow; According to IEC60068-2-1,  
IEC60068-2-2, IEC60068-2-14)
- Storage Temperature: -30°C to 80°C
- Relative Humidity: 80% RH @ 40°C (Non-Condensing)
- EMC: CE, FCC Class A

#### PowerTwin PH12R/C-ixSL-R(E)

##### Display

- LCD Size: 12.1" (4:3)
- Max. Resolution: 1024 x 768
- Brightness (cd/m2): 500
- Contrast Ratio: 700 : 1
- LCD Color: 16.2M
- Pixel Pitch (mm): 0.24 (H) x 0.24 (V)
- Viewing Angle (H-V): 160 / 160
- Backlight MTBF: 30,000 hrs (LED Backlight)

##### Touch

- Resistive 5-wire Touch for PH12R-ixSL-R(E) Only
- Projected Capacitive Touch for PH12C-ixSL-R(E) Only

##### Physical

- Dimension (WxHxD):  
PH12R/C-ixSL-R: 345 x 265.3 x 82 mm  
PH12R/C-ixSL-RE: 345 x 265.3 x 100 mm
- Weight: :  
PH12R/C-ixSL-R: 6.08 kg  
PH12R/C-ixSL-RE: 6.34 kg
- Mechanical Construction: Rugged Aluminum Die-casting Front Bezel and Heavy Duty Metal Chassis
- Mounting: Panel / VESA Mounting / \*Rack Mounting (\*with optional mounting kit)
- Fanless Design
- Jumper-less Design

##### Environment

- Operating Temperature: -20°C to 70°C  
(with extended temperature peripherals;  
Ambient with air flow; According to IEC60068-2-1,  
IEC60068-2-2, IEC60068-2-14)
- Storage Temperature: -30°C to 80°C
- Relative Humidity: 80% RH @ 40°C (Non-Condensing)
- EMC: CE, FCC Class A

## Processor System

- Onboard 6th Intel® Core™ U processors (Skylake)
  - Intel® Core™ i5-6300U processor (3M Cache, up to 3.00 GHz)
  - Intel® Core™ i3-6100U processor (3M Cache, 2.30 GHz)
  - TDP: 15 W
  - BIOS: AMI 64Mbit SPI BIOS

Or Core-i7-6600U upon request

## Memory

- 2x DDR4 260-pin SO-DIMM socket, support up to 32 GB (2133MHz, un-buffered and non-ECC type)

## Graphics

- Intel® HD Graphics 520
- Triple independent display with 1x VGA, 1x DVI-D and 1x CDS interface

## Audio

- Realtek® ALC888-GR
- High Definition Audio

## I/O Interface

- 1x VGA (Up to 1920 x 1080 @ 60Hz), DB-15
- 1x DVI-D (Up to 1920 x 1080 @ 60Hz)
- 1x CDS Interface, Compact PCI Connector
- 2x GbE LAN (Support WoL, Teaming, Jumbo Frame and PXE), RJ45
  - GbE1: Intel I219LM
  - GbE2: Intel I210IT
- 2x PoE+ (with Optional CFM PoE Module)
  - Comply with IEEE 802.3at
  - Individual Port Offers Up to 25.5W
- 6x RS-232/422/485 with Auto Flow Control, DB9
  - Supports 5V/12V Selectable by DIP Switch
- 4x USB 3.0, Type-A
- 1x USB 2.0, Type-A
- 16x Isolated DIO (8x DI/8x DO), 20-Pin Terminal Block
- 1x Line-out & 1x Mic-in, Phone Jack 3.5mm
- 1x Power On/Off Switch
- 1x Reset Button
- 1x AT/ATX Switch
- 1x Remote Power On/Off Connector, 2-Pin Terminal Block
- 1x External FAN Connector, 4-Pin Terminal Block

## Storage

- 2x 2.5" SATA HDD/SSD Bay, Support RAID 0/1 (Gen3)
- 2x mSATA (One Shared by Mini-PCIe Socket) (Gen2)
- 1x CFAST Socket (Gen3)

## Expansion

- 1x CFM PoE interface
- 1x CFM IGN interface
- 2x Full-size Mini-PCIe Socket
- 1x PCI or 1x PCIe4 Socket (For P(H)12R/C-ixSL-RE only)
- 1x Universal I/O Bracket
- 1x SIM Socket
- 4x Antenna Hole

## Other Function

- Support CDS Technology
- Support CFM Technology
- Support Instant Reboot Technology (0.2 sec)
- Support Power Ignition Sensing (IGN)
- Support OSD Function (LCD On/Off, Brightness Up, Brightness Down for CDS Display Module)
- Internal Speaker AMP 2W + 2W
- SuperCap Integrated for CMOS Battery Maintenance-free Operation
- Watchdog Timer: Software Programmable Supports 1~256 Levels System Reset

## Power Requirement

- Support AT/ATX Power Mode
- Power Input Voltage 9~48VDC
- One 3-pin Terminal Block Connector
- Power Adapter AC/DC 12V/5A 60W, 24V/5A 120W or 24V/9.2A 220W (Optional)

## Protection

- Reverse Power Input Protection
- Over Voltage Protection: 58V
- Over Current Protection: 15A
- ESD Protection: +/-15kV (air), +/-8kV (contact)
- Surge Protection: 3.84kW (impedance 12 Ohm 1.2/50µs waveform)

## Operating System

- Windows® 10 / 8.1 / 7
- Linux® Kernel 4.4

Dimensions

**PowerTwin P(H)12R/C-ixSL-R**

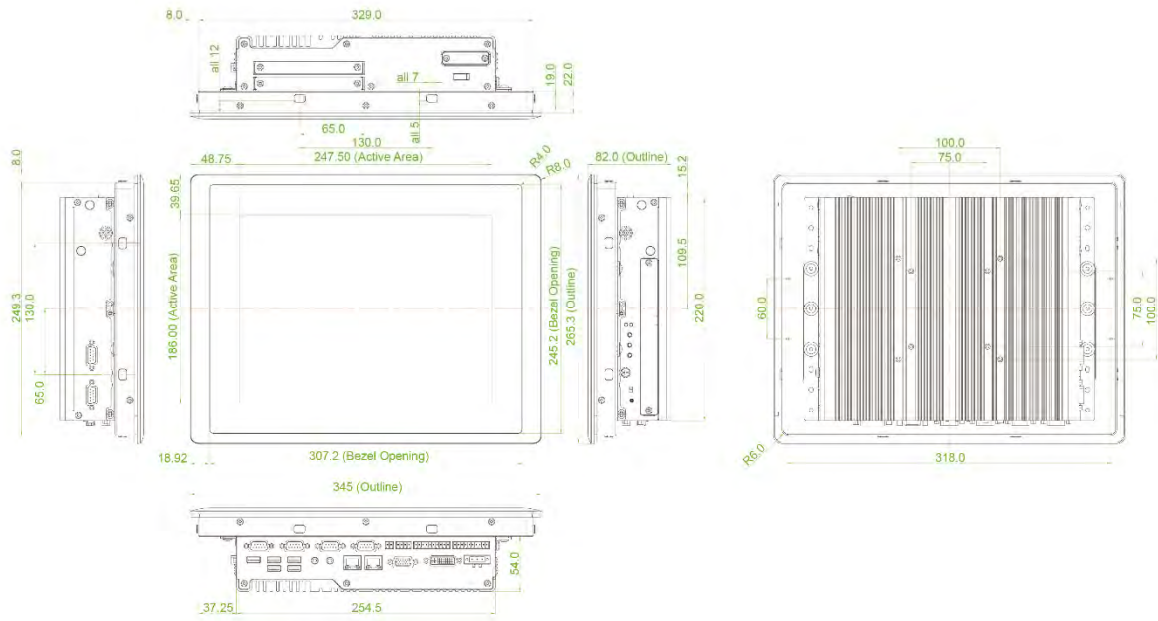

**PowerTwin P(H)12R/C-ixSL-RE**

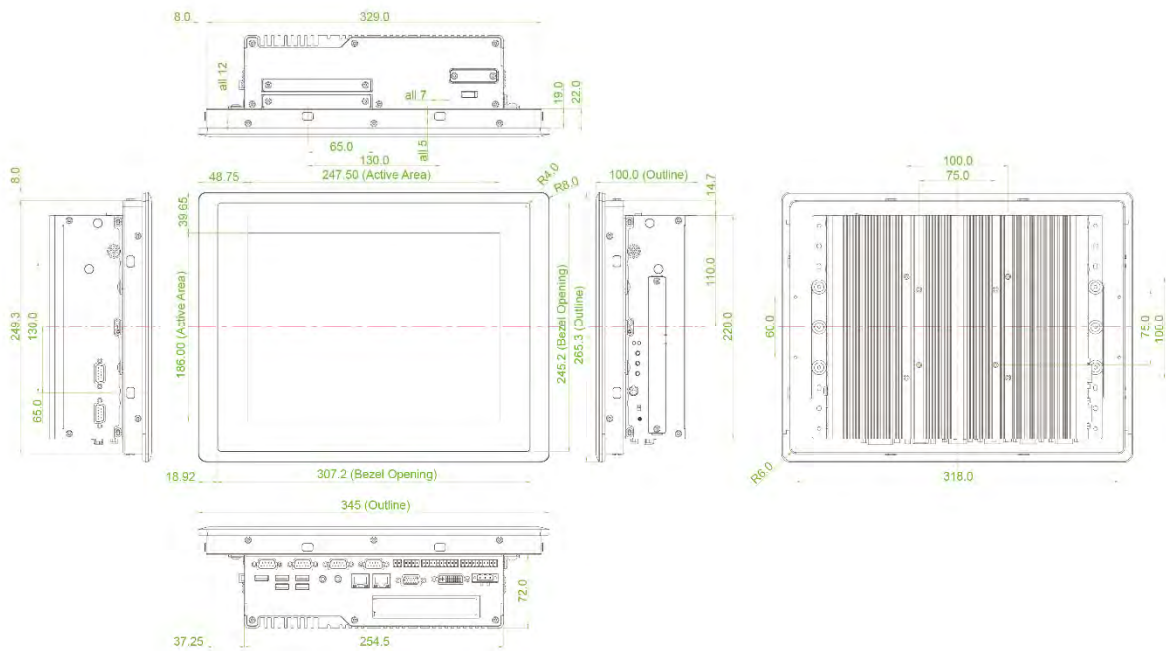



## 1.5.2 PowerTwin P15R/C-ixSL

### PowerTwin P15R/C-ixSL-R(E)

#### Display

- LCD Size: 15" (4:3)
- Max. Resolution: 1024 x 768
- Brightness (cd/m2): 350
- Contrast Ratio: 800 : 1
- LCD Color: 16.2M
- Pixel Pitch (mm): 0.297 (H) x 0.297 (V)
- Viewing Angle (H-V): 160 / 150
- Backlight MTBF: 50,000 hrs (LED Backlight)

#### Touch

- Resistive 5-wire Touch for PowerTwin P15R-ixSL-R(E) Only
- Projected Capacitive Touch for PowerTwin P15C-ixSL-R(E) Only

#### Physical

- Dimension (WxHxD):  
PowerTwin P15R/C-ixSL-R: 408 x 312.4 x 84.5 mm  
PowerTwin P15R/C-ixSL-RE: 408 x 312.4 x 102.5 mm
- Weight: :  
PowerTwin P15R/C-ixSL-R : 7.28 kg  
PowerTwin P15R/C-ixSL-RE: 7.54 kg
- Mechanical Construction: Rugged Aluminum Die-casting Front Bezel and Heavy Duty Metal Chassis
- Mounting: Panel / VESA Mounting / \*Rack Mounting (\*with optional mounting kit)
- Fanless Design
- Jumper-less Design

#### Environment

- Operating Temperature: 0°C to 65°C  
(with extended temperature peripherals; Ambient with air flow; According to IEC60068-2-1, IEC60068-2-2, IEC60068-2-14)
- Storage Temperature: -20°C to 65°C
- Relative Humidity: 80% RH @ 40°C (Non-Condensing)
- EMC: CE, FCC Class A

## Processor System

- Onboard 6th Intel® Core™ U processors (Skylake)
  - Intel® Core™ i5-6300U processor (3M Cache, up to 3.00 GHz)
  - Intel® Core™ i3-6100U processor (3M Cache, 2.30 GHz)
  - TDP: 15 W
  - BIOS: AMI 64Mbit SPI BIOS

Or Core-i7-6600U upon request

## Memory

- 2x DDR4 260-pin SO-DIMM socket, support up to 32 GB (2133MHz, un-buffered and non-ECC type)

## Graphics

- Intel® HD Graphics 520
- Triple independent display with 1x VGA, 1x DVI-D and 1x CDS interface

## Audio

- Realtek® ALC888-GR
- High Definition Audio

## I/O Interface

- 1x VGA (Up to 1920 x 1080 @ 60Hz), DB-15
- 1x DVI-D (Up to 1920 x 1080 @ 60Hz)
- 1x CDS Interface, Compact PCI Connector
- 2x GbE LAN (Support WoL, Teaming, Jumbo Frame and PXE), RJ45
  - GbE1: Intel I219LM
  - GbE2: Intel I210IT
- 2x PoE+ (with Optional CFM PoE Module)
  - Comply with IEEE 802.3at
  - Individual Port Offers Up to 25.5W Per Port
- 6x RS-232/422/485 with Auto Flow Control, DB9
  - Supports 5V/12V Selectable by DIP Switch
- 4x USB 3.0, Type-A
- 1x USB 2.0, Type-A
- 16x Isolated DIO (8x DI/8x DO), 20-Pin Terminal Block
- 1x Line-out & 1x Mic-in, Phone Jack 3.5mm
- 1x Power On/Off Switch
- 1x Reset Button
- 1x AT/ATX Switch
- 1x Remote Power On/Off Connector, 2-Pin Terminal Block
- 1x External FAN Connector, 4-Pin Terminal Block

## Storage

- 2x 2.5" SATA HDD/SSD Bay, Support RAID 0/1 (Gen3)
- 2x mSATA (One Shared by Mini-PCIe Socket) (Gen2)
- 1x CFAST Socket (Gen3)

## Expansion

- 1x CFM PoE interface
- 1x CFM IGN interface
- 2x Full-size Mini-PCIe Socket
- 1x PCI or 1x PCIe4 Socket (For P15R/C-ixSL-RE only)
- 1x Universal I/O Bracket
- 1x SIM Socket
- 4x Antenna Hole

## Other Function

- Support CDS Technology
- Support CFM Technology
- Support Instant Reboot Technology (0.2 sec)
- Support Power Ignition Sensing (IGN)
- Support OSD Function (LCD On/Off, Brightness Up, Brightness Down for CDS Display Module)
- Internal Speaker AMP 2W + 2W
- SuperCap Integrated for CMOS Battery Maintenance-free Operation
- Watchdog Timer: Software Programmable Supports 1~256 Levels System Reset

## Power Requirement

- Support AT/ATX Power Mode
- Power Input Voltage 9~48VDC
- One 3-pin Terminal Block Connector
- Power Adapter AC/DC 12V/5A 60W, 24V/5A 120W or 24V/9.2A 220W (Optional)

## Protection

- Reverse Power Input Protection
- Over Voltage Protection: 58V
- Over Current Protection: 15A
- ESD Protection: +/-15kV (air), +/-8kV (contact)
- Surge Protection: 3.84kW (impedance 12 Ohm 1.2/50µs waveform)

## Operating System

- Windows® 10 / 8.1 / 7
- Linux® Kernel 4.4

Dimensions

PowerTwin P15R/C-ixSL-R

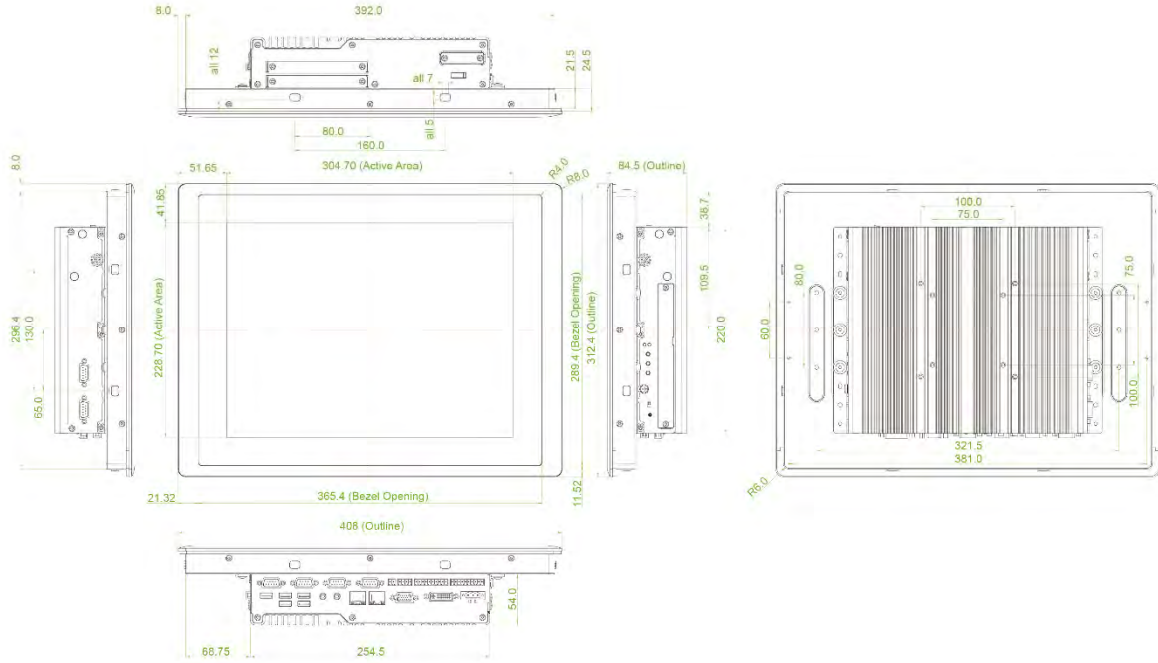

PowerTwin P15R/C-ixSL-RE

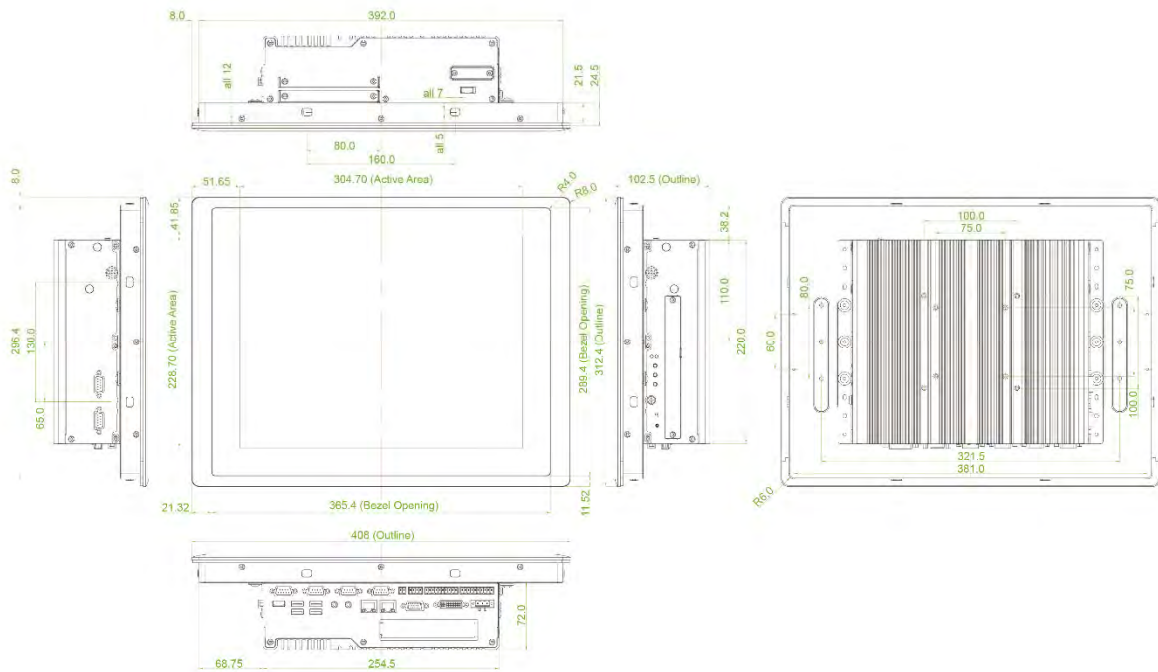

## 1.5.3 PowerTwin PW15R/C-ixSL

### PowerTwin PW15R/C-ixSL-R(E)

#### Display

- LCD Size: 15.6" (16:9)
- Max. Resolution: 1366 x 768
- Brightness (cd/m2): 400
- Contrast Ratio: 500 : 1
- LCD Color: 16.2M
- Pixel Pitch (mm): 0.252 (H) x 0.252 (V)
- Viewing Angle (H-V): 170 / 160
- Backlight MTBF: 50,000 hrs (LED Backlight)

#### Touch

- Resistive 5-wire Touch for PowerTwin PW15R-ixSL-R(E) Only
- Projected Capacitive Touch for PowerTwin PW15C-ixSL-R(E) Only

#### Physical

- Dimension (WxHxD):
  - PowerTwin PW15R/C-ixSL-R: 420 x 254 x 91.5 mm
  - PowerTwin PW15R/C-ixSL-RE: 420 x 254 x 109.5 mm
- Weight: :
  - PowerTwin PW15R/C-ixSL-R: 7.17 kg
  - PowerTwin PW15R/C-ixSL-RE: 7.43 kg
- Mechanical Construction: Rugged Aluminum Die-casting Front Bezel and Heavy Duty Metal Chassis
- Mounting: Panel / VESA Mounting / \*Rack Mounting (\*with optional mounting kit)
- Fanless Design
- Jumper-less Design

#### Environment

- Operating Temperature: 0°C to 60°C  
(with extended temperature peripherals; Ambient with air flow; According to IEC60068-2-1, IEC60068-2-2, IEC60068-2-14)
- Storage Temperature: -20°C to 60°C
- Relative Humidity: 80% RH @ 40°C (Non-Condensing)
- EMC: CE, FCC Class A

## Processor System

- Onboard 6th Intel® Core™ U processors (Skylake)
  - Intel® Core™ i5-6300U processor (3M Cache, up to 3.00 GHz)
  - Intel® Core™ i3-6100U processor (3M Cache, 2.30 GHz)
  - TDP: 15 W
  - BIOS: AMI 64Mbit SPI BIOS

Or Core-i7-6600U upon request

## Memory

- 2x DDR4 260-pin SO-DIMM socket, support up to 32 GB (2133MHz, un-buffered and non-ECC type)

## Graphics

- Intel® HD Graphics 520
- Triple independent display with 1x VGA, 1x DVI-D and 1x CDS interface

## Audio

- Realtek® ALC888-GR
- High Definition Audio

## I/O Interface

- 1x VGA (Up to 1920 x 1080 @ 60Hz), DB-15
- 1x DVI-D (Up to 1920 x 1080 @ 60Hz)
- 1x CDS Interface, Compact PCI Connector
- 2x GbE LAN (Support WoL, Teaming, Jumbo Frame and PXE), RJ45
  - GbE1: Intel I219LM
  - GbE2: Intel I210IT
- 2x PoE+ (with Optional CFM PoE Module)
  - Comply with IEEE 802.3at
  - Individual Port Offers Up to 25.5W
- 6x RS-232/422/485 with Auto Flow Control, DB9
  - Supports 5V/12V Selectable by DIP Switch
- 4x USB 3.0, Type-A
- 1x USB 2.0, Type-A
- 16x Isolated DIO (8x DI/8x DO), 20-Pin Terminal Block
- 1x Line-out & 1x Mic-in, Phone Jack 3.5mm
- 1x Power On/Off Switch
- 1x Reset Button
- 1x AT/ATX Switch
- 1x Remote Power On/Off Connector, 2-Pin Terminal Block
- 1x External FAN Connector, 4-Pin Terminal Block

## Storage

- 2x 2.5" SATA HDD/SSD Bay, Support RAID 0/1 (Gen3)
- 2x mSATA (One Shared by Mini-PCIe Socket) (Gen2)
- 1x CFAST Socket (Gen3)

## Expansion

- 1x CFM PoE interface
- 1x CFM IGN interface
- 2x Full-size Mini-PCIe Socket
- 1x PCI or 1x PCIe4 Socket (For PW15R/C-ixSL-RE only)
- 1x Universal I/O Bracket
- 1x SIM Socket
- 4x Antenna Hole

## Other Function

- Support CDS Technology
- Support CFM Technology
- Support Instant Reboot Technology (0.2 sec)
- Support Power Ignition Sensing (IGN)
- Support OSD Function (LCD On/Off, Brightness Up, Brightness Down for CDS Display Module)
- Internal Speaker AMP 2W + 2W
- SuperCap Integrated for CMOS Battery Maintenance-free Operation
- Watchdog Timer: Software Programmable Supports 1~256 Levels System Reset

## Power Requirement

- Support AT/ATX Power Mode
- Power Input Voltage 9~48VDC
- One 3-pin Terminal Block Connector
- Power Adapter AC/DC 12V/5A 60W, 24V/5A 120W or 24V/9.2A 220W (Optional)

## Protection

- Reverse Power Input Protection
- Over Voltage Protection: 58V
- Over Current Protection: 15A
- ESD Protection: +/-15kV (air), +/-8kV (contact)
- Surge Protection: 3.84kW (impedance 12 Ohm 1.2/50µs waveform)

## Operating System

- Windows® 10 / 8.1 / 7
- Linux® Kernel 4.4

Dimensions

PowerTwin PW15R/C-ixSL-R

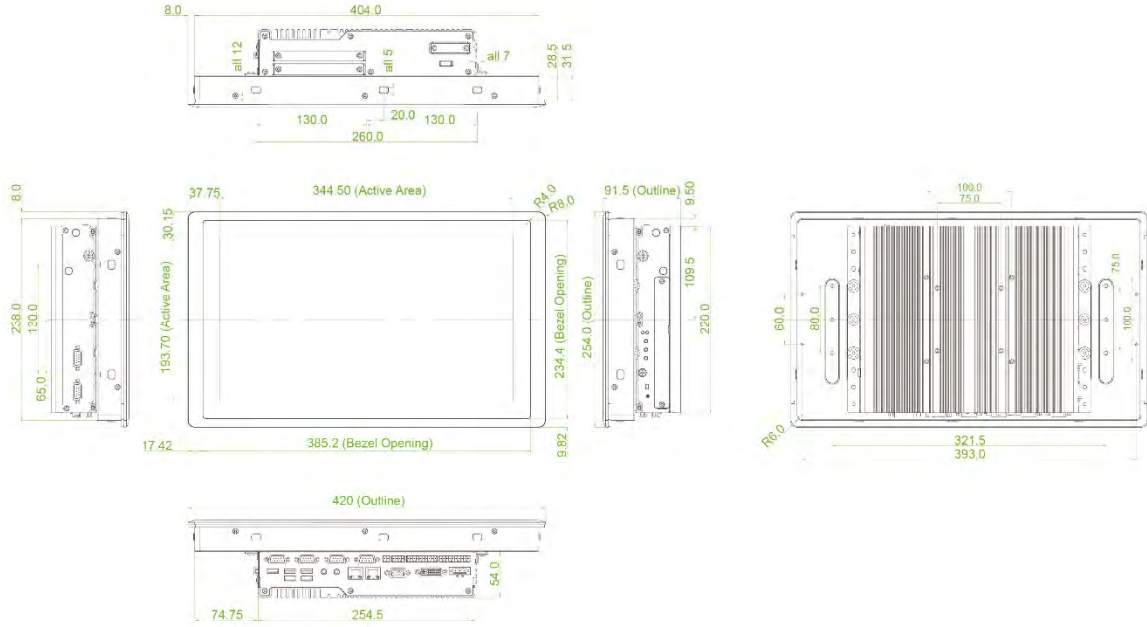

PowerTwin PW15R/C-ixSL-RE

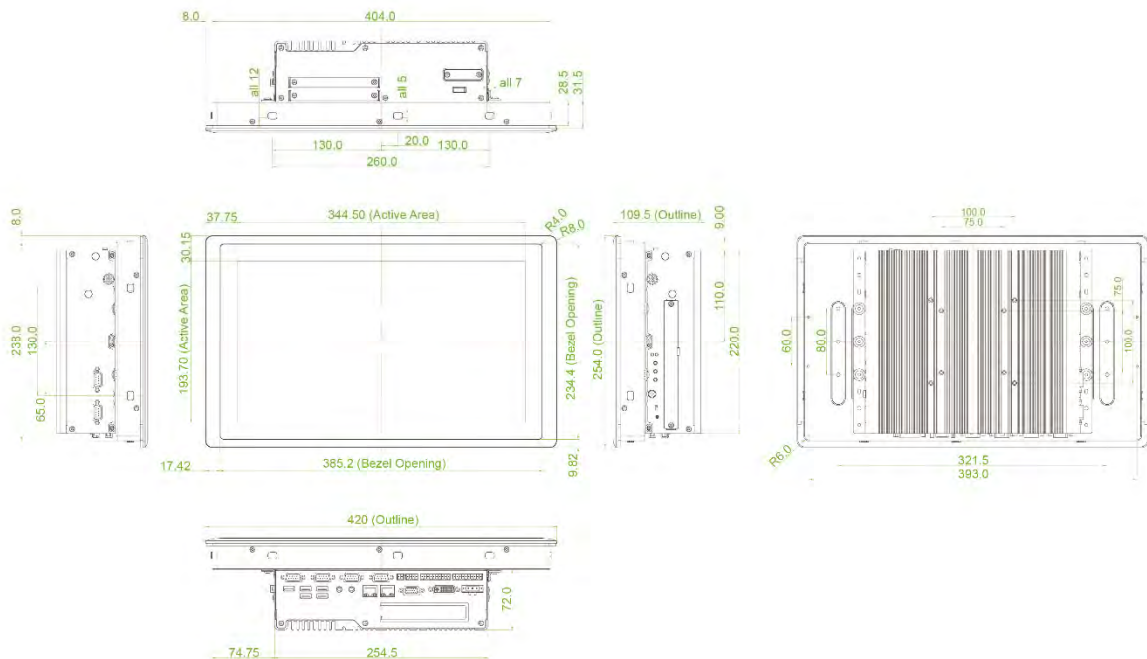

## 1.5.4 PowerTwin P17R/C-ixSL

### PowerTwin P17R/C-ixSL-R(E)

#### Display

- LCD Size: 17" (5:4)
- Max. Resolution: 1280 x 1024
- Brightness (cd/m<sup>2</sup>): 350
- Contrast Ratio: 800 : 1
- LCD Color: 16.7M
- Pixel Pitch (mm): 0.264 (H) x 0.264 (V)
- Viewing Angle (H-V): 160 / 140
- Backlight MTBF: 50,000 hrs (LED Backlight)

#### Touch

- Resistive 5-wire Touch for PowerTwin P17R-ixSL-R(E) Only
- Projected Capacitive Touch for PowerTwin P17C-ixSL-R(E) Only

#### Physical

- Dimension (WxHxD):
  - PowerTwin P17R/C-ixSL-R: 450 x 350 x 88.5 mm
  - PowerTwin P17R/C-ixSL-RE: 450 x 350 x 106.5 mm
- Weight: :
  - PowerTwin P17R/C-ixSL-R: 8.56 kg
  - PowerTwin P17R/C-ixSL-RE: 8.82 kg
- Mechanical Construction: Rugged Aluminum Die-casting Front Bezel and Heavy Duty Metal Chassis
- Mounting: Panel / VESA Mounting / \*Rack Mounting (\*with optional mounting kit)
- Fanless Design
- Jumper-less Design

#### Environment

- Operating Temperature:
  - PowerTwin P17R-ixSL-R(E): -20°C to 70°C
  - PowerTwin P17C-ixSL-R(E): -20°C to 70°C
  - PowerTwin P17-ixSL-R(E) : -25°C to 70°C(with extended temperature peripherals; Ambient with air flow; According to IEC60068-2-1, IEC60068-2-2, IEC60068-2-14)
- Storage Temperature:
  - PowerTwin P17R-ixSL-R(E): -30°C to 80°C
  - PowerTwin P17C-ixSL-R(E) : -30°C to 80°C
  - PowerTwin P17-ixSL-R(E): -30°C to 85°C
- Relative Humidity:
  - PowerTwin P17R-ixSL-R(E) : 80% RH @ 40°C (Non-Condensing)
  - PowerTwin P17C-ixSL-R(E): 80% RH @ 40°C (Non-Condensing)
  - PowerTwin P17-ixSL-R(E): 90% RH @ 40°C (Non-Condensing)
- EMC: CE, FCC Class A

## Processor System

- Onboard 6th Intel® Core™ U processors (Skylake)
  - Intel® Core™ i5-6300U processor (3M Cache, up to 3.00 GHz)
  - Intel® Core™ i3-6100U processor (3M Cache, 2.30 GHz)
  - TDP: 15 W
  - BIOS: AMI 64Mbit SPI BIOS

Or Core-i7-6600U upon request

## Memory

- 2x DDR4 260-pin SO-DIMM socket, support up to 32 GB (2133MHz, un-buffered and non-ECC type)

## Graphics

- Intel® HD Graphics 520
- Triple independent display with 1x VGA, 1x DVI-D and 1x CDS interface

## Audio

- Realtek® ALC888-GR
- High Definition Audio

## I/O Interface

- 1x VGA (Up to 1920 x 1080 @ 60Hz), DB-15
- 1x DVI-D (Up to 1920 x 1080 @ 60Hz)
- 1x CDS Interface, Compact PCI Connector
- 2x GbE LAN (Support WoL, Teaming, Jumbo Frame and PXE), RJ45
  - GbE1: Intel I219LM
  - GbE2: Intel I210IT
- 2x PoE+ (with Optional CFM PoE Module)
  - Comply with IEEE 802.3at
  - Individual Port Offers Up to 25.5W
- 6x RS-232/422/485 with Auto Flow Control, DB9
  - Supports 5V/12V Selectable by DIP Switch
- 4x USB 3.0, Type-A
- 1x USB 2.0, Type-A
- 16x Isolated DIO (8x DI/8x DO), 20-Pin Terminal Block
- 1x Line-out & 1x Mic-in, Phone Jack 3.5mm
- 1x Power On/Off Switch
- 1x Reset Button
- 1x AT/ATX Switch
- 1x Remote Power On/Off Connector, 2-Pin Terminal Block
- 1x External FAN Connector, 4-Pin Terminal Block

## Storage

- 2x 2.5" SATA HDD/SSD Bay, Support RAID 0/1 (Gen3)
- 2x mSATA (One Shared by Mini-PCIe Socket) (Gen2)
- 1x CFAST Socket (Gen3)

## Expansion

- 1x CFM PoE interface
- 1x CFM IGN interface
- 2x Full-size Mini-PCIe Socket
- 1x PCI or 1x PCIe4 Socket (For P17R/C-ixSL-RE only)
- 1x Universal I/O Bracket
- 1x SIM Socket
- 4x Antenna Hole

## Other Function

- Support CDS Technology
- Support CFM Technology
- Support Instant Reboot Technology (0.2 sec)
- Support Power Ignition Sensing (IGN)
- Support OSD Function (LCD On/Off, Brightness Up, Brightness Down for CDS Display Module)
- Internal Speaker AMP 2W + 2W
- SuperCap Integrated for CMOS Battery Maintenance-free Operation
- Watchdog Timer: Software Programmable Supports 1~256 Levels System Reset

## Power Requirement

- Support AT/ATX Power Mode
- Power Input Voltage 9~48VDC
- One 3-pin Terminal Block Connector
- Power Adapter AC/DC 12V/5A 60W, 24V/5A 120W or 24V/9.2A 220W (Optional)

## Protection

- Reverse Power Input Protection
- Over Voltage Protection: 58V
- Over Current Protection: 15A
- ESD Protection: +/-15kV (air), +/-8kV (contact)
- Surge Protection: 3.84kW (impedance 12 Ohm 1.2/50µs waveform)

## Operating System

- Windows® 10 / 8.1 / 7
- Linux® Kernel 4.4



Dimensions

PowerTwin P17R/C-ixSL-R

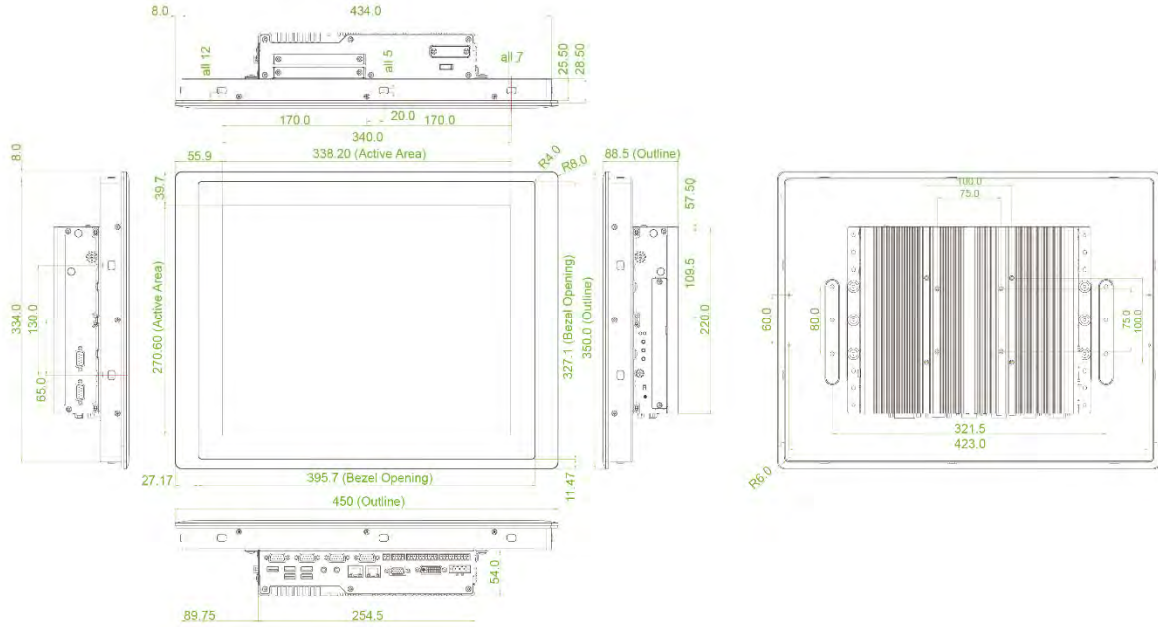

PowerTwin P17R/C-ixSL-RE

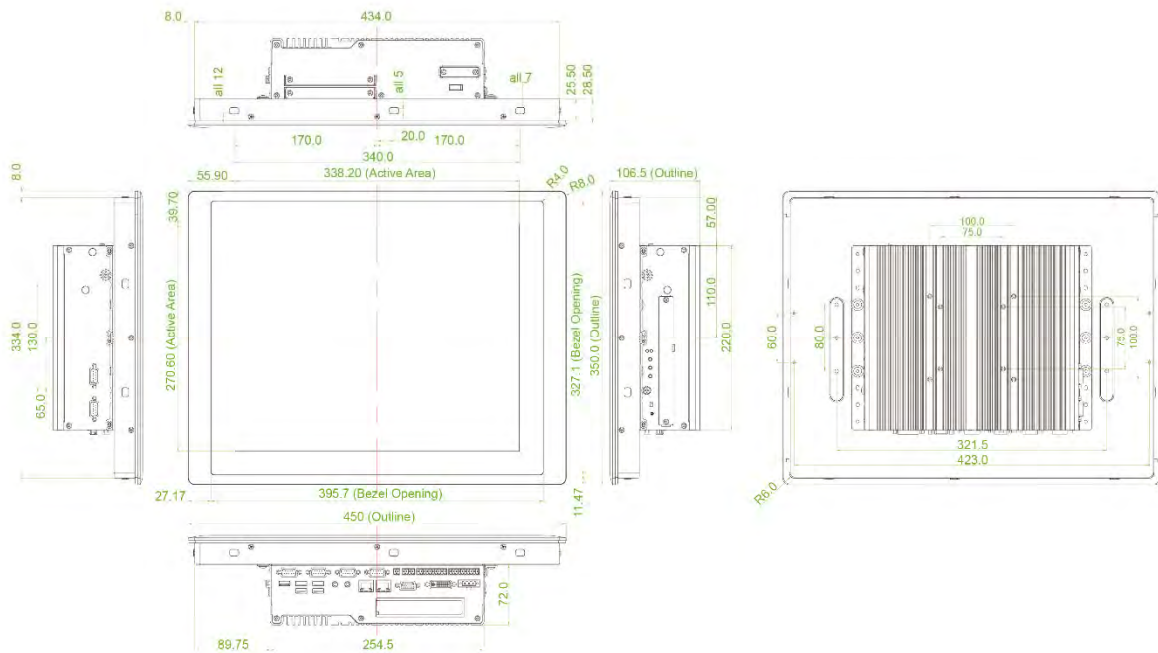

## 1.5.5 PowerTwin P19R/C-ixSL

### PowerTwin P19R/C-ixSL-R(E)

#### Display

- LCD Size: 19" (5:4)
- Max. Resolution: 1280 x 1024
- Brightness (cd/m2): 350
- Contrast Ratio: 1000 : 1
- LCD Color: 16.7M
- Pixel Pitch (mm): 0.294 (H) x 0.294 (V)
- Viewing Angle (H-V): 170 / 160
- Backlight MTBF: 50,000 hrs (LED Backlight)

#### Touch

- Resistive 5-wire Touch for PowerTwin P19R-ixSL-R(E) Only
- Projected Capacitive Touch for PowerTwin P19C-ixSL-R(E) Only

#### Physical

- Dimension (WxHxD):  
PowerTwin P19R/C-ixSL-R: 510 x 389.3 x 88.5 mm  
PowerTwin P19R/C-ixSL-RE: 510 x 389.3 x 106.5 mm
- Weight: :  
PowerTwin P19R/C-ixSL-R: 9.88 kg  
PowerTwin P19R/C-ixSL-RE: 10.14 kg
- Mechanical Construction: Rugged Aluminum Die-casting Front Bezel and Heavy Duty Metal Chassis
- Mounting: Panel / VESA Mounting / \*Rack Mounting (\*with optional mounting kit)
- Fanless Design
- Jumper-less Design

#### Environment

- Operating Temperature: 0°C to 50°C  
(with extended temperature peripherals; Ambient with air flow; According to IEC60068-2-1, IEC60068-2-2, IEC60068-2-14)
- Storage Temperature: -20°C to 60°C
- Relative Humidity:  
PowerTwin P19R-ixSL-R(E) : 80% RH @ 40°C (Non-Condensing)  
PowerTwin P19C-ixSL-R(E) : 80% RH @ 40°C (Non-Condensing)  
PowerTwin P19-ixSL-R(E): 90% RH @ 40°C (Non-Condensing)
- EMC: CE, FCC Class A

## Processor System

- Onboard 6th Intel® Core™ U processors (Skylake)
  - Intel® Core™ i5-6300U processor (3M Cache, up to 3.00 GHz)
  - Intel® Core™ i3-6100U processor (3M Cache, 2.30 GHz)
  - TDP: 15 W
  - BIOS: AMI 64Mbit SPI BIOS

Or Core-i7-6600U upon request

## Memory

- 2x DDR4 260-pin SO-DIMM socket, support up to 32 GB (2133MHz, un-buffered and non-ECC type)

## Graphics

- Intel® HD Graphics 520
- Triple independent display with 1x VGA, 1x DVI-D and 1x CDS interface

## Audio

- Realtek® ALC888-GR
- High Definition Audio

## I/O Interface

- 1x VGA (Up to 1920 x 1080 @ 60Hz), DB-15
- 1x DVI-D (Up to 1920 x 1080 @ 60Hz)
- 1x CDS Interface, Compact PCI Connector
- 2x GbE LAN (Support WoL, Teaming, Jumbo Frame and PXE), RJ45
  - GbE1: Intel I219LM
  - GbE2: Intel I210IT
- 2x PoE+ (with Optional CFM PoE Module)
  - Comply with IEEE 802.3at
  - Individual Port Offers Up to 25.5W
- 6x RS-232/422/485 with Auto Flow Control, DB9
  - Supports 5V/12V Selectable by DIP Switch
- 4x USB 3.0, Type-A
- 1x USB 2.0, Type-A
- 16x Isolated DIO (8x DI/8x DO), 20-Pin Terminal Block
- 1x Line-out & 1x Mic-in, Phone Jack 3.5mm
- 1x Power On/Off Switch
- 1x Reset Button
- 1x AT/ATX Switch
- 1x Remote Power On/Off Connector, 2-Pin Terminal Block
- 1x External FAN Connector, 4-Pin Terminal Block

## Storage

- 2x 2.5" SATA HDD/SSD Bay, Support RAID 0/1 (Gen3)
- 2x mSATA (One Shared by Mini-PCIe Socket) (Gen2)
- 1x CFAST Socket (Gen3)

## Expansion

- 1x CFM PoE interface
- 1x CFM IGN interface
- 2x Full-size Mini-PCIe Socket
- 1x PCI or 1x PCIe4 Socket (For P19R/C-ixSL-RE only)
- 1x Universal I/O Bracket
- 1x SIM Socket
- 4x Antenna Hole

## Other Function

- Support CDS Technology
- Support CFM Technology
- Support Instant Reboot Technology (0.2 sec)
- Support Power Ignition Sensing (IGN)
- Support OSD Function (LCD On/Off, Brightness Up, Brightness Down for CDS Display Module)
- Internal Speaker AMP 2W + 2W
- SuperCap Integrated for CMOS Battery Maintenance-free Operation
- Watchdog Timer: Software Programmable Supports 1~256 Levels System Reset

## Power Requirement

- Support AT/ATX Power Mode
- Power Input Voltage 9~48VDC
- One 3-pin Terminal Block Connector
- Power Adapter AC/DC 12V/5A 60W, 24V/5A 120W or 24V/9.2A 220W (Optional)

## Protection

- Reverse Power Input Protection
- Over Voltage Protection: 58V
- Over Current Protection: 15A
- ESD Protection: +/-15kV (air), +/-8kV (contact)
- Surge Protection: 3.84kW (impedance 12 Ohm 1.2/50µs waveform)

## Operating System

- Windows® 10 / 8.1 / 7
- Linux® Kernel 4.4

Dimensions

PowerTwin P19R/C-ixSL-R

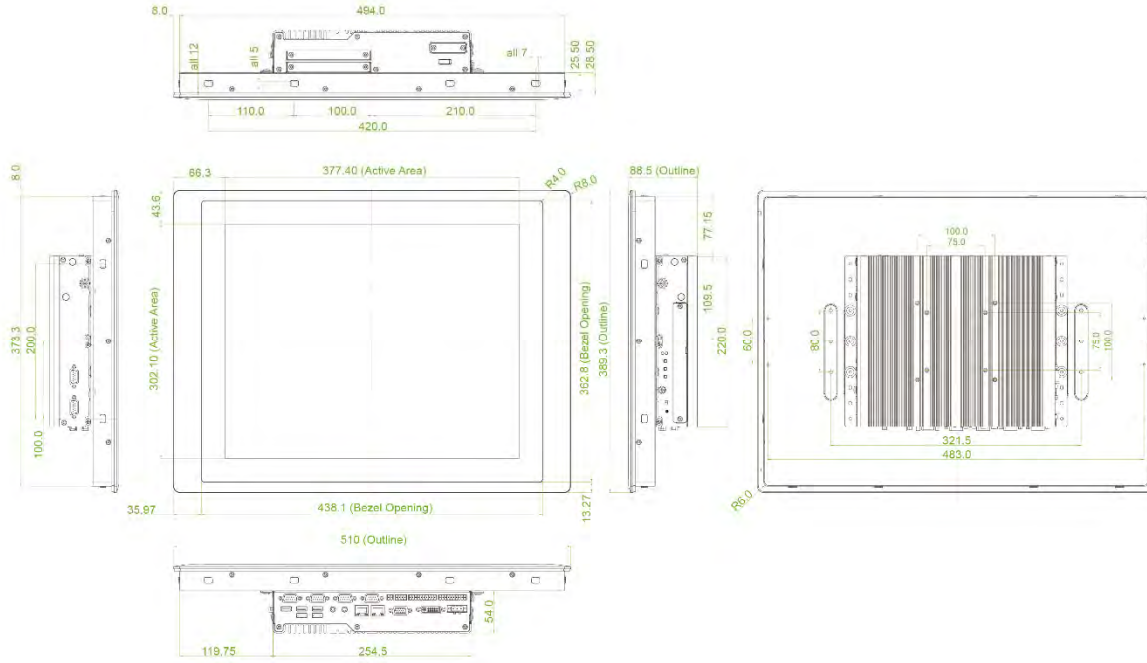

PowerTwin P19R/C-ixSL-RE

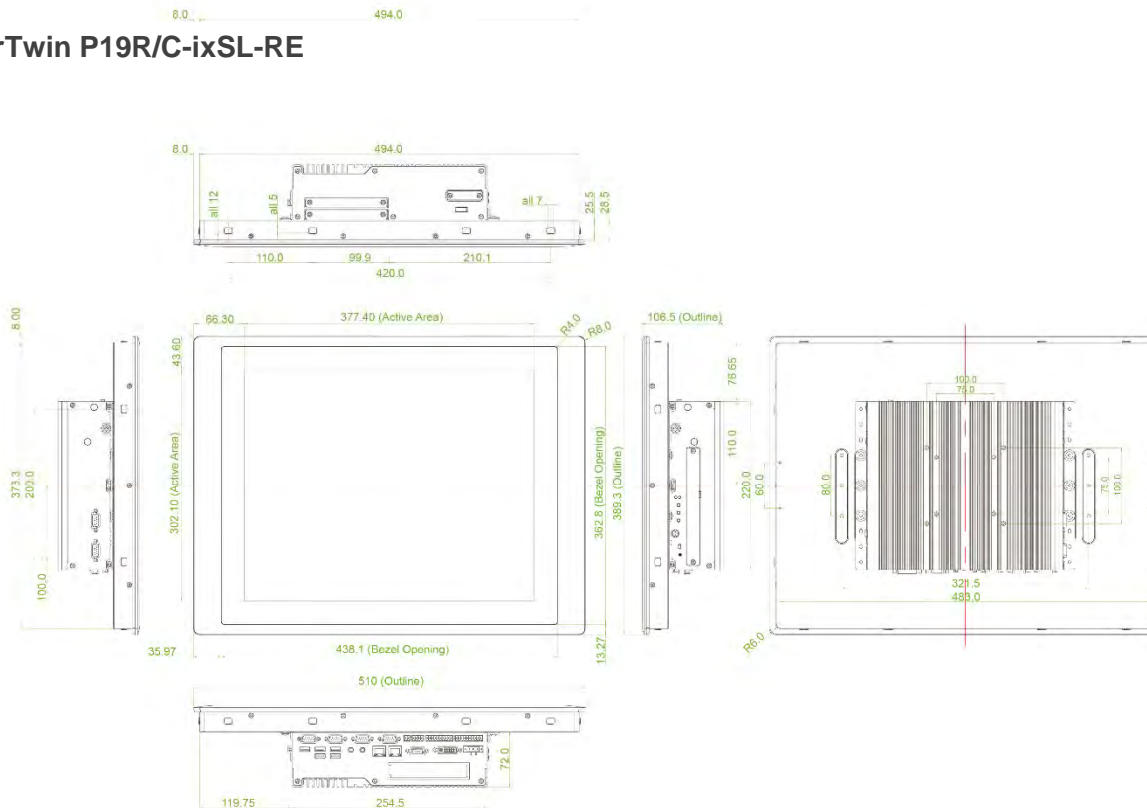

## 1.5.6 PowerTwin PW21R/C-ixSL

### PowerTwin PW21R/C-ixSL-R(E)

#### Display

- LCD Size: 21.5" (16:9)
- Max. Resolution: 1920 x 1080
- Brightness (cd/m2): 300
- Contrast Ratio: 5000 : 1
- LCD Color: 16.7M
- Pixel Pitch (mm): 0.24825 (H) x 0.24825 (V)
- Viewing Angle (H-V): 178 / 178
- Backlight MTBF: 50,000 hrs (LED Backlight)

#### Touch

- Resistive 5-wire Touch for PowerTwin PW21R-ixSL-R(E) Only
- Projected Capacitive Touch for PowerTwin PW21C-ixSL-R(E) Only

#### Physical

- Dimension (WxHxD):
  - PowerTwin PW21R/C-ixSL-R: 550 x 330.5 x 88.5 mm
  - PowerTwin PW21R/C-ixSL-RE: 550 x 330.5 x 106.5 mm
- Weight: :
  - PowerTwin PW21R/C-ixSL-R: 8.48 kg
  - PowerTwin PW21R/C-ixSL-RE: 8.74 kg
- Mechanical Construction: Rugged Aluminum Die-casting Front Bezel and Heavy Duty Metal Chassis
- Mounting: Panel / VESA Mounting / \*Rack Mounting (\*with optional mounting kit)
- Fanless Design
- Jumper-less Design

#### Environment

- Operating Temperature: 0°C to 60°C  
(with extended temperature peripherals; Ambient with air flow;  
According to IEC60068-2-1, IEC60068-2-2, IEC60068-2-14)
- Storage Temperature: -20°C to 60°C
- Relative Humidity:
  - PowerTwin PW21R-ixSL-R(E): 80% RH @ 40°C (Non-Condensing)
  - PowerTwin PW21C-ixSL-R(E): 80% RH @ 40°C (Non-Condensing)
  - PowerTwin PW21-ixSL-R(E): 90% RH @ 40°C (Non-Condensing)
- EMC: CE, FCC Class A

## Processor System

- Onboard 6th Intel® Core™ U processors (Skylake)
  - Intel® Core™ i5-6300U processor (3M Cache, up to 3.00 GHz)
  - Intel® Core™ i3-6100U processor (3M Cache, 2.30 GHz)
  - TDP: 15 W
  - BIOS: AMI 64Mbit SPI BIOS

Or Core-i7-6600U upon request

## Memory

- 2x DDR4 260-pin SO-DIMM socket, support up to 32 GB (2133MHz, un-buffered and non-ECC type)

## Graphics

- Intel® HD Graphics 520
- Triple independent display with 1x VGA, 1x DVI-D and 1x CDS interface

## Audio

- Realtek® ALC888-GR
- High Definition Audio

## I/O Interface

- 1x VGA (Up to 1920 x 1080 @ 60Hz), DB-15
- 1x DVI-D (Up to 1920 x 1080 @ 60Hz)
- 1x CDS Interface, Compact PCI Connector
- 2x GbE LAN (Support WoL, Teaming, Jumbo Frame and PXE), RJ45
  - GbE1: Intel I219LM
  - GbE2: Intel I210IT
- 2x PoE+ (with Optional CFM PoE Module)
  - Comply with IEEE 802.3at
  - Individual Port Offers Up to 25.5W
- 6x RS-232/422/485 with Auto Flow Control, DB9
  - Supports 5V/12V Selectable by DIP Switch
- 4x USB 3.0, Type-A
- 1x USB 2.0, Type-A
- 16x Isolated DIO (8x DI/8x DO), 20-Pin Terminal Block
- 1x Line-out & 1x Mic-in, Phone Jack 3.5mm
- 1x Power On/Off Switch
- 1x Reset Button
- 1x AT/ATX Switch
- 1x Remote Power On/Off Connector, 2-Pin Terminal Block
- 1x External FAN Connector, 4-Pin Terminal Block

## Storage

- 2x 2.5" SATA HDD/SSD Bay, Support RAID 0/1 (Gen3)
- 2x mSATA (One Shared by Mini-PCIe Socket) (Gen2)
- 1x CFAST Socket (Gen3)

## Expansion

- 1x CFM PoE interface
- 1x CFM IGN interface
- 2x Full-size Mini-PCIe Socket
- 1x PCI or 1x PCIe4 Socket (For PW21R/C-ixSL-RE only)
- 1x Universal I/O Bracket
- 1x SIM Socket
- 4x Antenna Hole

## Other Function

- Support CDS Technology
- Support CFM Technology
- Support Instant Reboot Technology (0.2 sec)
- Support Power Ignition Sensing (IGN)
- Support OSD Function (LCD On/Off, Brightness Up, Brightness Down for CDS Display Module)
- Internal Speaker AMP 2W + 2W
- SuperCap Integrated for CMOS Battery Maintenance-free Operation
- Watchdog Timer: Software Programmable Supports 1~256 Levels System Reset

## Power Requirement

- Support AT/ATX Power Mode
- Power Input Voltage 9~48VDC
- One 3-pin Terminal Block Connector
- Power Adapter AC/DC 12V/5A 60W, 24V/5A 120W or 24V/9.2A 220W (Optional)

## Protection

- Reverse Power Input Protection
- Over Voltage Protection: 58V
- Over Current Protection: 15A
- ESD Protection: +/-15kV (air), +/-8kV (contact)
- Surge Protection: 3.84kW (impedance 12 Ohm 1.2/50µs waveform)

## Operating System

- Windows® 10 / 8.1 / 7
- Linux® Kernel 4.4

Dimensions

PowerTwin PW21R/C-ixSL-R

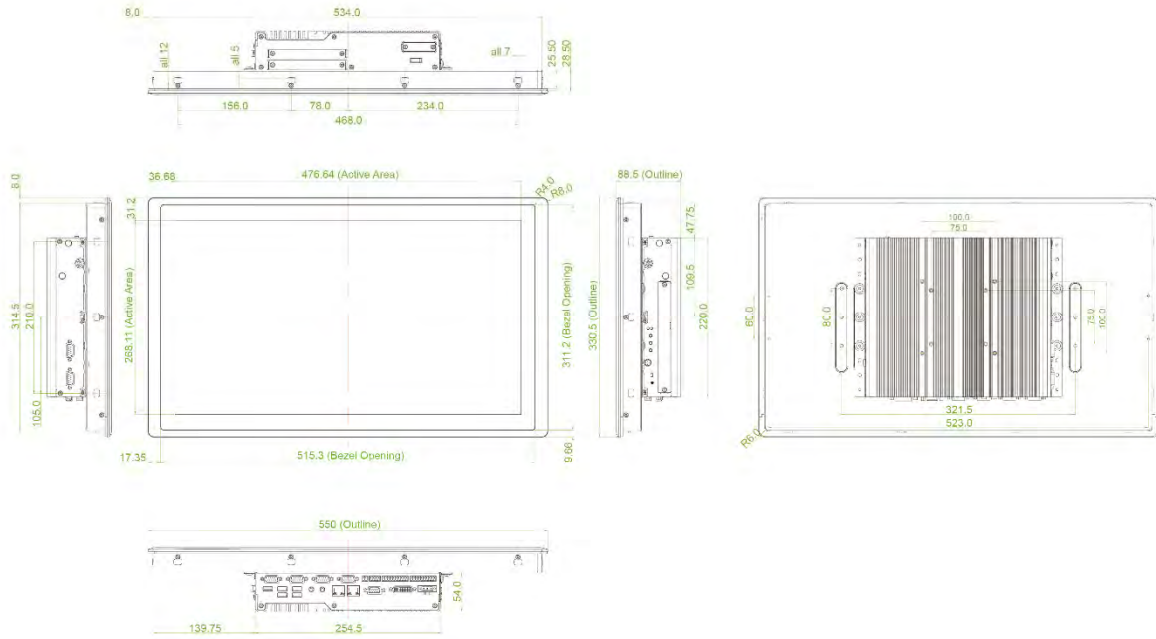

PowerTwin PW21R/C-ixSL-RE

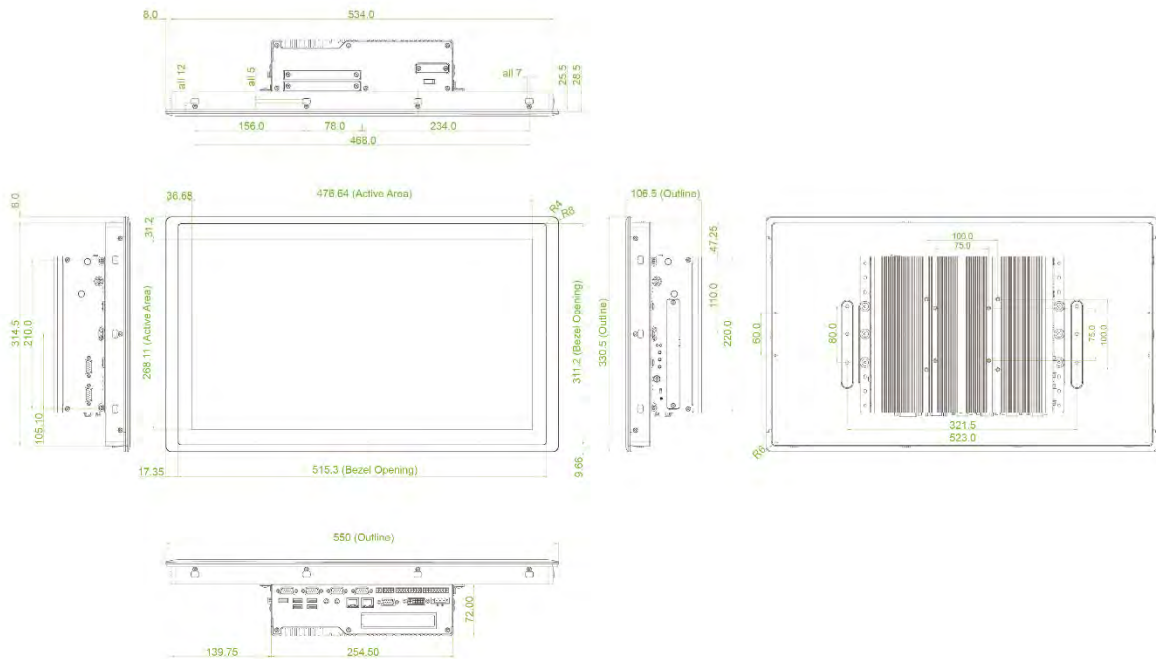

## 1.5.7 PowerTwin PW24R/C-ixSL

### PowerTwin PW24R/C-ixSL-R(E)

#### Display

- LCD Size: 24" (16:9)
- Max. Resolution: 1920 x 1080
- Brightness (cd/m2): 300
- Contrast Ratio: 5000 : 1
- LCD Color: 16.7M
- Pixel Pitch (mm): 0.277 (H) x 0.277 (V)
- Viewing Angle (H-V): 178 / 178
- Backlight MTBF: 50,000 hrs (LED Backlight)

#### Touch

- Resistive 5-wire Touch for PowerTwin PW24R-ixSL-R(E) Only
- Projected Capacitive Touch for PowerTwin PW24C-ixSL-R(E) Only

#### Physical

- Dimension (WxHxD):
  - PowerTwin PW24R/C-ixSL-R: 605 x 373 x 88.5 mm
  - PowerTwin PW24R/C-ixSL-RE: 605 x 373 x 106.5 mm
- Weight: :
  - PowerTwin PW24R-ixSL-R: 9.84 kg
  - PowerTwin PW24R-ixSL-RE: 10.10 kg
  - PowerTwin PW24C-ixSL-R: 9.56 kg
  - PowerTwin PW24C-ixSL-RE: 9.82 kg
- Mechanical Construction: Rugged Aluminum Die-casting Front Bezel and Heavy Duty Metal Chassis
- Mounting: Panel / VESA Mounting / \*Rack Mounting (\*with optional mounting kit)
- Fanless Design
- Jumper-less Design

#### Environment

- Operating Temperature:
  - PowerTwin PW24R-ixSL-R(E): -10°C to 60°C
  - PowerTwin PW24C-ixSL-R(E)C: -20°C to 70°C
  - PowerTwin PW24-ixSL-R(E): -20°C to 70°C(with extended temperature peripherals; Ambient with air flow; According to IEC60068-2-1, IEC60068-2-2, IEC60068-2-14)
- Storage Temperature:
  - PowerTwin PW24R-ixSL-R(E): -20°C to 70°C
  - PowerTwin PW24C-ixSL-R(E) : -30°C to 80°C
  - PowerTwin PW24-ixSL-R(E) : -30°C to 80°
- Relative Humidity: 80% RH @ 50°C (Non-condensing)
- IP Level: IP65 Compliant Front Panel
- EMC: CE, FCC Class A



## Processor System

- Onboard 6th Intel® Core™ U processors (Skylake)
  - Intel® Core™ i5-6300U processor (3M Cache, up to 3.00 GHz)
  - Intel® Core™ i3-6100U processor (3M Cache, 2.30 GHz)
  - TDP: 15 W
  - BIOS: AMI 64Mbit SPI BIOS

Or Core-i7-6600U upon request

## Memory

- 2x DDR4 260-pin SO-DIMM socket, support up to 32 GB (2133MHz, un-buffered and non-ECC type)

## Graphics

- Intel® HD Graphics 520
- Triple independent display with 1x VGA, 1x DVI-D and 1x CDS interface

## Audio

- Realtek® ALC888-GR
- High Definition Audio

## I/O Interface

- 1x VGA (Up to 1920 x 1080 @ 60Hz), DB-15
- 1x DVI-D (Up to 1920 x 1080 @ 60Hz)
- 1x CDS Interface, Compact PCI Connector
- 2x GbE LAN (Support WoL, Teaming, Jumbo Frame and PXE), RJ45
  - GbE1: Intel I219LM
  - GbE2: Intel I210IT
- 2x PoE+ (with Optional CFM PoE Module)
  - Comply with IEEE 802.3at
  - Individual Port Offers Up to 25.5W
- 6x RS-232/422/485 with Auto Flow Control (Support 5V/12V), DB9
- 4x USB 3.0, Type-A
- 1x USB 2.0, Type-A
- 16x Isolated DIO (8x DI/8x DO), 20-Pin Terminal Block
- 1x Line-out & 1x Mic-in, Phone Jack 3.5mm
- 1x Power On/Off Switch
- 1x Reset Button
- 1x AT/ATX Switch
- 1x Remote Power On/Off Connector, 2-Pin Terminal Block
- 1x External FAN Connector, 4-Pin Terminal Block

## Storage

- 2x 2.5" SATA HDD/SSD Bay, Support RAID 0/1 (Gen3)
- 2x mSATA (One Shared by Mini-PCIe Socket) (Gen2)
- 1x CFAST Socket (Gen3)

## Expansion

- 1x CFM PoE interface
- 1x CFM IGN interface
- 2x Full-size Mini-PCIe Socket
- 1x PCI or 1x PCIe4 Socket (PW24R/C-ixSL-RE only)

Optional Riser Card: 1x PCI, 1x PCIe4

Support maximum dimension of add-on card

(H x L): 100mm x 200mm

- 1x Universal I/O Bracket
- 1x SIM Socket
- 4x Antenna Hole

## Other Function

- Support CDS Technology
- Support CFM Technology
- Support Instant Reboot Technology (0.2 sec)
- Support Power Ignition Sensing (IGN)
- Support OSD Function (LCD On/Off, Brightness Up, Brightness Down for CDS Display Module)
- Internal Speaker AMP 2W + 2W
- SuperCap Integrated for CMOS Battery Maintenance-free Operation
- Watchdog Timer: Software Programmable Supports 1~256 Levels System Reset

## Power Requirement

- Support AT/ATX Power Mode
- Power Input Voltage 9~48VDC
- One 3-pin Terminal Block Connector
- Power Adapter AC/DC 12V/5A 60W, 24V/5A 120W or 24V/9.2A 220W (Optional)

## Protection

- Reverse Power Input Protection
- Over Voltage Protection: 58V
- Over Current Protection: 15A
- ESD Protection: +/-15kV (air), +/-8kV (contact)
- Surge Protection: 3.84kW (impedance 12 Ohm 1.2/50µs waveform)

## Operating System

- Windows® 10 / 8.1 / 7
- Linux® Kernel 4.4

Dimensions

PowerTwin PW24R/C-ixSL-R

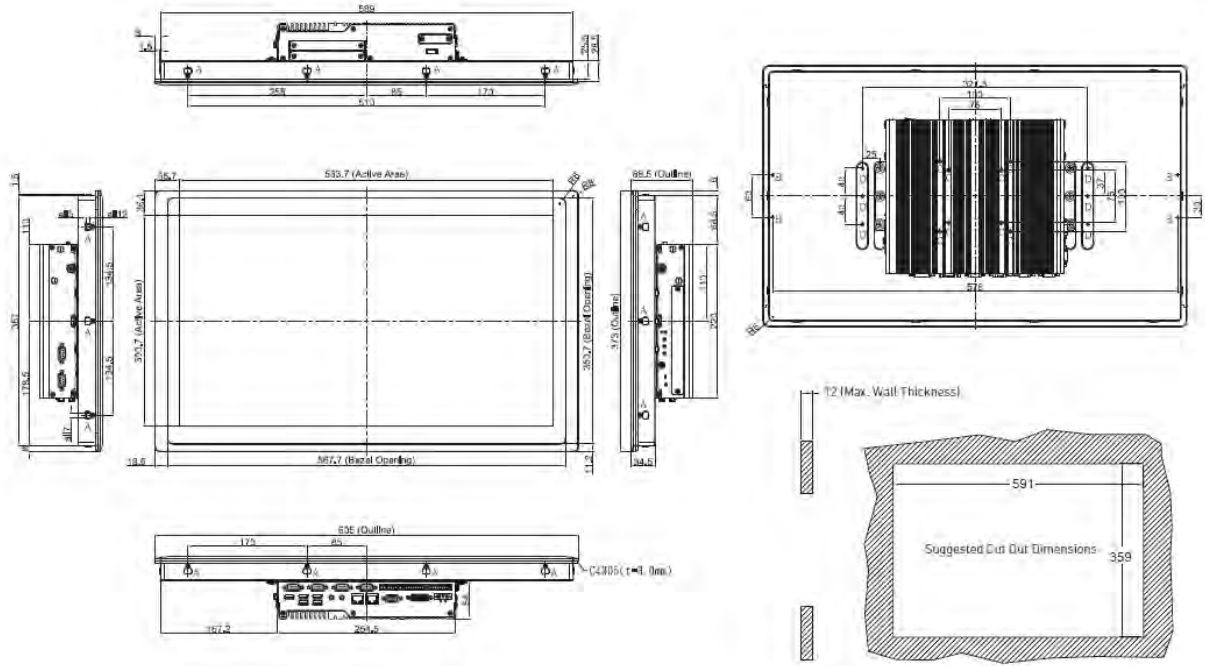

PowerTwin PW24R/C-ixSL-RE

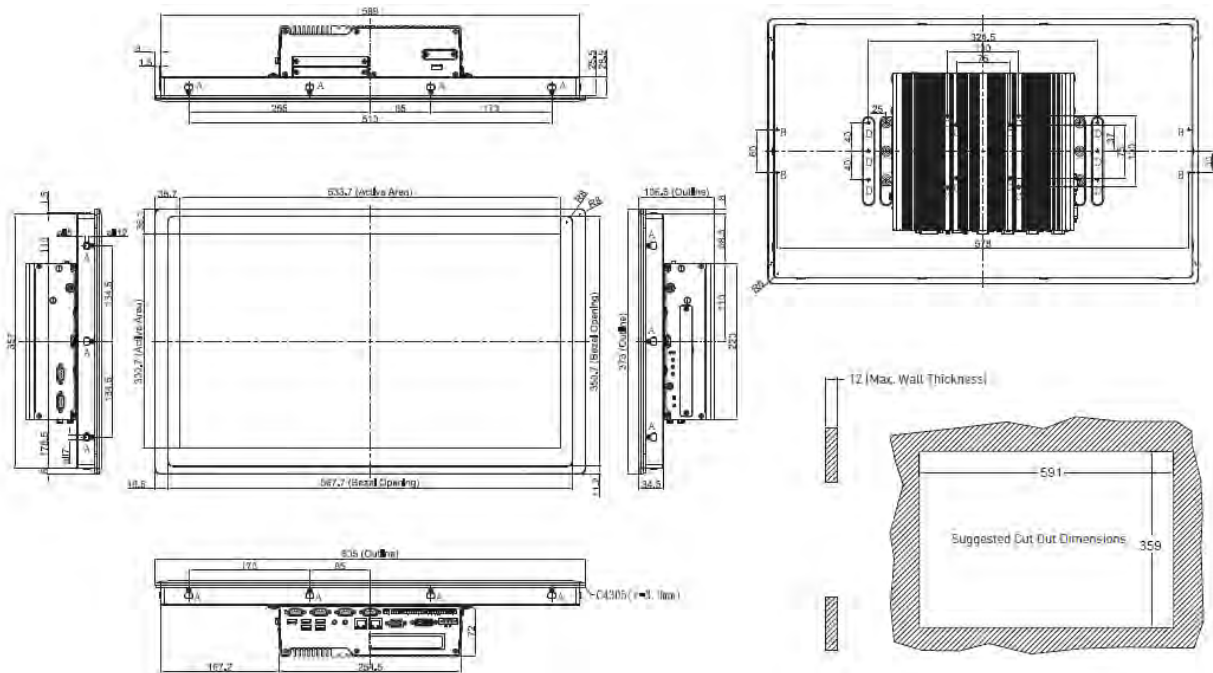

## 1.6 System I/O

### 1.6.1 Front

#### DC IN

Used to plug a DC power input with terminal block

#### DVI-D

Used to connect to an monitor with digital signal interface

#### VGA

Used to connect to an monitor with analog signal interface

#### LAN

Used to connect to local area network

#### Line-out

Used to connect to a external speaker

#### Mic-in

Used to connect to a microphone

#### USB 3.0

Used to connect to USB 3.0/2.0/1.1 compatible devices

#### USB 2.0

Used to connect to USB 2.0/1.1 compatible devices

#### Digital I/O Terminal Block

The Digital I/O terminal block supports 16 isolated DIO (8 digital input and 8 digital output)

#### Fan Power Terminal Block

Used to connect to an external fan

#### SW: Remote Power On/Off Terminal Block

Used to connect to remote power on/off switch

#### COM

Used to connect to RS-232/422/485 serial devices

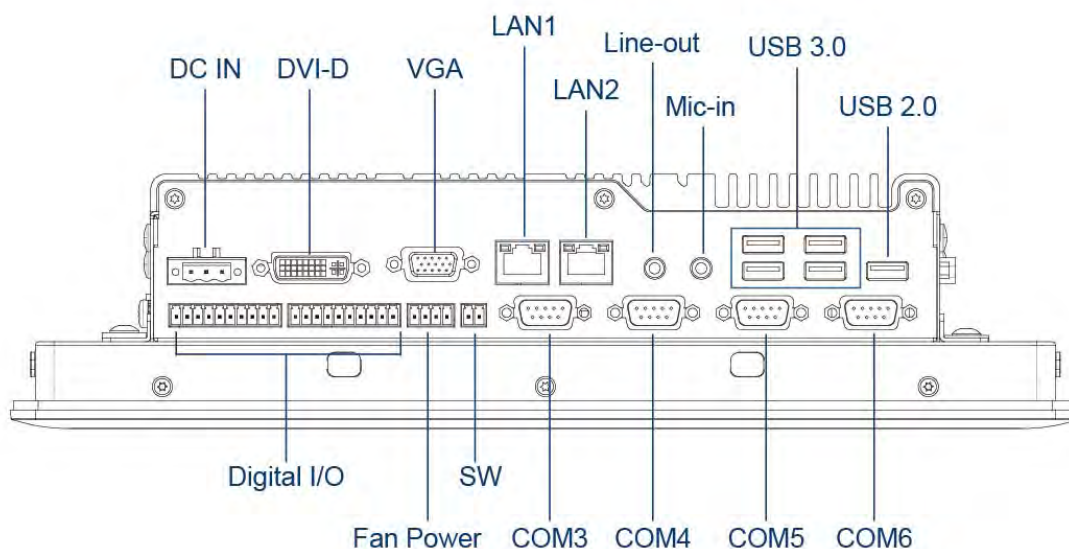

## 1.6.2 Rear

### CFast and SIM Card

CFast card and SIM card slot

### Power On/Off Switch

Power-on or power-off the system

### HDD/SSD

2.5" SATA HDD/SSD Bay, Support RAID 0/1

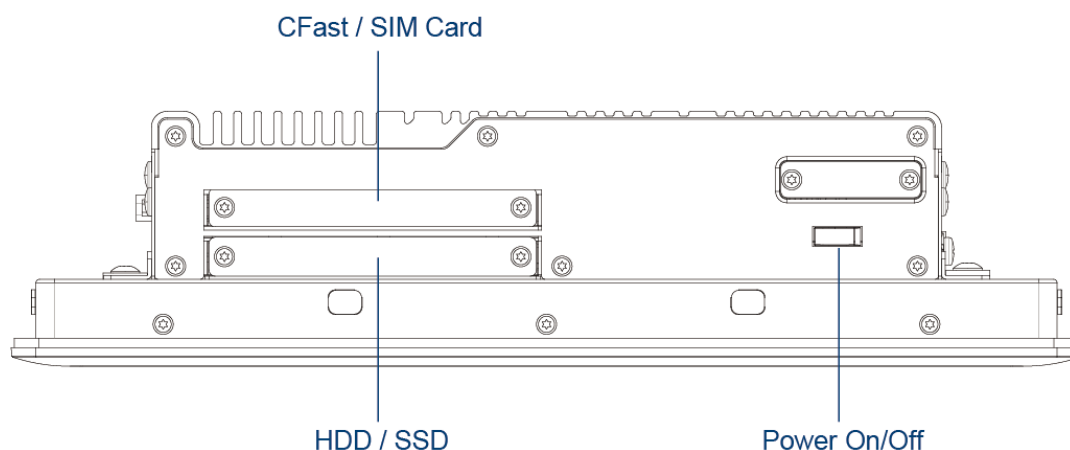

## 1.6.3 Left

### Antenna Hole

Used to connect an antenna for optional Mini-PCIe WiFi module

### Power LED

Indicates the power status of the system

### Universal I/O Bracket

Used to expand I/O for Mini-PCIe module

### HDD LED

Indicates the status of the hard disk drive

### AT/ATX Switch

Used to select AT or ATX power mode

### OSD Function (For CDS Display Module)

- **LCD On/Off**  
Press to turn-on or turn-off the backlight of display
- **Increase Brightness**  
Press to increase brightness of the screen
- **Decrease Brightness**  
Press to decrease brightness of the screen

### Reset Button

Used to reset the system

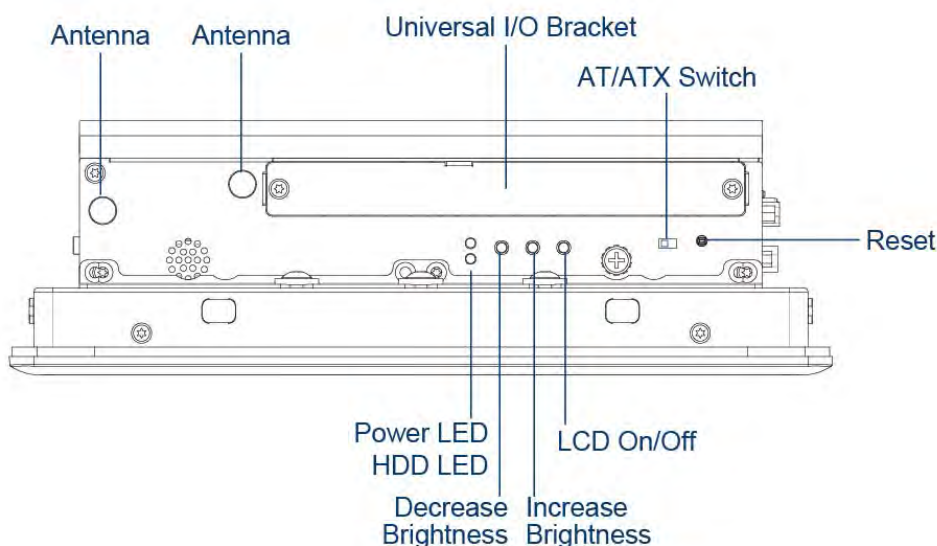

## 1.6.4 Right

### Antenna Hole

Used to connect an antenna for optional Mini-PCle WiFi module

### COM

Used to connect to RS-232/422/485 serial devices

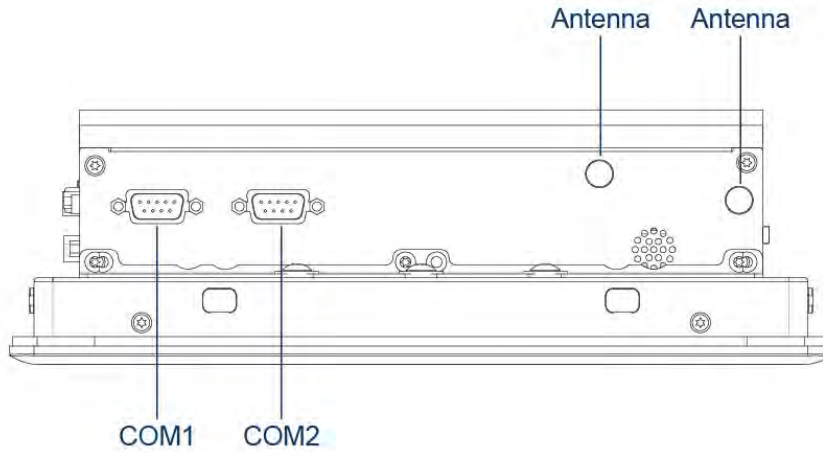

## 1.6.5 Top

### VESA Mounting Hole

These are mounting holes for VESA mount (75x75mm and 100x100mm)

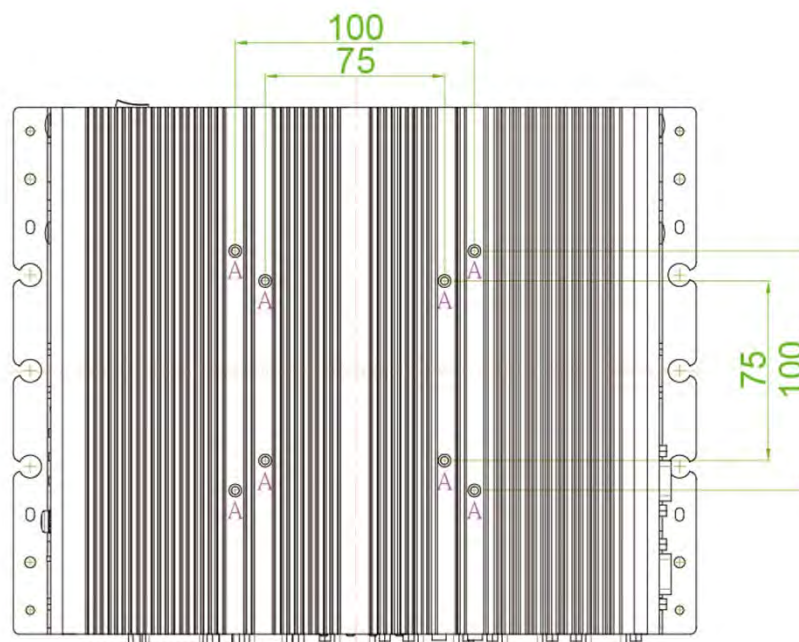

Chapter 2

# Jumpers, Switches & Connectors

## 2.1 Jumpers Settings

When setting the jumpers, ensure that the jumper caps are placed on the correct pins. When the jumper cap is placed on both pins, the jumper is **short**. If you remove the jumper cap, or place the jumper cap on just one pin, the jumper is **open**. Refer to below for examples of the 2-pin and 3-pin jumpers when they are short (on) and open (off).

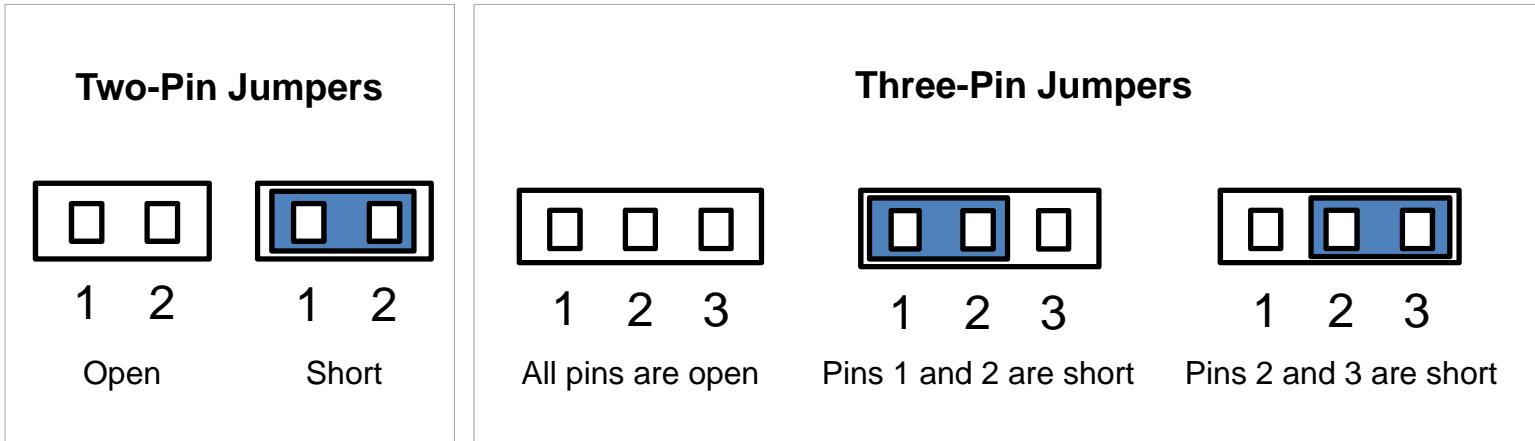

## 2.2 Location of Jumpers, Switches and Connectors

### 2.2.1 Top View

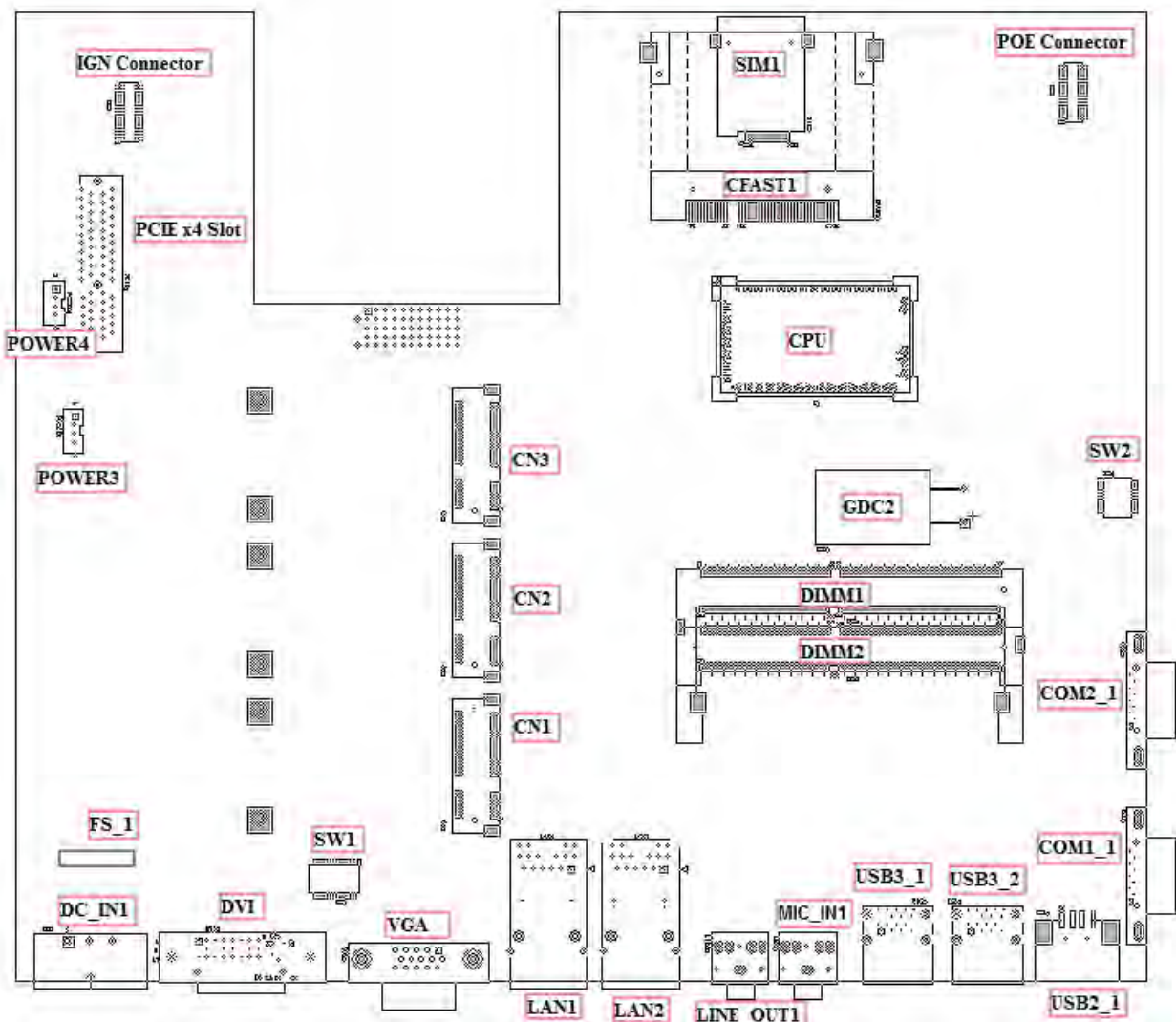

## 2.2.2 Bottom View

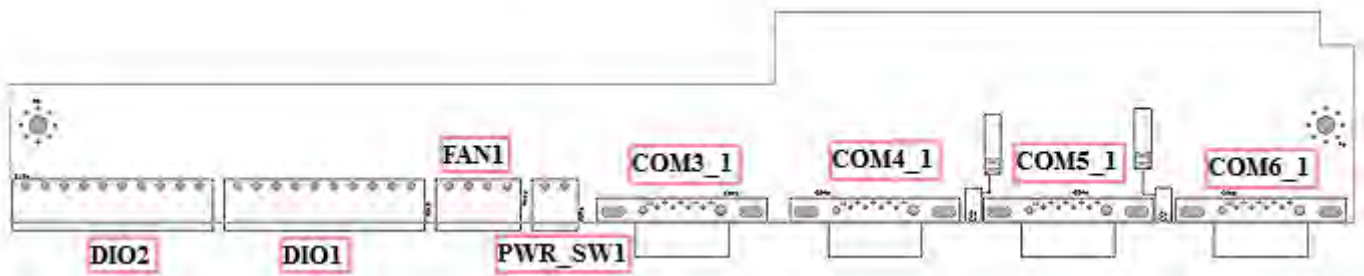
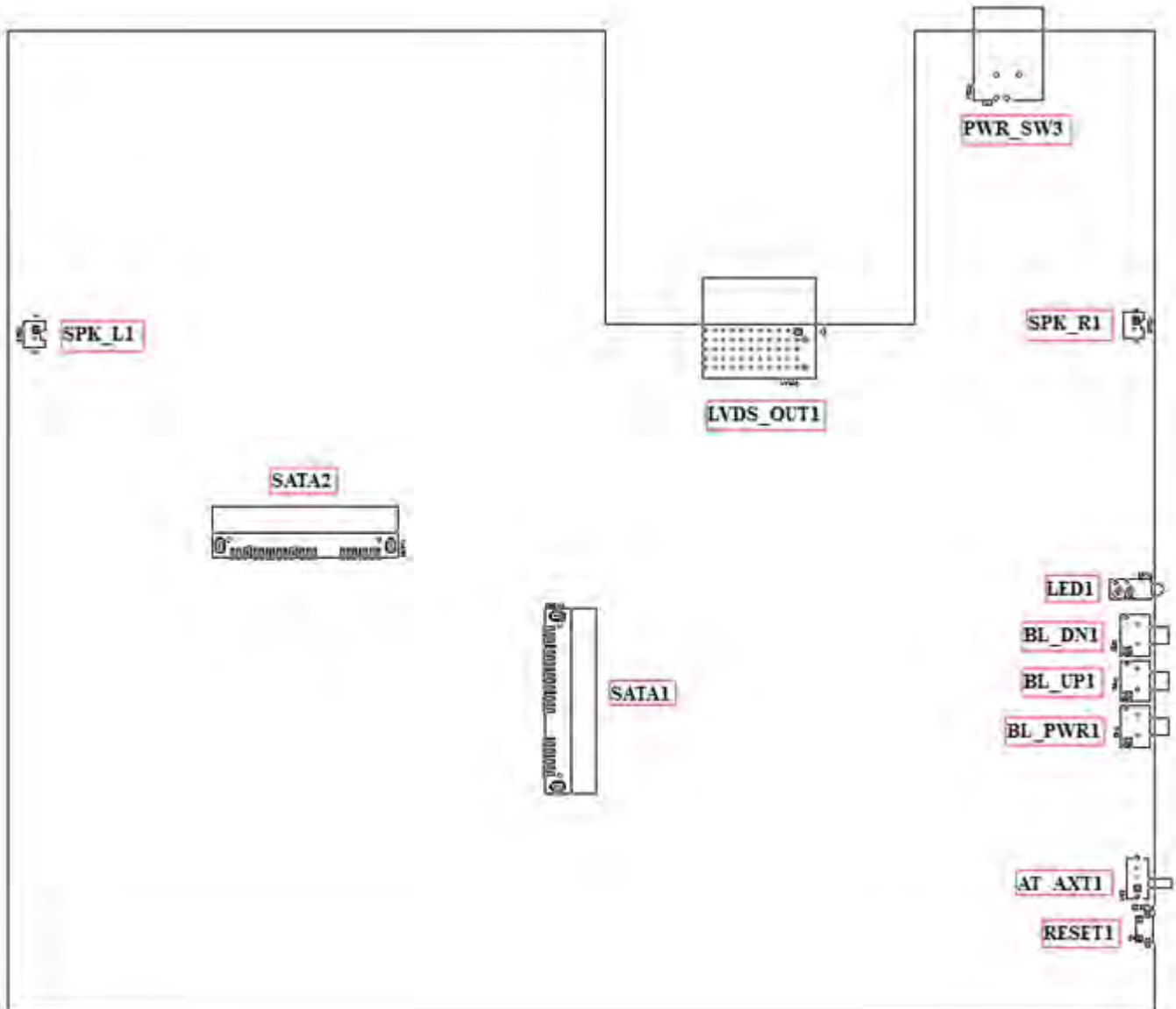



## 2.3 List of Jumpers, Switches and Connectors

Connector Location	Definition
AT_ATX1	AT / ATX Power Mode Switch
BL_PWR1	Backlight Power on / off switching
BL_UP1	Backlight Increase
BL_DN1	Backlight Decrease
CFAST1	CFast Connector
SW1	COM3~6 with Power Select
COM1_1, COM2_1, COM3_1 COM4_1, COM5_1, COM6_1	RS232 / RS422 / RS485 Connector
SW2	Function setting
DC_IN1	3-pin DC 9~48V Power Input Connector
FS_1	Fuse
DVI_I1	DVI-D Connector
LAN1 \ LAN2	LAN Port
LED1	Power / HDD Access LED Status
LINE_OUT1	Line-out Jack
MIC_IN1	Mic-in Jack
CN1	Mini PCI-Express Socket
CN2	Mini PCI-Express Socket/ MSATA Select Socket
CN3	MSATA Socket
POWER3 \ POWER4	+5V/ +12V Power Output
PWR_SW3	Power Switch Connector
RESET1	Reset Switch
SATA1 \ SATA2	SATA with Power Connector
SIM1	SIM Card Socket
SPK_L1 \ SPK_R1	Internal Speaker Connector
USB2_1	USB 2.0 Port
USB3_1 \ USB3_2	USB 3.0 Port
VGA1	VGA Connector
PWR_SW1	Power Switch Connector
FAN1	FAN Increase
DIO1	DIO Connector
DIO2	DIO Connector
PCIE1	PCIE Connector

## 2.4 Definition of Switches

### Super CAP Function Setting: Pin Define SW2 Switch

Switch mode	Function	ON	OFF
1	Super CAP	Enable <b>(Default)</b>	Disable

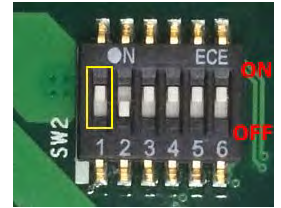

### Clear CMOS Function Setting : Pin Define SW2 Switch

Switch mode	Function	ON	OFF
2	CMOS	Clear CMOS	Normal <b>(Default)</b>

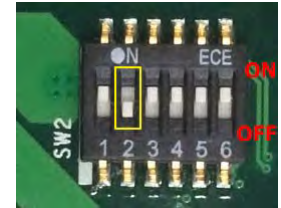

### COM1/2 Voltage Function Setting : Pin Define SW2 Switch

Switch mode	Function		ON	OFF
3-4	COM2	0V	ON/ON <b>(Default)</b>	
		5V	ON/OFF	
		12V	OFF/OFF	
5-6	COM1	0V	ON/ON <b>(Default)</b>	
		5V	ON/OFF	
		12V	OFF/OFF	

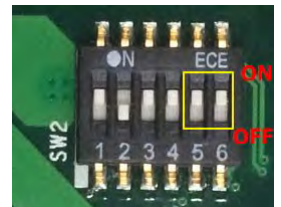
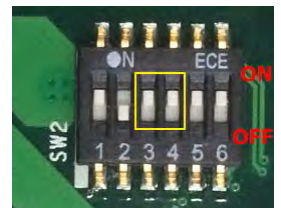

### COM3/4/5/6 Voltage Function Setting : Pin Define SW1 Switch

Switch mode	Function		ON	OFF
1-2	COM3	0V	ON/ON (Default)	
		5V	ON/OFF	
		12V	OFF/OFF	
3-4	COM4	0V	ON/ON (Default)	
		5V	ON/OFF	
		12V	OFF/OFF	

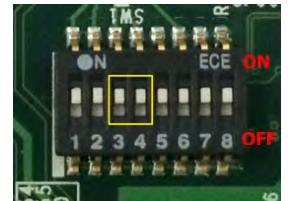
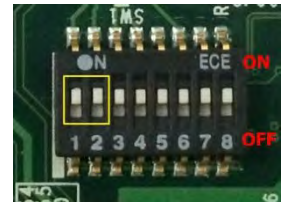

5-6	COM5	0V	ON/ON (Default)	
		5V	ON/OFF	
		12V	OFF/OFF	
7-8	COM6	0V	ON/ON (Default)	
		5V	ON/OFF	
		12V	OFF/OFF	

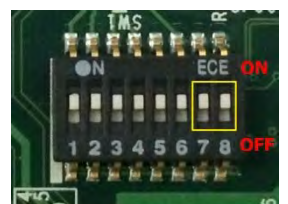
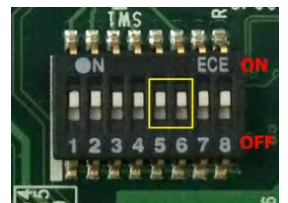

### AT\_ATX1: AT / ATX Power Mode Switch



Switch	Definition
1-2 (Left)	AT Power Mode
2-3 (Right)	ATX Power Mode ( Default )

### BL\_PWR1: Backlight Power on / off

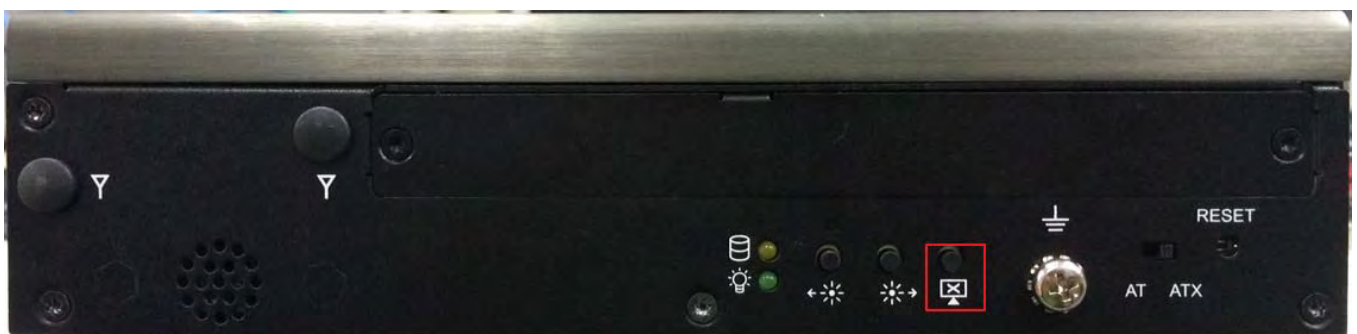

Switch	Definition
Push	Backlight Power on / off switching

### BL\_UP1: Backlight Increase



Switch	Definition
Push	Backlight Increase

### BL\_DN1: Backlight Decrease



Switch	Definition
Push	Backlight Decrease

### RESET1: Reset Switch



Switch	Definition
Push	Reset System

## 2.5 Definition of Connectors

### CFAST1: CFast Connector

Pin	Definition	Pin	Definition	Pin	Definition
S1	GND	PC1	NC	PC10	NC
S2	SATA_TX2+	PC2	GND	PC11	NC
S3	SATA_TX2-	PC3	NC	PC12	NC
S4	GND	PC4	NC	PC13	+3.3V
S5	SATA_RX2-	PC5	NC	PC14	+3.3V
S6	SATA_RX2+	PC6	NC	PC15	GND
S7	GND	PC7	GND	PC16	GND
		PC8	NC	PC17	NC
		PC9	NC		

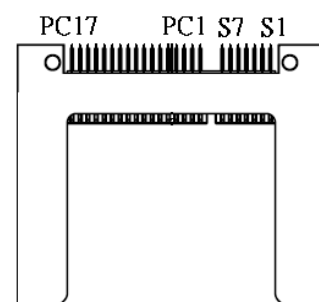

### SIM1 : SIM Card Socket

Pin	Definition
C1	UIM_PWR
C2	UIM_RESET
C3	UIM_CLK
C5	GND
C6	UIM_VPP
C7	UIM_DATA
CD	NC
COM	GND

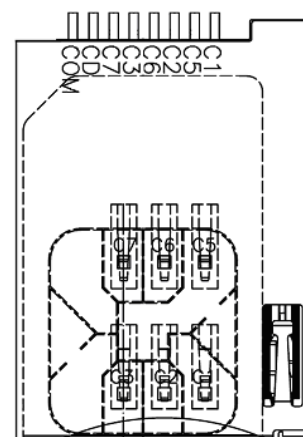

**COM1\_1/COM2\_1/(COM3\_1/COM4\_1/COM5\_1/COM6\_1 in the BTB Board): RS232 / RS422 / RS485 Connector**

Connector Type: 9-pin D-Sub



DB9 Pin	RS232 Definition	RS422 / 485 Full Duplex Definition	RS485 Half Duplex Definition
1	DCD	TX-	DATA-
2	RXD	TX+	DATA+
3	TXD	RX+	
4	DTR	RX-	
5	GND		
6	DSR		
7	RTS		
8	CTS		
9	RI		

### DC\_IN1: DC Power Input Connector (+9~48V)

Connector Type: Terminal Block 1X3 3-pin, 5.0mm pitch

Pin	Definition
1	+9~48VIN
2	Ignition (IGN)
3	GND





### LAN1/LAN2: RJ45 with LEDs Port

Pin	Definition	Pin	Definition
1	LAN1_MDI0P	5	LAN1_MDI2N
2	LAN1_MDI0N	6	LAN1_MDI1N
3	LAN1_MDI1P	7	LAN1_MDI3P
4	LAN1_MDI2P	8	LAN1_MDI3N



Act LED Status	Definition	Link LED Status	Definition
Blinking Yellow	Data Activity	Steady Green	1Gbps Network Link
Off	No Activity	Steady Orange	100Mbps Network Link
		Off	10Mbps Network Link

### LED1: Power / HDD Access LED Status

LED Status	LED Color
HDD	Yellow
POWER	Green

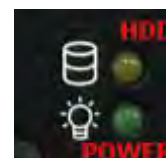

### LINE\_OUT1: Line-out Jack (Green)

Connector Type: 5-pin Phone Jack

Pin	Definition
1	GND
2	OUT_R
3	NC
4	GND
5	OUT_L



### MIC1: Microphone Jack (Pink)

Connector Type: 5-pin Phone Jack

Pin	Definition
1	GND
2	MIC_R
3	NC
4	GND
5	MIC_L

### CN1: Mini PCI-Express Socket (SIM Card to Link)

Pin	Definition	Pin	Definition	Pin	Definition
1	WAKE#	19	NA	37	RESERVED
2	+3.3V	20	+3.3V	38	USB_D+
3	NA	21	GND	39	RESERVED
4	GND	22	PERST#	40	GND
5	NA	23	PERN0	41	+3.3V
6	+1.5V	24	+3.3V	42	NA
7	CLKREQ#	25	PERN0	43	GND
8	RESERVED	26	GND	44	NA
9	GND	27	GND	45	NA
10	SIM_DATA	28	+1.5V	46	NA
11	REFCLK+	29	GND	47	NA
12	SIM_CLK	30	SMB_CLK	48	+1.5V
13	REFCLK+	31	PETN0	49	NA
14	SIM_RESET	32	SMB_DATA	50	GND
15	GND	33	PETP0	51	NA
16	SIM_VPP	34	GND	52	+3.3V
17	NA	35	GND		
18	GND	36	USB_D-		

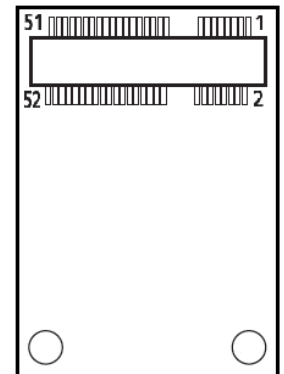

## CN2: Mini PCI-Express Socket / mSATA Socket

Pin	Definition	Pin	Definition	Pin	Definition
1	WAKE#	19	NA	37	GND
2	+3.3V	20	+3.3V	38	USB_D+
3	NA	21	GND	39	+3.3V
4	GND	22	PERST#	40	GND
5	NA	23	PERN0/SATAPR0	41	+3.3V
6	+1.5V	24	+3.3VAUX	42	NA
7	CLKREQ#	25	PERN0/SATARN0	43	GND
8	NA	26	GND	44	NA
9	GND	27	GND	45	NA
10	NA	28	+1.5V	46	NA
11	REFCLK+	29	GND	47	NA
12	NA	30	SMB_CLK	48	+1.5V
13	REFCLK+	31	PETN0	49	NA
14	NA	32	SMB_DATA	50	GND
15	GND	33	PETP0	51	NA
16	NA	34	GND	52	+3.3V
17	NA	35	GND		
18	GND	36	USB_D-		

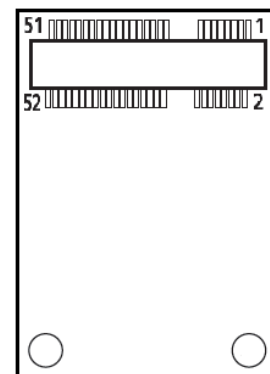

### CN3: mSATA Socket

Pin	Definition	Pin	Definition	Pin	Definition
1	WAKE#	19	NA	37	GND
2	+3.3V	20	+3.3V	38	USB_D+
3	NA	21	GND	39	+3.3V
4	GND	22	PERST#	40	GND
5	NA	23	SATARXP	41	+3.3V
6	+1.5V	24	+3.3V	42	NA
7	NA	25	SATARXN	43	GND
8	NA	26	GND	44	NA
9	GND	27	GND	45	NA
10	NA	28	+1.5V	46	NA
11	NA	29	GND	47	NA
12	NA	30	SMB_CLK	48	+1.5V
13	NA	31	SATATXN	49	NA
14	NA	32	SMB_DATA	50	GND
15	GND	33	SATATXP	51	NA
16	NA	34	GND	52	+3.3V
17	NA	35	GND		
18	GND	36	USB_D-		

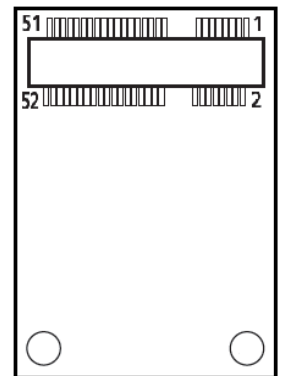

### POWER3: Power Connector

Connector Type: 1X4-pin Wafer, 2.0mm pitch

Pin	Definition
1	+5V
2	GND
3	GND
4	+12V



### POWER4: Power Connector

Connector Type: 1X4-pin Wafer, 2.0mm pitch

Pin	Definition
1	+5V
2	GND
3	GND
4	+12V

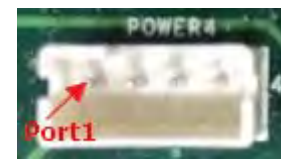

### SATA1/SATA2: SATA with Power Connector

Pin	Definition	Pin	Definition
1	GND	12	GND
2	SATA_TX+	13	GND
3	SATA_TX-	14	+5V
4	GND	15	+5V
5	SATA_RX-	16	+5V
6	SATA_RX+	17	GND
7	GND	18	GND
8	+3.3V	19	GND
9	+3.3V	20	+12V
10	+3.3V	21	+12V
11	GND	22	+12V

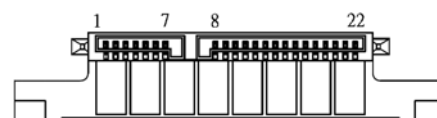

### SPK\_L1: Left Internal Speaker Connector

Pin	Definition
1	OUT_L
2	GND



### SPK\_R1: Right Internal Speaker Connector

Pin	Definition
1	OUT_R
2	GND



### USB2\_1: USB2.0 Connector, Type A

Pin	Definition
1	+5V
2	USB2_DATA1-
3	USB2_DATA1+
4	GND

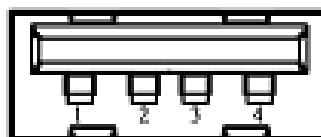

USB 3.0

USB 2.0

### USB3\_1 \ USB3\_2 : USB 3.0 Connector, Type A

Pin	Definition	Pin	Definition
1	+5V	6	USB3_RX0+
2	USB2_D0-	7	GND
3	USB2_D0+	8	USB3_TX0-
4	GND	9	USB3_TX0+
5	USB3_RX0-		

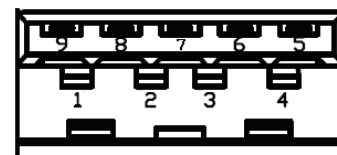



### PWE\_SW1: On / Off Switch

Pin	Definition
1	PWR_SW
2	GND

### FAN1: External PWM Fan Connector

Connector Type: Terminal Block 1X3 3-pin, 3.5mm pitch

Pin	Definition
1	GND
2	+12V
3	SENSE
4	Control

### DIO1(Out): Digital Input / Output Connector

Connector Type: Terminal Block 1X10 10-pin, 3.5mm pitch

Pin	Definition	Pin	Definition
1	XCOM+_1	6	OUT5_1
2	OUT1_1	7	OUT6_1
3	OUT2_1	8	OUT7_1
4	OUT3_1	9	OUT8_1
5	OUT4_1	10	XCOM-_1



### DIO2(IN): Digital Input / Output Connector

Connector Type: Terminal Block 1X10 10-pin, 3.5mm pitch

Pin	Definition	Pin	Definition
1	XCOM+_1	6	IN5_1
2	IN1_1	7	IN6_1
3	IN2_1	8	IN7_1
4	IN3_1	9	IN8_1
5	IN4_1	10	XCOM-_1

## Power Ignition Setting (CFM-IGN100 Only)

Connector Location	Definition
SW2	Ignition Function Setting
24V_12V_1	24V/ 12V Power Switching for Ignition Board

## IGN Board Pin define (CFM-IGN100 Only)

**SW2: Set shutdown delay timer when ACC is turned off**

Pin 1	Pin 2	Pin 3	Pin 4	Definition
OFF / ON	LOW	LOW	LOW	0 second
	LOW	LOW	HIGH	60 seconds
	LOW	HIGH	LOW	10 minutes
	LOW	HIGH	HIGH	30 minutes
	HIGH	LOW	LOW	1 hour
	HIGH	LOW	HIGH	2 hours
	HIGH	HIGH	LOW	Reserved
	HIGH	HIGH	HIGH	Reserved



## 12V\_24V\_1: 12V / 24V Car Battery Switch

Pin	Definition
1-2	24V Car Battery Input
2-3	12V Car Battery Input





Chapter 3

# System Setup

## 3.1 Removing the Top Cover



**WARNING**

In order to prevent electric shock or system damage, before removing the chassis cover, must turn off power and disconnect the unit from power source.

1. Loosen the six screws at front and rear panel.



2. Raise the left edge of top cover(1) , and raise the other side (2) subsequently to remove it from the chassis.



3. Place the top cover aside gently.



## 3.2 Installing a Half Size Mini PCIe Card

1. Locate the Mini PCIe socket on the system board.



2. Use two screws provided on adapter bracket to fasten the card and bracket together.



3. Tilt the Mini PCIe card at a 45-degree angle and insert it into the socket until the golden finger connector of the card seated firmly.

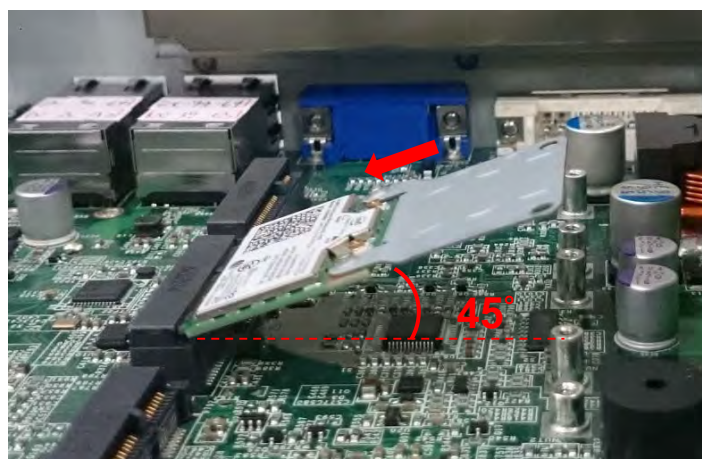

4. Press down the card and secure it with two screws.

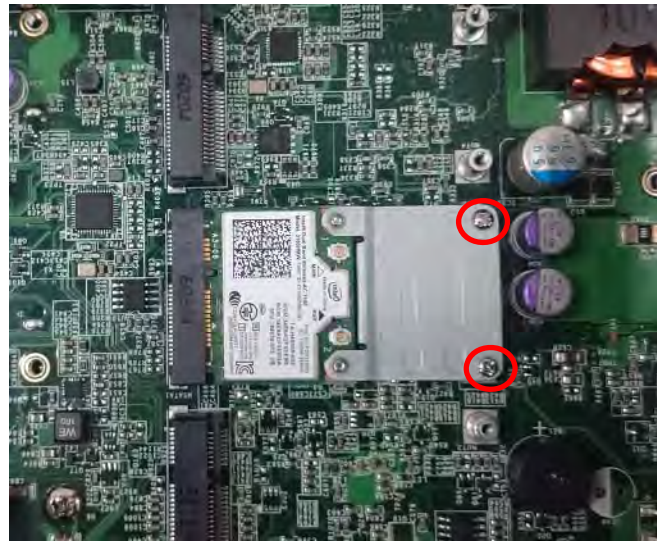

### 3.3 Installing a Full Size Mini PCIe Card

1. Locate the Mini PCIe slot on the system board.



2. Tilt the Mini PCIe card at a 45-degree angle and insert it to the socket until the golden finger connector of the card seated firmly.



3. Press the card down and secure it with 2 screws.



### 3.4 Installing a mSATA Card

1. Locate the mSATA slot on the system board.



2. Tilt the mSATA card at a 45-degree angle and insert it to the socket until the golden finger connector of the card seated firmly.

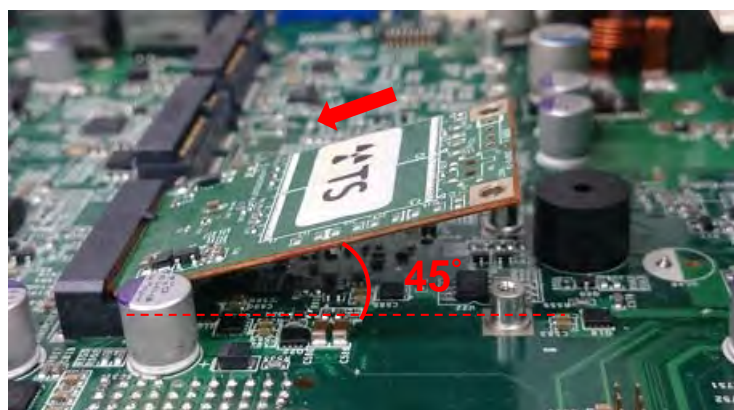

3. Fasten the card with two screws.



### 3.5 Installing Antennas

1. Remove the antenna rubber covers on left and right panel.



2. Penetrate the antenna jack through the hole.



3. Put on the washer and fasten the nut with antenna jack.



4. Assemble the antenna and antenna jack together.



5. Attach the RF connector at the other end of the cable onto the card.

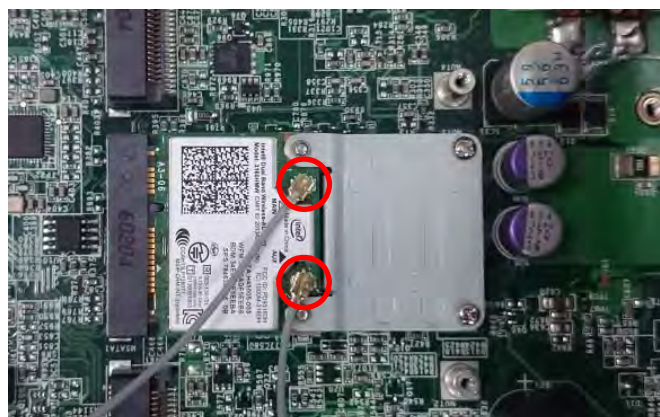

## 3.6 Installing a SO-DIMM Module

1. Locate the SO-DIMM socket on the system board.



2. Tilt the memory module at a 45-degree angle, and insert it into SO-DIMM socket until the golden finger connector of the module is seated firmly.

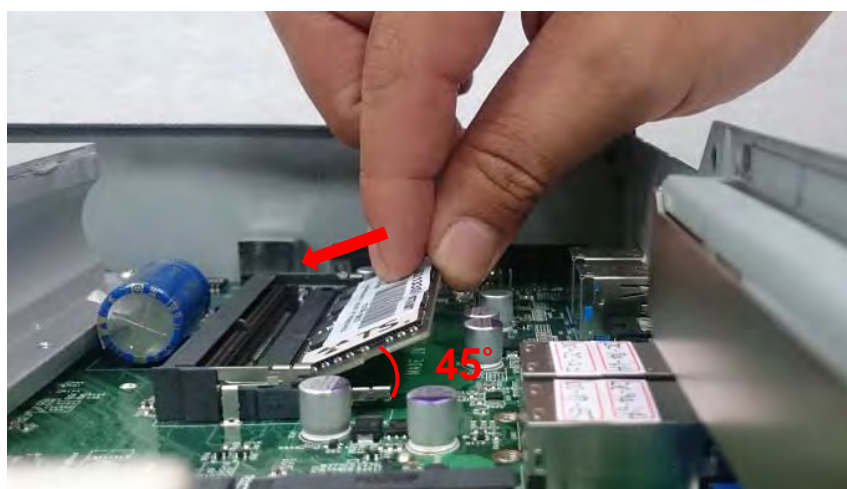

3. Press down the memory module until retaining clips snap back in place.





4. For the upper SO-DIMM socket, please follow the same steps described earlier to install.



### 3.7 Installing a PCI(e) Card

1. Locate the retention module of PCI(e) expansion card.



2. Loosen one screw halfway as indicated to have the clamp arm slidable.



3. Loosen one screw to remove the PCI bracket.



4. Align the notch of golden fingers of PCI(e) card with the expansion slot. Insert the card horizontally, and press the card straight down into the slot until it's seated firmly.



5..Fasten one screw to secure the PCI(e) expansion card.



6. Slide the clamp arm of retention module until it contacts the edge of PCI(e) expansion card.



7. Finally, fasten the screw that were previously loosen halfway to fix the retention module.



### 3.8 Installing Thermal Pad of Thermal Block

Place thermal pad on the top of CPU thermal block in order to provide a seamless contact with the body of chassis to create a efficient heat dissipation.



### 3.9 Installing a Power Ignition Daughter Board (Optional)

1. Locate the power Ignition connector on system motherboard as indicated.



2. Insert the female connector of power ignition board to the male connector on system motherboard.



3. Fasten two screws to secure the power ignition board.



## 3.10 Installing a PoE Daughter Board (Optional)

1. Locate the PoE connector on system motherboard as indicated.



2. Insert the female connector of PoE daughter board to the male connector on system motherboard.



3. Fasten two screws to secure the PoE board.

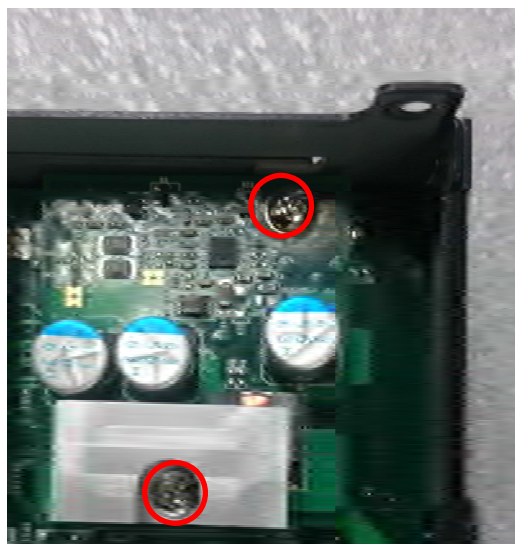

## 3.11 Installing the Top Cover

1. Put on the left edge of top cover onto system, and the other side subsequently.



2. Fasten the six screws at front and rear panel to secure the top cover.



## 3.12 Installing a SATA Hard Drive at Front Panel

1. Turn over the system to bottom side, and remove one screw.

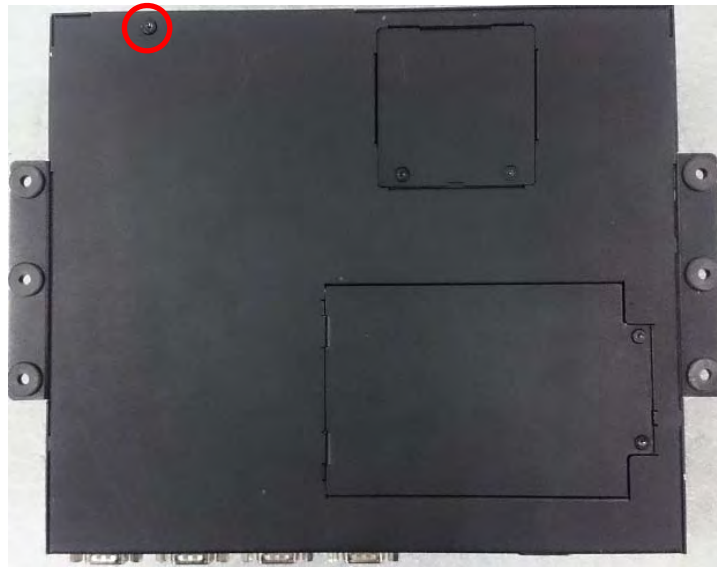

2. Loosen the two screws to remove the HDD bay cover bracket.



3. Pull the rotating arm of HDD bracket outward as indicated.



4. Hold the rotating arm to pull out the HDD bracket.



5. Place the HDD bracket on screw-hole side of HDD. Use four screws provided to assemble HDD on the bracket.

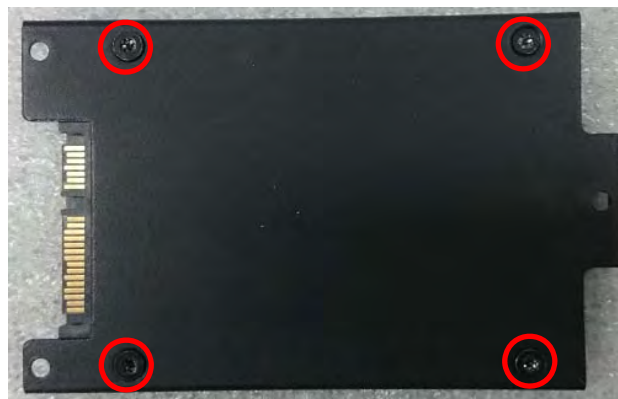

6. Align the HDD bracket with the entrance of HDD bay. And insert the HDD bracket and push it until the edge connector of HDD fully inserted into SATA slot.





7. Put back HDD bay cover at front panel, and fasten it with two screws.



8. Fasten one screw to secure the HDD bracket on the system chassis.

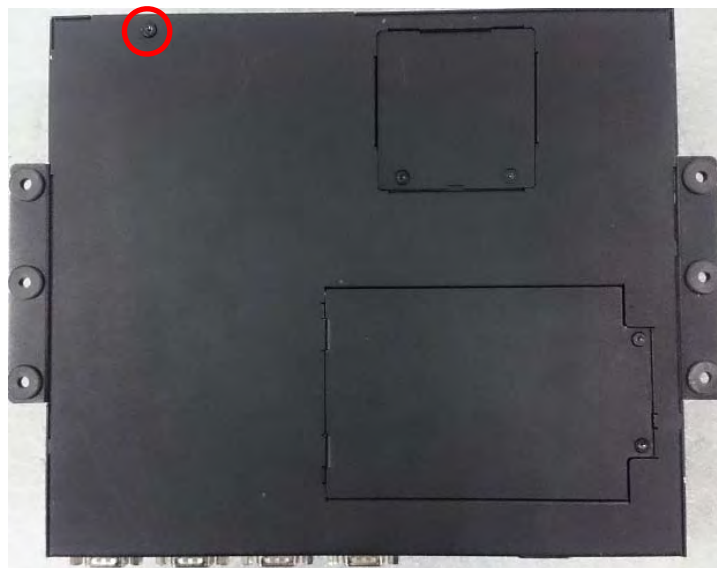

### 3.13 Installing a SATA hard drive on Bottom Side

1. Turn over the system to bottom side. Locate the cover of HDD compartment.

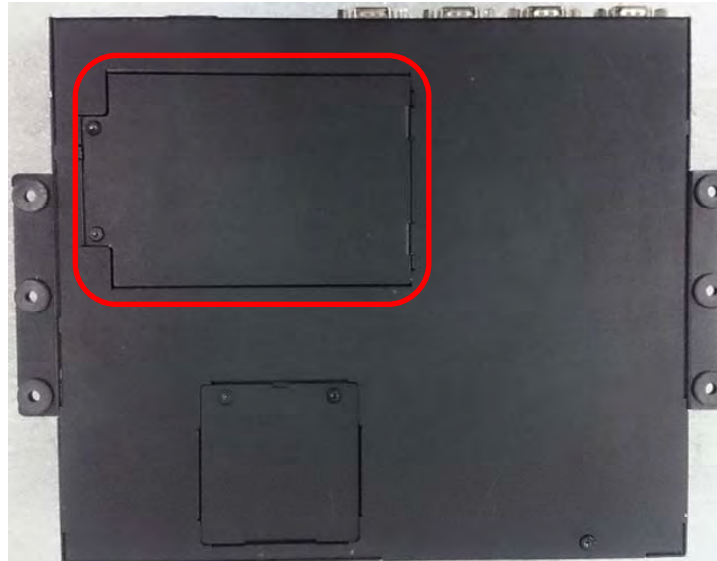

2. Loosen the two screws, then pull the cover to remove it.

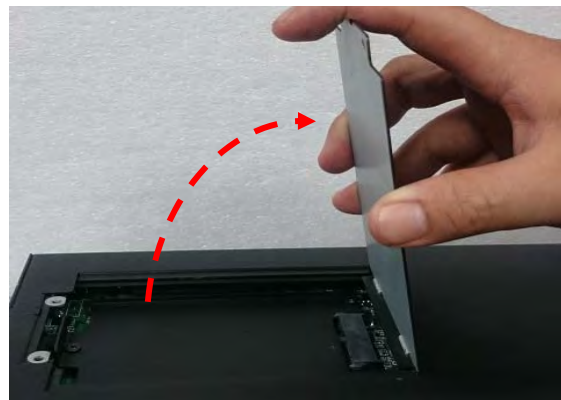

3. Loosen three screws and take the HDD bracket out of HDD compartment.

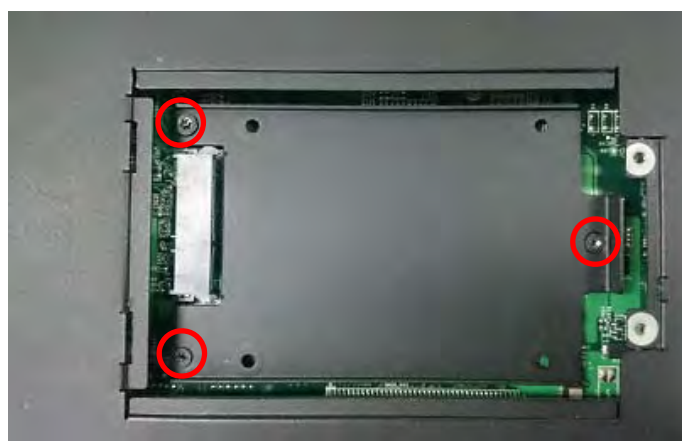

- Place the HDD bracket on screw-hole side of HDD. Use four screws provided to assemble HDD on the bracket.

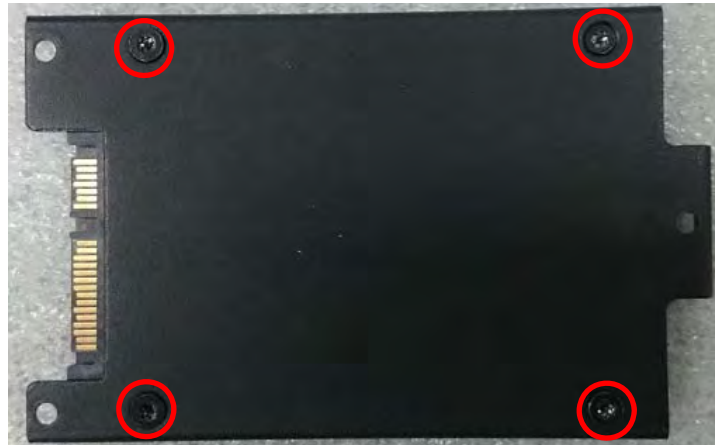

- Seat the HDD bracket into HDD compartment, and line up the connector of HDD with SATA slot, then push it until HDD is fully connected into slot.

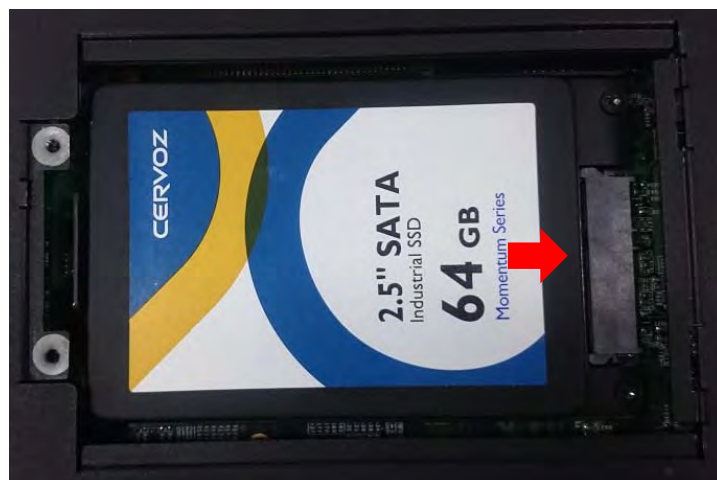

- Secure the HDD bracket with three screws.



7. Put back the cover and fasten the two screws.

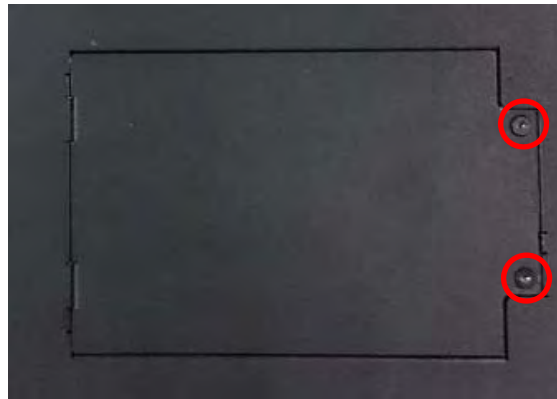

### 3.14 Installing a SIM Card

1. Locate the SIM card slot at front panel.



2. Loosen two screws to remove the cover plate.



3. Insert the SIM card.



## 3.15 Installing a CFast Card

1. Locate the CFast card slot at front panel.



2. Loosen the two screws to remove the cover plate.



3. Insert a CFast card.



4. Fasten two screws to secure the cover plate.



## 3.16 Connecting with PowerTwin Display Module

1. Prepare the mounting kit that accompanied with pc module as shown. (including two mounting brackets and one screw pack)

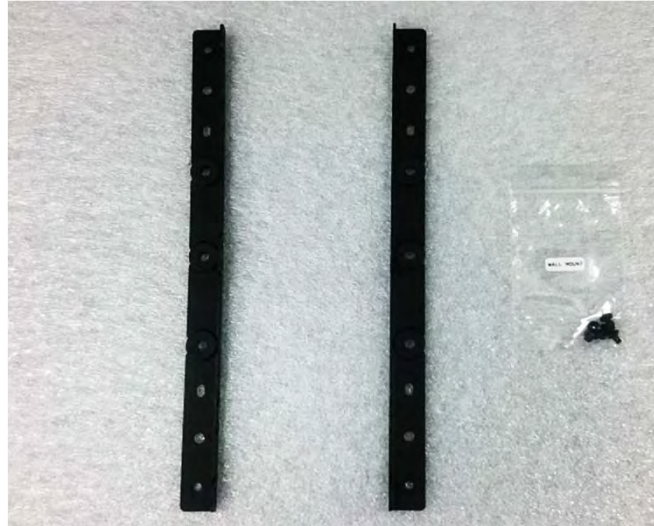

2. Remove six screws at left and right panel of pc module.



3. Assemble two mounting brackets to left and right panel of the module by fastening three screws at each side.



Left Panel



Right Panel

4. Turn over the system to bottom side. Locate the connector cover of display module.

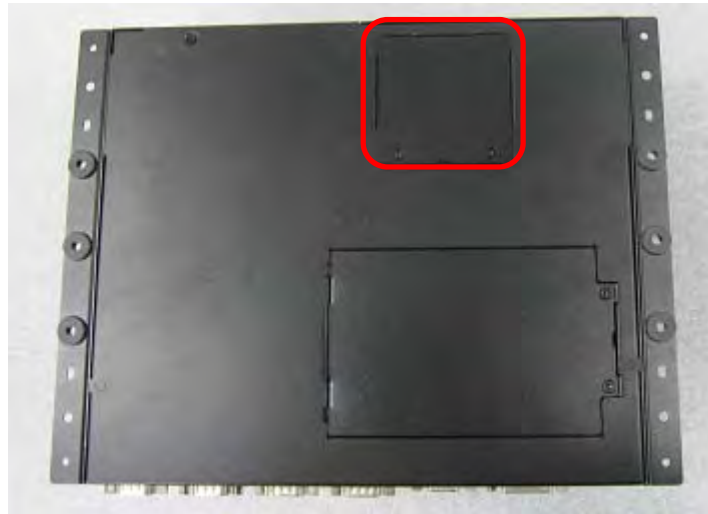

5. Loosen two screws to remove the cover.

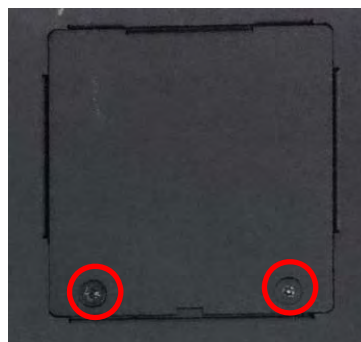

The following photos indicates the male connector (on display module) and female connector (on pc module).



6. Place the pc module on the display module through its display connector hole as indicated.



7. Align the mounting holes of pc module with the screw holes of display module underneath. Then slide the module carefully as indicated to have the module and display connected together.

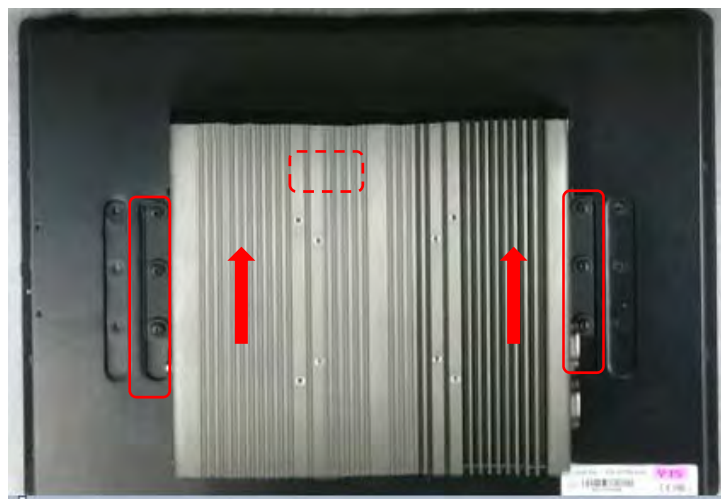

8. Fasten six screws to secure module on the display module.

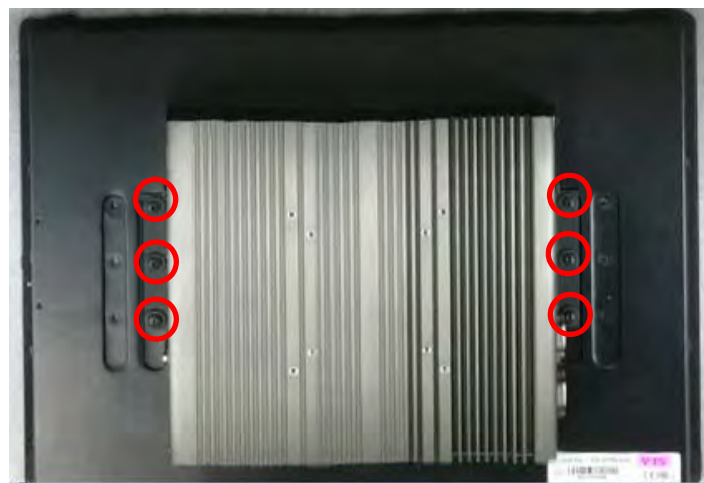



### 3.17 VESA Mount

The following picture indicates VESA mounting hole pattern on PC module, which is compliant with VESA mounting standard.



1. The following picture uses a panel PC (PC module + PowerTwin display) as a demonstration. To attach the panel PC to a VESA stand, please fasten eight screws as indicated to fix it on the stand. (Please refer to section 3.15 in this manual for how to attach pc module to display.)

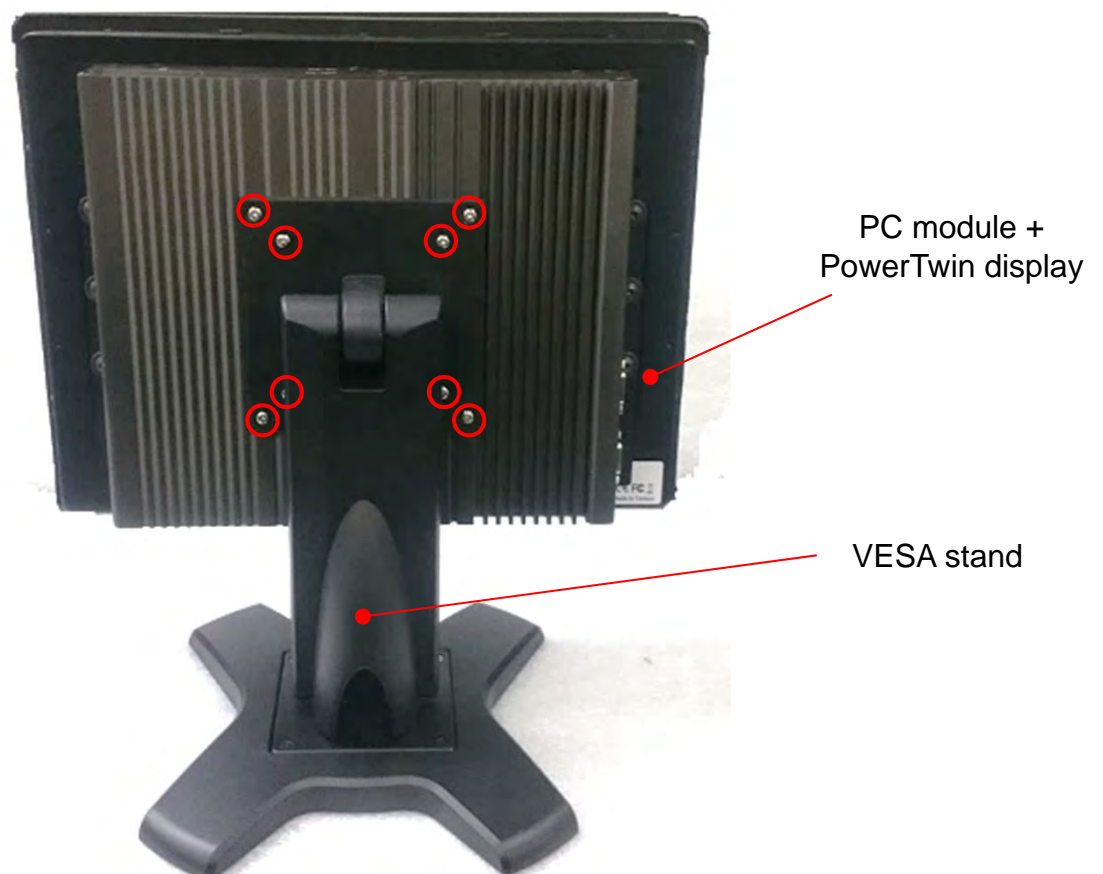

### 3.18 Panel Mount

Accessories provided by Spectra are as follows.

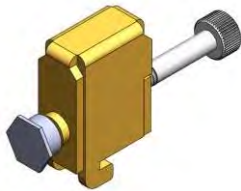

Mounting Kits

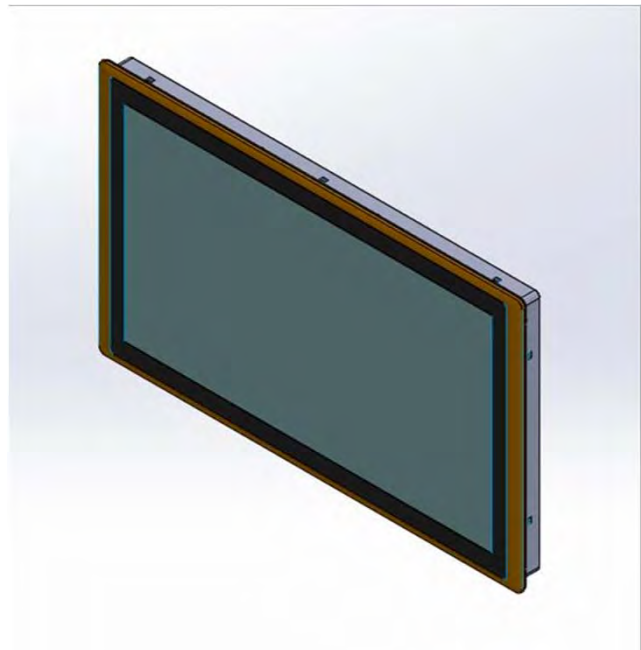

Panel Mount PPC

Before assembly, please prepare panel mount PPC and customer's fixture.

Panel Mount with customer's fixture  
(Front View)

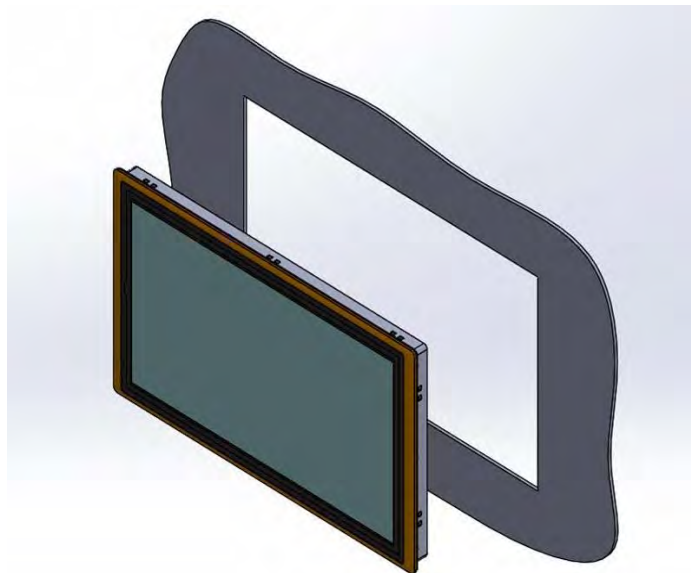

2. All mounting kits displayed are to be inserted into holes.

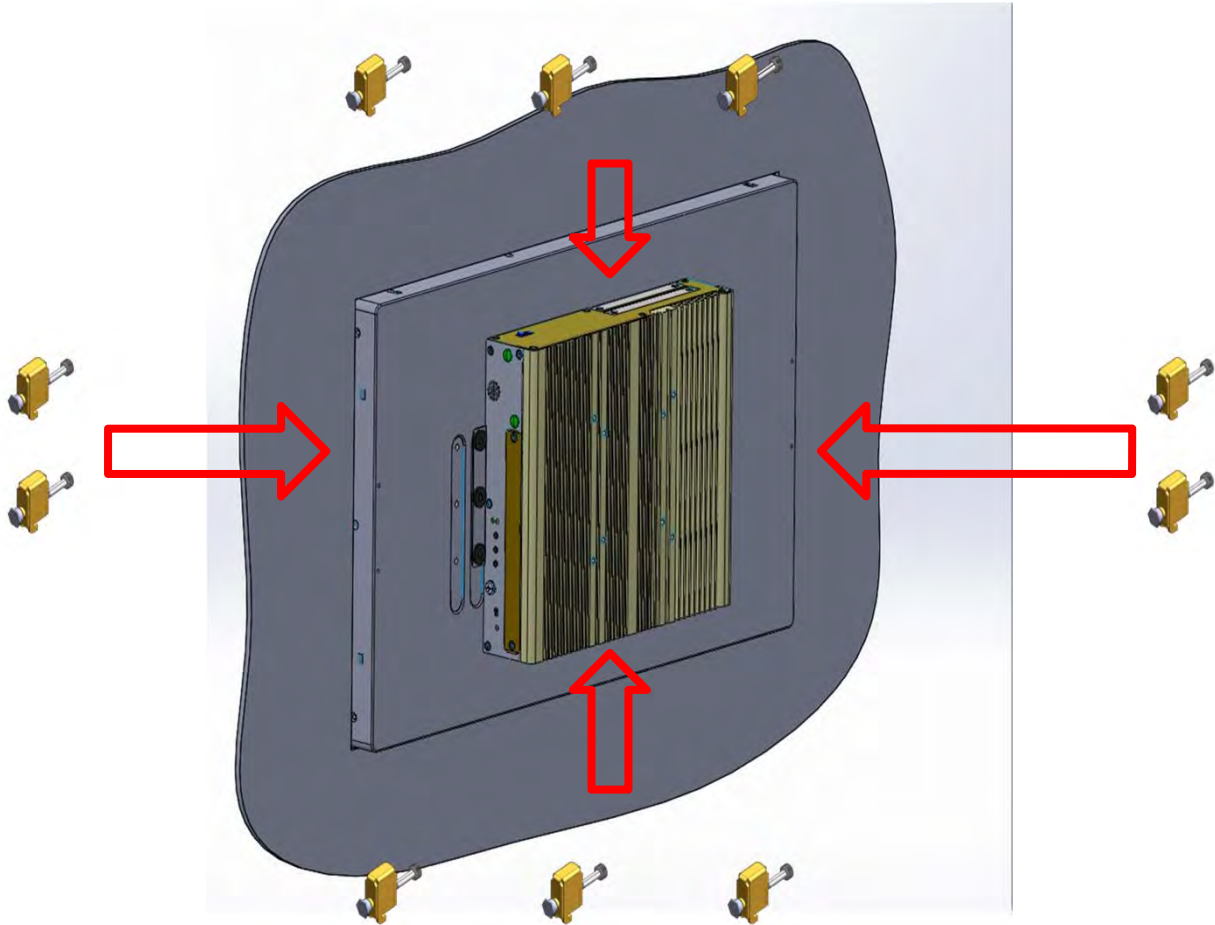

3. Installation preparation and steps.

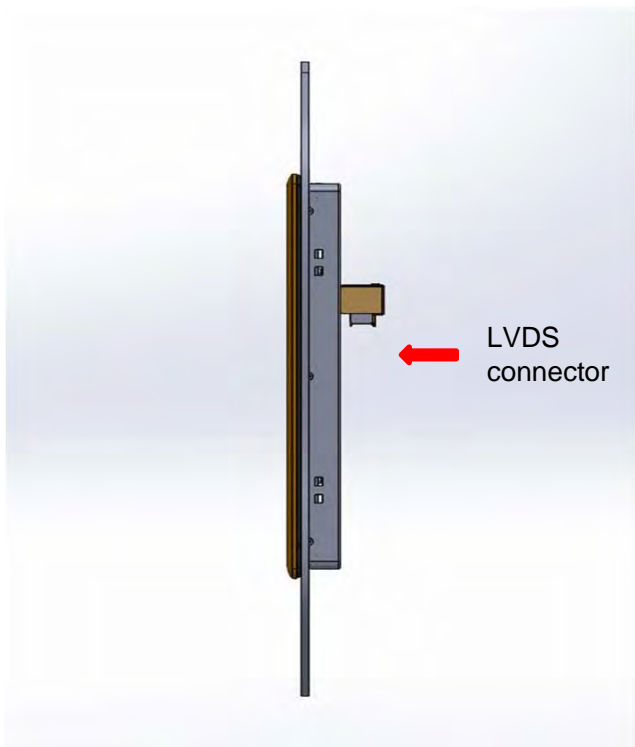

Panel mount side view with LVDS connector of PowerTwin series

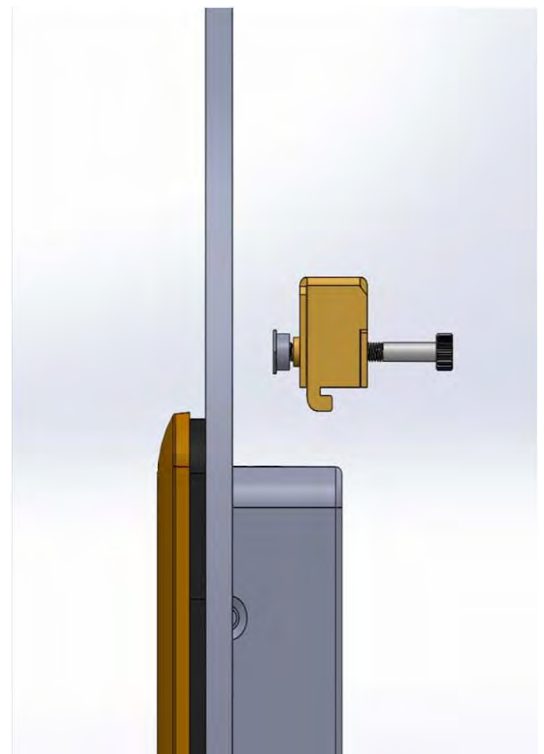

Before Mounting Kits are installed

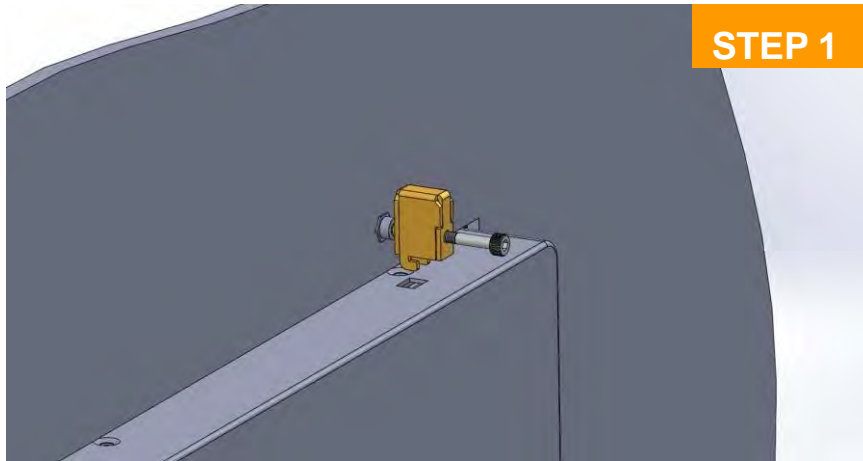

Position panel mount kits

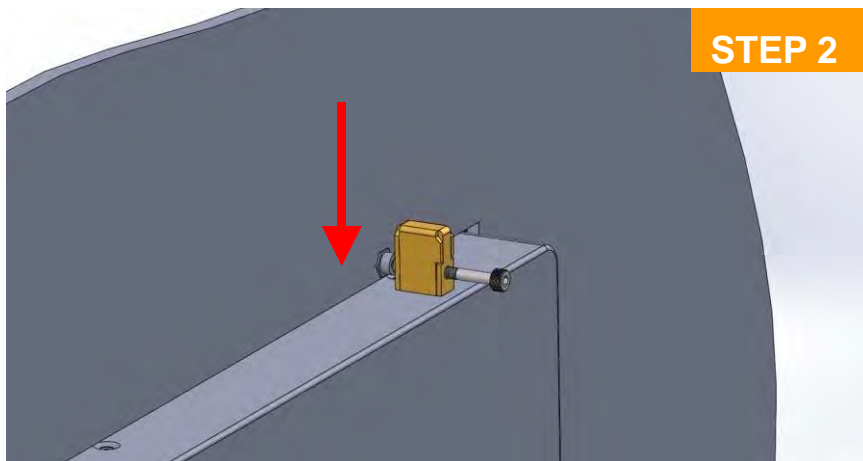

Insert the panel mounting kit into bottom hole

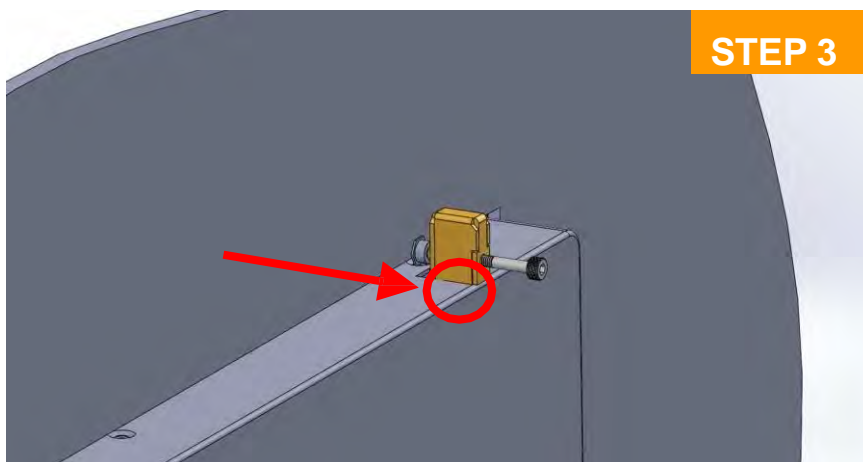

Slide the kit toward back

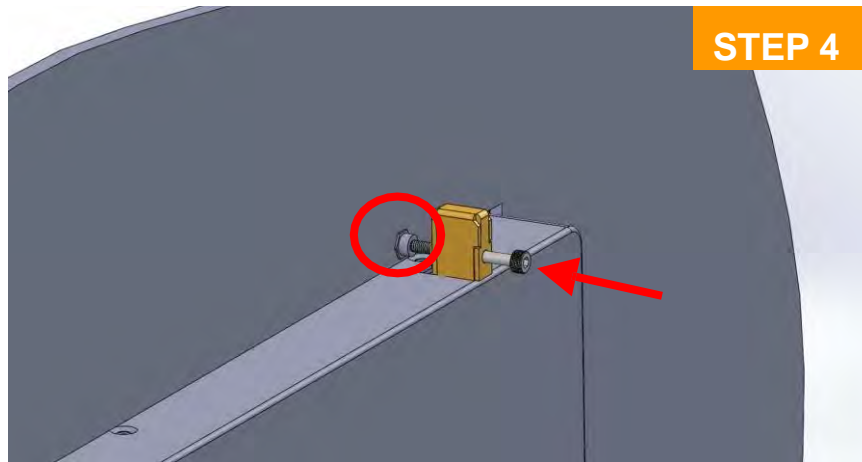

Tighten the screw forward until the front screw just touches the surface

4. Apply all mount kits to the rest of holes. And you have completed the panel mount installation, as shown below.

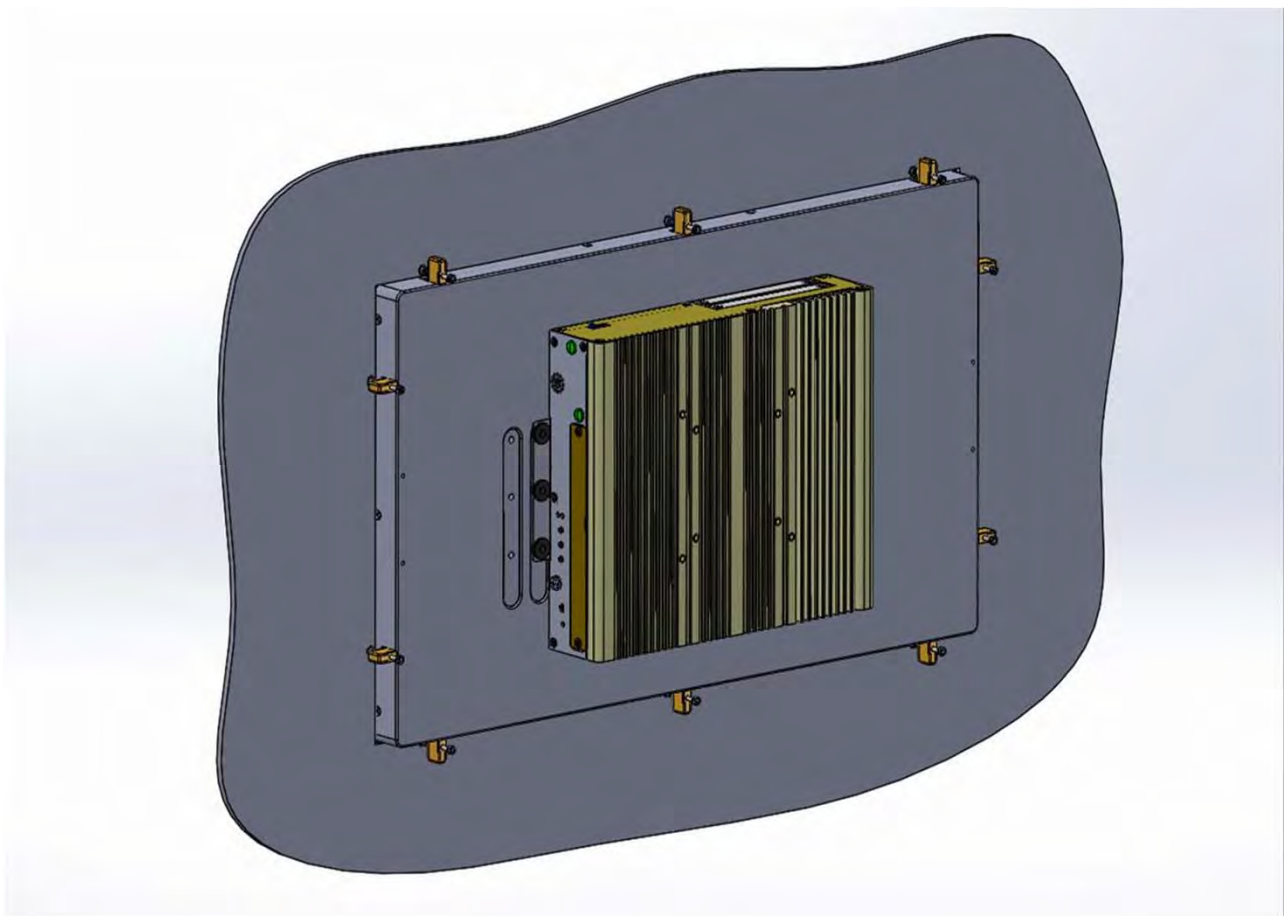

Chapter 4

# BIOS Setup

## 4.1 BIOS Introduction

The BIOS (Basic Input/Output System) is a program located on a Flash Memory on the motherboard. When you start the computer, the BIOS program will gain control. The BIOS first operates an auto-diagnostic test called POST (power on self test) for all the necessary hardware, it detects the entire hardware device and configures the parameters of the hardware synchronization.

### BIOS Setup

Power on the computer and by pressing <Del> immediately allows you to enter Setup. If the message disappears before your respond and you still wish to enter Setup, restart the system to try again by turning it OFF then ON or pressing <Ctrl>, <Alt> and <Delete> keys.

Control Keys	
<←> <→>	Move to select screen
<↑> <↓>	Move to select item
<Esc>	Quit the BIOS Setup
<Enter>	Select item
<Page Up/+>	Increases the numeric value or makes changes
<Page Down/->	Decreases the numeric value or makes changes
<Tab>	Select setup fields
<F1>	General help
<F2>	Previous value
<F3>	Load Optimized defaults
<F10>	Save configuration and Exit

### Main Menu

The main menu lists the setup functions you can make changes to. You can use the arrow keys ( ↑↓ ) to select the item. The on-line description of the highlighted setup function is displayed at the bottom of the screen.

### Sub-Menu

If you find a right pointer symbol appears to the left of certain fields that means a sub-menu can be launched from this field. A sub-menu contains additional options for a field parameter. You can use arrow keys ( ↑↓ ) to highlight the field and press <Enter> to call up the sub-menu. Then you can use the control keys to enter values and move from field to field within a sub-menu. If you want to return to the main menu, just press the <Esc >.

## 4.2 Main Setup

Press <Del> to enter BIOS CMOS Setup Utility, the Main Menu (as shown below) will appear on the screen. Use arrow keys to move among the items and press <Enter> to accept or enter a sub-menu.

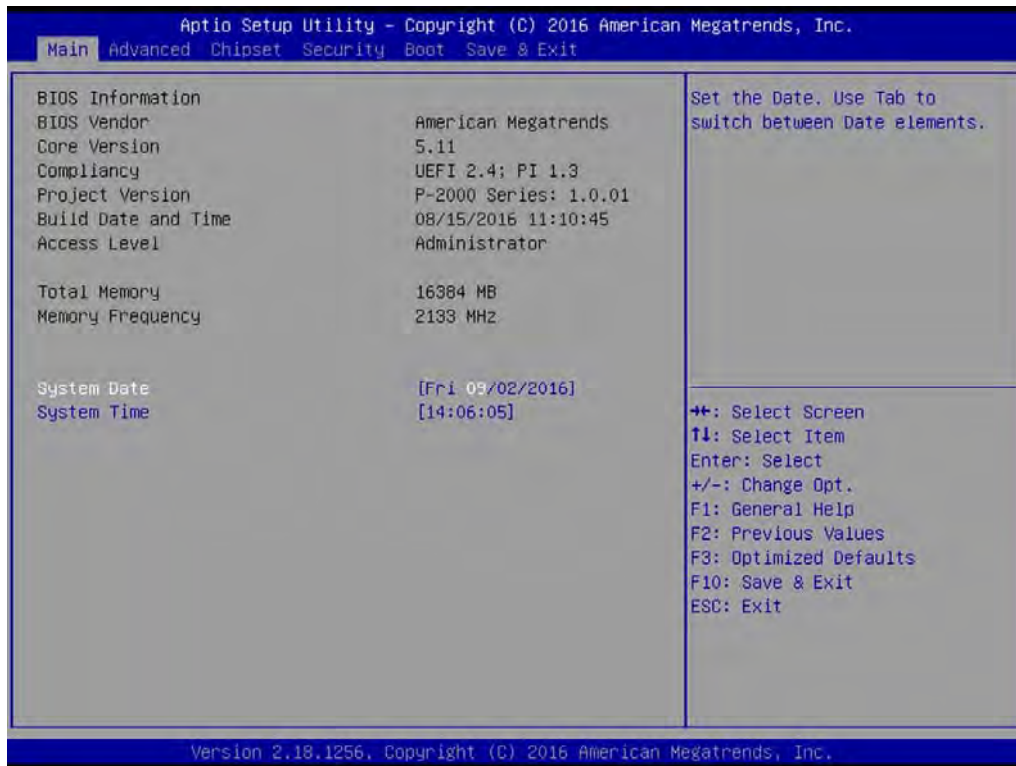

### 4.2.1 System Date

Set the date. Please use <Tab> to switch between date elements.

### 4.2.2 System Time

Set the time. Please use <Tab> to switch between time elements.



## 4.3 Advanced Setup

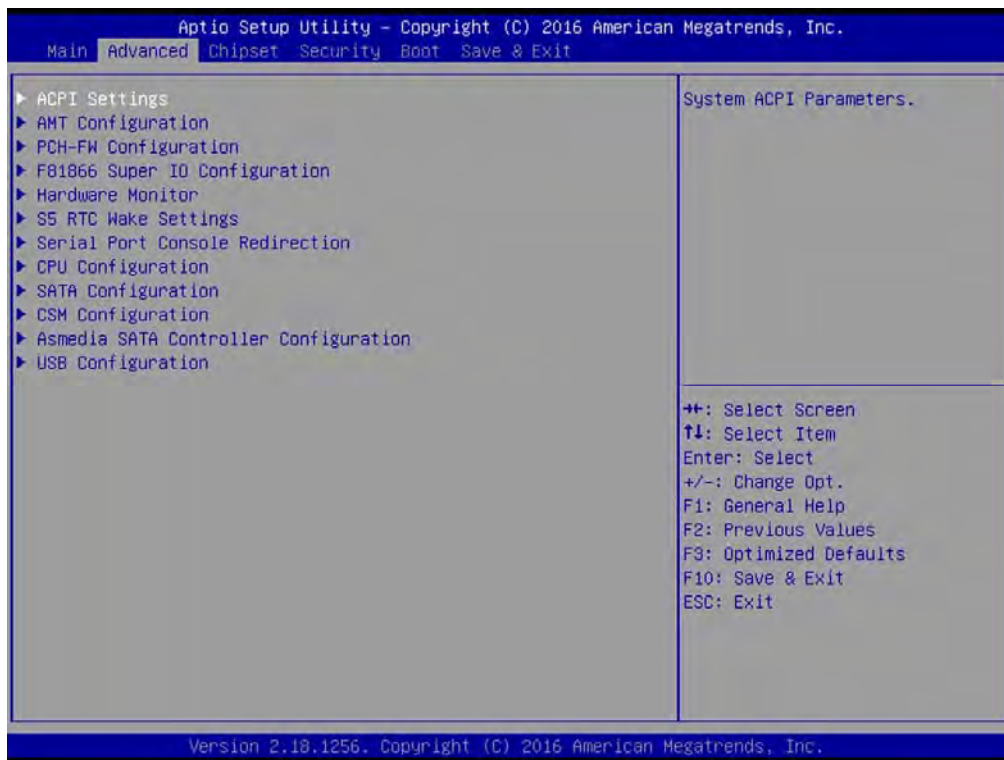

### 4.3.1 ACPI Settings

This item allows users to configure ACPI settings.

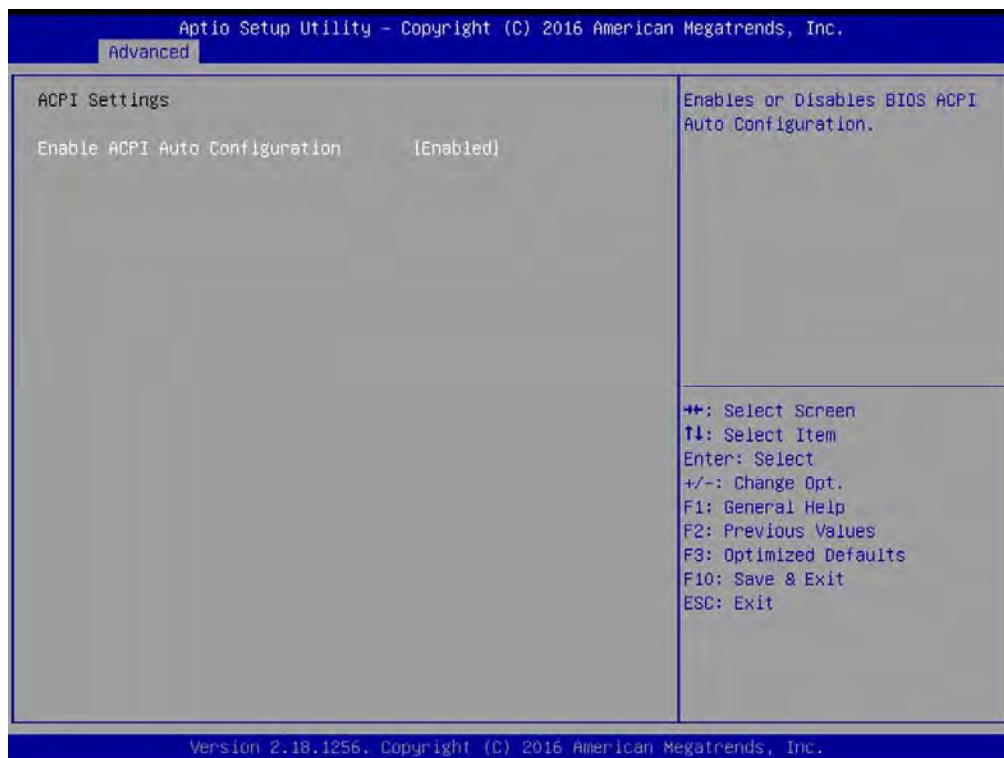

#### ■ Enable ACPI Auto Configuration [Enabled]

Enables or disables BIOS ACPI Auto Configuration.

## 4.3.2 AMT Configuration

This screen allows users to configure related settings of Intel® Active Management Technology.

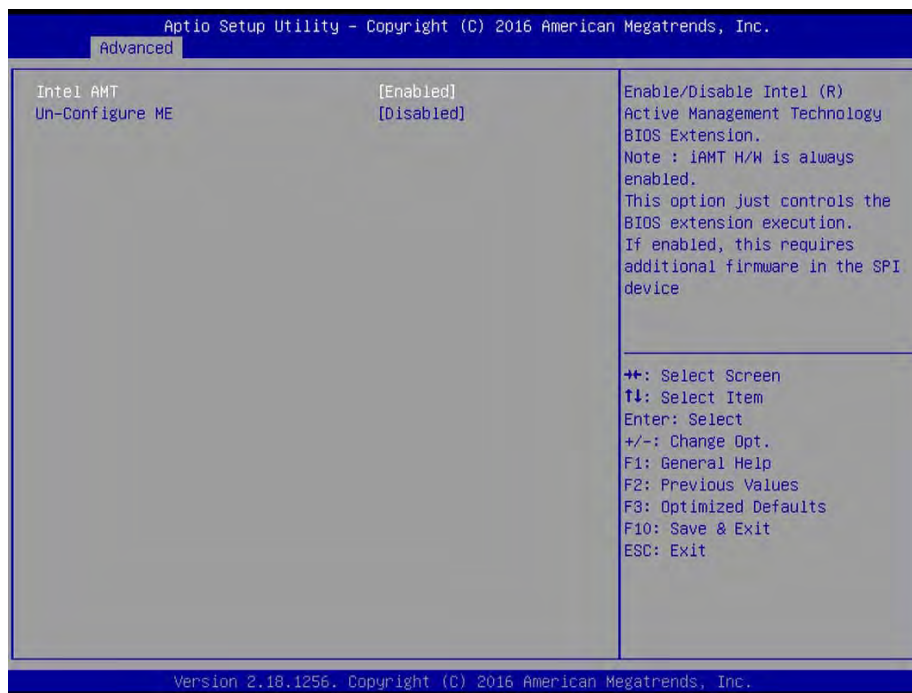

### ■ Intel AMT [Enabled]

Allows you to enable or disable Intel® Active Management Technology BIOS execution.

### ■ Un-Configure ME [Disabled]

Sets this items to [Disabled] to unconfigure AMT/ME without using a password or set it to [Enabled] to use a password.

### 4.3.3 PCH-FW Configuration

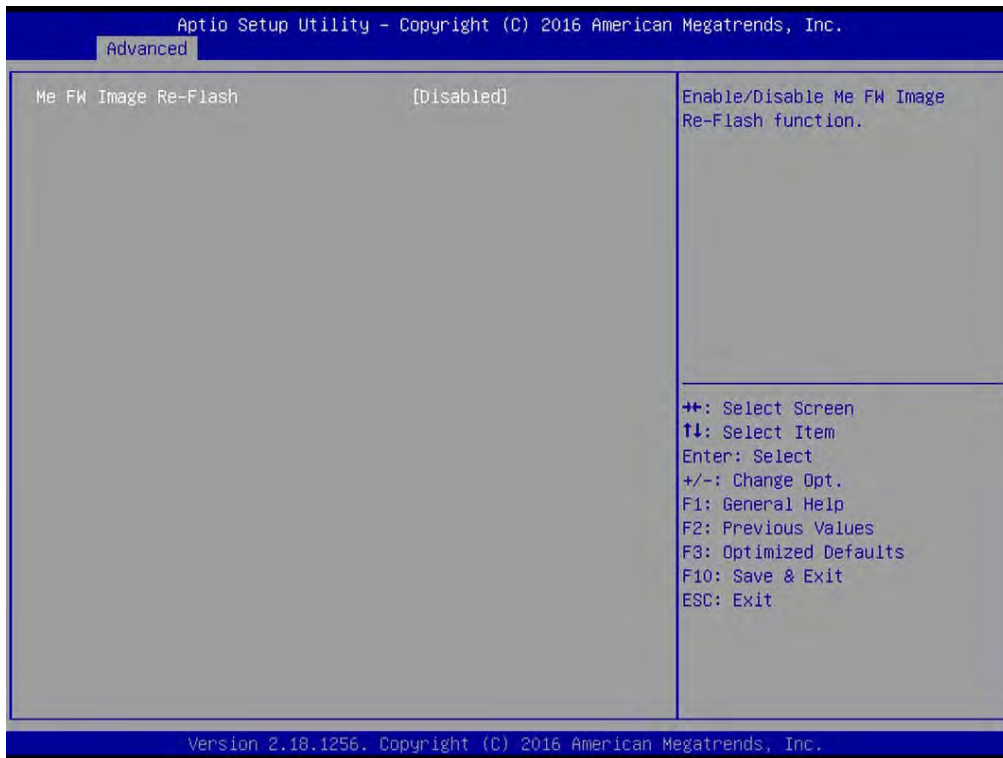

#### ■ Firmware Update Configuration

##### ME FW Image Re-Flash [Disabled]

Allows you to enable or disable ME firmware image re-flash function.

### 4.3.4 F81866 Super IO Configuration

The screen allows users to select options for the Super IO configuration, and change the value of the selected option.

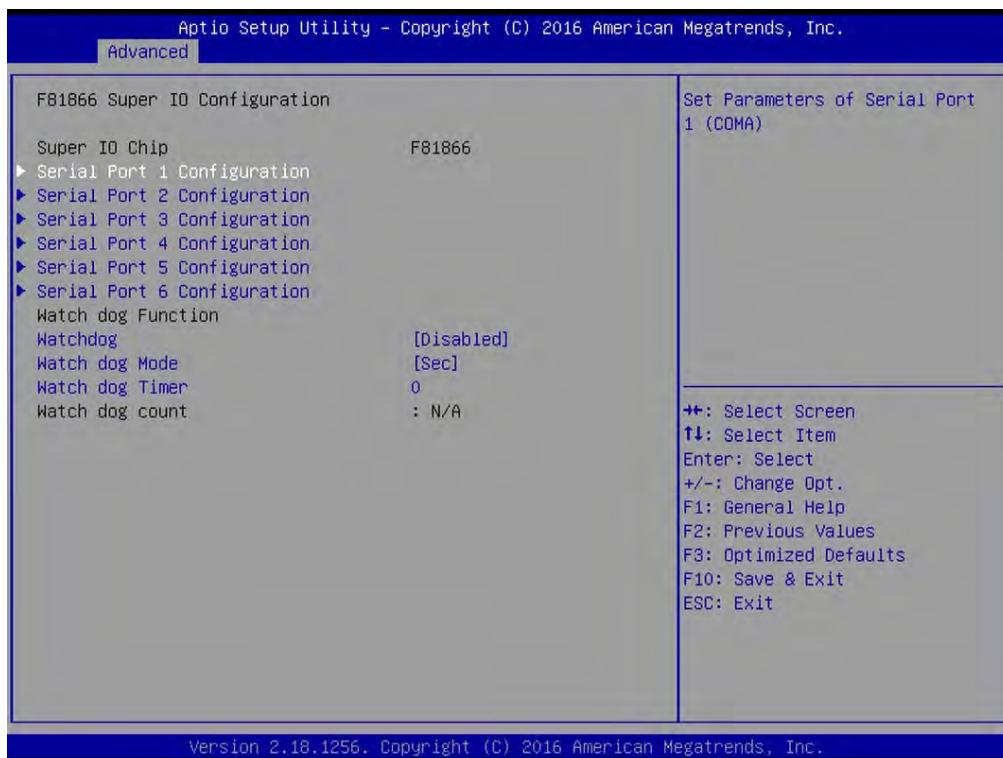

#### Serial Port 1~6 Configuration



#### Serial Port [Enabled]

This item allows users to enable or disable serial port.

#### Change Settings [Auto]

This item allows users to change the address & IRQ settings of the specified serial port.

#### Onboard Serial Port 1 Mode [RS232]

This item allows users to select Serial Port Mode.

Configuration options: [RS232] [RS422] [RS485]

■ **Watch Dog [Disabled]**

Enables or disables watch dog function.

■ **Watch Dog Mode [Sec]**

Changes the Watch dog mode. Select [Sec] or [Min] mode.

■ **Watch Dog Timer [0]**

User can set a value in the range of 0 to 255.

### 4.3.5 Hardware Monitor

These items display the current status of all monitored hardware devices/ components such as voltages and temperatures.

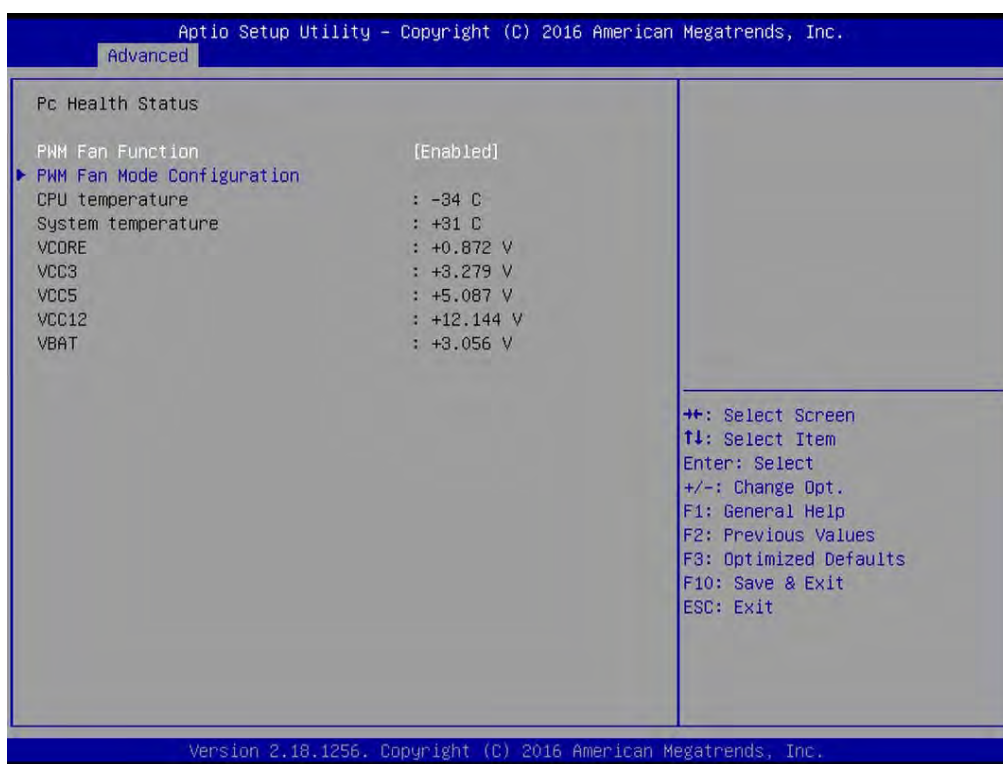

■ **PWM Fan Mode Configuration**

**PWM Fan1 Duty [60%]**

This item allows users to change duty cycle value of PWM Fan1.

**PWM Fan2 Duty [60%]**

This item allows users to change duty cycle value of PWM Fan2.

### 4.3.6 S5 RTC Wake Settings



#### ■ Wake System from S5 [Disabled]

This item allows users to change the way to wake system from S5 state.

[Fixed Time]: Set the specified time (HH:MM:SS) to wake system.

[Dynamic Time]: Set the increase time from current time to wake system.

### 4.3.7 Serial Port Console Redirection

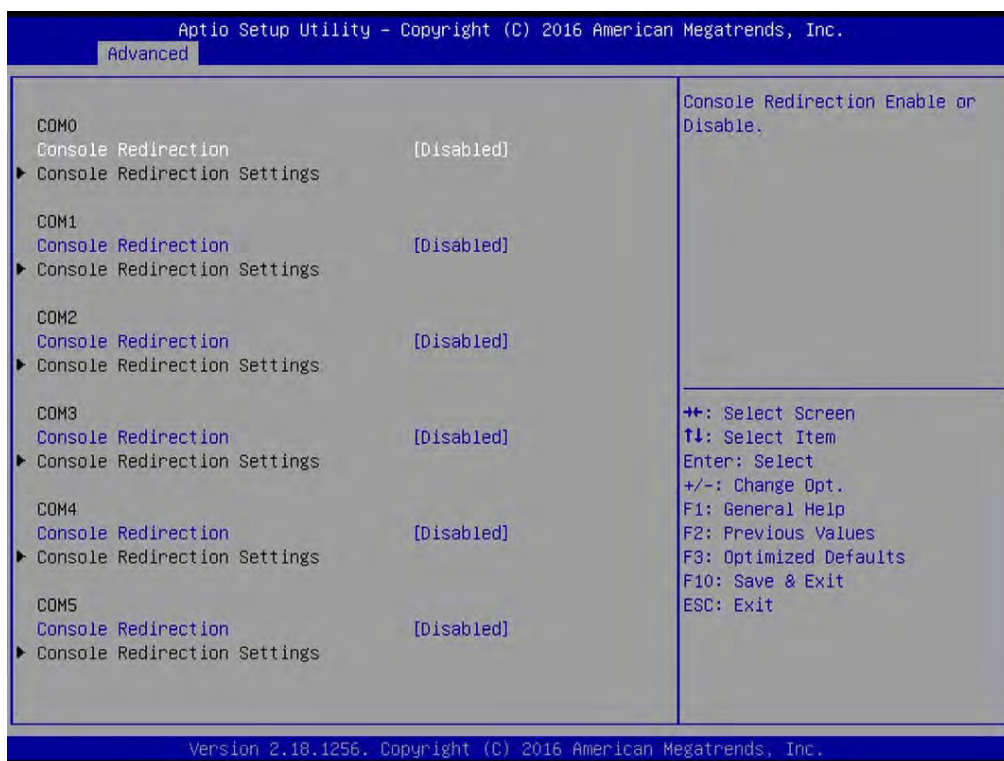

#### ■ Console Redirection [Disabled]

These items allow users to enable or disable COM0, COM1, COM2, COM3, Com4, COM5 console redirection function.

### 4.3.8 CPU Configuration

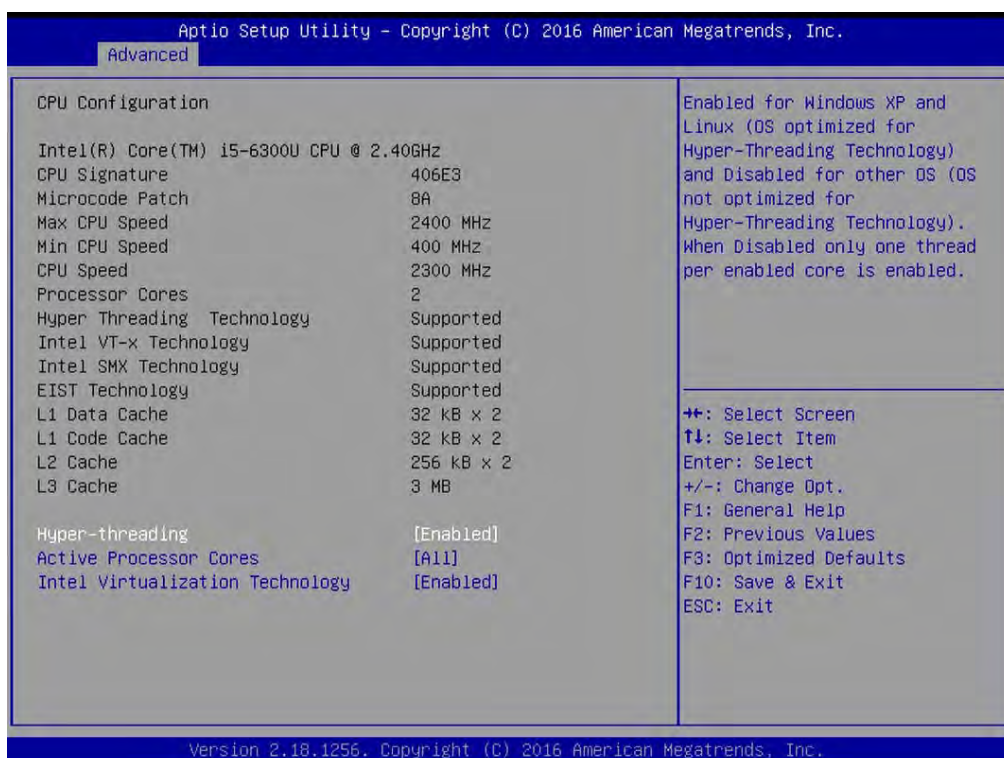

### ■ Hyper-Threading [Enabled]

Allows you to enable or disable Intel® Hyper-Threading function of processor.

### ■ Active Process Cores [All]

Allows you to choose the number of active processor cores.

Configuration options: [All] [1].

### ■ Intel® Virtualization Technology [Enabled]

Enables or disables Intel® Virtualization Technology. Virtualization enhanced by Intel® Virtualization Technology will allow a platform to run multiple operating systems and applications in independent partitions. With virtualization, one computer system can function as multiple virtual systems..

## 4.3.9 SATA Configuration

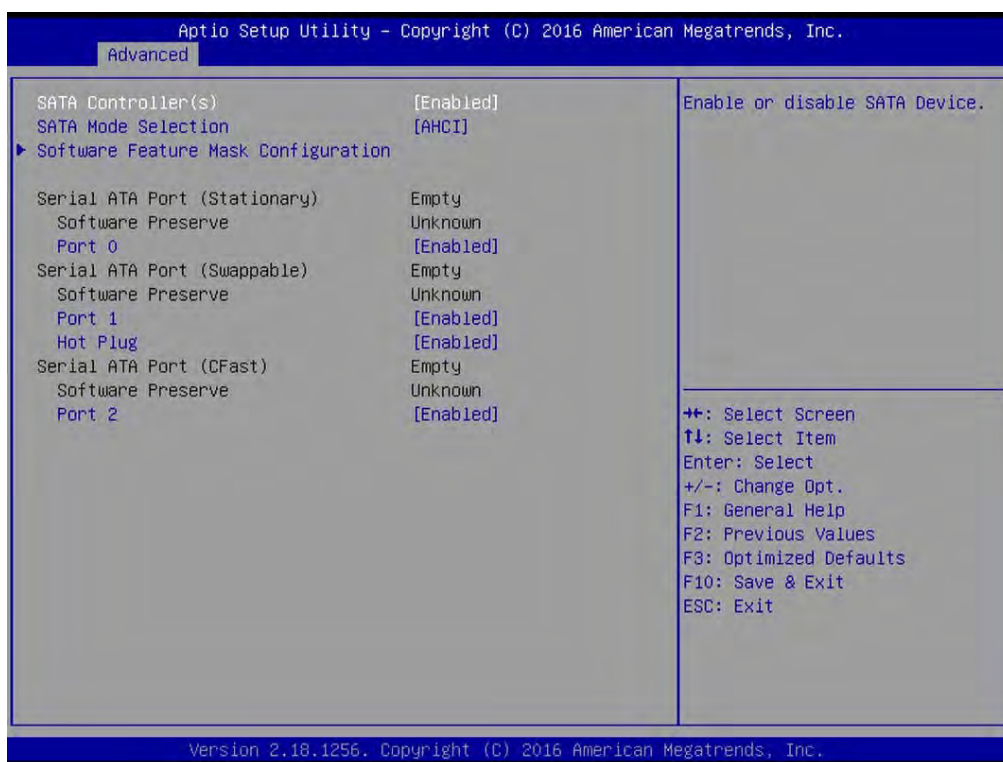

### ■ Serial Controller(s) [Enabled]

Allows you to enable or disable Serial ATA controller.

### ■ SATA Mode [AHCI]

This item allows users to choose [AHCI] or [RAID] mode.

### ■ Software Feature Mask Configuration

RAID option ROM (OROM) / Intel® Rapid Storage Technology(RST) driver will refer to the software feature configuration to enable or disable the storage features.

#### RAID0 [Enabled]

Enables or disables RAID0 function.

#### RAID1 [Enabled]

Enables or disables RAID1 function.



- Intel Rapid Recovery Technology [Enabled]**  
Enables or disables Intel® Rapid Recovery Technology function.
- OROM UI and BANNER [Enabled]**  
Enables or disables option ROM UI banner.
- OROM UI Normal Delay [2 Seconds]**  
Changes the delay time for option ROM.
- HDD Unlock [Enabled]**  
Enables or disables HDD unlock.
- LED Locate [Enabled]**  
Enables or disables LED Locate.
- Smart Response Technology [[Enabled]**  
Enables or disables Smart Response Technology.
- RST Force Form [Disabled]**  
Enables or disables Intel® Storage Technology(RST) Force Form.

#### ■ **Serial ATA Port (Stationary)**

- Port 0 [Enabled]**  
Enables or disables SATA Port 0.

#### ■ **Serial ATA Port (Swappable)**

- Port 1 [Enabled]**  
Enables or disables SATA Port 1.
- Hot Plug [Enabled]**  
Enables or disables Hot Plug support for port1.

#### ■ **Serial ATA Port (CFast)**

- Port 2 [Enabled]**  
Enables or disables SATA Port 2.

## 4.3.10 CSM Configuration

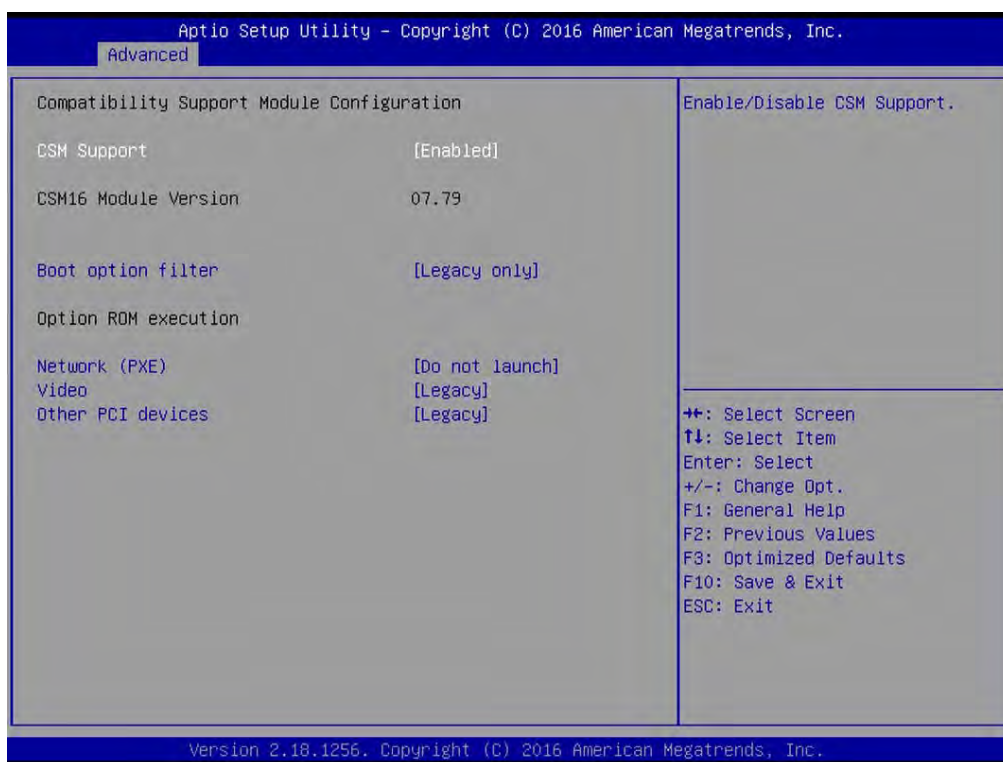

### ■ CSM Support [Enabled]

This item allows users to enable or disable UEFI Compatibility Support Module (CSM) to support a legacy PC boot process.

### ■ Boot option filter [Legacy only]

This item allows users to select which type of operating system to boot.

[UEFI and Legacy]: Allows booting from operating systems that support legacy option ROM or UEFI option ROM.

[Legacy only]: Allows booting from operating systems that only support legacy option ROM.

[UEFI only]: Allows booting from operating systems that only support UEFI option ROM.

**This item is configurable only when CSM Support is set to Enabled.**

### ■ Network PXE [Do not launch]

This item allows users to enable or disable Network Preboot eXecution Environment (PXE) function.

[Do not launch]: Disables option ROM.

[UEFI]: Enables UEFI option ROM only.

[Legacy]: Enables legacy option ROM only.

### ■ Video [Legacy]

This item allows users to select whether to enable the UEFI or legacy option ROM for the video devices.

[Do not launch]: Disables option ROM.

[UEFI]: Enables UEFI option ROM only.

[Legacy]: Enables legacy option ROM only.

### ■ Other PCI devices [Legacy]

This item allows users to select whether to enable the UEFI or legacy option ROM for the other PCI devices.

[Do not launch]: Disables option ROM.

[UEFI]: Enables UEFI option ROM only.

[Legacy]: Enables legacy option ROM only.

### 4.3.11 Asmedia SATA Controller Configuration

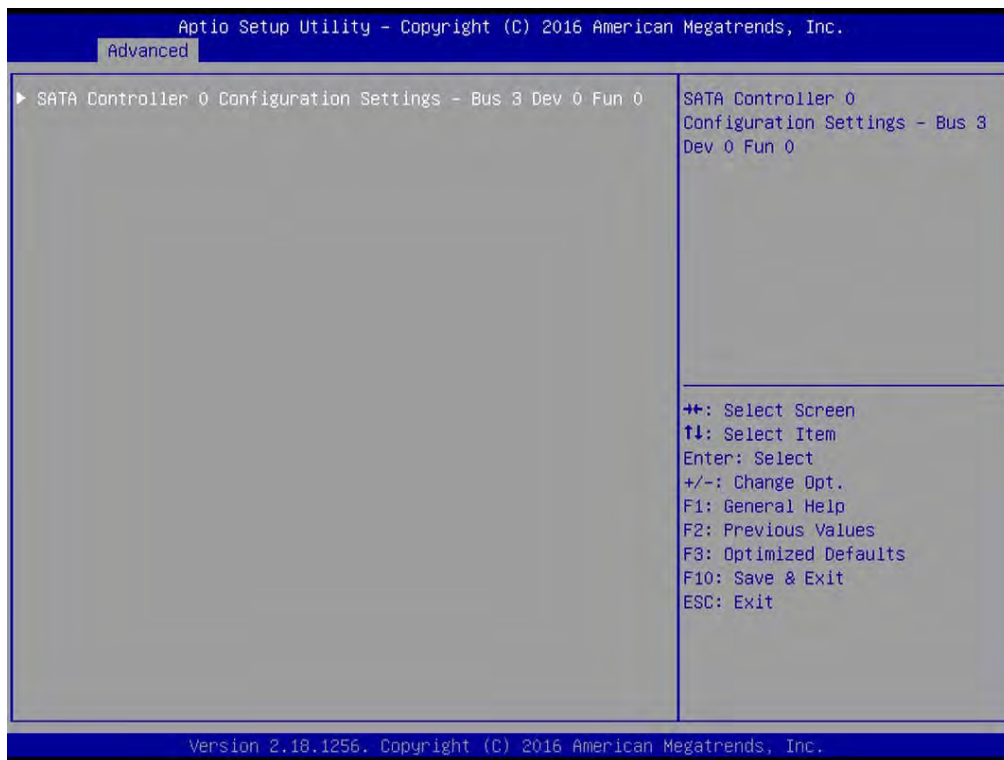

#### ■ SATA Controller 0 Configuration Settings

Displays configuration information on SATA Controller 0.

## 4.3.12 USB Configuration

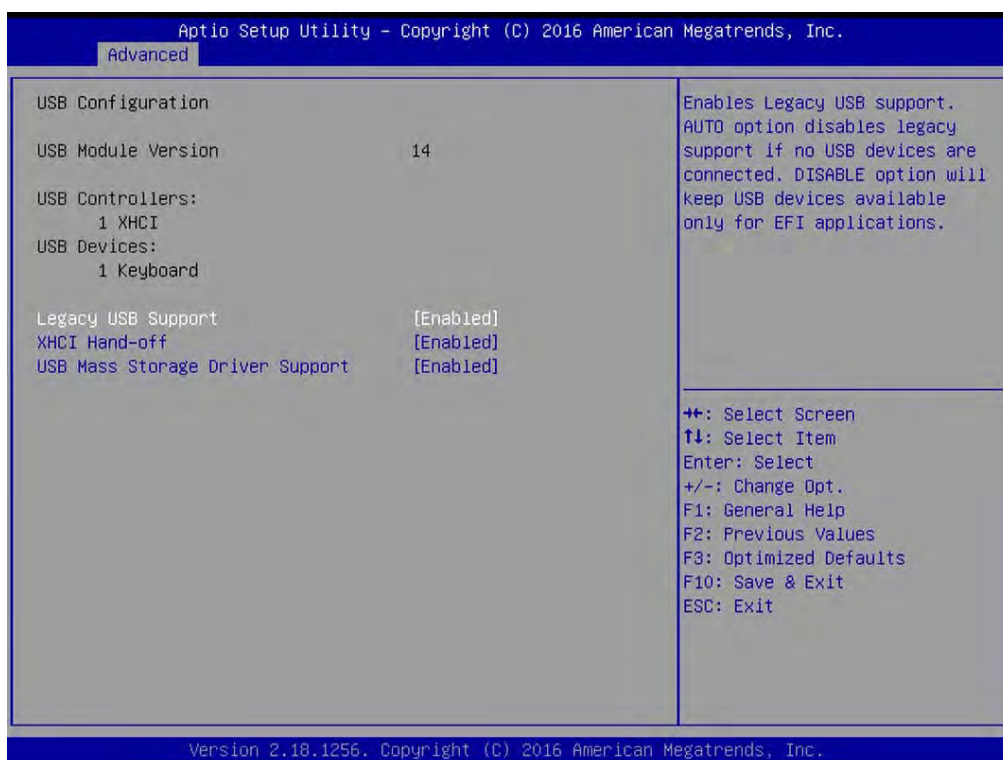

### ■ Legacy USB Support [Enabled]

This item allows users to enable or disable legacy USB support. When set to [Auto], legacy USB support will be disabled automatically if no USB devices are connected.

### ■ XHCI Hand-off [Enabled]

This item allows users to enable or disable XHCI (USB3.0) hand-off function.

### ■ USB Mass Storage Driver Support [Enabled]

Enables or disables support for USB mass storage devices.

## 4.4 Chipset Setup

This section allows you to configure chipset related settings according to user's preference.

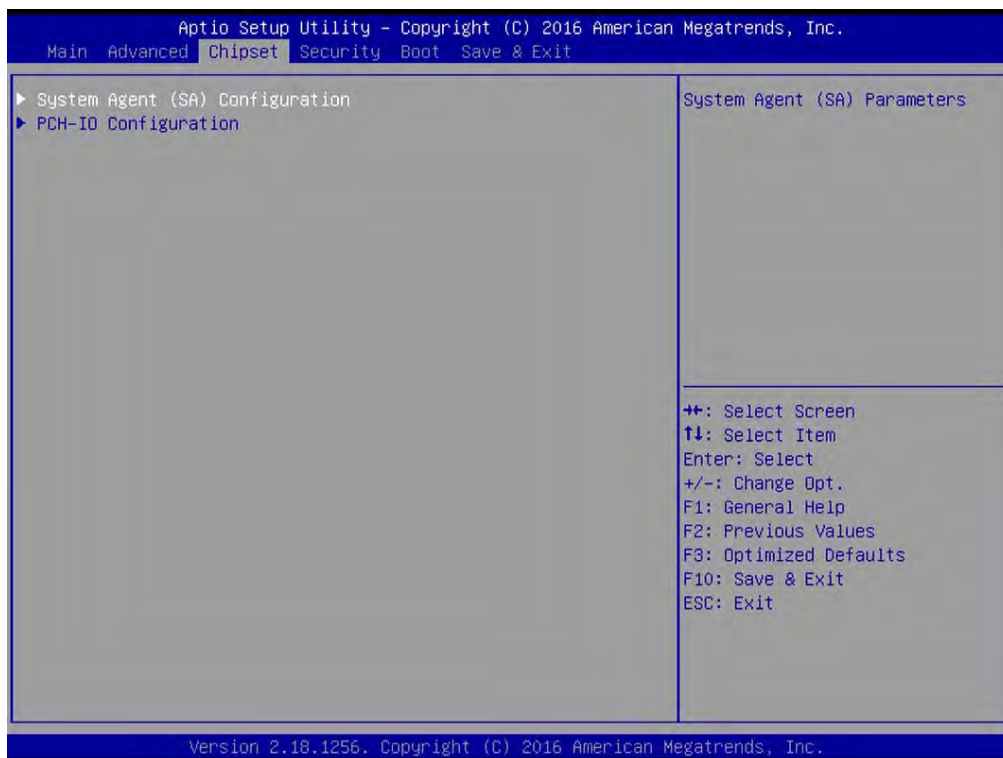

### 4.4.1 System Agent (SA) Configuration



#### ■ VT-d [Enabled]

This item allows users to enable or disable Intel® Virtualization Technology for Directed I/O (VT-d) function.

### ■ Above 4GB MMIO BIOS assignment [Enabled]

This item allows user to enable or disable the Above 4GB Memory Mapped IO BIOS assignment.

### ■ Graphics Configuration

#### □ Primary Display [Auto]

This item allows users to select which graphics device is used as primary display.

[Auto]: auto-detection by BIOS.

[IGFX]: Integrated graphics as primary display.

[PCIe]: Graphics device on PCIe interface as primary display.

#### □ Internal Graphics [Auto]

This item allows users to enable or disable Internal Graphics. When set to [Auto], it will detect by BIOS.

### ■ Memory Configuration

This item displays detailed memory information in the system.

## 4.4.2 PCH-IO Configuration

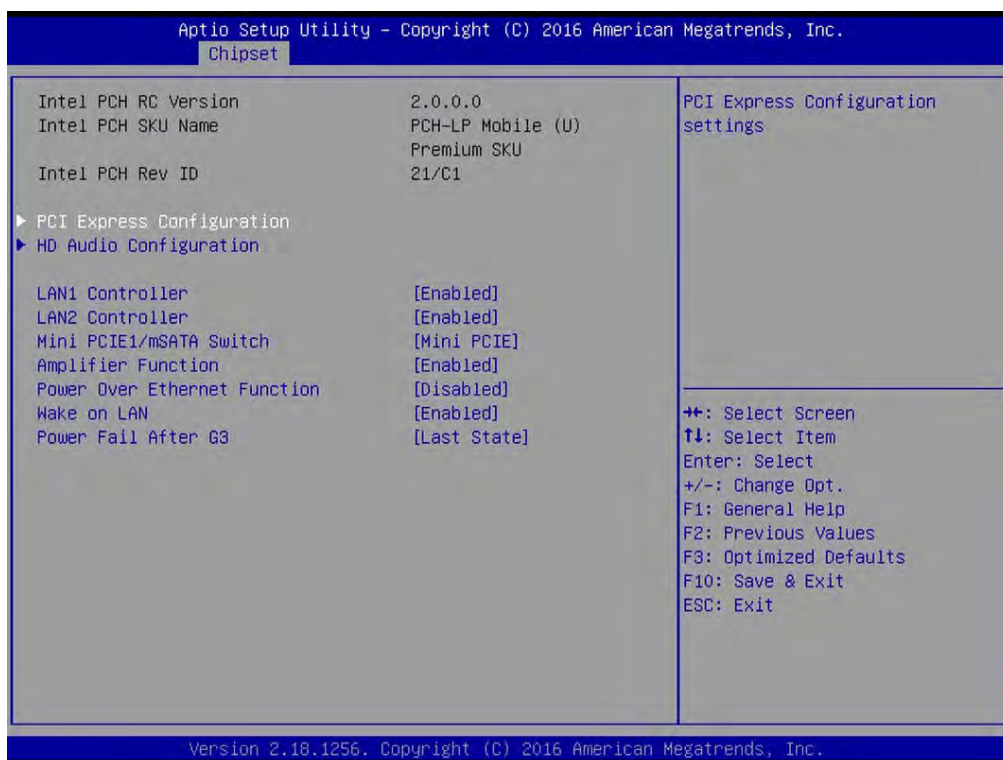

### ■ PCI Express Configuration

#### PCI Express x4 Slot

#### □ PCI Express Port 0 [Enabled]

Allows you to enable or disable PCI Express Port 0.

#### □ PCIe Speed [Auto]

Allows you to select PCI Express interface speed.

Configuration options: [Auto] [Gen1] [Gen2] [Gen3].

### **PCI Express Root Port (Mini PCIe)**

#### **PCI Express Port 5 [Enabled]**

Allows you to enable or disable PCI Express Port 5.

#### **PCIe Speed [Auto]**

Allows you to select PCI Express interface speed.

Configuration options: [Auto] [Gen1] [Gen2] [Gen3].

### **PCI Express Root Port (Mini PCIe)**

#### **PCI Express Port 6 [Enabled]**

Allows you to enable or disable PCI Express Port 6.

#### **PCIe Speed [Auto]**

Allows you to select PCI Express interface speed.

Configuration options: [Auto] [Gen1] [Gen2] [Gen3].

### **■ HD Audio Configuration**

#### **HD Audio [Auto]**

Allows you to select HD Audio options.

[Auto]: HD Audio device will be enabled if present, disabled otherwise.

[Enabled]: HD Audio device is unconditionally enabled.

[Disabled]: HD Audio device is unconditionally disabled.

### **■ LAN1 Controller [Enabled]**

Allows you to enable or disable LAN1 controller.

### **■ LAN2 Controller [Enabled]**

Allows you to enable or disable LAN2 controller.

### **■ Mini PCIe / mSATA switch [Mini PCIe]**

Allows you to choose Mini PCIe or mSATA on the shared slot.

### **■ Amplifier Function [Enabled]**

Allows you to enable or disable Amplifier function.

### **■ Power Over Ethernet Function [Disabled]**

Allows you to enable or disable Power Over Ethernet (POE) function.

### **■ Wake On LAN [Enabled]**

Allows you to enable or disable Wake On LAN (WOL) function.

### **■ Power Fail After G3 [Last State]**

Allows you to specify which power state system will enter when power is resumed after a power failure.

[Last State]: Enter last power state before a power failure.

[S0 State]: Enter power-on state.

[S5 State]: Enter power-off state.



## 4.5 Security Setup

This section allows users to configure BIOS security settings.

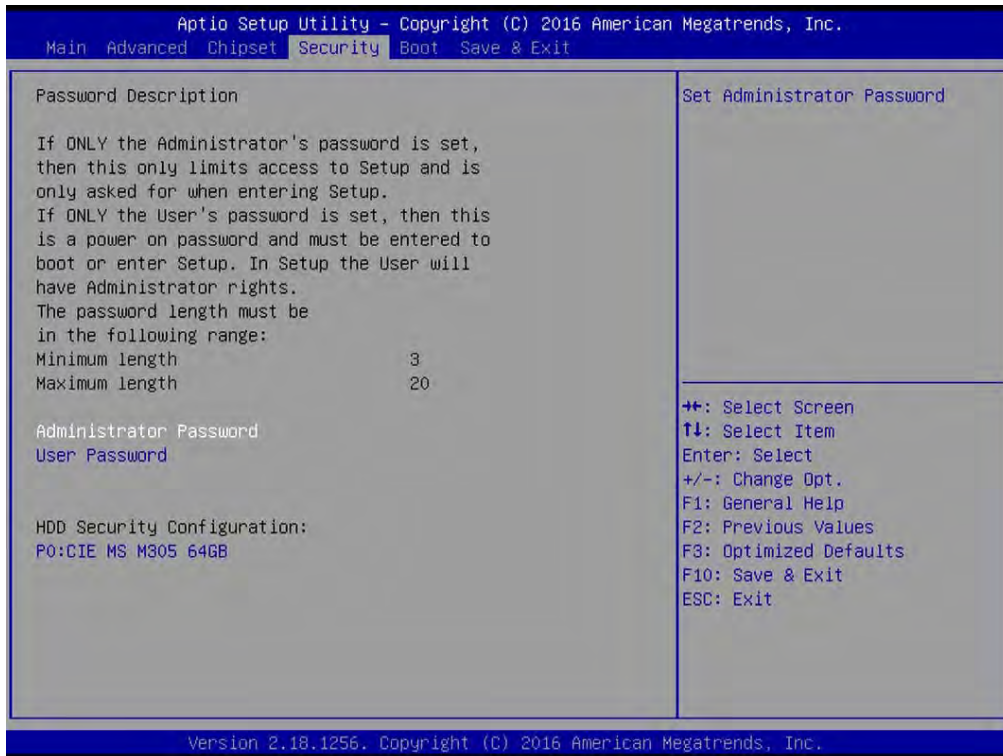

### 4.5.1 Administrator Password

Administrator Password controls access to the BIOS Setup utility.

### 4.5.2 User Password

User Password controls access to the system at boot and to the BIOS Setup utility.

### 4.5.3 HDD Security Configuration

Allows access to set, modify and clear HDD user and master password.

## 4.6 Boot Setup

This section allows you to configure Boot settings.

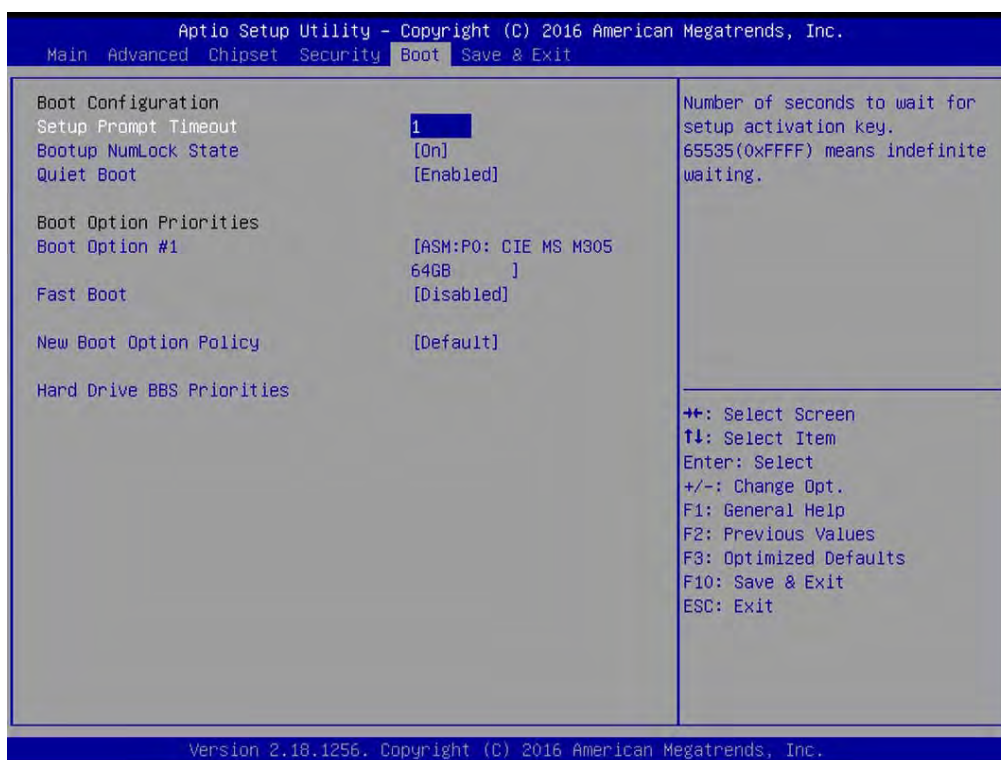

### 4.6.1 Setup Prompt Timeout [1]

Use this item to set number of seconds (1..65535) to wait for setup activation key.

### 4.6.2 Bootup NumLock State [On]

Allows you to select the power-on state for keyboard NumLock.

### 4.6.3 Quiet Boot [Enabled]

Allows you to enable or disable Quiet Boot function.

### 4.6.4 Boot Option #1

Allows you to change the boot order of devices attached to the system.

### 4.6.5 Fast Boot [Disabled]

Allows you to enable or disable Fast Boot function.

### 4.6.6 New Boot Option Policy [Default]

Allows you to change New Boot Option Policy.

Configuration options: [Default] [Place First] [Place Last].

### 4.6.7 Hard Drive BBS Priorities [Default]

Allows you to change the order of the legacy devices in the group.

## 4.7 Save & Exit



### 4.7.1 Save Changes and Exit

This item allows you to exit system setup after saving changes.

### 4.7.2 Discard Changes and Exit

This item allows you to exit system setup without saving changes.

### 4.7.3 Save Changes and Reset

This item allows you to reset the system after saving changes.

### 4.7.4 Discard Changes and Reset

This item allows you to reset system setup without saving any changes.

### 4.7.5 Save Changes

This item allows you to save changes done so far to any of the setup options.

### 4.7.6 Discard Changes

This item allows you to discard changes done so far to any of the setup options.

### 4.7.7 Restore Defaults

This item allows you to restore/ load default values for all the options.

### 4.7.8 Save as User Defaults

This item allows you to save the changes done so far as user defaults.

### 4.7.9 Restore User Defaults

This item allows you to restore the user defaults to all the options.

Chapter 5

# Product Application

## 5.1 Digital I/O (DIO) application

This section describes DIO application of the product. The content and application development are better understood and implemented by well experienced professionals or developers.

### 5.1.1 Digital I/O Programming Guide

#### 5.1.1.1 Pins for Digital I/O for PowerTwin series product

Item	Standard
GPIO70 (Pin103)	DI
GPIO71 (Pin104)	
GPIO72 (Pin105)	
GPIO73 (Pin106)	
GPIO74 (Pin107)	
GPIO75 (Pin108)	
GPIO76 (Pin109)	
GPIO77 (Pin110)	
GPIO80 (Pin111)	DO
GPIO81 (Pin112)	
GPIO82 (Pin113)	
GPIO83 (Pin114)	
GPIO84 (Pin115)	
GPIO85 (Pin116)	
GPIO86 (Pin117)	
GPIO87 (Pin118)	

### 5.1.1.2 Programming Guide

To program the Super I/O chip F81866A configuration registers, the following configuration procedures must be followed in sequence:

- (1) Enter the Extended Function Mode
- (2) Configure the configuration registers
- (3) Exit the Extended Function Mode

The configuration register is used to control the behavior of the corresponding devices. To configure the register, use the index port to select the index and then write data port to alter the parameters. The default index port and data port are 0x4E and 0x4F, respectively. **Pull down the SOUT1 pin to change the default value to 0x2E/ 0x2F. To enable configuration, the entry key 0x87 must be written to the index port. To disable configuration, write exit entry key 0xAA to the index port.** Following is an example to enable configuration and to disable configuration by using debug.

- o 4e 87
- o 4e 87 (enable configuration)
- o 4e aa (disable configuration)

### 5.1.1.3 Relative Registers

To program the F81866A configuration registers, see the following configuration procedures.

**Logic Device Number Register (LDN) — Index 07h**

Bit	Name	R/W	Reset	Default	Description
7-0	LDN	R/W	LRESET#	00h	00h: Select FDC device configuration registers. 03h: Select Parallel Port device configuration registers. 04h: Select Hardware Monitor device configuration registers. 05h: Select KBC device configuration registers. 06h: Select GPIO device configuration registers. 07h: Select WDT device configuration registers. 0Ah: Select PME, ACPI and ERP device configuration registers. 10h: Select UART1 device configuration registers. 11h: Select UART2 device configuration registers. 12h: Select UART3 device configuration registers. 13h: Select UART4 device configuration registers. 14h: Select UART5 device configuration registers. 15h: Select UART6 device configuration registers. Otherwise: Reserved.

**7.7.11.1 GPIO7 Output Enable Register — Index 80h**

Bit	Name	R/W	Reset	Default	Description
7	GPIO77_OE	R/W	LRESET#	0	0: GPIO77 is in input mode. 1: GPIO77 is in output mode.
6	GPIO76_OE	R/W	LRESET#	0	0: GPIO76 is in input mode. 1: GPIO76 is in output mode.
5	GPIO75_OE	R/W	LRESET#	0	0: GPIO75 is in input mode. 1: GPIO75 is in output mode.
4	GPIO74_OE	R/W	LRESET#	0	0: GPIO74 is in input mode. 1: GPIO74 is in output mode.
3	GPIO73_OE	R/W	LRESET#	0	0: GPIO73 is in input mode. 1: GPIO73 is in output mode.
2	GPIO72_OE	R/W	LRESET#	0	0: GPIO72 is in input mode. 1: GPIO72 is in output mode.
1	GPIO71_OE	R/W	LRESET#	0	0: GPIO71 is in input mode. 1: GPIO71 is in output mode.
0	GPIO70_OE	R/W	LRESET#	0	0: GPIO70 is in input mode. 1: GPIO70 is in output mode.

**7.7.11.2 GPIO7 Output Data Register — Index 81h (This byte could be also written by base address + 3)**

Bit	Name	R/W	Reset	Default	Description
7	GPIO77_VAL	R/W	LRESET#	1	0: GPIO77 outputs 0 when in output mode. 1: GPIO77 outputs 1 when in output mode.
6	GPIO76_VAL	R/W	LRESET#	1	0: GPIO76 outputs 0 when in output mode. 1: GPIO76 outputs 1 when in output mode.
5	GPIO75_VAL	R/W	LRESET#	1	0: GPIO75 outputs 0 when in output mode. 1: GPIO75 outputs 1 when in output mode.
4	GPIO74_VAL	R/W	LRESET#	1	0: GPIO74 outputs 0 when in output mode. 1: GPIO74 outputs 1 when in output mode.
3	GPIO73_VAL	R/W	LRESET#	1	0: GPIO73 outputs 0 when in output mode. 1: GPIO73 outputs 1 when in output mode.
2	GPIO72_VAL	R/W	LRESET#	1	0: GPIO72 outputs 0 when in output mode. 1: GPIO72 outputs 1 when in output mode.
1	GPIO71_VAL	R/W	LRESET#	1	0: GPIO71 outputs 0 when in output mode. 1: GPIO71 outputs 1 when in output mode.
0	GPIO70_VAL	R/W	LRESET#	1	0: GPIO70 outputs 0 when in output mode. 1: GPIO70 outputs 1 when in output mode.

#### 7.7.12.1 GPIO8 Output Enable Register — Index 88h

Bit	Name	R/W	Reset	Default	Description
7	GPIO87_OE	R/W	LRESET#	0	0: GPIO87 is in input mode. 1: GPIO87 is in output mode.
6	GPIO86_OE	R/W	LRESET#	0	0: GPIO86 is in input mode. 1: GPIO85 is in output mode.

5	GPIO85_OE	R/W	LRESET#	0	0: GPIO85 is in input mode. 1: GPIO85 is in output mode.
4	GPIO84_OE	R/W	LRESET#	0	0: GPIO84 is in input mode. 1: GPIO84 is in output mode.
3	GPIO83_OE	R/W	LRESET#	0	0: GPIO83 is in input mode. 1: GPIO83 is in output mode.
2	GPIO82_OE	R/W	LRESET#	0	0: GPIO82 is in input mode. 1: GPIO82 is in output mode.
1	GPIO81_OE	R/W	LRESET#	0	0: GPIO81 is in input mode. 1: GPIO81 is in output mode.
0	GPIO80_OE	R/W	LRESET#	0	0: GPIO80 is in input mode. 1: GPIO80 is in output mode.

#### 7.7.12.2 GPIO8 Output Data Register — Index 89h (This byte could be also written by base address + 2)

Bit	Name	R/W	Reset	Default	Description
7	GPIO87_VAL	R/W	LRESET#	1	0: GPIO87 outputs 0 when in output mode. 1: GPIO87 outputs 1 when in output mode.
6	GPIO86_VAL	R/W	LRESET#	1	0: GPIO86 outputs 0 when in output mode. 1: GPIO86 outputs 1 when in output mode.
5	GPIO85_VAL	R/W	LRESET#	1	0: GPIO85 outputs 0 when in output mode. 1: GPIO85 outputs 1 when in output mode.
4	GPIO84_VAL	R/W	LRESET#	1	0: GPIO84 outputs 0 when in output mode. 1: GPIO84 outputs 1 when in output mode.
3	GPIO83_VAL	R/W	LRESET#	1	0: GPIO83 outputs 0 when in output mode. 1: GPIO83 outputs 1 when in output mode.
2	GPIO82_VAL	R/W	LRESET#	1	0: GPIO82 outputs 0 when in output mode. 1: GPIO82 outputs 1 when in output mode.
1	GPIO81_VAL	R/W	LRESET#	1	0: GPIO81 outputs 0 when in output mode. 1: GPIO81 outputs 1 when in output mode.
0	GPIO80_VAL	R/W	LRESET#	1	0: GPIO80 outputs 0 when in output mode. 1: GPIO80 outputs 1 when in output mode.



#### 5.1.1.4 Sample Code in C Language

##### 5.1.1.4 .1 Control of GP70 to GP77

```
#define AddrPort 0x4E  
#define DataPort 0x4F
```

<Enter the Extended Function Mode>

```
WriteByte(AddrPort, 0x87)  
WriteByte(AddrPort, 0x87) // Must write twice to enter Extended mode
```

<Select Logic Device>

```
WriteByte(AddrPort, 0x07)  
WriteByte(dataPort, 0x06)  
//Select logic device 06h
```

<Output/Input Mode Selection> // Set GP70 to GP77 input Mode

```
WriteByte(AddrPort, 0x80) // Select configuration register 80h  
WriteByte(DataPort, (ReadByte(DataPort) | 0x00))  
// Set (bit 0~7) = 0 to select GP 70~77 as Input mode.
```

<Input Value>

```
WriteByte(AddrPort, 0x81) // Select configuration register 81h  
ReadByte(DataPort, Value) // Read bit 0~7 (0xFF)= GP70 ~77  
as High.
```

<Leave the Extended Function Mode>

```
WriteByte(AddrPort, 0xAA)
```

#### 5.1.1.4 .2 Control of GP80 to GP87

```
#define AddrPort 0x4E  
#define DataPort 0x4F
```

<Enter the Extended Function Mode>

```
WriteByte(AddrPort, 0x87)  
WriteByte(AddrPort, 0x87) // Must write twice to enter Extended mode
```

<Select Logic Device>

```
WriteByte(AddrPort, 0x07)  
WriteByte(DataPort, 0x06)  
// Select logic device 06h
```

<Output/Input Mode Selection> // Set GP80 to GP87 output Mode

```
WriteByte(AddrPort, 0x88) // Select configuration register 88h  
WriteByte(DataPort, (ReadByte(DataPort) & 0xFF))  
// Set (bit 0~7) = 1 to select GP 80 ~87 as Output mode.
```

<Output Value>

```
WriteByte(AddrPort, 0x89) // Select configuration register 89h  
WriteByte(DataPort, Value) // Set bit 0~7=(0/1) to output GP 80~87  
as Low or High
```

<Leave the Extended Function Mode>

```
WriteByte(AddrPort, 0xAA)
```

### 5.1.1.5 Change base address

<Enter the Extended Function Mode>

WriteByte(AddrPort, 0x87)

WriteByte(AddrPort, 0x87) // Must write twice to enter Extended mode

<Select Logic Device>

WriteByte(AddrPort, 0x07)

WriteByte(dataPort, 0x06)

// Select logic device 06h

WriteByte(AddrPort, 0x60) // Select configuration register 60h

WriteByte(DataPort, (ReadByte(DataPort) | 0x03))

WriteByte(AddrPort, 0x61) // Select configuration register 61h

WriteByte(DataPort, (ReadByte(DataPort) | 0x20))

<Leave the Extended Function Mode>

WriteByte(AddrPort, 0xAA)

default GPIO Port base address is 0xA00h

### 5.1.1.6 DATA Bit Table (DIO)

7	6	5	4	3	2	1	0	bit
0	0	0	1	0	0	0	0	value
1				0				/h

= DI1

7	6	5	4	3	2	1	0	bit
0	0	0	0	0	0	0	1	value
0				1				/h

= DO1

7	6	5	4	3	2	1	0	bit
0	0	1	0	0	0	0	0	value
2			0					/h

= DI2

7	6	5	4	3	2	1	0	bit
0	0	0	0	0	0	1	0	value
0				2				/h

= DO2

7	6	5	4	3	2	1	0	bit
0	1	0	0	0	0	0	0	value
4			0					/h

= DI3

7	6	5	4	3	2	1	0	bit
0	0	0	0	0	1	0	0	value
0				4				/h

= DO3

7	6	5	4	3	2	1	0	bit
1	0	0	0	0	0	0	0	value
8				0				/h

= DI4

7	6	5	4	3	2	1	0	bit
0	0	0	0	1	0	0	0	value
0				8				/h

= DO4

### 5.1.1.7 DIO I/O Port Address

DI8	DI7	DI6	DI5	DI4	DI3	DI2	DI1	DO8	DO7	DO6	DO5	DO4	DO3	DO2	DO1	Pin Definition
7	6	5	4	3	2	1	0	7	6	5	4	3	2	1	0	Data Bits
DI								DO								DIO
0xA03								0xA02								I/O Port address

## 5.2 Digital I/O (DIO) Hardware Specification

- XCOM+ / 2XCOM+ : Isolated power in V+
- XCOM- / 2XCOM- : Isolated power in V-
- Isolated power in DC voltage : 9~30V
- 8x / 16x Digital Input (Source Type)
- Input Signal Voltage Level
  - Signal Logic 0 : XCOM+ = 9V, Signal Low - V- < 1V  
XCOM+ > 9V, V+ - Signal Low > 8V
  - Signal Logic 1 : > XCOM+ - 3V
- Input Driving Sink Current :
  - Minimal : 1 mA
  - Normal : 5 mA
- 8x / 16x Digital Output (Open Drain)
  - DO Signal have to pull up resistor to XCOM+ for external device, the resistance will affect the pull up current
  - Signal High Level : Pull up resistor to XCOM+
  - Signal Low Level : = XCOM-
  - Sink Current: 1A (Max)

## 5.2.1 DIO Connector Definition

### DIO1/DIO2 : Digital Input / Output Connector

Connector Type: Terminal Block 2X10 10-pin, 3.5mm pitch

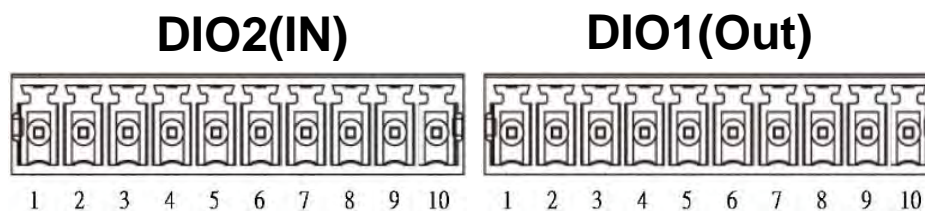

Pin	Definition	Pin	Definition
1	DC INPUT	1	DC INPUT
2	DI1	2	DO1
3	DI2	3	DO2
4	DI3	4	DO3
5	DI4	5	DO4
6	DI5	6	DO5
7	DI6	7	DO6
8	DI7	8	DO7
9	DI8	9	DO8
10	GND	10	GND

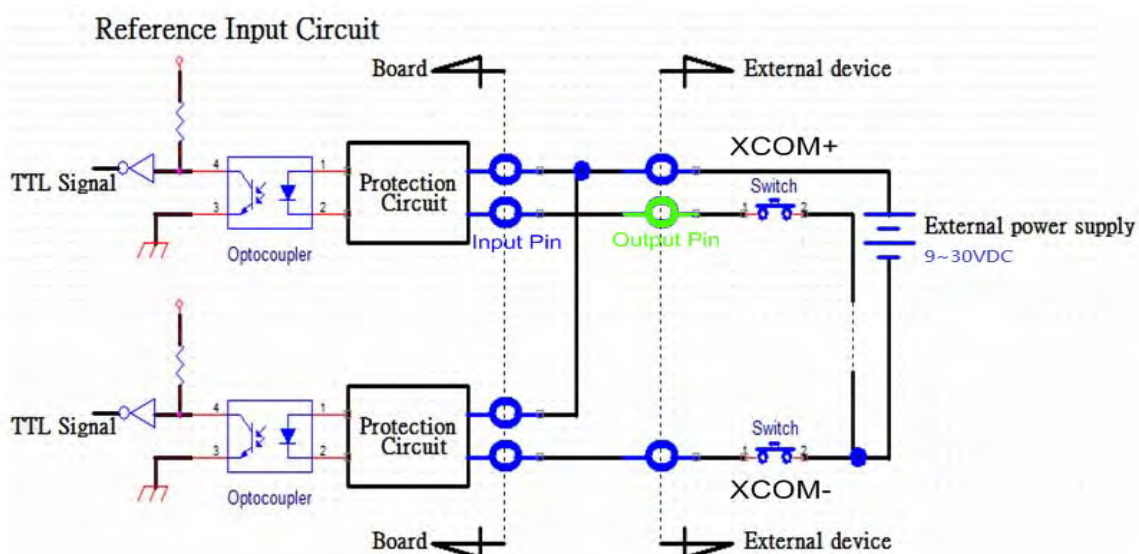

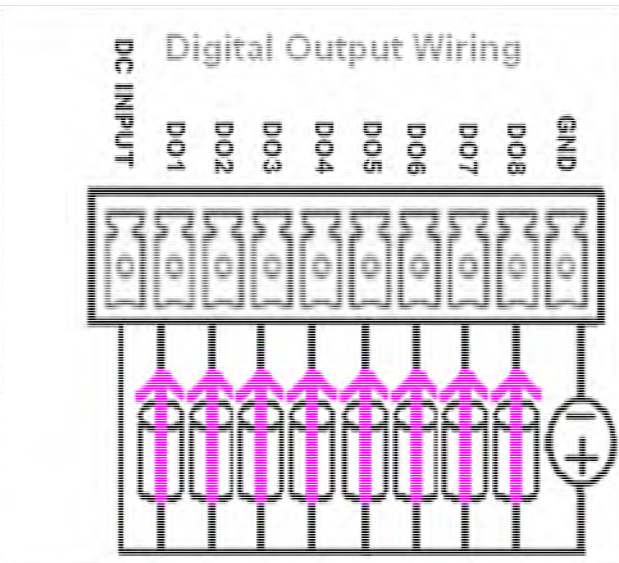
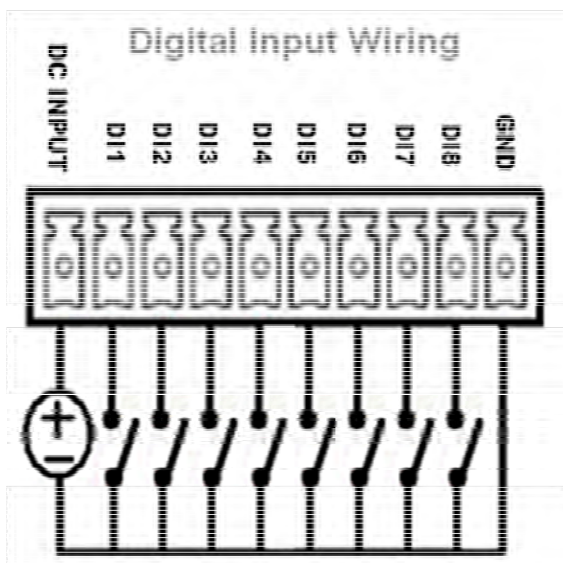
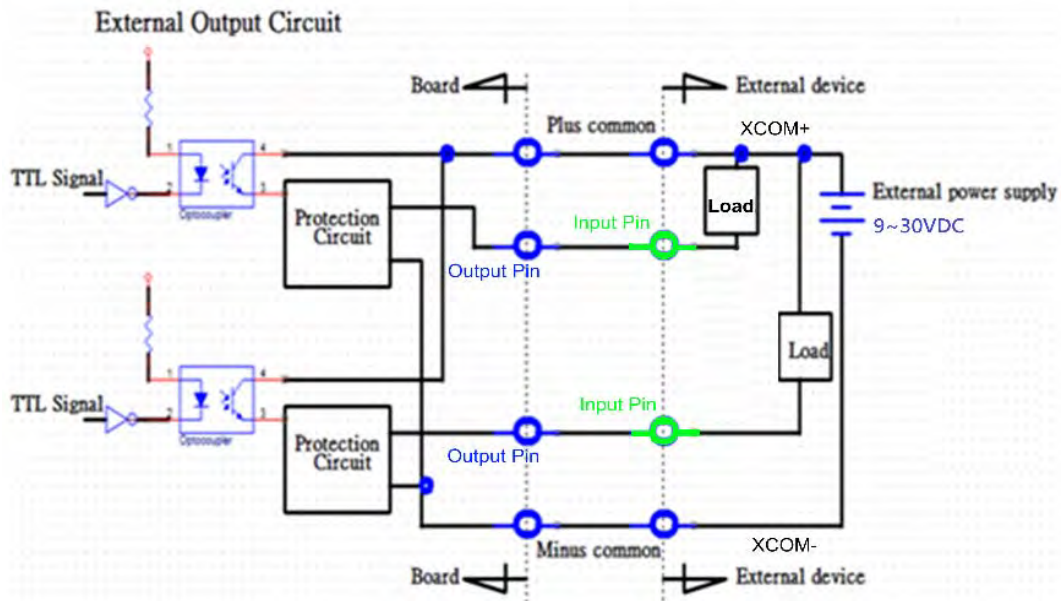

Powered by individuality



**Spectra GmbH & Co. KG**

Mahdenstr. 3  
72768 Reutlingen  
Germany

Phone +49 (0) 7121 1432-10  
E-Mail [info@spectra.de](mailto:info@spectra.de)  
Web [www.spectra.de](http://www.spectra.de)



**Spectra GmbH & Co. KG**

Gewerbepark Ost 1  
4621 Sipbachzell (Wels)  
Austria

Phone +43 (0) 7240 20190  
E-Mail [info@spectra-austria.at](mailto:info@spectra-austria.at)  
Web [www.spectra-austria.at](http://www.spectra-austria.at)



**Spectra (Schweiz) AG**

Flugplatzstr. 5  
8404 Winterthur  
Switzerland

Phone +41 (0) 43 2771050  
E-Mail [info@spectra.ch](mailto:info@spectra.ch)  
Web [www.spectra.ch](http://www.spectra.ch)

**Sales Industrial PC Systems**

Phone +49 (0) 7121 1432-165  
E-Mail [vertrieb@spectra.de](mailto:vertrieb@spectra.de) / [sales@spectra.de](mailto:sales@spectra.de)



All other logos appearing in this catalog are the intellectual property of the respective company, product, or organization associated with the logo. All product specifications and information are subject to change without notice.

© spectra 2019