

# LV-67P

---

## Mini-ITX Motherboard

### User's Manual

Edition 1.0  
2016/06/13



---

## Copyright

Copyright 2015, all rights reserved. This document is copyrighted and all rights are reserved. The information in this document is subject to change without prior notice to make improvements to the products.

This document contains proprietary information and protected by copyright. No part of this document may be reproduced, copied, or translated in any form or any means without prior written permission of the manufacturer.

All trademarks and/or registered trademarks contains in this document are property of their respective owners.

## Disclaimer

The company shall not be liable for any incidental or consequential damages resulting from the performance or use of this product.

The company does not issue a warranty of any kind, express or implied, including without limitation implied warranties of merchantability or fitness for a particular purpose.

The company has the right to revise the manual or include changes in the specifications of the product described within it at any time without notice and without obligation to notify any person of such revision or changes.

## Trademark

All trademarks are the property of their respective holders.

---

Any questions please visit our website at <http://www.commell.com.tw>

## Packing List:

Please check the package content before you starting using the board.



1 x LV-67P Motherboard



2 x SATA Cable  
(OALSATA3-L) / (1040529)

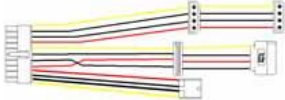

1 x Power Cable  
(OALATX-P3S2 / 1040058)



1 x VGA Cable  
(OALVGA-SNB-7) / (1040557)

LV-67PNT & LV-67PET ONLY



1 x DC Power Cable  
(OALDC-A) / (1040433)

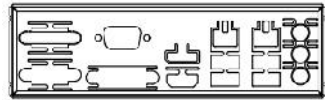

1 x I/O Shield  
(OPLATE-CDILAT) / (1270067)  
(OPLATE-CDILA) / (1270068)

(OPLATE-CDILAT for LV-67PNT & LV-67PET)

## Optional:

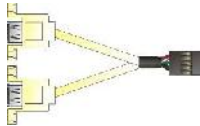

1 x USB2.0 cable  
(OALUSBA-3) / (1040173)

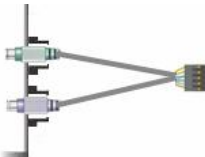

1 x PS/2 Keyboard & Mouse cable  
(OALPS2/KMB) / (1040610)

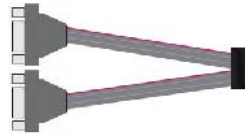

1 x Dual COM cable  
(OALES-BKU2NB) / (1040090)

## Printed Matters:

Driver CD x 1 (Including User's Manual)

## Index

<b>Chapter 1 &lt;Introduction&gt;</b> .....	<b>4</b>
1.1 <Product Overview> .....	4
1.2 <Product Specification> .....	5
1.3 <Block Diagram> .....	6
<b>Chapter 2 &lt;Hardware setup&gt;</b> .....	<b>7</b>
2.1 <Connector Location and Reference> .....	7
2.1.1 <Internal connectors list> .....	8
2.1.2 <External connectors list> .....	8
2.2 <Jumper Location and Reference> .....	9
2.2.1 <Jumper list> .....	9
2.2.2 <Clear CMOS and Power on type selection> .....	10
2.3 <Installing the Memory> .....	10
2.4 <I/O interface> .....	11
2.4.1 <Serial ATA interface> .....	11
2.4.2 <Ethernet interface> .....	11
2.4.3 <Display interface> .....	12
2.4.4 <Serial Port interface> .....	14
2.4.5 <USB interface> .....	16
2.4.6 <Audio interface> .....	17
2.4.7 <Expansion slot> .....	18
2.4.8 <Front panel switch and indicator> .....	18
2.4.9 <Other interface> .....	19
2.5 <Power supply> .....	21
2.5.1 <Power input> .....	21
<b>Appendix A &lt;Flash BIOS&gt;</b> .....	<b>22</b>
A.1 BIOS Auto Flash Tool .....	22
A.2 Flash Method .....	22
<b>Appendix B &lt;LCD Panel Type select&gt;</b> .....	<b>24</b>
<b>Appendix C &lt;Programmable Watch Dog Timer&gt;</b> .....	<b>25</b>
<b>Contact information</b> .....	<b>26</b>

# Chapter 1 <Introduction>

## 1.1 <Product Overview>

**LV-67P** is mini-ITX Motherboard which is design based on Intel® Pentium® Processor N3000 Series Processor(Braswell SoC), delivering outstanding compute, graphical, and media performance while operating in an extended range of thermal conditions. The SoC bases on the Silvermont microarchitecture, utilizing Intel's industry-leading 14nm process technology with 3-D Tri-Gate transistors, which deliver significant improvements in computational performance and energy efficiency.

### **New features for Intel® Pentium® N3000 Series Processor**

The Intel® Pentium® N3000 Series Processor has a lower TDP 6W, it provides new HD Graphics to support triple display, 4K resolution, maximum memory size is up to 8GB of DDR3L, and more enhanced security that is suitable for a variety of intelligent systems the ideal choice.

### **All in One multimedia solution**

The board provides high performance onboard graphics, 18/24-bit single/dual channel LVDS interface, DisplayPort, HDMI, and High Definition Audio, to meet the very requirement of the multimedia application.

### **Flexible Expansion Interface**

The board provides one MiniPCIe and one mSATA.

### **Braswell remove EHCI**

When you install WIN7 with USB device(CDROM, Keyboard, Mouse...), Windows7 can not identify your usb device. You can use SATA CD-ROM and PS/2 to install Windows7.

## 1.2 <Product Specification>

### System

Processor	Intel® Braswell Series Processor N3710/X5-E8000, FCBGA1170 package
Chipset	Braswell SoC
Memory	2 x DDR3L DIMM 1600 MHz up to 8GB, Support Non-ECC, unbuffered memory only  (If you only use one DDR3L SO-DIMM, install memory on SO-DIMM1) (if you use two DDR3L SO-DIMM, need same memory) (Same memory means same capacity, same topology same raw card type.)
Watchdog Timer	Generates a system reset with internal timer for 1min/s ~ 255min/s
Real Time Clock	Chipset integrated RTC with onboard lithium battery
Expansion	1 x MiniPCIe, 1 x PCIE X16 slot, 1 x Sim slot 1 x mSATA (same signal with SATA3-2)

### Graphics

Chipset	Intel® HD Graphics
Display Interface	1 x DVI, 1 x HDMI, 1 x LVDS/CRT/DisplayPort(Optional)

### LAN

Chip	2 x Intel® I210-AT Gigabit LAN
------	--------------------------------

### I/O

Serial ATA	2 x SATA3  (SATA3-2 cannot use when JMSATA 's jumper cap on pin1 and pin2)
Audio	Realtek ALC262 HD Audio
Internal I/O	2 x SATA3, 4 x RS232, 2 x USB2.0, 1 x LPC 1 x GPIO , 1 x PS/2, 1 x SMBUS, 1 x LVDS(Optional), 1 x CRT(Optional), 1 x LCD inverter, 1 x Audio.
Rear I/O	4 x USB3.0, 2 x LAN, 1 x HDMI, 1 x DisplayPort(Optional) , 1 x RS232, 1 x RS232/422/485

### Mechanical & Environmental

Power Requirement	Standard 24-pin ATX power supply or 4-pin 6~30V
Size & Thickness	170mm x 170mm (L x W)
Temperature	Operating within 0°C~60°C (32°F~140°F) Storage within -20°C~80°C (-4°F~176°F)
Relative Humidity	10%~90%, non-condensing

# 1.3 <Block Diagram>

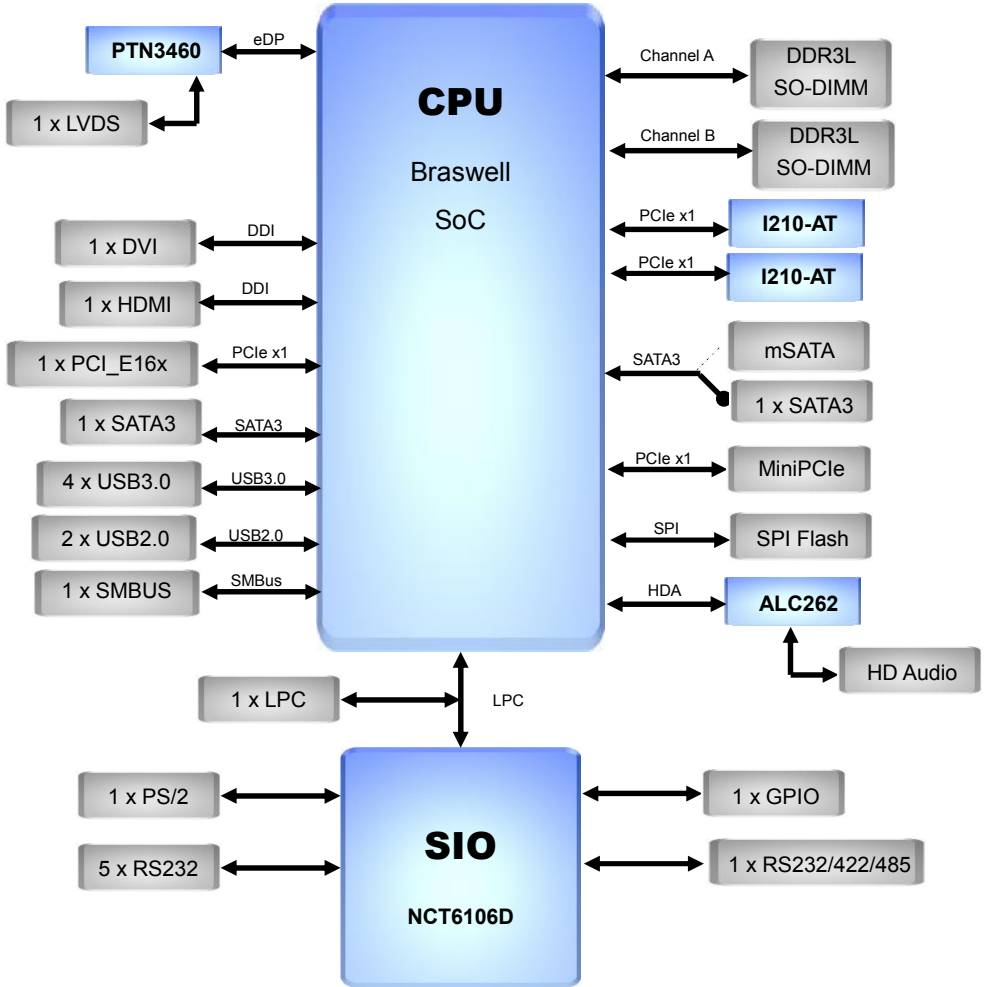

# Chapter 2 <Hardware setup>

## 2.1 <Connector Location and Reference>

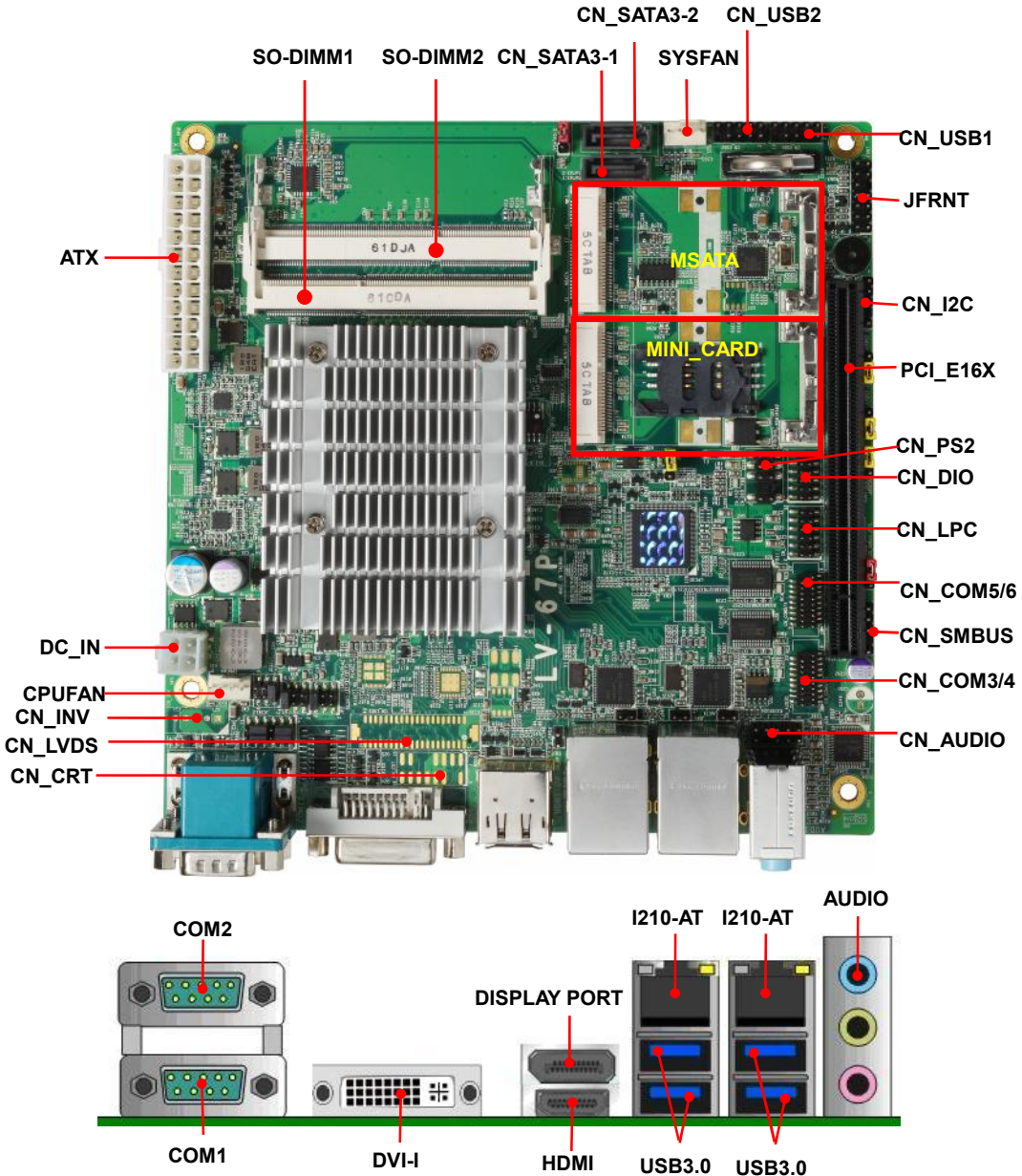



## 2.1.1 <Internal connectors list>

Connector	Function
SO-DIMM1/2	204-pin DDR3L SO-DIMM slot
CN_SATA3-1/2	10-pin Serial ATA3 connector
CN_AUDIO	5 x 2-pin audio pin header
CN_LPC	6 x 2-pin LPC pin header
CN_DIO	6 x 2-pin digital I/O connector
CN_LVDS	20 x 2-pin LVDS connector
CN_INV	5-pin LCD inverter connector
CN_SMBUS	5-pin SMBus connector
CN_I2C	5-pin I2C connector
CN_COM 3/4 5/6	19-pin RS232 connector
CN_USB1/2	5 x 2-pin USB2.0 pin header
CN_PS2	5 x 2-pin PS/2 pin header
CPUFAN	4-pin CPU fan connector
SYSFAN	4-pin system fan connector
JFRNT	5 x 2-pin front panel switch/indicator pin header
MINI_CARD	52-pin MiniPCIe card slot
MSATA	52-pin MSATA card slot
SIMM	6-pin socket
ATX	24-pin power supply connector
DC_IN	4-pin power input Terminal Block

## 2.1.2 <External connectors list>

Connector	Function
DisplayPort	DisplayPort connector
DVI-I	DVI connector
HDMI	HDMI connector
USB3.0	4 x USB3.0 connector
LAN	2 x RJ45 LAN connector
AUDIO	Audio connector
COM1/2	DB9 Serial port connector

## 2.2 <Jumper Location and Reference>

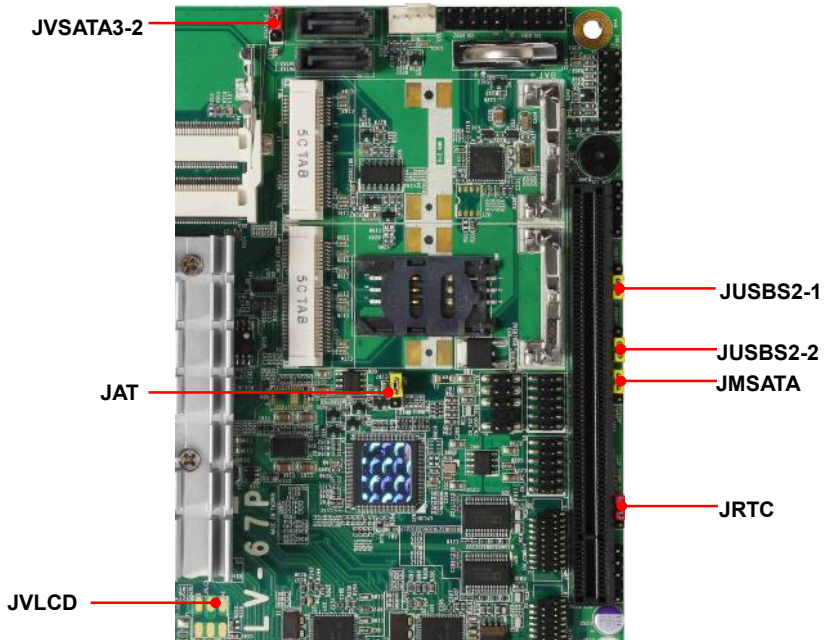

### 2.2.1 <Jumper list>

Jumper	Function
JAT	Power mode select
JRTC	CMOS Normal/Clear Setting
JVLCD	Panel Voltage Setting
JMSATA	MiniCard Msata Setting
JVSATA3-2	Set 5V to SATA3-2 pin 7 (For SATADOM)
JUSBS2-1	Set USB signal to minicard
JUSBS2-2	Set USB signal to MSATA

## 2.2.2 <Clear CMOS and Power on type selection>

JRTC: Clear CMOS data jumper

Jumper settings	Function
1-2	Clear CMOS
2-3	Normal (Default)

JAT: AT/ATX mode select jumper

Jumper settings	Function
1-2	AT mode
2-3	ATX mode (Default)

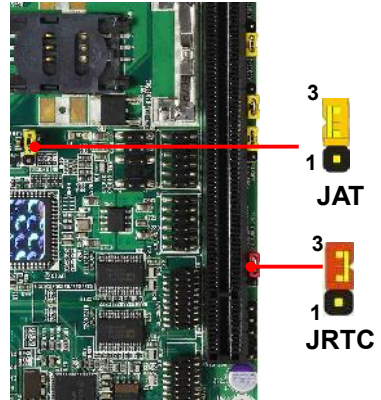

## 2.3 <Installing the Memory>

**In the process, the board must be powered off.**

1. Put the memory tilt into the slot. Note the Memory notch key aligned slot key.
2. Then press down till lock into the mounting notch.

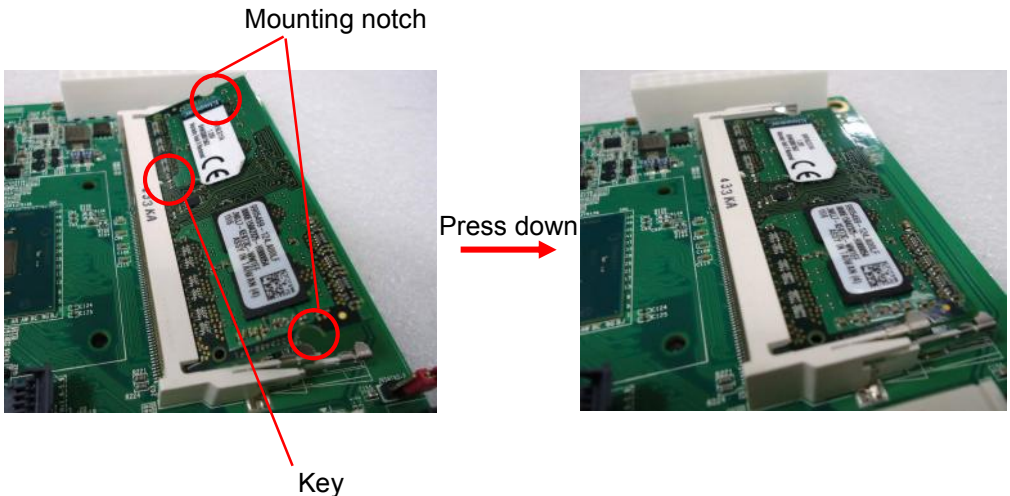

- To remove the memory, push outward on both sides of the latch.

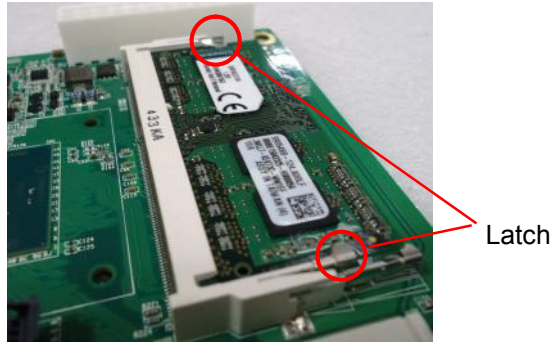

## 2.4 <I/O interface>

### 2.4.1 <Serial ATA interface>

**SATA3-1/2:** SATA3 7-pin connector

Pin	Signal
1	GND
2	TX+
3	TX-
4	GND
5	RX-
6	RX+
7	GND

**JVSATA3-2**



**SATA3-2**

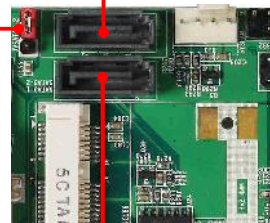

**SATA3-1**

**JVSATA3-2:** SATA3/SATADOM mode select jumper (change pin7 to 5V)

Jumper settings	Function
1-2	SATA3-2 SATADOM
2-3	SATA3-2 SATA3 (Default)

### 2.4.2 <Ethernet interface>

The board provide I210-AT Gigabit Ethernet which supports WOL rear I/O.

Find the setting from

Advanced-----> Power Management--> Wake on LAN Enable [Disable] (default)

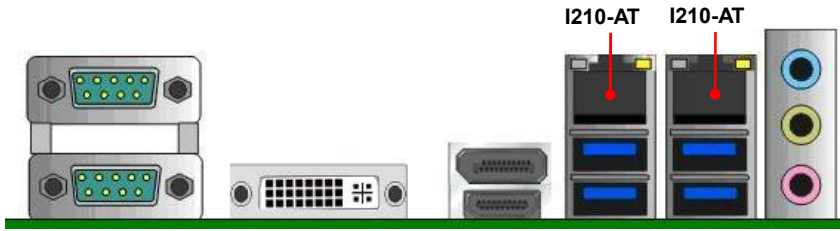

### 2.4.3 <Display interface>

Based on the Braswell SoC with built-in HD Graphics, the DVI up to **1920x1080@60Hz**, the DisplayPort up to **3840x2160 @ 30Hz**, the HDMI resolution up to **3840x2160 @ 30Hz** and LVDS (PTN3460) up to **1920x1200 @ 60Hz** support 18/24-bit color depth and single/dual channel. About select LCD Panel Type in BIOS, please refer **Appendix B**. The built-in HD Graphics support triple display function with clone mode and extended mode.

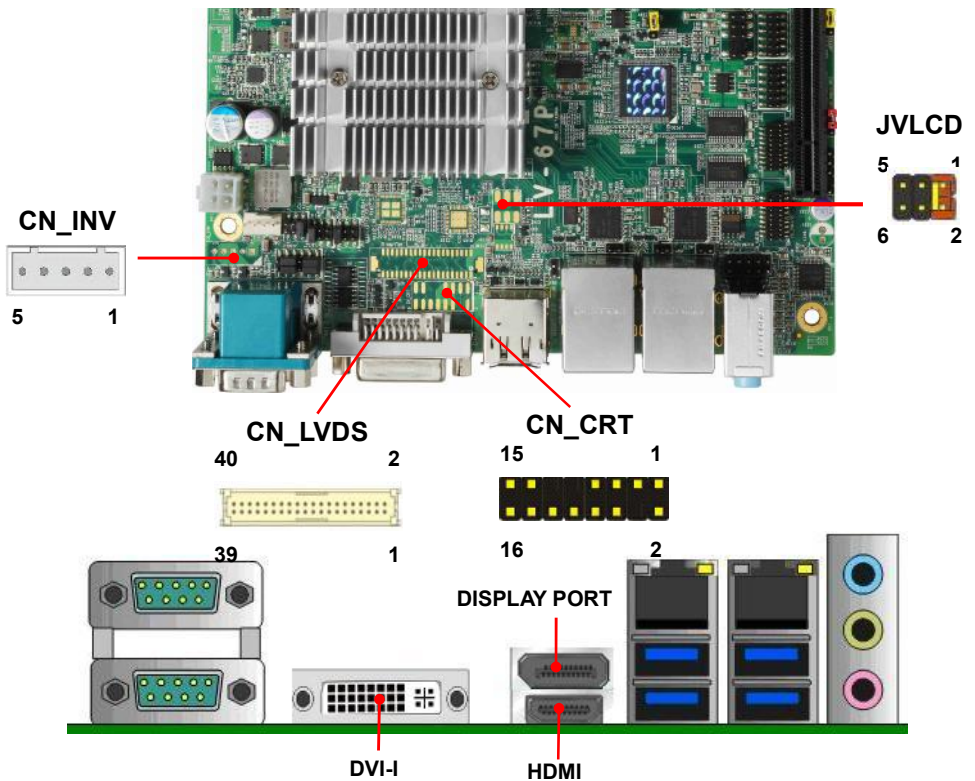

**JVLCD:** LVDS panel power select jumper

Jumper settings	Function
1-2	3.3V (Default)
2-3	5V
5-6	12V

**CN\_LVDS:** LVDS 40-pin connector (Model: HIROSE DF13-40DP-1.25V compatible)

Pin	Signal	Pin	Signal
2	Set by JVLCD	1	Set by JVLCD
4	Detect (Active low)	3	GND
6	A_LVDS_0-	5	B_LVDS_0-
8	A_LVDS_0+	7	B_LVDS_0+
10	GND	9	GND
12	A_LVDS_1-	11	B_LVDS_1-
14	A_LVDS_1+	13	B_LVDS_1+
16	GND	15	GND
18	A_LVDS_2-	17	B_LVDS_2-
20	A_LVDS_2+	19	B_LVDS_2+
22	GND	21	GND
24	A_LVDS_CLK-	23	B_LVDS_3-
26	A_LVDS_CLK+	25	B_LVDS_3+
28	GND	27	GND
30	A_LVDS_3-	29	B_LVDS_CLK-
32	A_LVDS_3+	31	B_LVDS_CLK+
34	GND	33	GND
36	LVDS_DDCSCL	35	NC
38	LVDS_DDCSDA	37	NC
40	NC	39	NC

**Note: Pin4 only need to be connected to GND**

**CN\_INV:** LVDS 5-pin Backlight power connector

Pin	Signal
1	12V
2	Backlight Control
3	GND`
4	GND
5	Enable Backlight

**CN\_CRT**: CRT 16-pin connector (Pitch 2.00 mm)

Pin	Signal	Pin	Signal
1	BR	2	BG
3	BB	4	NC
5	IOGND1	6	IOGND1
7	IOGND1	8	IOGND1
9	NC	10	IOGND1
11	NC	12	5VCDA
13	5HSYNC	14	5VSYNC
15	5VCLK	16	NC

### 2.4.4 <Serial Port interface>

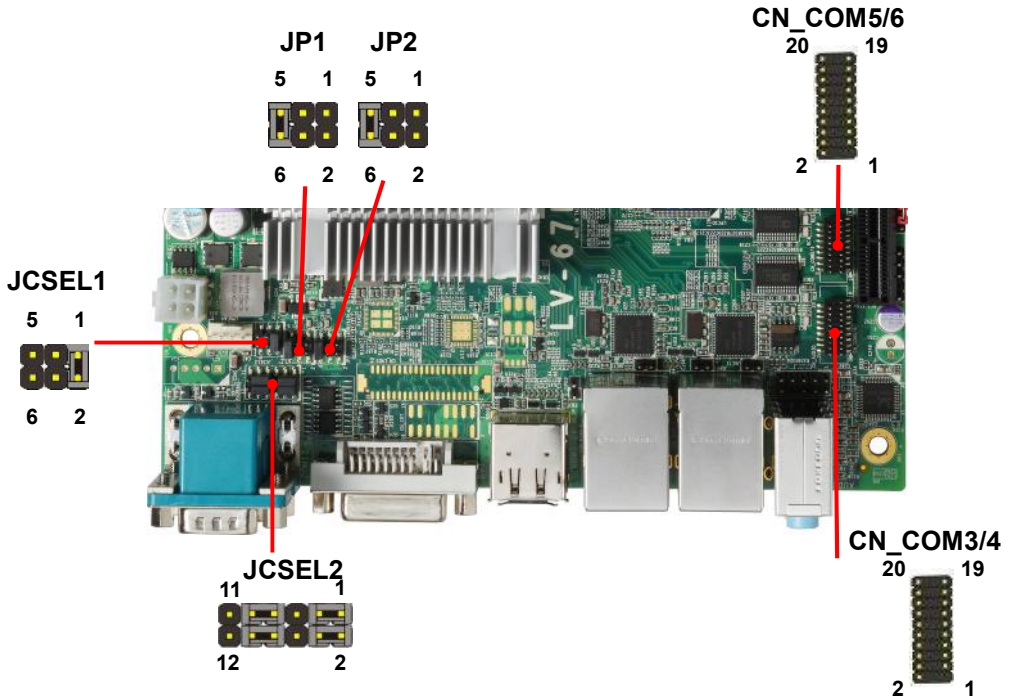

**COM1**: RS232 DB9 connector

Pin	Signal	Pin	Signal
1	DCD	2	RXD
3	TXD	4	DTR
5	GND	6	DSR
7	RTS	8	CTS
9	Set by JP2	10	Key



**COM2: RS232/422/485 DB9 connector**

Pin	Signal	Pin	Signal
1	DCD/ 422TX-/ 485-	2	RXD/ 422TX+/ 485+
3	TXD/ 422RX+	4	DTR/ 422RX-
5	GND	6	DSR
7	RTS	8	CTS
9	Set by JP1		

**Note: Use JCSEL1 and JCSEL2 to select communication mode**

**CN\_COM3/4,5/6: RS232 20-pin header (Pitch 1.27mm x 2.54mm)**

Pin	Signal	Pin	Signal
1	DCD1	2	RXD1
3	TXD1	4	DTR1
5	GND	6	DSR1
7	RTS1	8	CTS1
9	RI1	10	NC
11	DCD2	12	RXD2
13	TXD2	14	DTR2
15	GND	16	DSR2
17	RTS2	18	CTS2
19	RI2	20	Key

**JP1, JP2: COM1, COM2 pin-9 setting**

Jumper settings	Function
1-2	5V
3-4	12V
5-6	RI (Default)

**Effective patterns of connection: 1-2 / 3-4 / 5-6**

**Other may cause damage**



JCSEL1, JCSEL2: For configure COM2 communication mode

Function	JCSEL1	JCSEL2
RS232		
RS485		
RS422		

### 2.4.5 <USB interface>

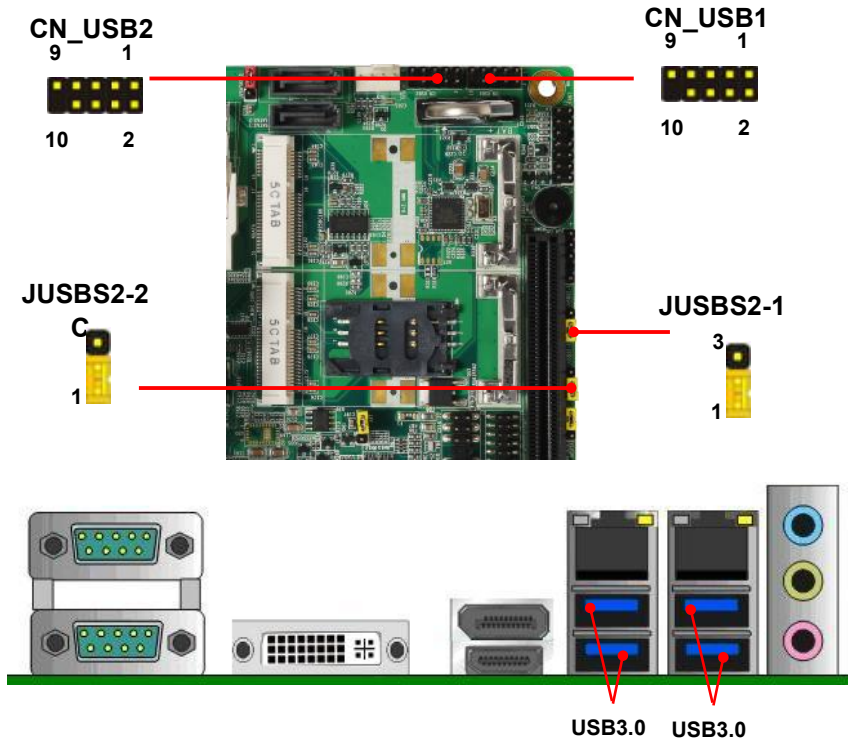

**CN\_USB:** Front panel USB2.0 10-pin header (Pitch 2.54mm)

Pin	Signal	Pin	Signal
1	5VSB	2	5VSB
3	DATA0-	4	DATA1-
5	DATA0+	6	DATA1+
7	GND	8	GND
9	GND	10	Key

**JUSBS2-1:** Minicard usb signal setting

Jumper settings	Function
1-2	CN_USB1 can work (Default)
2-3	Change USB signal to minicard (PIN36 &38)

**JUSBS2-2:** MSATA usb signal setting

Jumper settings	Function
1-2	CN_USB1 can work (Default)
2-3	Change USB signal to MSATA (PIN36 &38)

## 2.4.6 <Audio interface>

**CN\_AUDIO**

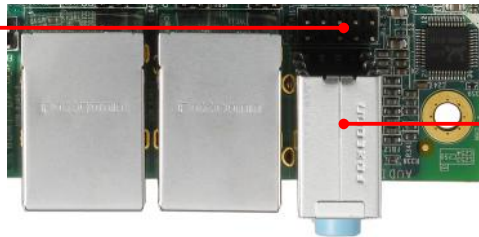
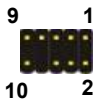

**Rear Audio Jack**



**CN\_AUDIO:** Front panel audio 10-pin header (Pitch 2.54mm)

Pin	Signal	Pin	Signal
1	MIC_L	2	GND
3	MIC_R	4	NC
5	FP_OUT_R	6	MIC_DETECT
7	SENSE	8	Key
9	FP_OUT_L	10	FP_OUT_DETECT

## 2.4.7 <Expansion slot>

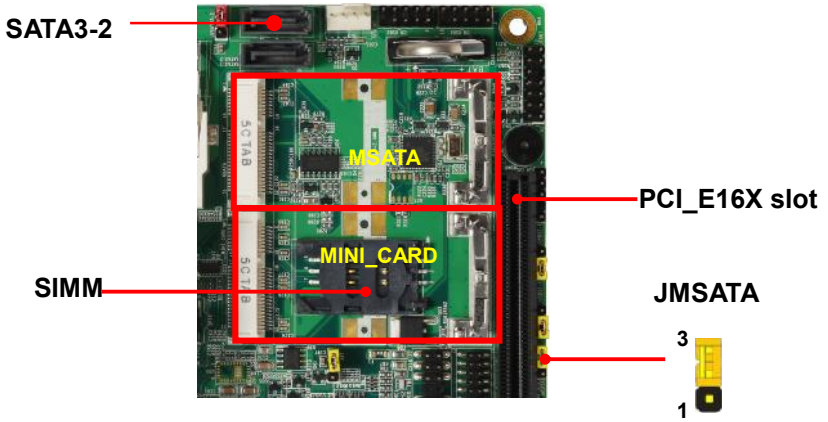

MINI\_CARD connect SIM card with 3G module.

**JMSATA:** Setting MSATA to support mSATA

Jumper settings	Function
1-2	Support mSATA, and SATA3-2 cannot work
2-3	SATA3-2 can work, and MSATA cannot work(Default)

**PCI\_E16X slot:** 16-lane (×16) links, but run 1x speed

## 2.4.8 <Front panel switch and indicator>

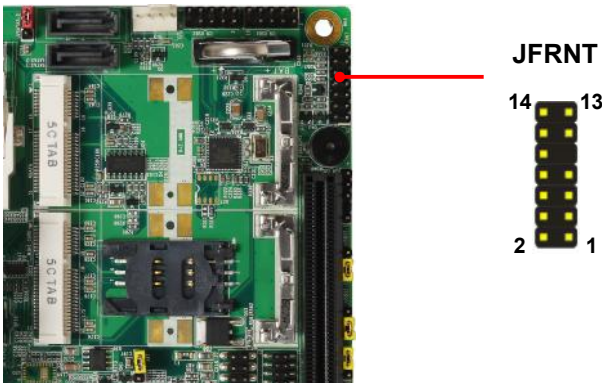

**JFRNT:** Front panel switch and indicator 14-pin header (Pitch 2.54mm)

Pin	Signal	Pin	Signal
1	HDD_LED+	2	Power_LED+
3	HDD_LED-	4	NC
5	Reset+	6	Power_LED-
7	Reset-	8	Speaker+
9	Key	10	NC
11	Power_ON+	12	NC
13	Power_ON-	14	Speaker-

### 2.4.9 <Other interface>

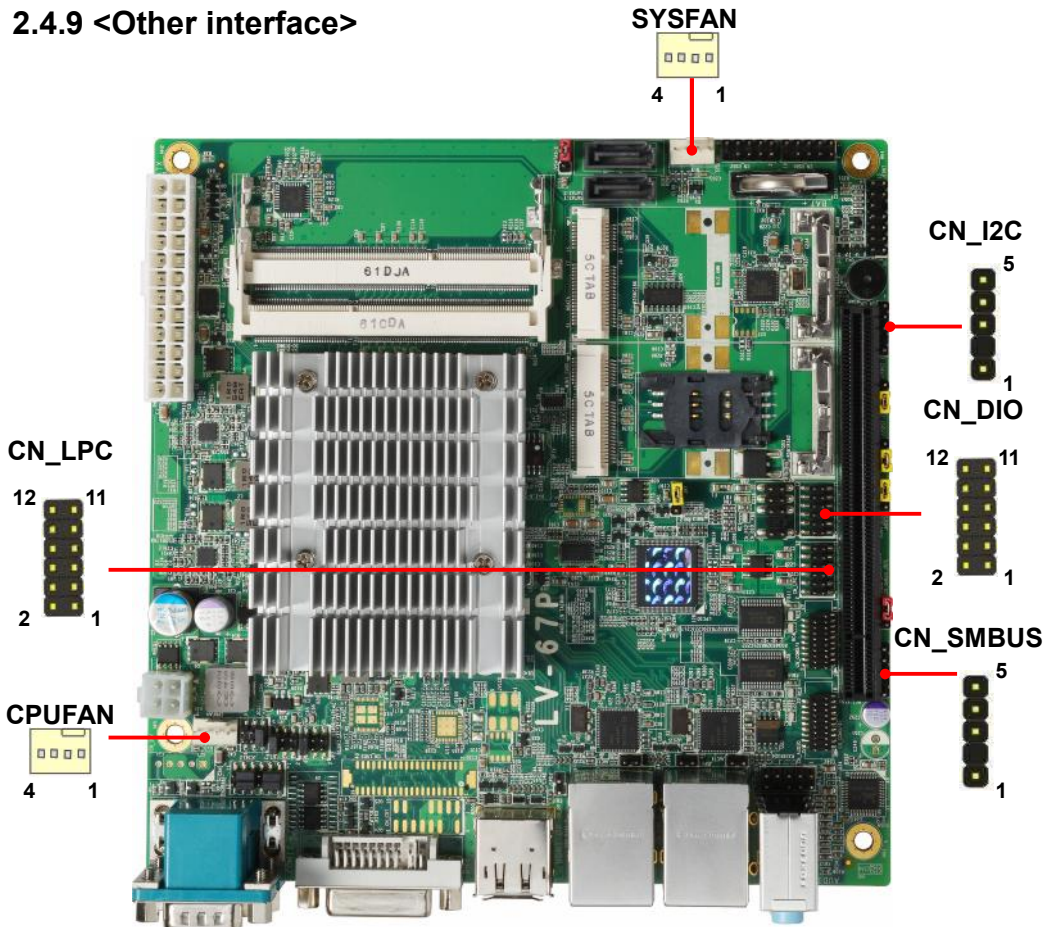

**CN\_LPC:** LPC 12-pin header (Pitch 2.00mm)

Pin	Signal	Pin	Signal
1	CLK	2	RST
3	-LFRAME	4	LAD3
5	LAD2	6	LAD1
7	LAD0	8	3.3V
9	SERIRQ	10	GND
11	3.3VSB	12	NC

**CN\_DIO:** GPIO 12-pin header (Pitch 2.00mm)

Pin	Signal	Pin	Signal
1	GND	2	GND
3	GPIO0	4	GPIO4
5	GPIO1	6	GPIO5
7	GPIO2	8	GPIO6
9	GPIO3	10	GPIO7
11	5V	12	12V

**CN\_SMBUS:** SMBus 5-pin connector

Pin	Signal
1	5V
2	NC
3	SMBDAT
4	SMBCLK
5	GND

**CN\_I2C:** I2C 5-pin connector

Pin	Signal
1	5V
2	NC
3	I2CDAT
4	I2CCLK
5	GND

**CPUFAN:** CPU cooler fan 4-pin connector

Pin	1	2	3	4
Signal	GND	12V	Sensor	Control

**SYSFAN:** System cooler fan 4-pin connector

Pin	1	2	3	4
Signal	GND	12V	Sensor	Control

## 2.5 <Power supply>

### 2.5.1 <Power input>

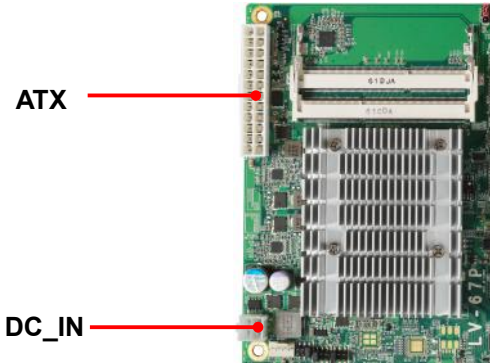

**DC\_IN:** Terminal Block 4-pin power connector

Pin	Signal	Pin	Signal
1	GND	2	Power in

The power support 9~24V wide voltage input.

**ATX:** main power 24-pin connector

Pin	Signal	Pin	Signal
1	3.3V	13	3.3V
2	3.3V	14	NC
3	GND	15	GND
4	5V	16	-PSON
5	GND	17	GND
6	5V	18	GND
7	GND	19	GND
8	Power_OK	20	NC
9	5VSB	21	5V
10	12V	22	5V
11	12V	23	5V
12	3.3V	24	GND

**DC\_IN and ATX can't use at the same time**

# Appendix A <Flash BIOS>

## A.1 BIOS Auto Flash Tool

The board is based on Phoenix BIOS and can be updated easily by the BIOS auto flash tool. You can download the tool online at the address below:

<http://www.phoenix.com>  
[LV-67P Reflash tool](#)

## A.2 Flash Method

1. Extract the zip file(re-flash tool and BIOS file) to root of the USB flash drive.
2. Insert your USB flash drive in USB port of the board and power on the system.
3. Boot to EFI-Shell mode (**UEFI Boot Enable, Legacy Boot Disable**)

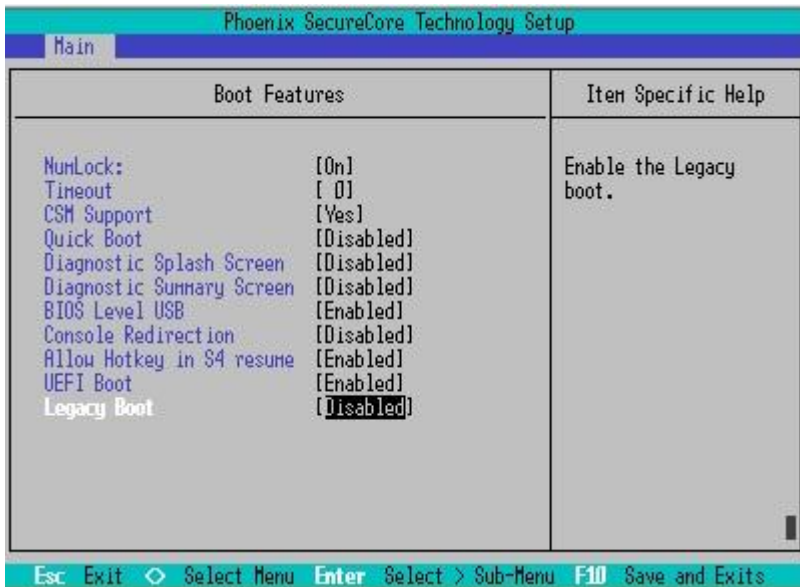

then input the “**fs0:**” command to switch to the root of the USB flash drive.

```
InitialDevice mapping tableAgent GE v1.4.02
fs0 :Renovable HardDisk - Alias hdZ310b blk0
      Acpi(PNPDR03,0)/Pci(1410)/Usb(8,0)/Hdt(Part1,Sig002B4588)
blk0 :Renovable HardDisk - Alias hdZ310b fs0
      Acpi(PNPDR03,0)/Pci(1410)/Usb(8,0)/Hdt(Part1,Sig002B4588)
blk1 :Renovable BlockDevice - Alias (null)
      Acpi(PNPDR03,0)/Pci(1410)/Usb(8,0)

Press ESC in 1 seconds to skip startup.nsh, any other key to continue.

Shell> fs0:
fs0:\> fpt64.efi -y -f xxxxx.bin
```

4. Type the “**fpt64.efi -y -f xxxxx.bin**” command to start flash BIOS processes. ( xxx.bin means the BIOS file that you want to update)

5. When it finished all update processes, restart the system.

Any question about the BIOS re-flash please contact your distributors or visit the web-site at below:

[http://www.commell.com.tw/contact/contact\\_info.htm](http://www.commell.com.tw/contact/contact_info.htm)



## Appendix B <LCD Panel Type select>

According your panel, it need to select the correct resolution in the BIOS. If there is no fit your panel type, please feedback for us to make OEM modul.

Find the setting from

Advanced-----> Uncore Configuration----->LCD Panel Type

BIOS panel type selection form (BIOS Version:1.0)			
Single / Dual channel		Single / Dual channel	
NO.	Type	NO.	Type
1	Auto	9	1366 x 768
2	640 x 480	10	1680 x 1050
3	800 x 600	11	1920 x 1200
4	1024 x 768	12	1400 x 900
5	1280 x 1024	13	1600 x 900
6	1400 x 1050 Reduced Blanking	14	1024 x 768
7	1400 x 1050 non-Reduced Blanking	15	1280 x 800
8	1600 x 1200	16	1920 x 1080
		17	OEM keep

## Appendix C <Programmable Watch Dog Timer>

### Timeout value range

1 to 255 Minute and Second

### Program sample

Watchdog timer setup as system reset with 5 second of timeout

```
-o 4E 87      ;enter configuration
-o 4E 87
-o 4E 07
-o 4F 08      ;select Logical Device
-o 4E 30
-o 4F 01      ; activate WDTO# function
-o 4E F5
-o 4F 00      ;set "00" is second mode, set "04" is minute mode
-o 4E F6
-o 4F 05      ;00h: Timeout Disable
                ;01h: Timeout occurs after 1 minute only
                ;02h: Timeout occurs after 2 second/minute
                ;03h: Timeout occurs after 3 second/minute
                ;
                ;
                ;FFh: Timeout occurs after 255 second/minute
                (The deviation is approx 1 second.)
```

For further information, please refer to Nuvoton NCT6106D datasheet

## Contact information

Any advice or comment about our products and service, or anything we can help you please don't hesitate to contact with us. We will do our best to support you for your products, projects and business.

### Taiwan Commate computer Inc.

<b>Address</b>	19F., NO.94, Sec. 1, Xintai 5 <sup>th</sup> Rd., Xizhi Dist., New Taipei City 22102, Taiwan.
<b>TEL</b>	+886-2-26963909
<b>FAX</b>	+886-2-26963911
<b>Website</b>	<a href="http://www.commell.com.tw">www.commell.com.tw</a>
<b>E-mail</b>	<a href="mailto:info@commell.com.tw">info@commell.com.tw</a> (General information) <a href="mailto:tech@commell.com.tw">tech@commell.com.tw</a> (Technical Support)

**Commell is a brand name of Taiwan Commate computer Inc.**