

LV-67S

Mini-ITX Desktop Motherboard

User's Manual

Edition 1.4
2016/03/23



Copyright

Copyright 2015, all rights reserved. This document is copyrighted and all rights are reserved. The information in this document is subject to change without prior notice to make improvements to the products.

This document contains proprietary information and protected by copyright. No part of this document may be reproduced, copied, or translated in any form or any means without prior written permission of the manufacturer.

All trademarks and/or registered trademarks contains in this document are property of their respective owners.

Disclaimer

The company shall not be liable for any incidental or consequential damages resulting from the performance or use of this product.

The company does not issue a warranty of any kind, express or implied, including without limitation implied warranties of merchantability or fitness for a particular purpose.

The company has the right to revise the manual or include changes in the specifications of the product described within it at any time without notice and without obligation to notify any person of such revision or changes.

Trademark

All trademarks are the property of their respective holders.

Any questions please visit our website at <http://www.commell.com.tw>

Packing List:

Please check the package content before you starting using the board.



1 x LV-67S Mini-ITX Motherboard



1 x VGA Cable
(OALVGN-S) / (1040568)

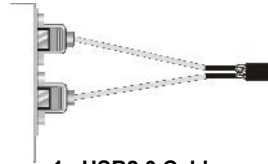

1 x USB2.0 Cable
(OALUSBA-1) / (1040172)



2 x SATA Cable
(OALSATA3-L) / (1040529)

OPTIONAL:

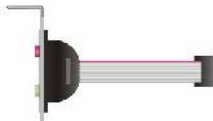

1 x Audio cable
(OALPJ-HDU) / (1040193)

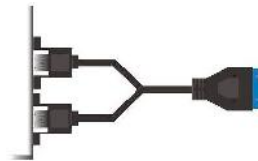

1 x USB3.0 Cable
(OALUSB3) / (1040531)



1 x Dual COM PORT Cable
(OALES-BKU2) / (1040087)

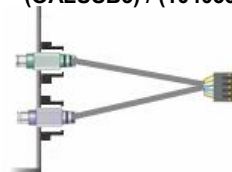

1 x PS/2 Keyboard & Mouse cable
(OALPS2/KMB) / (1040610)

Printed Matters:

Driver CD (Including User's Manual) x 1

Index

Chapter 1 <Introduction>	4
1.1 <Product Overview>	4
1.2 <Product Specification>	5
1.3 <Mechanical Drawing>	6
1.4 <Block Diagram>	7
Chapter 2 <Hardware setup>	8
2.1 <Connector Location and Reference>	8
2.1.1 <Internal connectors list>	9
2.1.2 <External connectors list>	9
2.2 <CPU and Memory Setup>	10
2.2.1 <CPU installation>	10
2.2.2 <Memory Setup>	11
2.3 <Jumper Location and Reference>	12
2.3.1 <Jumper list>	12
2.3.2 <Clear CMOS and Power on type selection>	13
2.4 <I/O interface>	13
2.4.1 <Serial ATA interface>	13
2.4.2 <Ethernet interface>	14
2.4.3 <Display interface>	14
2.4.4 <Serial Port interface>	17
2.4.5 <USB interface>	19
2.4.6 <Audio interface>	21
2.4.7 <Expansion slot>	22
2.4.8 <Front panel switch and indicator>	23
2.4.9 <GPIO and Other interface>	24
2.5 <Power supply>	26
2.5.1 <Power input>	26
Appendix A <Flash BIOS>	27
Appendix B <LCD Panel Type select>	27
Appendix C <Programmable Watch Dog Timer>	29
Contact information	31

Chapter 1 <Introduction>

1.1 <Product Overview>

LV-67S is Mini-ITX Motherboard which supports 6th Generation Intel® Core™ i7, i5, i3, S-series and Xeon® Processor with Intel® C236 Chipset, integrated HD Graphics 530, DDR4 memory, Realtek High Definition Audio, Intel Gigabit LAN, Serial ATA3

Intel Skylake-S Processor with Intel® C236 Chipset PCH-H

The 6th Generation Intel® Core™ S-series and Xeon® processor family is new generation and multi-core processor built on 14 nanometer process.

Skylake provide new HD Graphics 530 support triple displays at the same time, maximum supported is up to 32GB of DDR4, better performance, flexibility and more enhanced security that is suitable for a variety of intelligent systems the ideal choice.

All in One multimedia solution

LV-67S provides high performance onboard graphics, 18/24-bit single/dual channel LVDS interface, DisplayPort, DVI-I, CRT and High Definition Audio, to meet the requirement of the multimedia application.

Flexible Expansion Interface

It includes two minicard slot, PCIEX16 slot, 6 com port, 6 USB3.0, and 4 USB2.0.

Skylake remove EHCI

When you install WIN7 with USB device(CDROM, Keyboard, Mouse...), Windows7 can not identify your usb device. You can use SATA CD-ROM and PS/2 to install Windows7.

1.2 <Product Specification>

System

Processor	Intel® Skylake Core™ i7, i5, i3 S-series and Xeon® E3-1200 v5 Product Family Processor, FCLGA1151 package
Chipset	Intel® C236 PCH-H
Memory	2 x DDR4 DIMM 1866/2133 MHz up to 32GB, Support Non-ECC, unbuffered memory only
Watchdog Timer	Generates a system reset with internal timer for 1min/s ~ 255min/s
Real Time Clock	Chipset integrated RTC with onboard lithium battery
Expansion	1 x MiniPCle (support mSATA) 1 x Half Size MiniPCie (support mSATA) 1 x Sim slot 1 x PCIE X16 slot

Graphics

Chipset	Intel® 9th Gen integrated HD Graphics (Some Xeon® E3-1200 v5 Product don't have)
Display Interface	1 x DVI-I, 1 x DisplayPort(optional), 1 x LVDS, 1 x HDMI, 1 x CRT

LAN

Chip	1 x Intel® I219-LM Gigabit PHY LAN (Support iAMT11.0) 1 x Intel® I210-AT Gigabit LAN
------	--

I/O

Serial ATA	4 x SATA3
Audio	Realtek ALC262 HD Audio
Internal I/O	4 x SATA3, 4 x RS232, 4 x USB2.0, 2 x USB3.0, 1 x LVDS, 1 x LPC 1 x LCD inverter, 1 x GPIO , 1 x Audio, 1 x PS/2, 1 x SMBUS, 1 x CRT
Rear I/O	1 x DisplayPort(optional), 1 x DVI-I, 1 x HDMI, 4 x USB3.0, 2 x LAN, 1 x RS232/422/485, 1 x RS232, 1 x Audio.

Mechanical & Environmental

Power Requirement	Standard 24-pin ATX power supply and 4-pin 12V
Size & Thickness	170mm x 170mm (L x W)
Temperature	Operating within 0°C~60°C (32°F~140°F) Storage within -20°C~80°C (-4°F~176°F)
Relative Humidity	10%~90%, non-condensing

1.4 <Block Diagram>

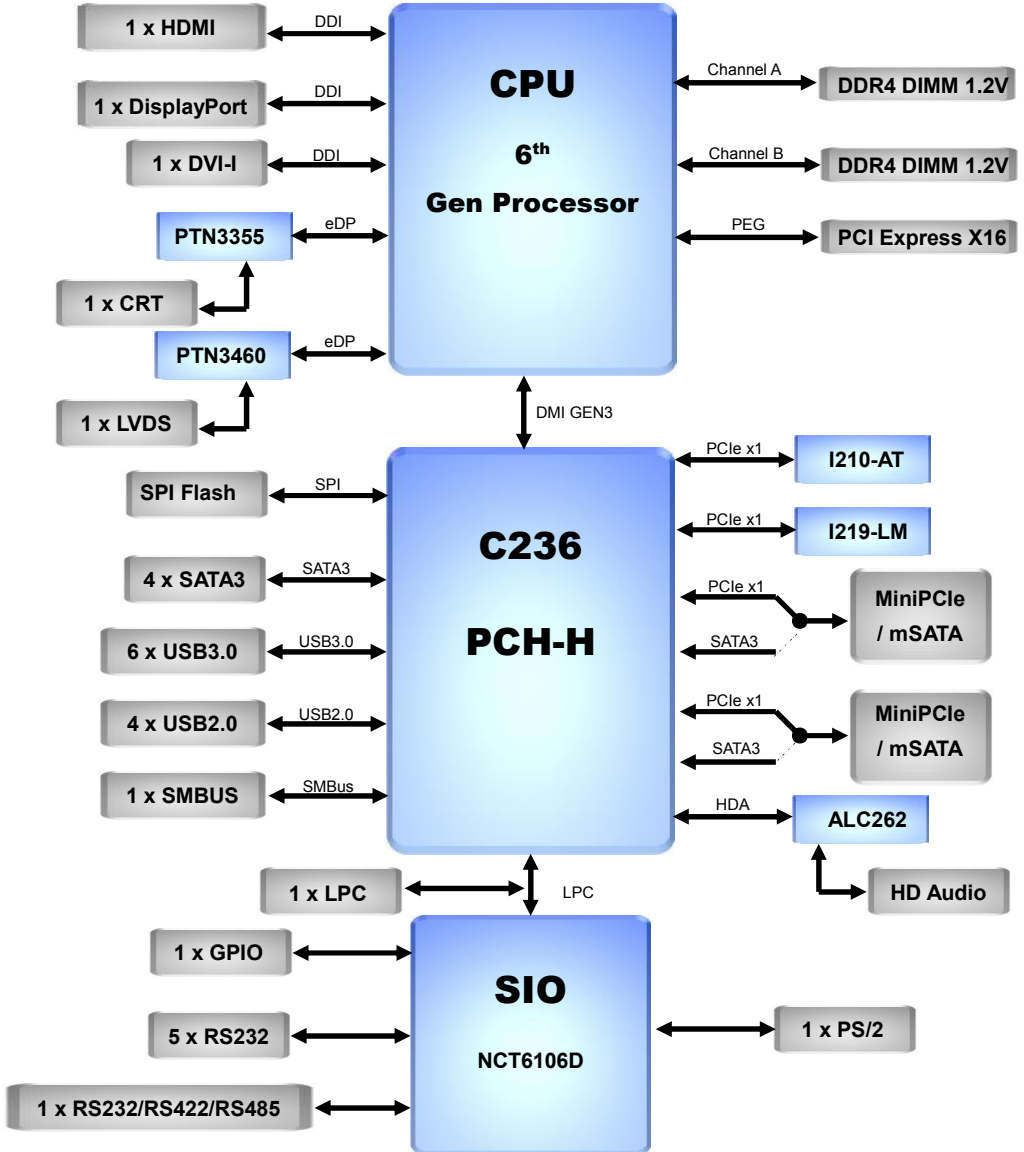

Chapter 2 <Hardware setup>

2.1 <Connector Location and Reference>

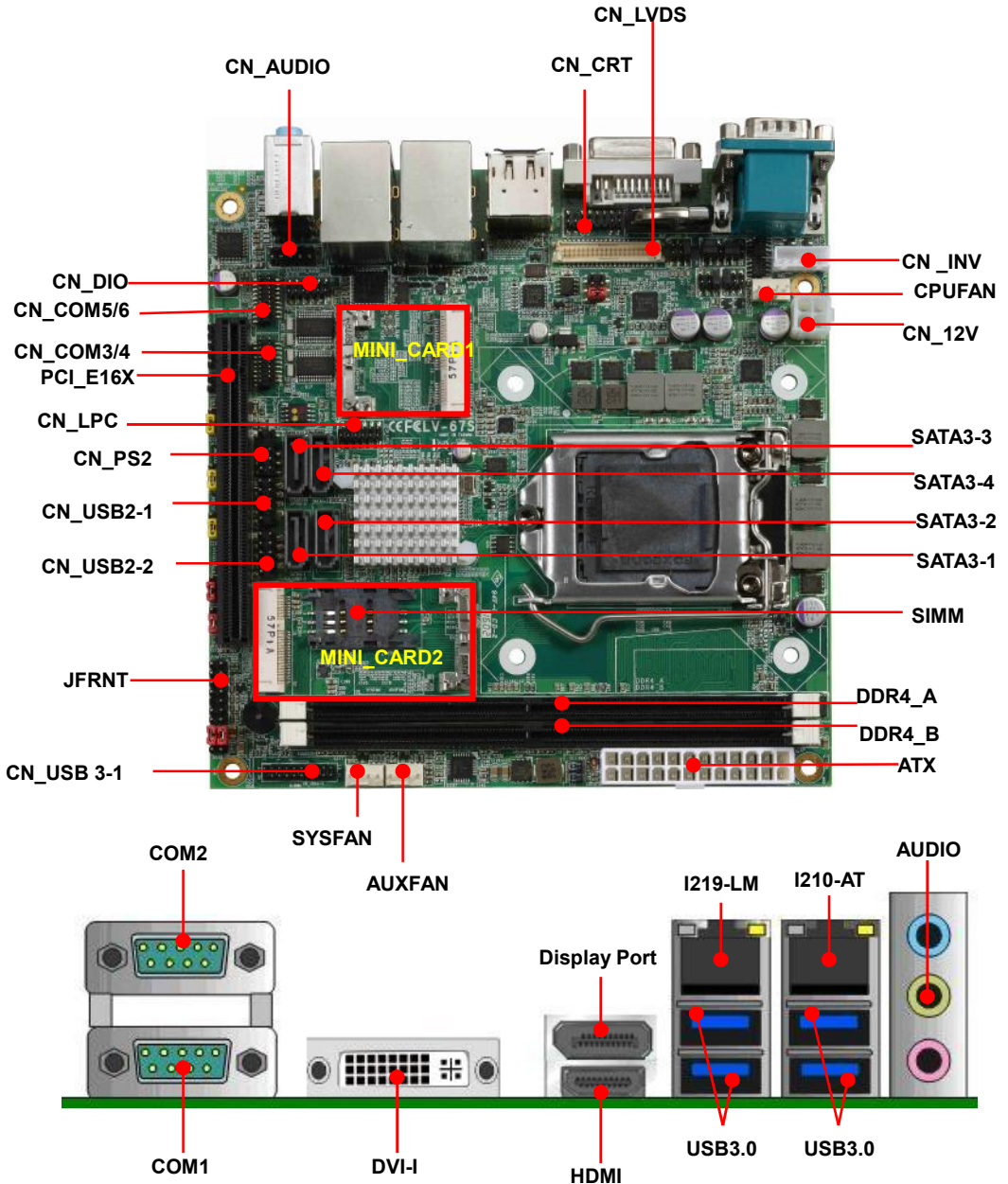

2.1.1 <Internal connectors list>

Connector	Function
DDR4_A/B	288-pin DDR4 DIMM slot
SATA3-1/2/3/4	7-pin Serial ATA3 connector
CN_AUDIO	5 x 2-pin audio pin header
CN_LPC	6 x 2-pin LPC pin header
CN_LVDS	20 x 2-pin LVDS connector
CN_INV	5-pin LCD inverter connector
CN_SMBUS	5-pin SMBus connector
CN_COM 3/4/5/6	20-pin RS232 connector
CN_USB 2-1/2-2	5 x 2-pin USB2.0 pin header
CN_USB 3-1	10 x 2-pin USB3.0 pin header
CN_PS2	5 x 2-pin PS/2 pin header
CN_DIO	6 x 2-pin digital I/O connector
CN_CRT	16-pin VGA connector
CPUFAN	4-pin CPU fan connector
SYSFAN	4-pin system fan connector
AUXFAN	4-pin system fan connector
JFRNT	14-pin front panel switch/indicator connector
PCI_E16X	164-pin x16 PCIE slot
MINI_CARD1	52-pin Half-MiniPCle card slot
MINI_CARD2	52-pin MiniPCle card slot
ATX	24-pin power supply connector
CN_12V	4-pin power input Terminal Block
SIMM	6-pin socket

2.1.2 <External connectors list>

Connector	Function
DisplayPort	DisplayPort connector
DVI-I	DVI connector
HDMI	HDMI connector
USB3.0	4 x USB3.0 connector
LAN	2 x RJ45 connector
AUDIO	Audio connector

2.2 <CPU and Memory Setup>

2.2.1 <CPU installation>

LV-67S has a LGA1151 CPU socket onboard; please check following steps to install the processor properly.

Attention If LV-67S need RMA please Keep CPU socket cover on the CPU Socket.

Warning If CPU Socket internal Pin damage We could not provide warranty.



Intel® Skylake Core™ i7, i5, i3 S-series and Xeon®
E3-1200 v5 Processor, FCLGA1151 package

1. Lift this bar

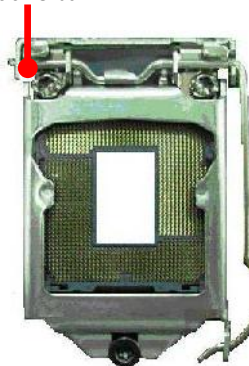

2. Uncover this plate

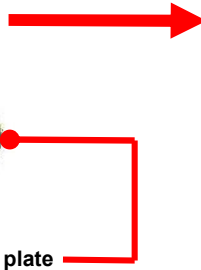

Checked point

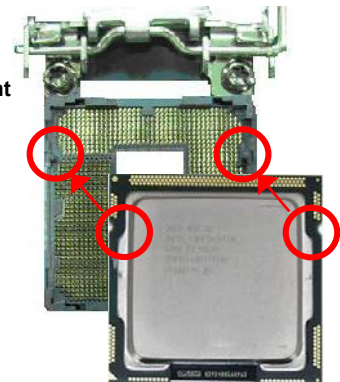

3. Place the CPU on the top of the pins

4. Cover this plate

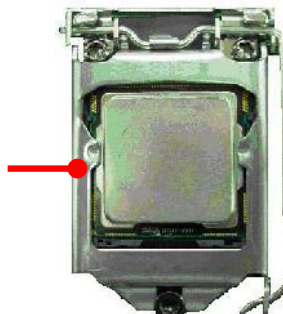

5. Lock this bar



2.2.2 <Memory Setup>

LV-67S has two 288-pin DDR4 DIMM support up to 32GB of memory capacity and 1.2 Voltage. The memory frequency supports 1866/2133 MHz. Only Non-ECC memory is supported.

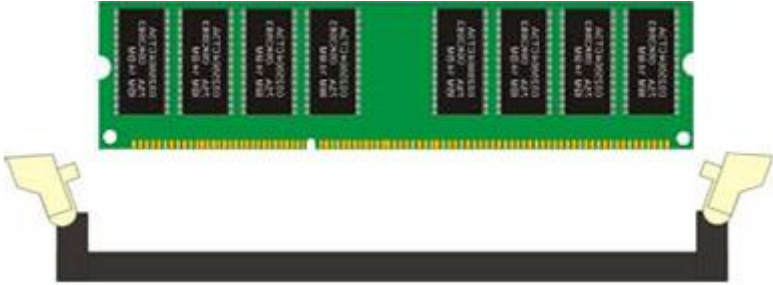

Please check the pin number to match the socket side well before installing memory module.

2.3 <Jumper Location and Reference>

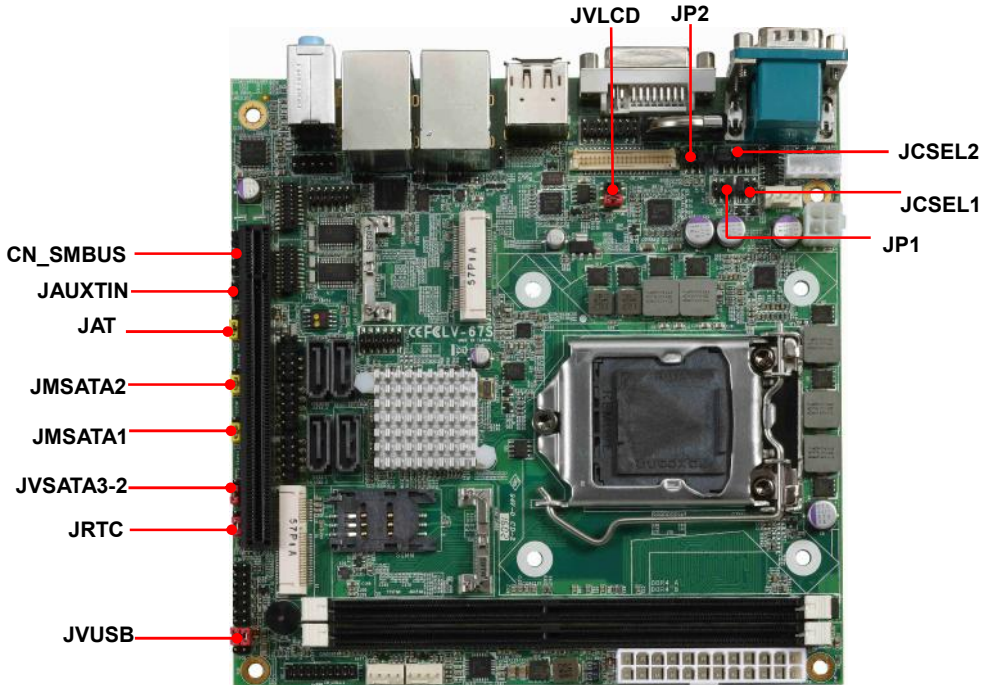

2.3.1 <Jumper list>

Jumper	Function
JAT	Power mode select
JRTC	CMOS Normal/Clear Setting
JVLCD	Panel Voltage Setting
JMSATA1	MiniCard 1 MSATA Setting
JMSATA2	MiniCard 2 MSATA Setting
JP1	COM1 Voltage Setting (For Pin 9)
JP2	COM2 Voltage Setting (For Pin 9)
JCSEL1	COM2 RS-232 RS422 RS485 Setting
JCSEL2	COM2 RS-232 RS422 RS485 Setting
JVSATA3-2	Set 5V to SATA3-2 pin 7 (For SATADOM)
JVUSB	USB Voltage Setting

2.3.2 <Clear CMOS and Power on type selection>

The board's data of CMOS can be setting in BIOS. If the board refuses to boot due to inappropriate CMOS settings, here is how to proceed to clear (reset) the CMOS to its default values.

JAT: AT/ATX mode select jumper

Jumper settings	Function
1-2	AT mode
2-3	ATX mode (Default)

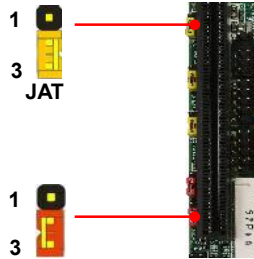

JRTC: Clear CMOS data jumper

Jumper settings	Function
1-2	Clear CMOS
2-3	Normal (Default)



2.4 <I/O interface>

2.4.1 <Serial ATA interface>

SATA 1/2/3/4: SATA3 7-pin connector

Pin	Signal
1	GND
2	TX+
3	TX-
4	GND
5	RX-
6	RX+
7	GND

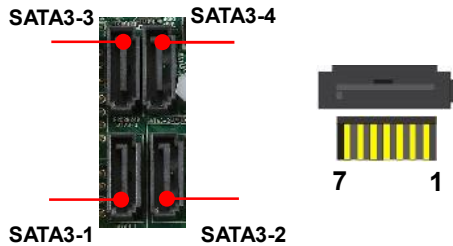

JVSATA3-2: SATA3/SATADOM mode select jumper (change pin7 to 5V)

Jumper settings	Function
1-2	SATA3-2 SATADOM
2-3	SATA3-2 SATA3 (Default)



2.4.2 <Ethernet interface>

The board provide I219-LM PHY Gigabit Ethernet and I210-AT Gigabit Ethernet on rear I/O. Intel I219-LM and I210 supports operation at 10/100/1000 Mb/s data rates, with IEEE802.3 compliance and Wake-On-LAN supported.

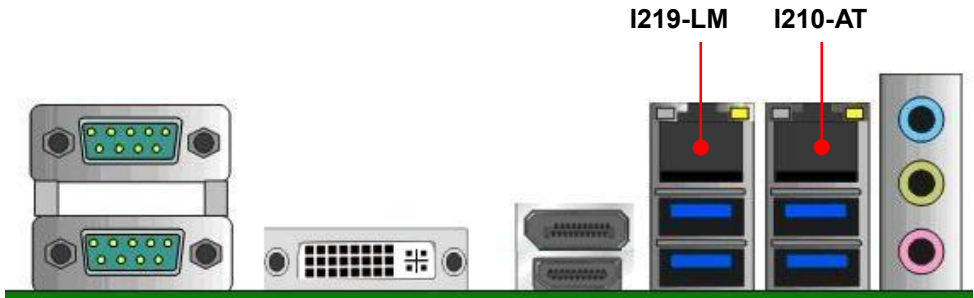

2.4.3 <Display interface>

Based on the 6th Gen CPU with built-in HD Graphics 530, CRT and DVI up to **1920x1080@60Hz**, DisplayPort up to **4096x2304@60Hz** , HDMI up to **4096x2304@24Hz** on rear IO. About the internal Display, LVDS (PTN3460) up to **1920x1200@60Hz** support 18/24-bit color depth and single/dual channel. About select LCD Panel Type in BIOS, please refer **Appendix B**.

The built-in HD Graphics support triple display function with clone mode and extended mode.

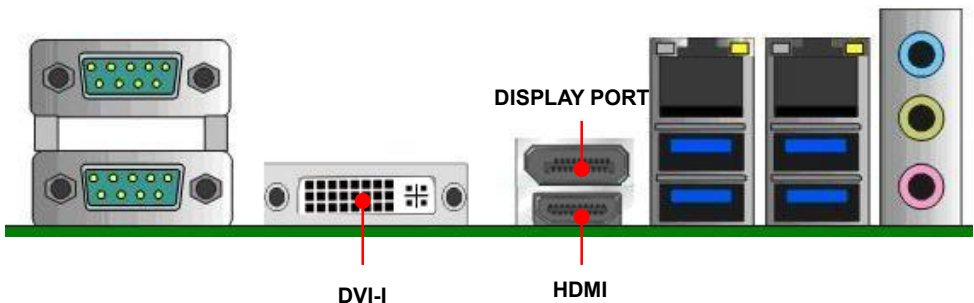

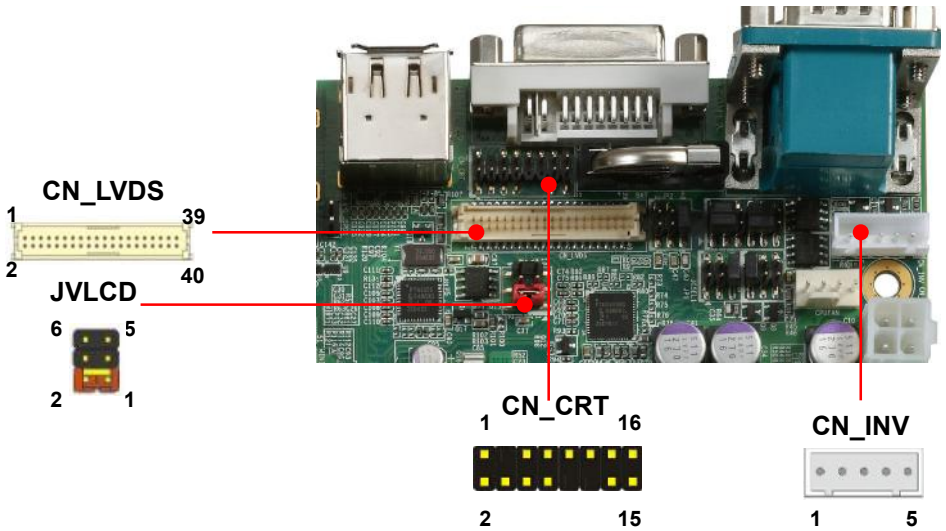
CN_CRT: CRT 16-pin connector (Pitch 2.00 mm)

Pin	Signal	Pin	Signal
1	BR	2	BG
3	BB	4	NC
5	-CRTATCH	6	IOGND1
7	IOGND1	8	IOGND1
9	NC	10	-CRTATCH
11	NC	12	5VCD A
13	5HSYNC	14	5VSYNC
15	5VCLK	16	NC

CN_LVDS: LVDS 40-pin connector (Model: HIROSE DF13-40DP-1.25V compatible)

Pin	Signal	Pin	Signal
2	Set by JVLCD	1	Set by JVLCD
4	Detect (Active low)	3	GND
6	A_LVDS_0-	5	B_LVDS_0-
8	A_LVDS_0+	7	B_LVDS_0+
10	GND	9	GND
12	A_LVDS_1-	11	B_LVDS_1-
14	A_LVDS_1+	13	B_LVDS_1+
16	GND	15	GND
18	A_LVDS_2-	17	B_LVDS_2-
20	A_LVDS_2+	19	B_LVDS_2+
22	GND	21	GND
24	A_LVDS_CLK-	23	B_LVDS_3-

26	A_LVDS_CLK+	25	B_LVDS_3+
28	GND	27	GND
30	A_LVDS_3-	29	B_LVDS_CLK-
32	A_LVDS_3+	31	B_LVDS_CLK+
34	GND	33	GND
36	LVDS_DDCSCL	35	NC
38	LVDS_DDCSDA	37	NC
40	NC	39	NC

Note: Pin4 only need to be connected to GND

CN_INV: LVDS 5-pin Backlight power connector

Pin	Signal
1	12V
2	Backlight Control
3	5V
4	GND
5	Enable Backlight

JVLCD: LVDS panel power select jumper

Jumper settings	Function
1-2	3.3V (Default)
2-3	5V
5-6	12V

2.4.4 <Serial Port interface>

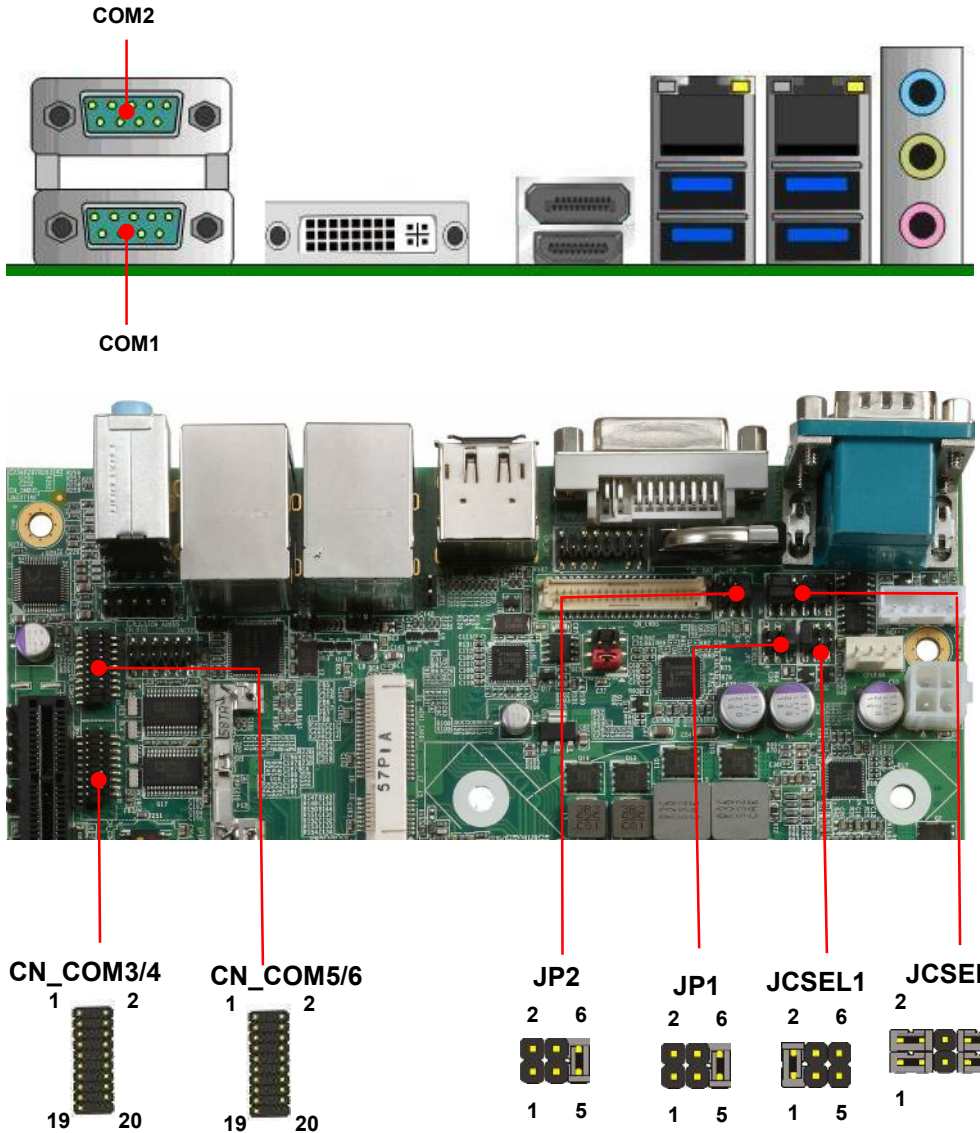

COM1: RS232 DB9 connector

Pin	Signal	Pin	Signal
1	DCD	2	RXD
3	TXD	4	DTR
5	GND	6	DSR
7	RTS	8	CTS
9	Set by JP1		

COM2: RS232/422/485 DB9 connector

Pin	Signal	Pin	Signal
1	DCD/ 422TX-/ 485-	2	RXD/ 422TX+/ 485+
3	TXD/ 422RX+	4	DTR/ 422RX-
5	GND	6	DSR
7	RTS	8	CTS
9	Set by JP2		

Use JCSEL1 and JCSEL2 to select communication mode

COM3/4: COM 20-pin header (Pitch 2.54 x 1.27mm)

Pin	Signal	Pin	Signal	
1	DCD1	2	RXD1	
3	TXD1	4	DTR1	
5	GND	6	DSR1	
7	RTS1	8	CTS1	
9	COM3 Set by JP3		10	NC
11	DCD2	12	RXD2	
13	TXD2	14	DTR2	
15	GND	16	DSR2	
17	RTS2	18	CTS2	
19	COM4 Set by JP4		20	Key

COM5/6: COM 20-pin header (Pitch 2.54 x 1.27mm)

Pin	Signal	Pin	Signal
1	DCD1	2	RXD1
3	TXD1	4	DTR1
5	GND	6	DSR1
7	RTS1	8	CTS1
9	RI1	10	NC
11	DCD2	12	RXD2
13	TXD2	14	DTR2
15	GND	16	DSR2

17	RTS2	18	CTS2
19	RI2	20	Key

JP1, JP2: COM1, COM2 pin-9 setting

Jumper settings	Function
1-2	5V
3-4	12V
5-6	RI (Default)

Effective patterns of connection: 1-2 / 3-4 / 5-6

Other may cause damage

JCSEL1, JCSEL2: For configure COM2 communication mode

Function	JCSEL1	JCSEL2
RS232	<p>2 6 1 5</p>	<p>2 12 1 11</p>
RS485	<p>2 6 1 5</p>	<p>2 12 1 11</p>
RS422	<p>2 6 1 5</p>	<p>2 12 1 11</p>

2.4.5 <USB interface>

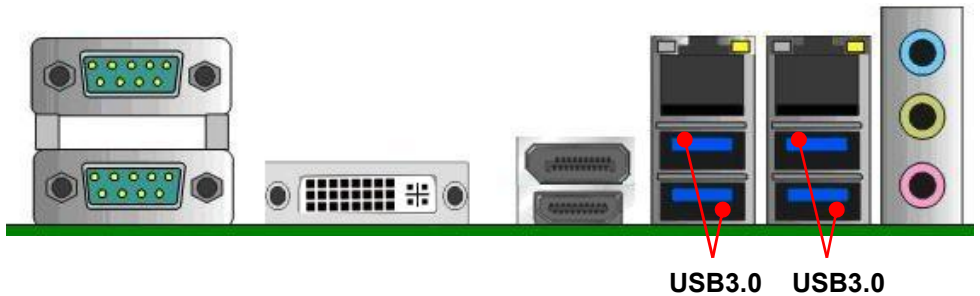

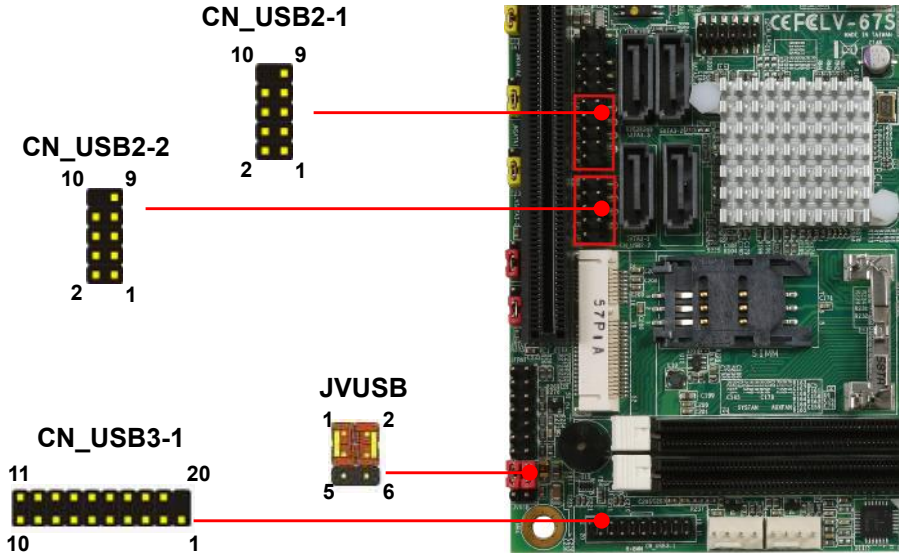
CN_USB 2-1/2-2: USB2.0 10-pin header (Pitch 2.54 mm)

Pin	Signal	Pin	Signal
1	5VSB	2	5VSB
3	DATA0-	4	DATA1-
5	DATA0+	6	DATA1+
7	GND	8	GND
9	GND	10	Key

CN_USB3-1: USB3.0 20-pin header (Pitch 2.00 mm)

Pin	Description	Pin	Description
1	VCC (5V_SB/ 5V)	20	NC
2	USB3.0_RX0-	19	VCC (5V_SB/ 5V)
3	USB3.0_RX0+	18	USB3.0_RX1-
4	Ground	17	USB3.0_RX1+
5	USB3.0_TX0-	16	Ground
6	USB3.0_TX0+	15	USB3.0_TX1-
7	Ground	14	USB3.0_TX1+
8	Data0-	13	Ground
9	Data0+	12	Data1-
10	NC	11	Data1+

JVUSB: 6-pin Power select jumper

Pin	Description
1-3 & 2-4	5V_SB
3-5 & 4-6	5V

Default: 1-3 & 2-4

Effective patterns of connection: 1-3 & 2-4 or 3-5 & 4-6

2.4.6 <Audio interface>

Rear Audio Jack



Line in

Line out

Mic in

CN_AUDIO

2 10



1 9

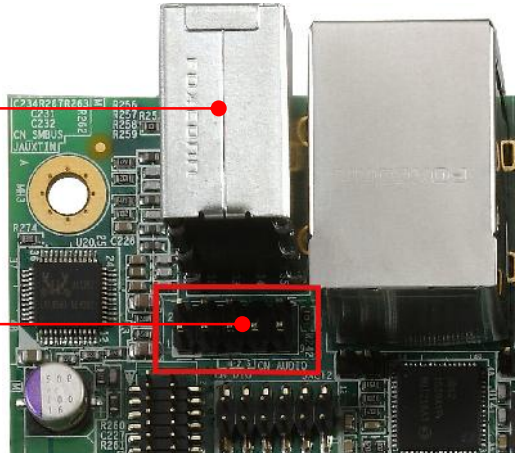

CN_AUDIO: Front panel audio 10-pin header (Pitch 2.54mm)

Pin	Signal	Pin	Signal
1	MIC_L	2	GND
3	MIC_R	4	NC
5	FP_OUT_R	6	MIC_DETECT
7	SENSE	8	Key
9	FP_OUT_L	10	FP_OUT_DETECT

2.4.7 <Expansion slot>

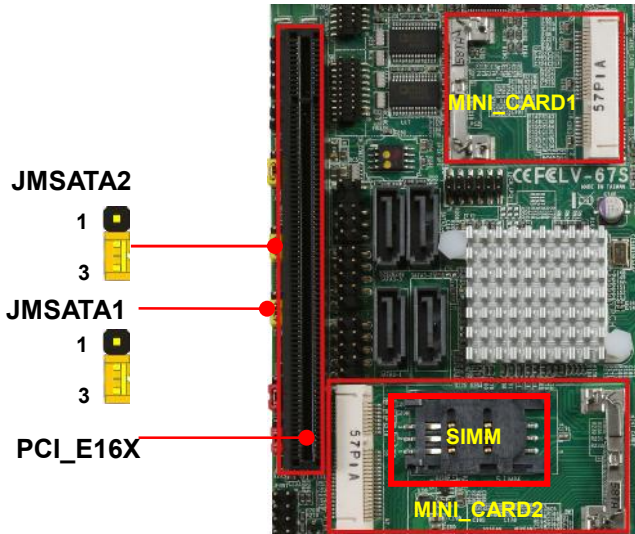

MINI_CARD1 and MINI_CARD2 have some special design to compatible our mini-PCIe card. (ex: MPX-574D2, MPX-210D2 etc)

MINI_CARD1 support mSATA by JMSATA1

MINI_CARD2 support mSATA by JMSATA2, and connect SIM card with 3G module.

JMSATA1/2: Setting MINI_CARD to support PCIe/mSATA

Jumper settings	Function
1-2	Support mSATA
2-3	Normal operation (Default)

2.4.8 <Front panel switch and indicator>

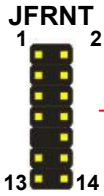

JFRNT: Front panel switch and indicator 14-pin header (Pitch 2.54mm)

Pin	Signal	Pin	Signal
1	HDD_LED+	2	Power_LED+
3	HDD_LED-	4	NC
5	Reset+	6	Power_LED-
7	Reset-	8	Speaker+
9	Key	10	NC
11	Power_ON+	12	NC
13	Power_ON-	14	Speaker-

2.4.9 <GPIO and Other interface>

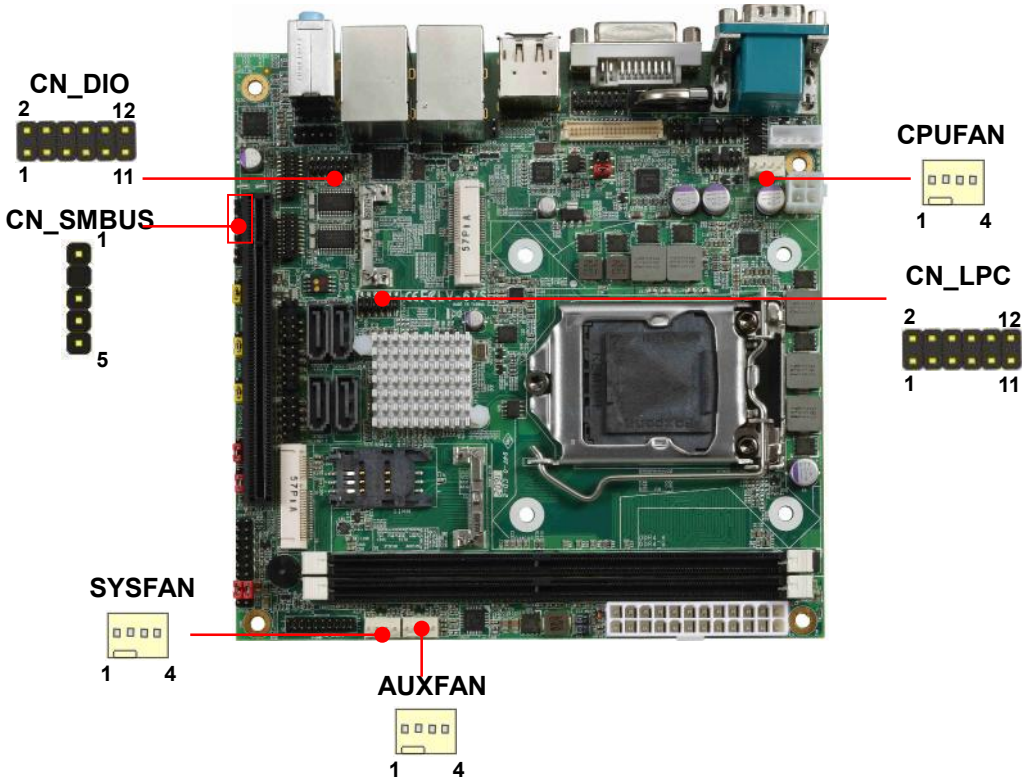

When using GPIO function, please note:

As Output: **Open-drain**, most applications **need use an external pull up resistor. (If not may cause damage)**

As Input: **TTL-level**.

GPIO DC characteristics

Parameter	SYM	MIN	TYP	MAX	UNIT	Conditions
Input Low Voltage	V_{IL}			0.8	V	
Input High Voltage	V_{IH}	2.0			V	
Output Low Voltage	V_{OL}			0.4	V	$I_{OL} = 12\text{mA}$
Input High Leakage	I_{LH}			+10	μA	$V_{IN} = 3.3\text{V}$
Input Low Leakage	I_{LL}			-10	μA	$V_{IN} = 0\text{V}$

CN_DIO: GPIO 12-pin header (Pitch 2.00mm)

Pin	Signal	Pin	Signal
1	GND	2	GND
3	GPIO0	4	GPIO4
5	GPIO1	6	GPIO5
7	GPIO2	8	GPIO6
9	GPIO3	10	GPIO7
11	5V	12	12V

CN_LPC: LPC 12-pin header (Pitch 2.00mm)

Pin	Signal	Pin	Signal
1	CLK	2	RST
3	-LFRAME	4	LAD3
5	LAD2	6	LAD1
7	LAD0	8	3.3V
9	SERIRQ	10	GND
11	3.3VSB	12	NC

CN_SMBUS: SMBus 5-pin connector (Pitch 2.54mm)

Pin	Signal
1	5V
2	NC
3	SMBDAT
4	SMBCLK
5	GND

CPUFAN: CPU cooler fan 4-pin connector

Pin	1	2	3	4
Signal	GND	12V	Sensor	Control

SYSFAN: System cooler fan 4-pin connector

Pin	1	2	3	4
Signal	GND	12V	Sensor	Control

AUXFAN: AUX cooler fan 4-pin connector

Pin	1	2	3	4
Signal	GND	12V	Sensor	Control

2.5 <Power supply>

2.5.1 <Power input>

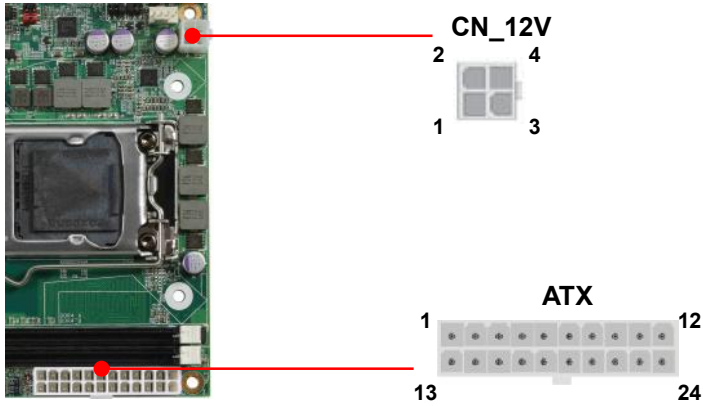

CN_12V: ATX12V 4-pin connector

Pin	Signal	Pin	Signal
1	GND	2	GND
3	12V	4	12V

ATX: main power 24-pin connector (As input)

Pin	Signal	Pin	Signal
1	3.3V	13	3.3V
2	3.3V	14	NC
3	GND	15	GND
4	5V	16	-PSON
5	GND	17	GND
6	5V	18	GND
7	GND	19	GND
8	Power_OK	20	NC
9	5VSB	21	5V
10	12V	22	5V
11	12V	23	5V
12	3.3V	24	GND

Appendix A <Flash BIOS>

A.1 <Flash tool>

The board is based on Phoenix BIOS and can be updated easily by the BIOS auto flash tool. You can download the tool online at the address below:

[FPT TOOL](#)

The tool's file name is "fpt.exe", it's the utility that can write the data into the BIOS flash chip and update the BIOS.

A.2 <Flash BIOS process>

1. Please make a bootable UFD which can boot into DOS environment.
2. Unzip the flash tool and copy it into bootable UFD.
3. Add a bin file to the same folder..
4. Power on the system and flash the BIOS under the DOS environment.

(Command: fpt -savemac -f xxx.bin)

5. Power off the system and then power on.

Appendix B <LCD Panel Type select>

According your panel, it need to select the correct resolution in the BIOS. If there is no fit your panel type, please feedback for us to make OEM model.

You can find the setting from

Advanced→Intel Advanced Menu

SA configuration→Graphics configuration→LCD control→LCD Panel Type

Phoenix SecureCore Technology Setup	
Advanced	
Intel Advanced Menu	Item Specific Help
PCI Subsystem Settings ACPI Settings CPU Configuration Power & Performance System Agent (SA) Configuration PCH-I/O Configuration Manageability Application Configuration Super I/O Chip	System Agent (SA) Parameters
F1 Help Esc Exit <> Select Menu +/- Select Item Enter Change Values Select Sub-Menu	F9 Setup Defaults F10 Save and Exit

Phoenix SecureCore Technology Setup	
Advanced	
Graphics Configuration	Item Specific Help
Internal Graphics [Auto] GTT Size [8MB] Aperture Size [256MB] DUMT Pre-Allocated [32M] DUMT Total Gfx Mem [256M] Gfx Low Power Mode [Enabled] UDD Enable [Enabled] HDCP Support [Enabled] Algorithm [One-time] PM Support [Enabled] PAUP Enable [Enabled] Cd Clock Frequency [675 Mhz] IUER Button Enable [Disabled] LCD Control Intel(R) Ultrabook Event Support	LCD Control
F1 Help Esc Exit <> Select Menu +/- Select Item Enter Change Values Select Sub-Menu	F9 Setup Defaults F10 Save and Exit

BIOS panel type selection form (BIOS Version:1.0)			
Single / Dual channel		Single / Dual channel	
NO.	Type	NO.	Type
1	VBIOS DEFAULT	9	1366 x 768
2	640 x 480	10	1680 x 1050
3	800 x 600	11	1920 x 1200
4	1024 x 768	12	1400 x 900
5	1280 x 1024	13	1600 x 900
6	1400 x 1050 Reduced Blanking	14	1024 x 768
7	1400 x 1050 non-Reduced Blanking	15	1280 x 800
8	1600 x 1200	16	1920 x 1080
		17	OEM

Appendix C <Programmable Watch Dog Timer>

The watchdog timer makes the system auto-reset while it stops to work for a period. The integrated watchdog timer can be setup as system reset mode by program. You can select Timer setting in the BIOS, after setting the time options, the system will reset according to the period of your selection.

Find the setting from

Advanced → Intel Advanced Menu → Super IO Chip

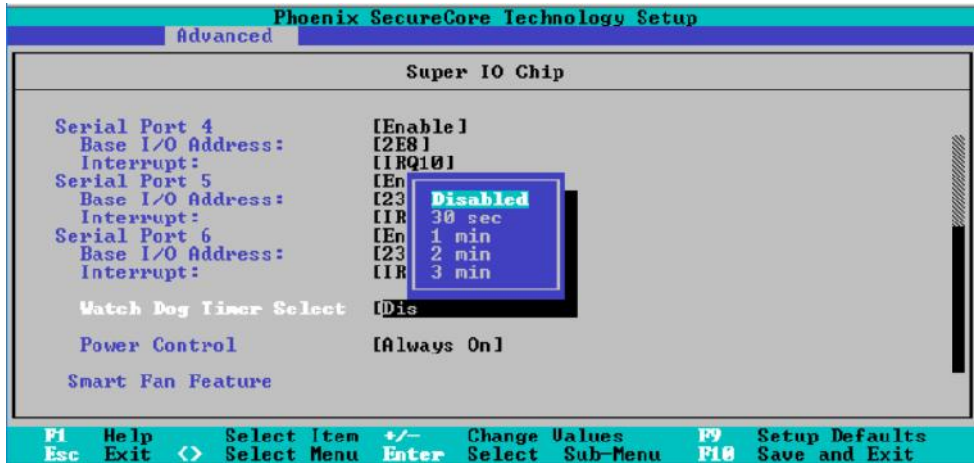

Timeout value range

1 to 255 Minute and Second

Program sample

Watchdog timer setup as system reset with 5 second of timeout

- o 4E 87 ;enter configuration
- o 4E 87
- o 4E 07
- o 4F 08 ;select Logical Device
- o 4E 30

- o 4F 01 ; activate WDTO# function
- o 4E F5
- o 4F 00 ;set "00" is second mode, set "04" is minute mode
- o 4E F6
- o 4F 05 ;00h: Timeout Disable
;01h: Timeout occurs after 1 minute only
;02h: Timeout occurs after 2 second/minute
;03h: Timeout occurs after 3 second/minute
:
;FFh: Timeout occurs after 255 second/minute
(The deviation is approx 1 second.)

For further information, please refer to Nuvoton NCT6106D datasheet

Contact information

Any advice or comment about our products and service, or anything we can help you please don't hesitate to contact with us. We will do our best to support you for your products, projects and business.

Taiwan Commate computer Inc.

Address	19F., NO.94, Sec. 1, Xintai 5 th Rd., Xizhi Dist., New Taipei City 22102, Taiwan.
TEL	+886-2-26963909
FAX	+886-2-26963911
Website	www.commell.com.tw
E-mail	info@commell.com.tw (General information) tech@commell.com.tw (Technical Support)

Commell is a brand name of Taiwan Commate computer Inc.