

ET-2200 Series Ethernet I/O Modules User Manual



Ethernet I/O Module

Ver. 1.1.3 Feb. 2016

WARRANTY

All products manufactured by ICP DAS are warranted against defective materials for a period of one year from the date of delivery to the original purchaser.

WARNING

ICP DAS assumes no liability for damages consequent to the use of this product. ICP DAS reserves the right to change this manual at any time without notice. The information furnished by ICP DAS is believed to be accurate and reliable. However, no responsibility is assumed by ICP DAS for its use, nor for any infringements of patents or other rights of third parties resulting from its use.

COPYRIGHT

Copyright © 2016 by ICP DAS. All rights are reserved.

TRADEMARK

Names are used for identification only and may be registered trademarks of their respective companies.

CONTACT Us

If you have any questions, please feel free to contact us via email at:

service@icpdas.com, service.icpdas@gmail.com



SUPPORT

This manual relates to the following modules:

ET-2242, ET-2251, ET-2254, ET-2254P,
ET-2255 , ET-2260, ET-2261 and
ET-2268

TABLE OF CONTENTS

1.	INTRODUCTION	5
1.1	FEATURES.....	5
2.	HARDWARE INFORMATION	9
2.1	APPEARANCE	9
2.2	SPECIFICATION	11
	2.2.1 System Specification	11
	2.2.2 I/O Specification	12
	2.2.2.1 ET-2242	12
	2.2.2.2 ET-2251	12
	2.2.2.3 ET-2254/2254P	13
	2.2.2.4 ET-2255	14
	2.2.2.5 ET-2260	15
	2.2.2.6 ET-2261	16
	2.2.2.7 ET-2268	17
2.3	PIN ASSIGNMENTS	18
	2.3.1 ET-2242	18
	2.3.2 ET-2251	18
	2.3.3 ET-2254/2254P.....	19
	2.3.4 ET-2255	19
	2.3.5 ET-2260	20
	2.3.6 ET-2261	20
	2.3.7 ET-2268	21
2.4	WIRING CONNECTIONS	22
	2.4.1 Input Wiring	22
	2.4.2 Output Wiring.....	23
2.5	WIRING TO THE CONNECTOR.....	25
2.6	DIMENSIONS.....	26
3.	GETTING STARTED	27
3.1	CONFIGURING THE BOOT MODE	27
3.2	CONNECTING THE POWER AND THE HOST PC.....	28
3.3	CONFIGURING THE NETWORK SETTINGS	29
3.4	MODBUS TCP TESTING.....	31
4.	WEB CONFIGURATION	33

- 4.1 LOGGING IN TO THE WEB SERVER 33
- 4.2 HOME 35
- 4.3 NETWORK 36
 - 4.3.1 IP Address Configuration 36
 - 4.3.1.1 Dynamic Configuration38
 - 4.3.1.2 Manual Configuration38
 - 4.3.2 General Settings 39
 - 4.3.3 Restore Factory Defaults 40
 - 4.3.4 Firmware Update..... 42
- 4.4 I/O SETTINGS 43
 - 4.4.1 DO Control 43
 - 4.4.2 DI/DO Configuration..... 44
- 4.5 SYNC 47
 - 4.5.1 DIO Synchronization 47
- 4.6 PWM 49
 - 4.6.1 PWM Configuration..... 49
- 4.7 PAIR CONNECTION 51
 - 4.7.1 I/O Pair-Connection Settings 51
- 4.8 FILTER 54
 - 4.8.1 Filter Settings..... 54
- 4.9 MONITOR 56
- 4.10 CHANGE PASSWORD..... 57
- 4.11 LOGOUT..... 58
- 5. I/O PAIR CONNECTION APPLICATIONS 59**
 - 5.1 ONE MODULE POLLING THE REMOTE DI/DO (1-TO-1, POLLING MODE) 59
 - 5.1.1 Polling Mode..... 61
 - 5.1.2 Push Mode..... 62
 - 5.2 TWO MODULES PUSHING THE LOCAL DI TO EACH OTHER (1-TO-1, PUSH MODE) 63
 - 5.3 SEVERAL MODULES POLLING THE REMOTE DI (M-TO-1) (POLLING MODE) 66
 - 5.4 SEVERAL MODULES PUSHING THE LOCAL DI (M-TO-1) (PUSH MODE) 69
- 6. MODBUS INFORMATION 72**
 - 6.1 WHAT IS MODBUS TCP/IP? 72
 - 6.2 MODBUS MESSAGE STRUCTURE 73
 - 6.2.1 01(0x01) Read the Status of the Coils (Readback DOs) 76
 - 6.2.2 02(0x02) Read the Status of the Input (Read DIs) 78
 - 6.2.3 03(0x03) Read the Holding Registers (Readback AOs) 80
 - 6.2.4 04(0x04) Read the Input Registers (Read AIs) 82

6.2.5 05(0x05) Force a Single Coil (Write DO) 84

6.2.6 06(0x06) Preset a Single Register (Write AO) 86

6.2.7 15(0x0F) Force Multiple Coils (Write DOs)..... 88

6.2.8 16(0x10) Preset Multiple Registers (Write AOs) 90

6.3 MODBUS REGISTER TABLE 92

6.3.1 Common Functions..... 92

6.3.2 Specific Functions 94

1. Introduction

The ET-2200 series modules, a IP-based Ethernet I/O module, features a built-in web server which allows configuration, I/O monitoring and I/O control by simply using a regular web browser. In addition, the ET-2200 also supports Modbus TCP/UDP protocol that makes perfect integration to SCADA software.

1.1 Features

1. Built-in Web Server

The ET-2200 series module has a built-in web server that allows users to easily configure, monitor and control the module from a remote location using a web browser.

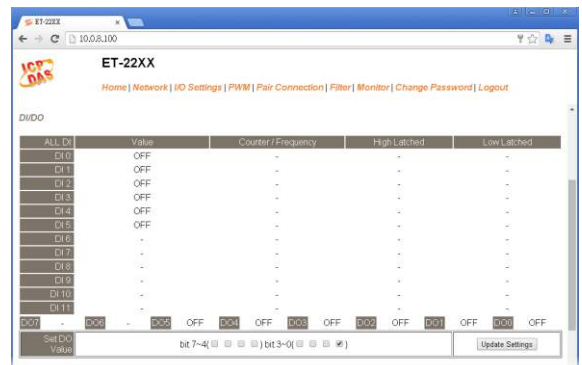

2. Support Modbus TCP/UDP Protocols

The Modbus TCP, Modbus UDP slave function on the Ethernet port can be used to provide data to remote SCADA software.

3. I/O Pair Connection (Push and Polling)

This function is used to create a DI to DO pair through the Ethernet. Once the configuration is completed, ET-2200 module can continuously poll the status of remote DI device using the Modbus TCP protocol and then write to local DO channels in the background.

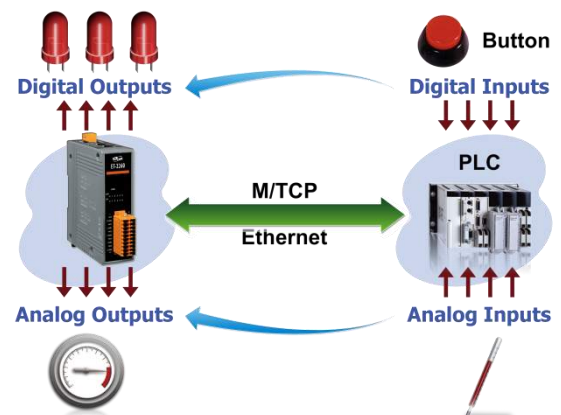

4. Built-in Multi-function I/O

- All **Digital Output** modules provide:
 - A **Power-on Value** (On boot up, the digital output value is set as the Power-on value)
 - A **Safe Value** (If Modbus TCP communication is lost for a certain period, the digital output value will be set as the user-defined safe value)
 - A **PWM Function**: The digital output channels support PWM (pulse generation) function that can be configured with different frequency (100 Hz Max.) and different duty cycle for each channel. The term “High Duty Cycle” describes the duration of 'on' time in proportion to the regular interval or 'period' of time. Similarly, the term “Low Duty Cycle” corresponds to the duration of the 'off' time. Consequently, it is not necessary to keep switching from ON to OFF from a remote controller. In this way, the ET-2200 series module reduces the complexity required for the control system and enhances timing accuracy.  **Note: Because of the characteristics of the relay functions, it is recommended that the PWM on modules with relay functions is not used for extended periods of time.**

- All **Digital Input** modules provide:
 - **Digital input channels that can also be used as 32-bit high speed (3 kHz) counters.**
 - **High/Low Latched Status Commands**: The modules provide commands to read the status of any digital input channels that are latched high or latched low. The following is an example that shows the usefulness of the latched digital input. If we wish to read a key stroke from a key switch connected to the digital input channel of a module, the input signal of the key stroke is a pulse signal as shown in the figure.

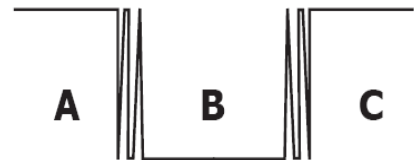

If we just use the read digital input status command to read the signal and we cannot send the command during the B period due to some reasons, then we will lose the key stroke information. However, with the read latched digital input command, we can still get the key stroke information even we are not able to send command in B period.

- **Frequency Measurement**: ET-2200 series modules also provide a frequency measurement function that retrieves the digital input counter value at specific times and calculates the frequency. Rather than polling via a remote host, the ET-2200 series modules can determine the frequency directly, reducing the communication delay caused by two ends and also improves the accuracy of the frequency measurement. In order to applying for more applications, this module provides 3 scan modes and 4 moving average methods for user to select the best way in their applications.

- **DIO Synchronization (Mirror Local DI to DO):** ET-2200 series modules also provide a DIO synchronization function. The DIO synchronization is divided into three modes: **Level Sync**, **Rising Active** and **Falling Active**.

- **Level Sync (DO = DI) Mode:** The synchronization operation in DI and DO.

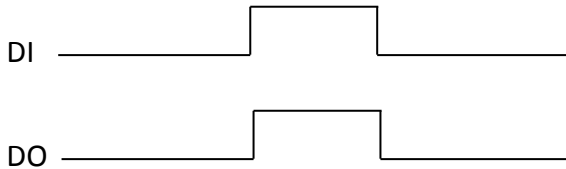

- **Rising Active (DO = ON) Mode:** When the specified DI state from OFF to ON, the corresponding DO will be set to ON.

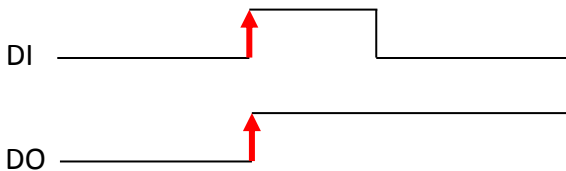

- **Falling Active (DO = ON) Mode:** When the specified DI state from ON to OFF, the corresponding DO will be set to ON.

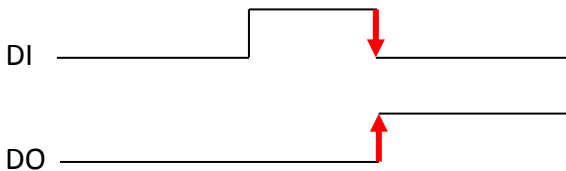

5. Built-in Dual Watchdog

The Dual Watchdog consists of a CPU Watchdog (for hardware functions) and a Host Watchdog (for software functions).

- **CPU Watchdog** automatically resets it-self when the built-in firmware runs abnormally.
- **Host Watchdog** set the digital output with predefined safe-value when there is no communication between the module and host (PC or PLC) over a period of time (Watchdog timeout).



6. Daisy-chain Ethernet Cabling

The ET-2200 has a built-in two-port Ethernet switch to implement daisy-chain topology. The cabling is much easier and total costs of cable and switch are significantly reduced.

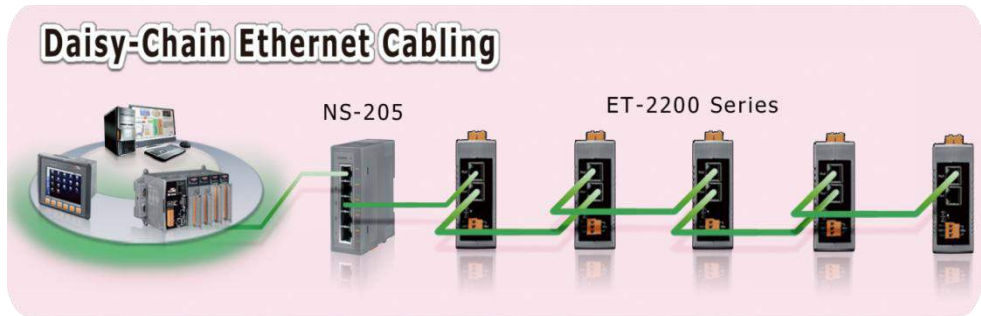

7. LAN Bypass

LAN Bypass feature guarantees the Ethernet communication. It will automatically active to continue the network traffic when the ET-2200 loses its power.

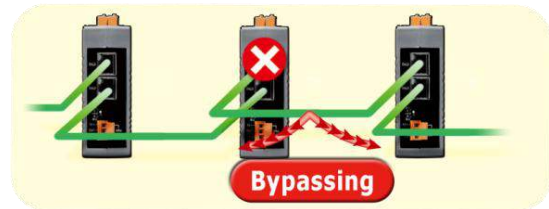

8. Slim-Type Housing

The ET-2200 modules are slim-type housing with about 3.3 cm in width. Compared with the palm-size module that has about 7 cm in width, more slim-type ET-2200 modules can be installed on the same DIN-Rail space.



9. Highly Reliable Under Harsh Environment

- Wide Operating Temperature Range: -25 ~ +75°C
- Storage Temperature: -30 ~ +80°C
- Humidity 10 ~ 90% RH (Non-condensing)



2. Hardware Information

2.1 Appearance

The front panel and top panel of the ET-2200 module contain the I/O connector, LEDs, Ethernet Port and power connector.

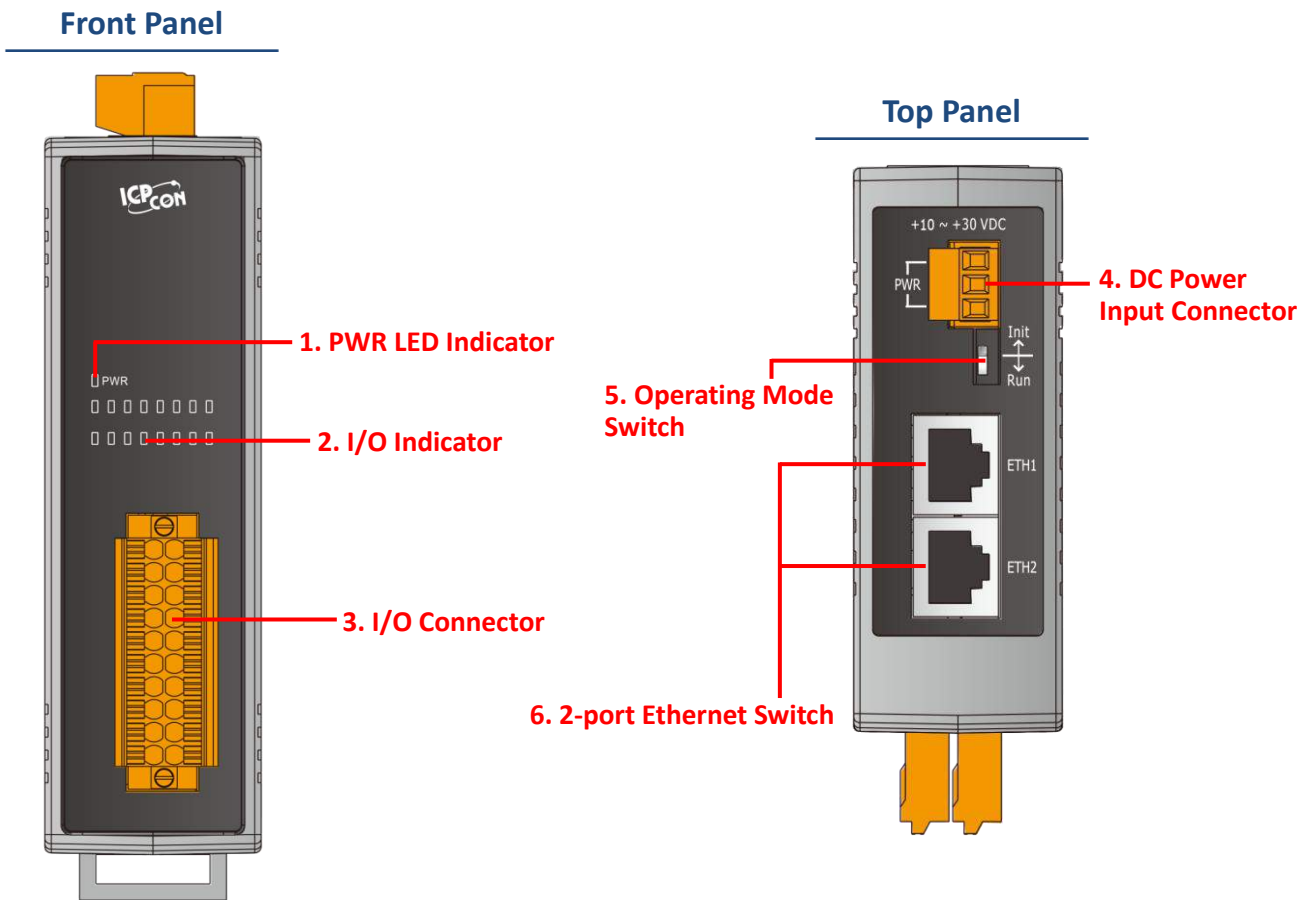

1. PWR LED Indicator

Once power is supplied to the ET-2200 series module, the system LED indicator will illuminate.

2. I/O Indicator

The exact design and functionality depends on the module type which indicates the I/O status.

3. I/O Connector

For more detailed information regarding the pin assignments for the I/O connector, refer to [Section 2.3 “Pin Assignments”](#).

4. DC Power Input Connector

The definition for “+Vs” and “GND” for use as the power supply applies to all types of ET-2200 series module. The valid power voltage range is from **+10 to +30 V_{DC}**.

The definition for “**F.G.**” (**Frame Ground**):

Electronic circuits are constantly vulnerable to Electrostatic Discharge (ESD), which becomes worse in a continental climate area. ET-2200 series module feature a new design for the frame ground, which provides a path that bypasses ESD, resulting in an enhanced ESD protection capability and ensuring that the module is more reliable.

5. Operating Mode Switch

Init Mode: Use factory default settings for troubleshooting.

Run Mode: Use customer settings for normal operations.

The operating mode switch is set to the “**Run**” position by default. Refer to [Section 3.1 “Configuring the Boot Mode”](#) for more information.

6. 2-Port Ethernet Switch

The ET-2200 series module are equipped with two RJ-45 10/100 Base-TX Ethernet switch ports. When an Ethernet link is detected and an Ethernet packet is received, the **Green LED** indicator and the **Yellow LED** indicator will be illuminated.

2.2 Specification

2.2.1 System Specification

Model	ET-2242	ET-2251	ET-2254(P)	ET-2255	ET-2260	ET-2261	ET-2268
System							
CPU	32-bit ARM						
Communication							
Ethernet Port	2 x RJ-45, 10/100 Base-Tx, switch Ports						
Protocol	Modbus TCP, Modbus UDP						
Security	Password and IP Filter						
I/O Pair Connection	Yes (Push, Polling)						
Dual Watchdog	Yes, Module, Communication (Configurable)						
LAN Bypass	Yes						
LED Indicators							
System Running	Yes						
Ethernet Link/Act	Yes						
DI/DO status	Yes						
2-Way Isolation							
Ethernet	1500 V _{DC}						
I/O	3000 V _{DC}						
EMS Protection							
ESD (IEC 61000-4-2)	±8 kV Contact for Each Terminal and ±16 kV Air for Random Point						
EFT (IEC 61000-4-4)	±4 kV for Power Line						
Surge (IEC 61000-4-5)	±3 kV for Power Line						
Power							
Reverse Polarity Protection	Yes						
Powered from Terminal Block	+10 ~ +30 V _{DC}						
Consumption	3.2 W (Max.)	2.9 W (Max.)	3.3 W (Max.)	2.9 W (Max.)	3.3 W (Max.)	3.3 W (Max.)	3.3 W (Max.)
Mechanical							
Dimensions (L x W x H)	127 mm x 33 mm x 99 mm						
Installation	DIN-Rail Mounting						
Environment							
Operating Temperature	-25 ~ +75°C						
Storage Temperature	-30 ~ +80°C						
Humidity	10 ~ 90% RH, Non-condensing						

2.2.2 I/O Specification

2.2.2.1 ET-2242

Model	ET-2242
Digital Output	
Channels	16
Type	Open collector
Sink/Source (NPN/PNP)	Sink
Load Voltage	+3.5 V ~ +50 V PASS
Max. Load Current	650 mA/Channel PASS
Overload Protection	1.4 A (with short-circuit protection)
Overvoltage Protection	+60 V _{DC}

2.2.2.2 ET-2251

Model	ET-2251	
Digital Input/Counter		
Channels	16	
Contact	Wet Contact	
Sink/Source (NPN/PNP)	Sink/Source	
On Voltage Level	+5 V _{DC} ~ +50 V _{DC}	
Off Voltage Level	+1 V _{DC} Max.	
Input Impedance	7.5 k Ω	
Counters	Max. Count	4,294,967,295 (32 bits)
	Max. Input Frequency	3 kHz
	Programmable Digital Filter	1 ~ 6500 ms (0.08 Hz ~ 500 Hz)
Overvoltage Protection	+70 V _{DC}	

2.2.2.3 ET-2254/2254P

Model		ET-2254	ET-2254P
I/O Type		By Wire Connection, Configurable Universal DIO	
I/O Channels		16	
Digital Input			
Type		Dry Contact	
Sink/Source (NPN/PNP)		Source	
On Voltage Level		Close to GND	
Off Voltage Level		Open	
Input Impedance		3 k Ω , 0.5 W	7.5 k Ω , 1 W
Counters	Max. Count	4,294,967,295 (32 bits)	
	Max. Input Frequency	3 kHz	2.5 kHz
	Programmable Digital Filter	1 ~ 6500 ms (0.08 Hz ~ 500 Hz)	
Digital Output			
Type		Open-collector (Sink)	
Max. Load Current		100 mA/channel	400 mA/channel
Load Voltage		+5 V _{DC} to +30 V _{DC}	+5 V _{DC} to +50 V _{DC}
Short Circuit Protection		-	Yes
Power-on Value		Yes, Configurable	
Safe Value		Yes, Configurable	

2.2.2.4 ET-2255

Model		ET-2255
Digital Input/Counter		
Channels		8
Contact		Wet Contact
Sink/Source (NPN/PNP)		Sink/Source
On Voltage Level		+5 V _{DC} ~ +50 V _{DC}
Off Voltage Level		+1 V _{DC} Max.
Input Impedance		7.5 kΩ
Counters	Max. Count	4,294,967,295 (32 bits)
	Max. Input Frequency	3 kHz
	Programmable Digital Filter	1 ~ 6500 ms (0.08 Hz ~ 500 Hz)
Overvoltage Protection		+70 V _{DC}
Digital Output		
Channels		8
Type		Open Collector
Sink/Source (NPN/PNP)		Sink
Load Voltage		+3.5 V ~ +50 V
Max. Load Current		60 mA/Channel
Overload Protection		1.4 A (with short-circuit protection)
Overvoltage Protection		+60 V _{DC}

2.2.2.5 ET-2260

Model		ET-2260
Digital Input/Counter		
Channels		6
Contact		Wet Contact
Sink/Source (NPN/PNP)		Sink/Source
On Voltage Level		+5 V _{DC} ~ +50 V _{DC}
Off Voltage Level		+3.5 V _{DC} Max.
Input Impedance		7.5 kΩ
Counters	Max. Count	4,294,967,295 (32 bits)
	Max. Input Frequency	3 kHz
	Programmable Digital Filter	1 ~ 6500 ms (0.08 Hz ~ 500 Hz)
Overvoltage Protection		+70 V _{DC}
Power Relay		
Channels		6
Type		Power Relay, Form A (SPST N.O.)
Contact Rating		5 A @ 250 V _{AC} /24 V _{DC} (Resistive Load)
Min. Contact Load		10 mA @ 5 V
Operate Time		10 ms (max.)
Release Time		5 ms (max.)
Mechanical Endurance		2 × 10 ⁷ ops.
Electrical Endurance		10 ⁵ ops.
Power-on Value		Yes, Configurable
Safe Value		Yes, Configurable

2.2.2.6 ET-2261

Model	ET-2261
Power Relay	
Channels	10
Type	Power Relay, Form A (SPST N.O.)
Contact Rating	5 A @ 250 V _{AC} /24 V _{DC} (Resistive Load)
Min. Contact Load	10 mA @ 5 V
Operate Time	10 ms (max.)
Release Time	5 ms (max.)
Mechanical Endurance	2 × 10 ⁷ ops.
Electrical Endurance	10 ⁵ ops.
Power-on Value	Yes, Configurable
Safe Value	Yes, Configurable

2.2.2.7 ET-2268

Model		ET-2268
Relay Output		
Channels		8 (Form A x 4, Form C x 4)
Relay Type		Signal Relay
Form A	Contact Rating	2 A @ 30 V _{DC}
		0.24 A @ 220 V _{DC}
		0.25 A @ 250 V _{DC}
	Min. Contact Load	10 mA @ 20 mV
	Contact Material	Silver Nickel, Gold-covered
	Operate Time	3 ms (Typical)
	Release Time	4ms (Typical)
Form C	Contact Rating	2 A @ 30 V _{DC}
		0.24 A @ 220 V _{DC}
		0.25 A @ 250 V _{DC}
	Min. Contact Load	10 mA @ 20 mV
	Contact Material	Silver Nickel, Gold-covered
	Operate Time	3 ms (Typical)
	Release Time	4ms (Typical)
Mechanical Endurance	10 ⁸ ops	
	Electrical Endurance	2 x 10 ⁵ ops
Surge Strength		2000 V _{DC}
Power-on Value		Yes, Configurable
Safe Value		Yes, Configurable

2.3 Pin Assignments

2.3.1 ET-2242

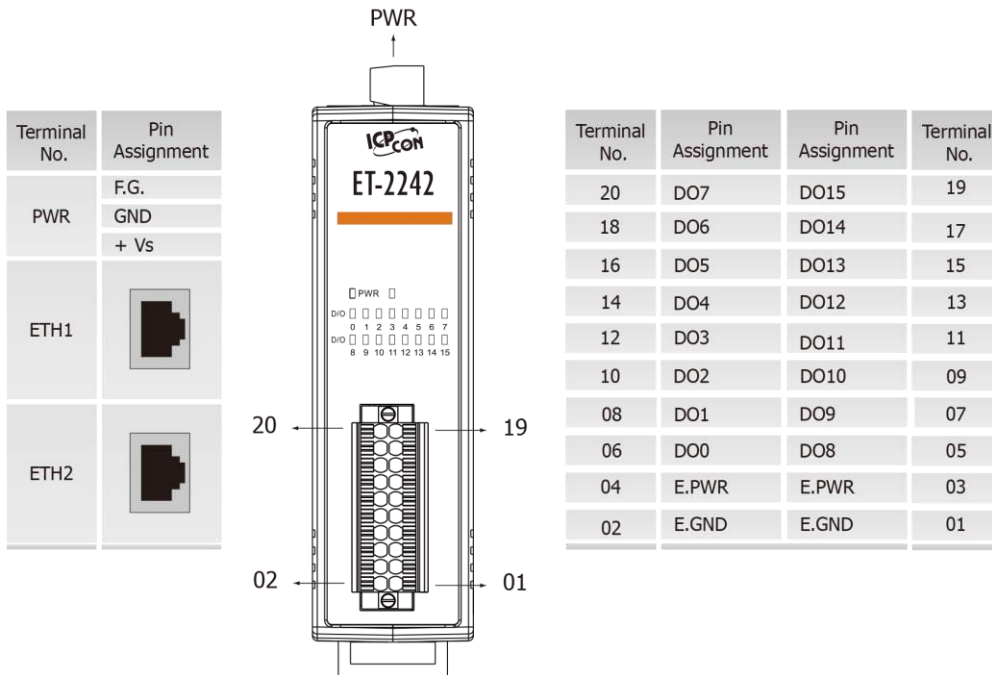

2.3.2 ET-2251

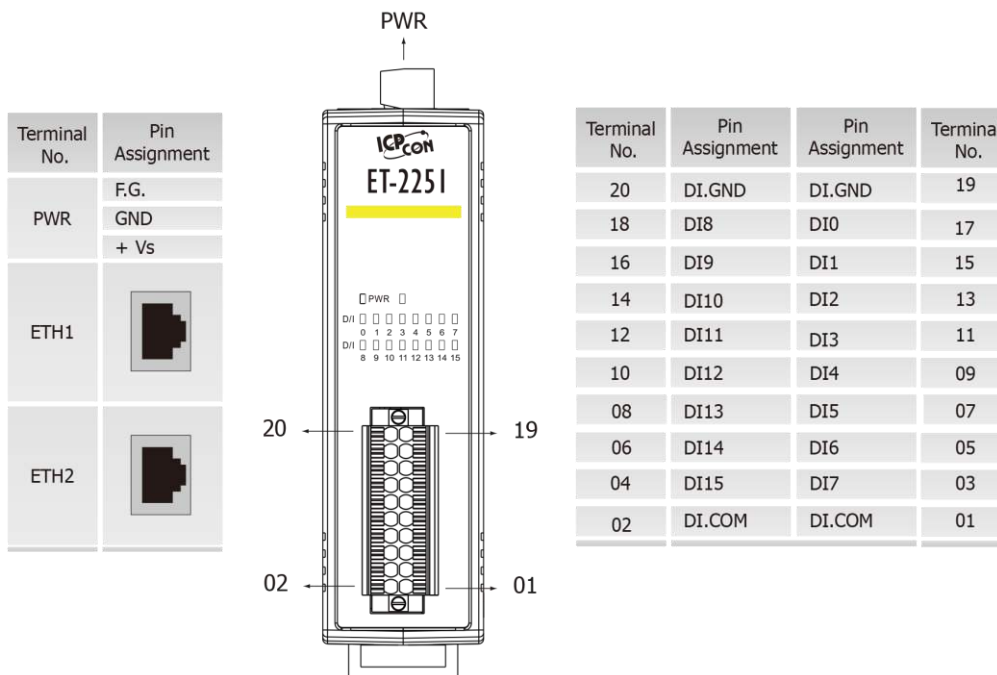

2.3.3 ET-2254/2254P

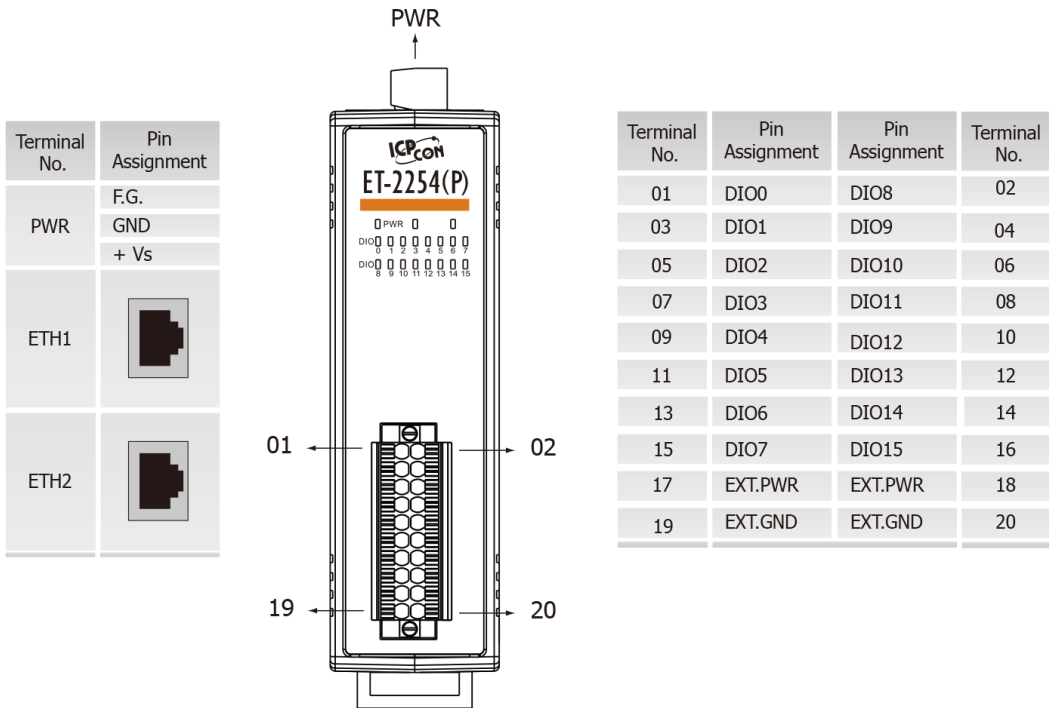

2.3.4 ET-2255

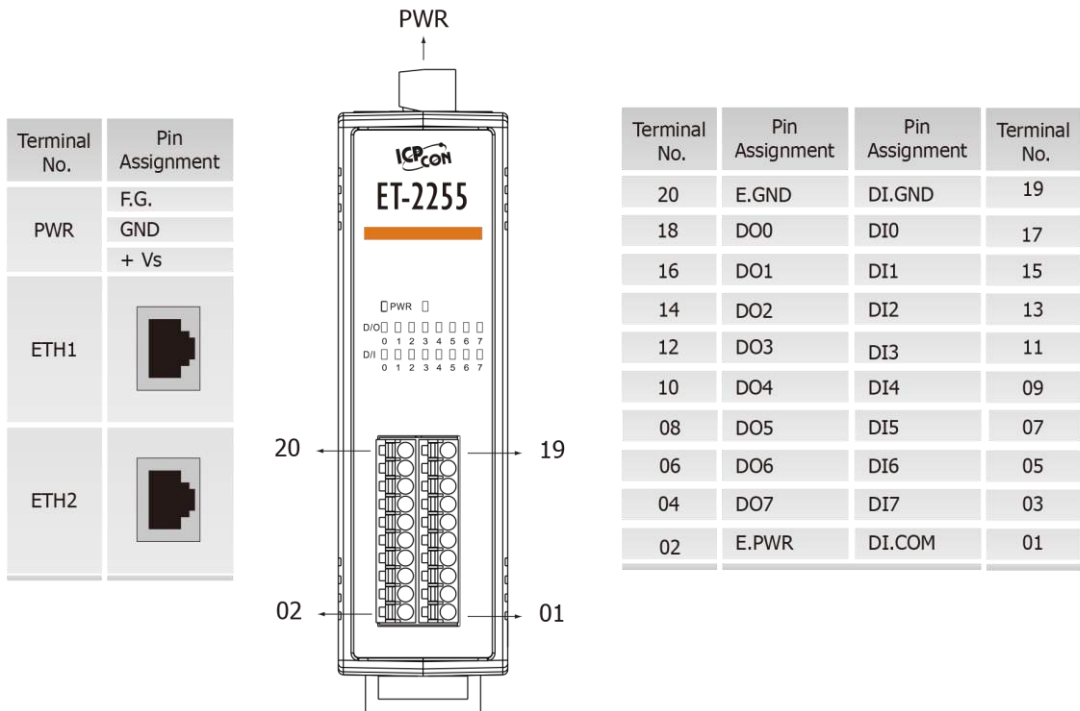

2.3.5 ET-2260

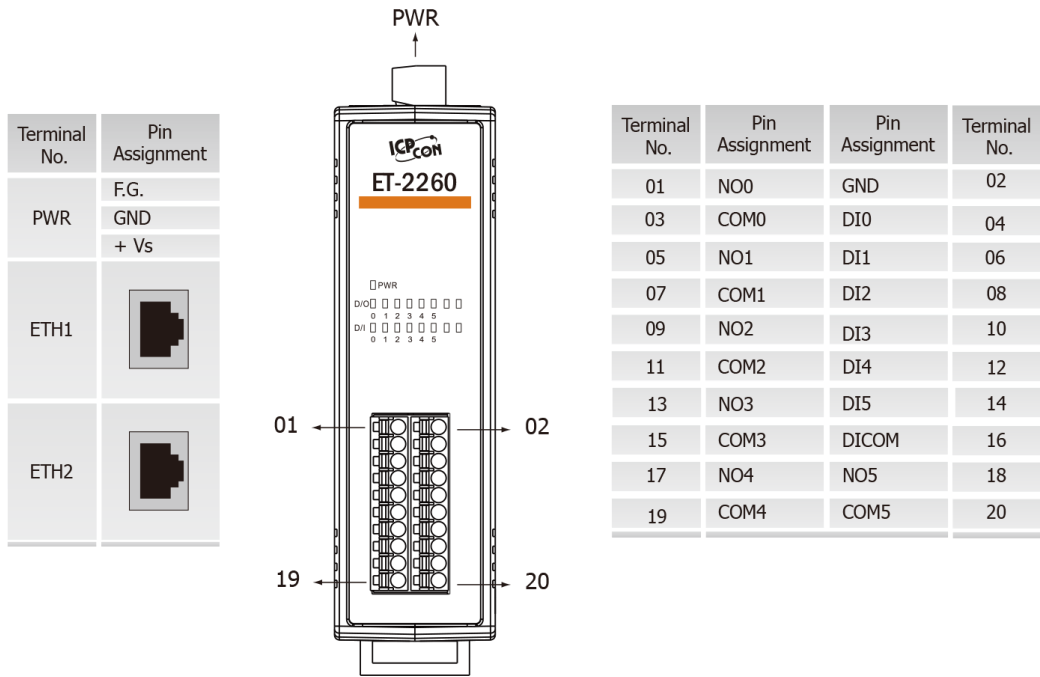

2.3.6 ET-2261

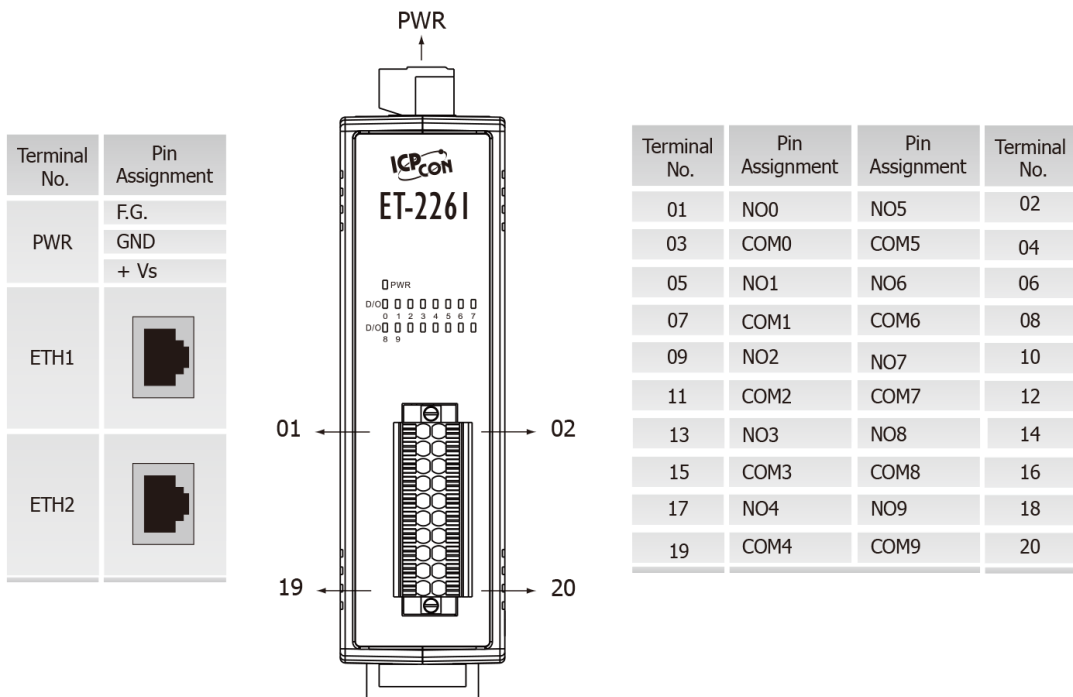

2.3.7 ET-2268

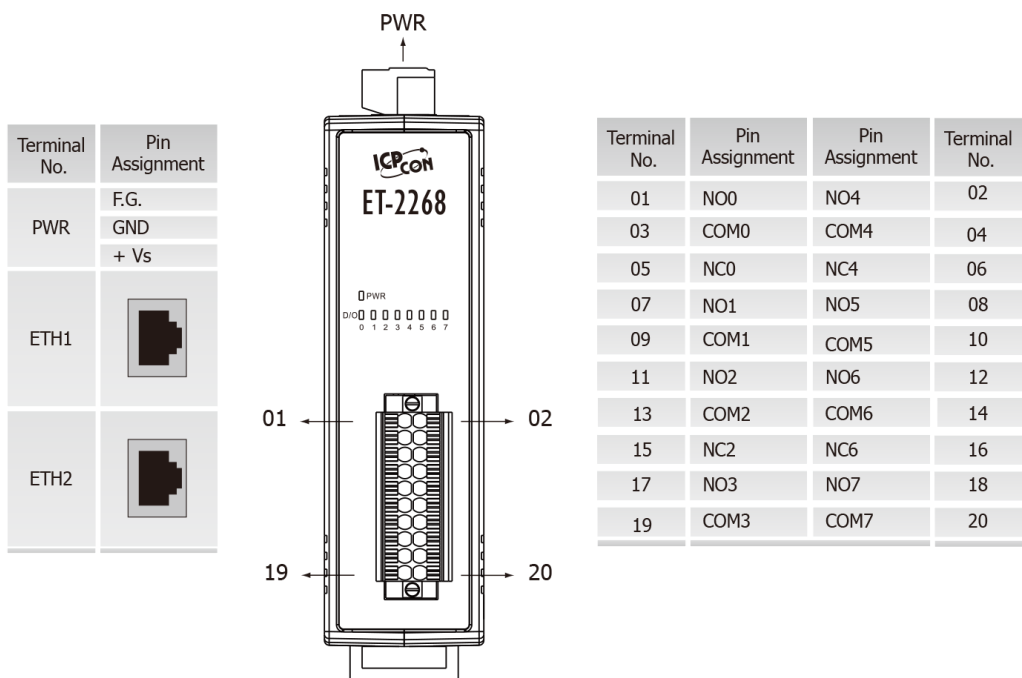

2.4 Wiring Connections

2.4.1 Input Wiring

➤ Input Wiring for the **ET-2251/2255/2260**:

Model	Digital Input/Counter	Readback as 1	Readback as 0
ET-2251 ET-2255 ET-2260	Dry Contact	Close to GND	Open
ET-2260	Sink	+10 ~ +50 Vdc	OPEN or <4 Vdc
	Source	+10 ~ +50 Vdc	OPEN or <4 Vdc
ET-2251 ET-2255	Sink	+5 ~ +50 Vdc	OPEN or <1 Vdc
	Source	+5 ~ +50 Vdc	OPEN or <1 Vdc

➤ Input Wiring for the **ET-2254/2254P**:

Model	Input Type	ON State LED ON Readback as 1	OFF State LED OFF Readback as 0
ET-2254 ET-2254P	Dry Contact	Close to GND	Open

2.4.2 Output Wiring

➤ Output Wiring for **ET-2242/2254/2254P/2255**:

Model	Output Type	ON State Readback as 1	OFF State Readback as 0
ET-2242 ET-2254 ET-2254P ET-2255	Drive Relay		
	Resistance Load		

➤ Output Wiring for **ET-2260/2261**:

Model	Power Relay	ON State Readback as 1
ET-2260 ET-2261	Relay Output	
		OFF State Readback as 0

➤ Output Wiring for ET-2268:

Model	Relay Output	ON State Readback as 1	OFF State Readback as 0
ET-2268	Form A Relay in NO1, NO3, NO4, NO7		
	Form C Relay in NO0, NO2, NO4, NO6		

Note for the ET-2260/2261/2268:

When inductive loads are connected to the relays, a large counter electromotive force may occur when the relay actuates because of the energy stored in the load. These flyback voltages can severely damage the relay contacts and greatly shorten the relay life. Limit these flyback voltages at your inductive load by installing a flyback diode for DC loads or a metal oxide varistor for AC loads.

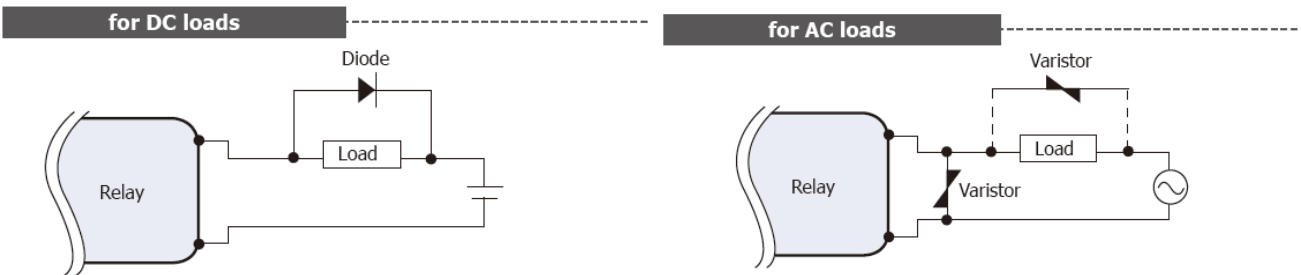

Varistor Selection:

Operating Voltage	Varistor Voltage	Max. Peak Current
100 ~ 120 V _{AC}	240 ~ 270 V _{AC}	> 1000 A
200 ~ 240 V _{AC}	440 ~ 470 V _{AC}	> 1000 A

2.5 Wiring to the Connector

➤ **Insulated Terminals Dimensions:**

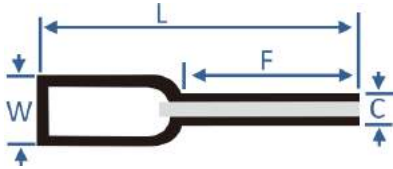

Dimensions (Unit: mm)				
Item NO.	F	L	C	W
CE007512	12.0	18.0	1.2	2.8

➤ **A tip for connecting the wire to the connector**

1. Use the blade of the flat-head screwdriver to push down the wire clamp.

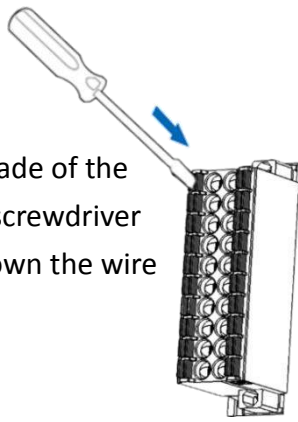

2. While holding the screwdriver in place, insert the wire into the terminal block.

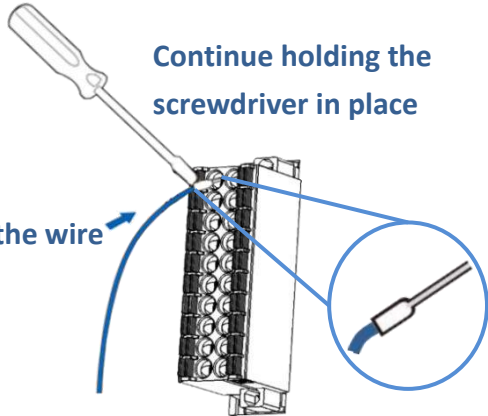

Continue holding the screwdriver in place

Insert the wire

➤ **A tip for removing the wire from the connector**

1. Use the blade of the flat-head screwdriver to push down the wire clamp.

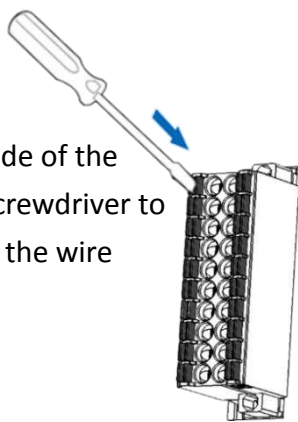

2. While holding the screwdriver in place, remove the wire from the terminal block.

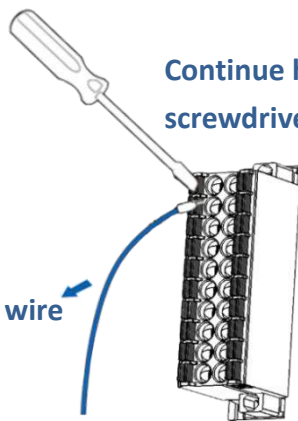

Continue holding the screwdriver in place

Remove the wire

2.6 Dimensions

The following diagrams provide the dimensions of the ET-2200 series module and can be used as a reference when defining the specifications for any custom enclosures. All dimensions are in millimeters.

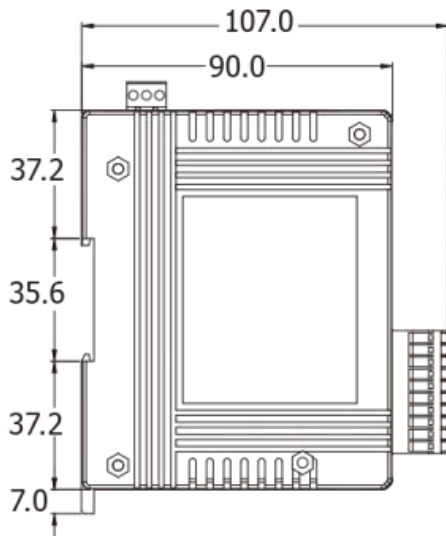

Left Side View

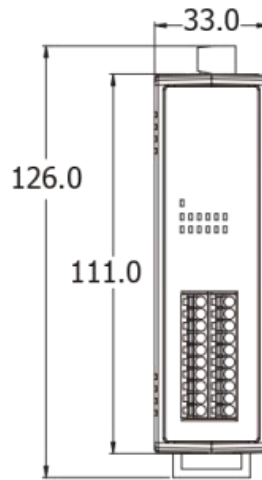

Front View

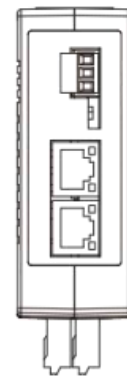

Top View

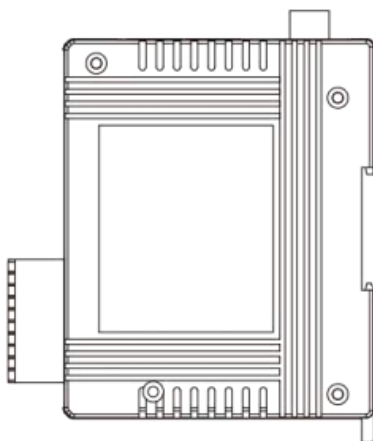

Right Side View

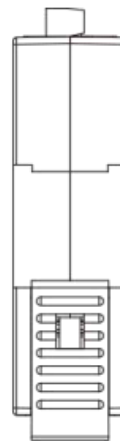

Rear View



Bottom View

3. Getting Started

This chapter provides a basic overview of how to configure and operate your ET-2200 series module.

3.1 Configuring the Boot Mode

The ET-2200 series modules have two operating modes that can be selected by using the switch mechanism incorporated on the chassis.

 *Note that the module must be rebooted after changing the operating mode.*

➤ Init Mode

Init Mode should only be selected for troubleshooting.

1. Put the switch in "**Init**" position and then reboot the module to load factory settings.
2. Use eSearch Utility to reconfigure the module's network settings.
3. Put the switch back in "**Run**" position and then reboot the module to work in normal mode.

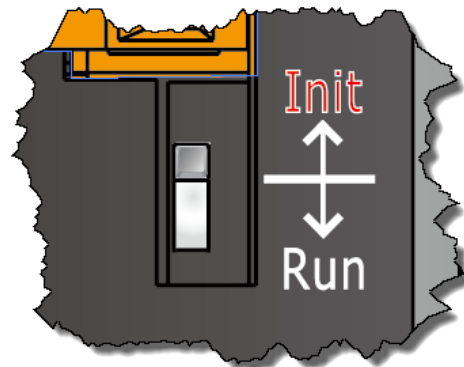

➤ Run Mode

Run Mode is the default operating mode and should be used in most cases.

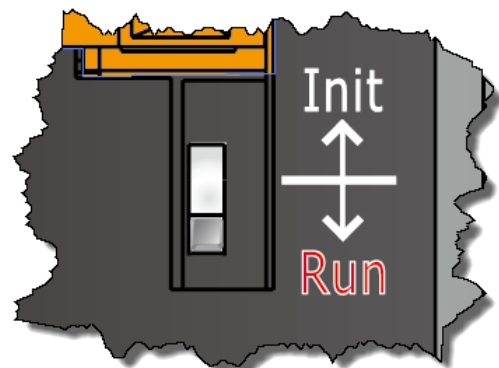

3.2 Connecting the Power and the Host PC

Step 1: Connect both the ET-2200 module and the Host PC to the same sub network or the same Ethernet Switch

Ensure that the network settings on the Host PC have been correctly configured and are functioning normally. Ensure that the Windows firewall or any Anti-Virus firewall is properly configured to allow incoming connections, or temporarily disable these functions, otherwise the “Search Servers” function in the eSearch Utility described in [Section 3.3 “Configuring the Network Settings”](#) the may not perform as expected. Contact the System Administrator for instructions of how to do this.

Step 2: Apply power to the ET-2200 module. The valid power voltage range is from +10 to +30 V_{DC}

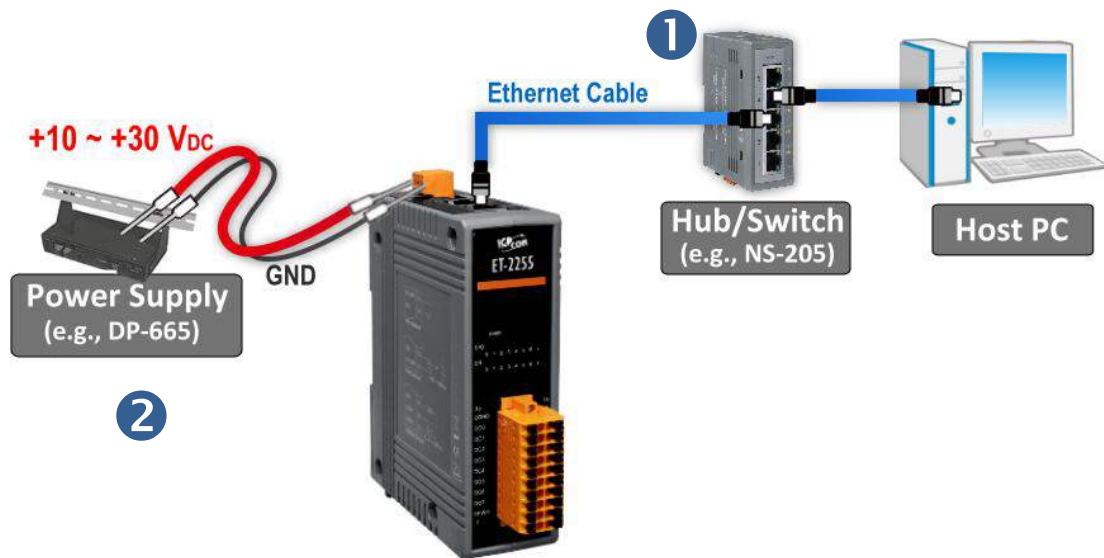

Step 3: Verify that the “PWR” LED indicator on the ET-2200 module is flashing



3.3 Configuring the Network Settings

Step 1: Get the eSearch Utility



The eSearch Utility can be obtained either from the companion CD at:
CD:\Napdos\Software\eSearch\

Or from the ICP DAS web site at:

<http://ftp.icpdas.com/pub/cd/tinymodules/napdos/software/esearch/>

Step 2: Install the eSearch Utility

Follow the steps as suggested by the eSearch setup wizard to finish the installation.



After the installation has been completed, a new short cut for the eSearch Utility will be displayed on your desktop.

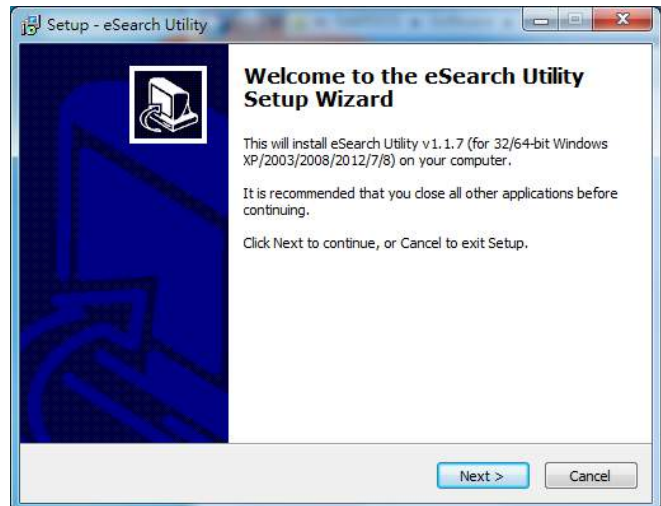

Step 3: Click the "Search Servers" button to search for the ET-2200 module

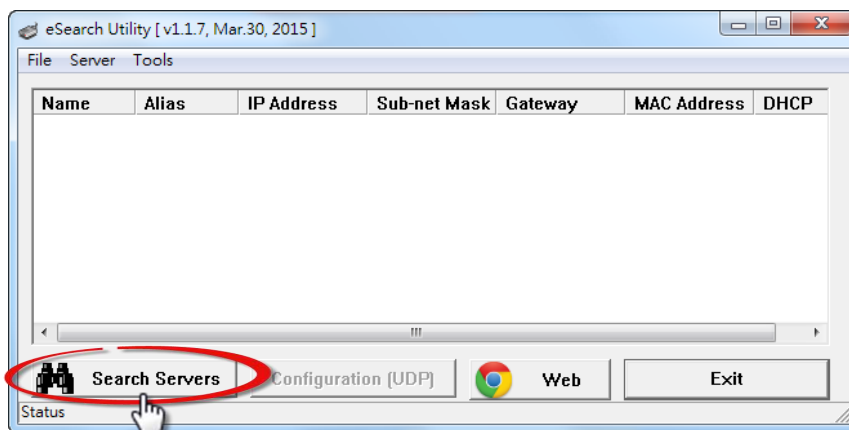

Step 4: Once the search process is complete, double-click the name of the ET-2200 module to open the “Configure Server (UDP)” dialog box

Factory Default Settings for the ET-2200 Series, as follows:

IP	192.168.255.1
Gateway	192.168.0.1
Mask	255.255.0.0

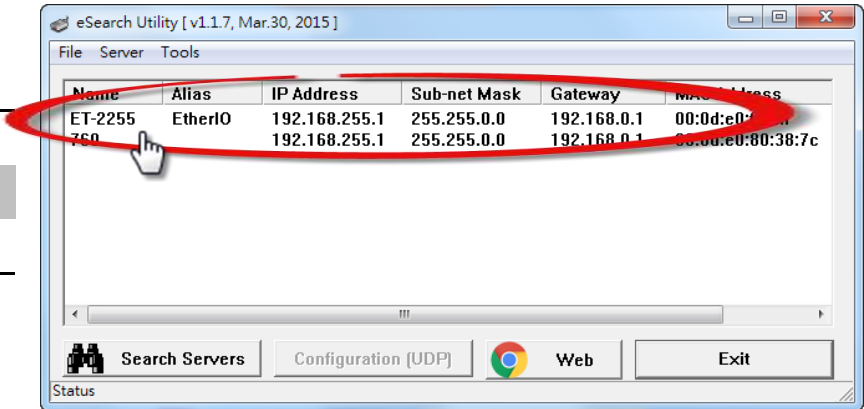

Step 5: Assign a new IP address and then click the “OK” button.

Enter the relevant values for the **IP Address, Subnet Mask and Gateway**, etc., and then click the **“OK”** button. The new settings for the ET-2200 module will take effect within 2 seconds. If the correct network configuration information is unknown, contact the Network Administrator to obtain the relevant details.

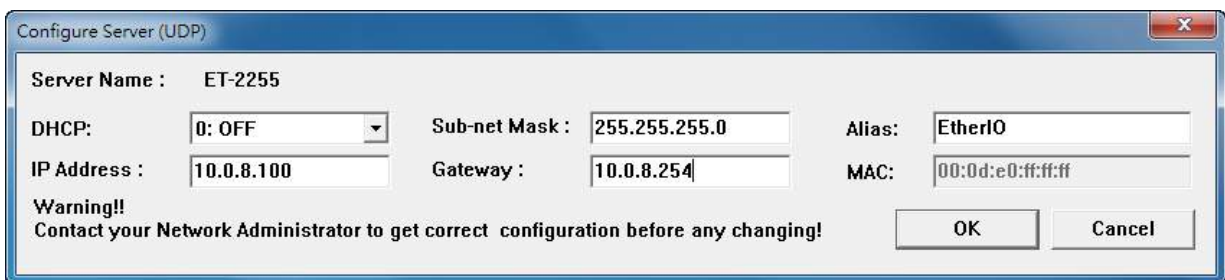

Step 6: Wait for 2 seconds and then click the “Search Servers” button again to ensure that the ET-2200 module is operating correctly using the new configuration

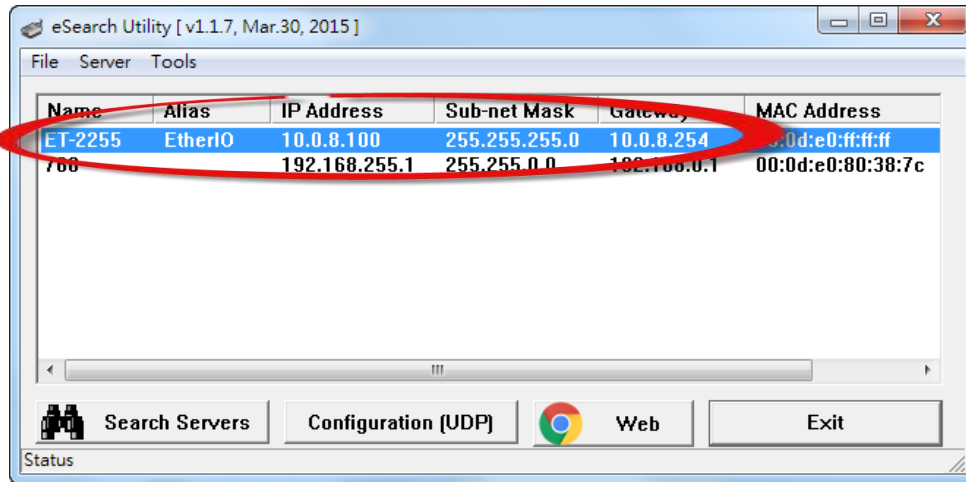

3.4 Modbus TCP Testing

Step 1: In the eSearch Utility, Select the “Modbus TCP Master” item from the “Tools” menu to open the Modbus TCP Master Utility.

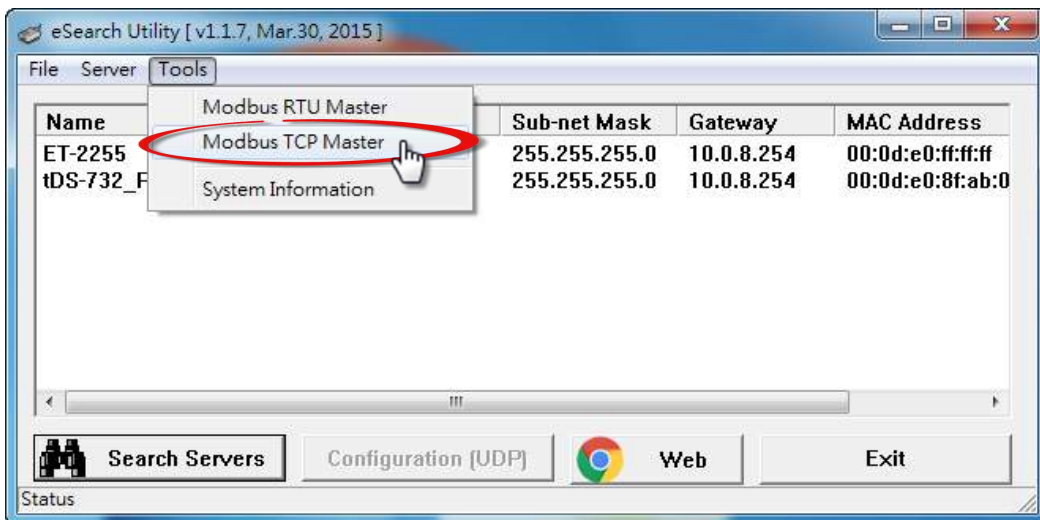

Step 2: Enter the “IP address” and “TCP Port” information for the ET-2200 module in the “Modbus TCP” section, and then click the “Connect” button to connect to the ET-2200.

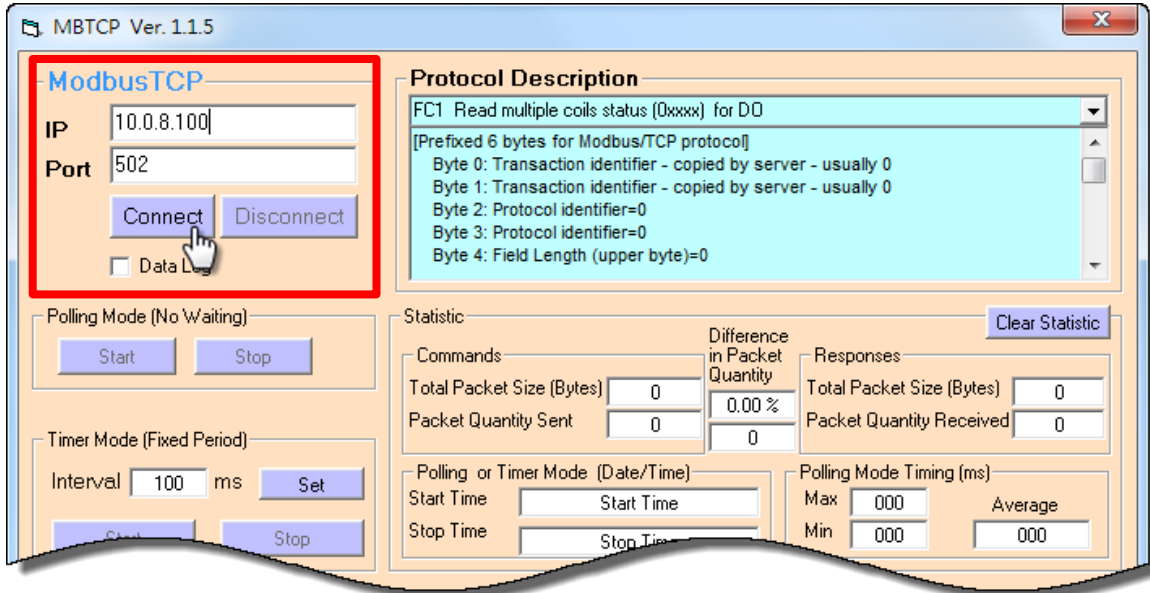

Step 3: Refer to the “Protocol Description” filed in the top right-hand section fo the Modbus Utility windows. You can send a request command and confirm that the response is correct.

For example, if the Modbus NetID (see [Section 4.3.1](#)) for the ET-2200 is 1, send the command “1 2 0 0 0 6 1 3 1 3 0 1” to read the module name, the response will be “1 2 0 0 0 5 1 3 2 22 55” (Refer to [Section 6.2 “Modbus Message Structure”](#) for more details information).

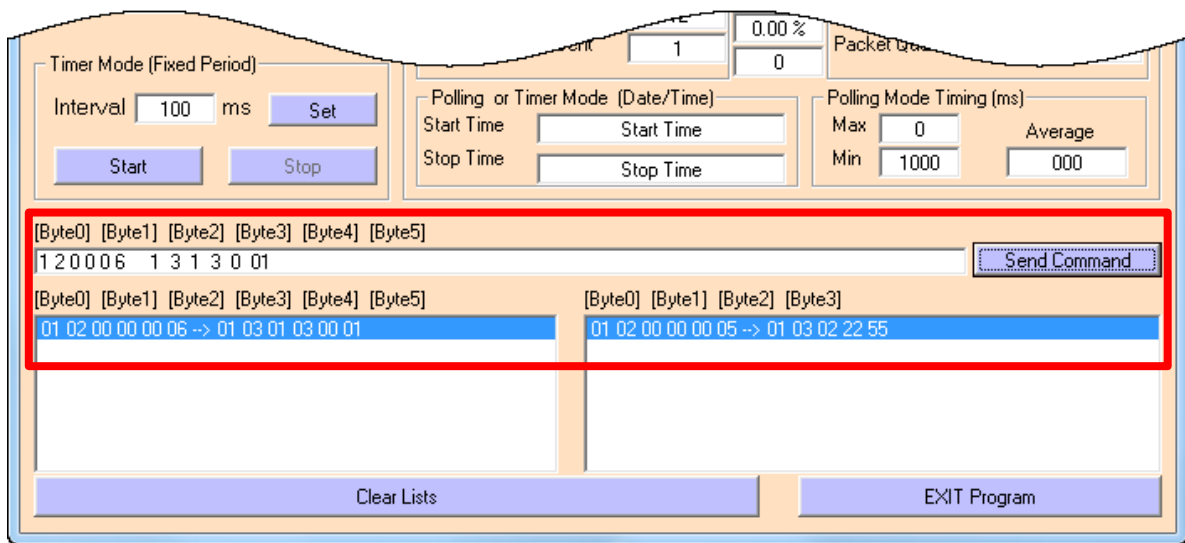

4. Web Configuration

All ET-2200 series module contain an advanced embedded web configuration system that provides I/O accessibility to the ET-2200 series module via a web browser.

4.1 Logging in to the Web Server

You can access the embedded ET-2200 series web server from any computer that has an Internet connection.

Step 1: Launch web browser



Open a standard web browser. For example, Mozilla Firefox, Google Chrome and Internet Explorer are reliable and popular internet browsers that can be used to configure ET-2200 series module.

 *Note that if you intend to use Internet Explorer, ensure that the cache function is disabled in order to avoid browser access errors. For more information, please refer to [“FAQ_General_001: How to avoid a browser access error that causes a blank page to be displayed when using Internet Explorer”](#).*

Step 2: Enter the URL for the ET-2200 module in the address bar of the browser or click the “Web” button in the eSearch Utility

Ensure that you have correctly configured the network settings for the ET-2200 series module, or refer to [Section 3.3 “Configuring the Network Settings”](#).

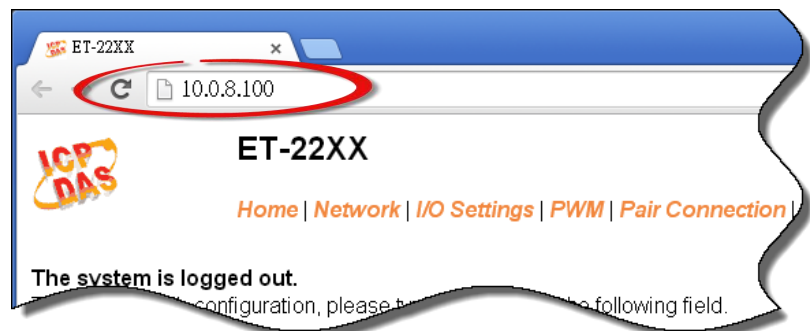

Step 3: Enter the password

Once the login screen is displayed, enter the password in the login password field (use the default password “Admin”), and then click the “Submit” button to enter the configuration web page.

The screenshot shows a web browser window with the URL 10.0.8.100. The page title is "ET-22XX" and it features the ICP DAS logo. A navigation menu includes links for Home, Network, I/O Settings, PWM, Pair Connection, Filter, Monitor, and Change Password. The main content area displays the message "The system is logged out." and instructs the user to enter a password. A text input field labeled "Login password:" with a masked password "....." and a "Submit" button are circled in red. A red callout box on the right contains a warning icon and the text: "Note: Factory Default Password: Admin". Below the input field, there are two notes: "Note: This web configuration requires JavaScript enabled in your browser (Firefox, IE...). If the web configuration does not work, please check the JavaScript settings first." and "When using IE, please disable its cache as follows. Menu items: Tools / Internet Options... / General / Temporary Internet Files / Settings... / Every visit to the page".

Step 4: Log in to the ET-2200 Web Server

After logging into the ET-2200 web server, the main page will be displayed.

The screenshot shows the main configuration page of the ET-2200 Series Ethernet I/O Module. The page title is "ET-2200 Series Ethernet I/O Module" and it features the ICP DAS logo. A navigation menu includes links for Home, Network, I/O Settings, PWM, Pair Connection, Filter, Monitor, Change Password, and Logout. The system information section displays the following details:

Model Name:	ET-2255	Alias Name:	EtherIO
Firmware Version:	v1.3.9 [Jan.20, 2016]	MAC Address:	00-0d-e0-ff-ff-ff
IP Address:	10.0.8.100	Initial Switch:	ON
TCP Port Timeout (Socket Watchdog, Seconds):	180	System Timeout (Network Watchdog, Seconds):	0

The Digital I/O section shows a row of 8 digital output (DO) buttons (DO7 to DO0) and a table for digital input (DI) channels:

DI Channel	Value	Counter / Frequency	High Latched	Low Latched
DI0:	●	-	-	-
DI1:	●	-	-	-
DI2:	●	-	-	-

4.2 Home

Clicking the **Home** tab will display to the main **Status & Configuration** page, which is divided into three sections.



ET-2200 Series Ethernet I/O Module



The first section provides basic information related to the ET-2200 series module hardware and software including items:

The Model Name, Firmware version, IP Address, Initial Switch position, Alias Name, MAC Address, and the TCP Port and System Timeout values. If the firmware for the ET-2200 series module is updated, you can use this page to check the version information for the ET-2200 software.

Model Name:	ET-2255	Alias Name:	EtherIO
Firmware Version:	v1.3.9 [Jan.20, 2016]	MAC Address:	00-0d-e0-ff-ff-ff
IP Address:	10.0.8.100	Initial Switch:	ON
TCP Port Timeout (Socket Watchdog, Seconds):	180	System Timeout (Network Watchdog, Seconds):	0

The second section provides information related to the current status of the I/O and Digital Output Control. *Note: User can click on the DO image to switch the output state.*

Digital I/O

DI Channel	Value	Counter / Frequency	High Latched	Low Latched
D07				
D06				
D05				
D04				
D03				
D02				
D01				
D00				
D10:		-	-	-
D11:		-	-	-
D12:		-	-	-
D13:		-	-	-
D14:		-	-	-
D15:		-	-	-
D16:		-	-	-
D17:		-	-	-

4.3 Network



ET-2200 Series Ethernet I/O Module

Home | **Network** | I/O Settings | Sync | PWM | Pair | Filter | Monitor | Change Password | Logout

Model Name:	ET-2255	Alias Name:	EtherIO
Firmware Version:	v1.3.9 [Jan.29, 2016]	MAC Address:	00-0d-e0-ff-ff-ff
IP Address:	10.0.8.7	Initial Switch:	ON
TCP Port Timeout (Socket Watchdog, Seconds):	180	System Timeout (Network Watchdog, Seconds)	0

Clicking the **Network** tab will display the **IP Address Configuration** page allowing you verify the current settings and configure the IP Address parameters, configure the general parameters and restore the default settings for the ET-2200 series module, each of which will be described in more detail below.

4.3.1 IP Address Configuration

IP Address Configuration

Address Type:	DHCP ▾		
Static IP Address:	255	. 255	. 255
Subnet Mask:	0	. 0	. 0
Default Gateway:	0	. 0	. 0
MAC Address:	00-0d-e0-ff-ff-ff	(Format: FF-FF-FF-FF-FF-FF)	
Modbus TCP Slave			
Local Modbus TCP port	502	(Default= 502)	
Local Modbus NetID	1	(Default= 1)	Enable ▾ (Default= Enable)
Update Settings			

The following table provides an overview of the parameters contained in the **IP Address Configuration** section:

Item	Description
Address Type	<p>Static IP: If there is no DHCP server installed in your network, you can configure the network settings manually. Refer to Section 4.3.1.2 “Manual Configuration” for more details.</p>
	<p>DHCP: Dynamic Host Configuration Protocol (DHCP) is a network application protocol that automatically assigns an IP address to each device. Refer to Section 4.3.1.1 “Dynamic Configuration” for more details.</p>
Static IP Address	<p>Each ET-2200 module connected to the network must have its own unique IP address. This parameter is used to assign a specific IP address.</p>
Subnet Mask	<p>This parameter is used to assign the subnet mask for the ET-2200 module. The subnet mask indicates which portion of the IP address is used to identify the local network or subnet.</p>
Default Gateway	<p>This parameter is used to assign the IP Address of the Gateway to be used by the ET-2200 module. A Gateway (or router) is a device that is used to connect an individual network to one or more additional networks.</p>
MAC Address	<p>This parameter is used to set the User-defined MAC address, which must be in the format FF-FF-FF-FF-FF-FF.</p>
Modbus TCP Slave	
Local Modbus TCP port	<p>This parameter is used to set the local port to be used by the Modbus slave device. The default value is 502.</p>
Local Modbus NetID	<p>This parameter is used to set the Network ID to be used by the Modbus slave device. The default value is 1.</p>
Update Settings	<p>Click this button to save the revised settings to the ET-2200 module.</p>

4.3.1.1 Dynamic Configuration

Dynamic configuration is very easy to perform. If a DHCP server is connected to you network, a network address can be dynamically configured by using the following procedure:

Step 1: Select “**DHCP**” from the **Address Type** drop-down menu.

Step 2: Click the “**Update Settings**” button to complete the configuration.

Address Type:	DHCP			1
Static IP Address:	10	0	8	102
Subnet Mask:	255	255	255	0
Default Gateway:	10	0	8	254
MAC Address:	00-0d-e0-c7-8a-9f			(Format: FF-FF-FF-FF-FF-FF)
Local Modbus TCP port	502			(Default= 502)
Local Modbus NetID	1	(Default= 1)	Enable	(Default= Enable)
				Update Settings 2

4.3.1.2 Manual Configuration

When using manual configuration, the network settings should be assigned in the following manner:

Step 1: Select “**Static IP**” from the **Address Type** drop-down menu.

Step 2: Enter the relevant details in the respective **network settings** fields.

Step 3: Click the “**Update Settings**” button to complete the configuration.

Address Type:	Static IP			1
Static IP Address:	10	0	8	102
Subnet Mask:	255	255	255	0
Default Gateway:	10	0	8	254
MAC Address:	00-0d-e0-c7-8a-9f			(Format: FF-FF-FF-FF-FF-FF)
Local Modbus TCP port	502			(Default= 502)
Local Modbus NetID	1	(Default= 1)	Enable	(Default= Enable)
				Update Settings 3

4.3.2 General Settings

General Settings

Ethernet Speed:	Auto ▾ (Auto=10/100 Mbps Auto-negotiation)
System Timeout: (Network Watchdog)	0 (30 ~ 65535 s, Default= 0, Disable= 0) Action:Reboot
TCP Timeout:	180 (5 ~ 65535 s, Default= 180, Disable= 0) Action:Cut-off
UDP Configuration:	Enable ▾ (Enable/Disable the UDP Configuration, Enable=default.)
Web Auto-logout:	10 (1 ~ 65535 minutes, Default= 10, Disable= 0)
Alias Name:	EtherIO (Max. 18 chars)
<input type="button" value="Update Settings"/>	

The following table provides an overview of the parameters contained in the **General Settings** section:

Item	Description
Ethernet Speed	This parameter is used to set the Ethernet speed. The default value is Auto (Auto = 10/100 Mbps Auto-negotiation).
System Timeout (Network Watchdog)	This parameter is used to configure the system timeout value. If there is no activity on the network for a certain period of time, the system will be rebooted based on the configured system timeout value.
TCP Timeout (Seconds)	This parameter is used to configure the TCP timeout value. If Modbus TCP communication is idle for a certain period of time, the system will cut off the connection.
UDP Configuration	This parameter is used to enable or disable UDP configuration function.
Web Auto-logout	This parameter is used to configure the automatic logout value. If there is no activity on the web server for a certain period of time, the current user account will automatically logged out.
Alias Name	This parameter is used to assign an alias name for each ET-2200 module to assist with easy identification.
Update Settings	Click this button to save the revised settings to the ET-2200 module.

4.3.3 Restore Factory Defaults

Restore Factory Defaults

Restore all options to their factory default states:	Restore Defaults
Forced Reboot	Reboot

➤ **Restore all options to their factory default states**

To reset all parameters to their original factory default settings, use the following procedure:

- Step 1:** Click the “Restore Defaults” button to reset the configuration.
- Step 2:** Click the “OK” button in the message dialog box.
- Step 3:** Check whether the module has been reset to the original factory default settings for use with the eSearch Utility. Refer to [Section 3.3 “Configuring the Network Settings”](#).

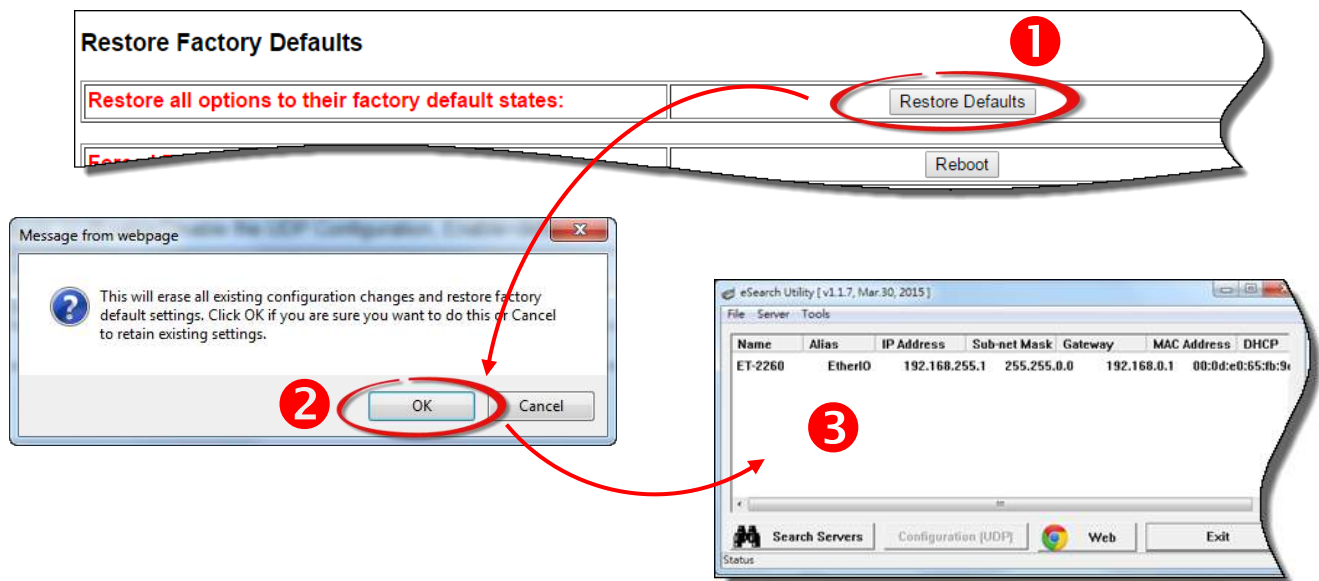

The following table provides an overview of the factory default settings:

Factory Default Settings	
IP Address	192.168.255.1
Gateway Address	192.168.0.1
Subnet Mask	255.255.0.0

➤ Forced Reboot

The **Forced Reboot** function: can be used to force the ET-2200 module to reboot or to remotely reboot the device. After the ET-2200 module has rebooted, the original login screen will be displayed requesting that you enter your Login Password before continuing.

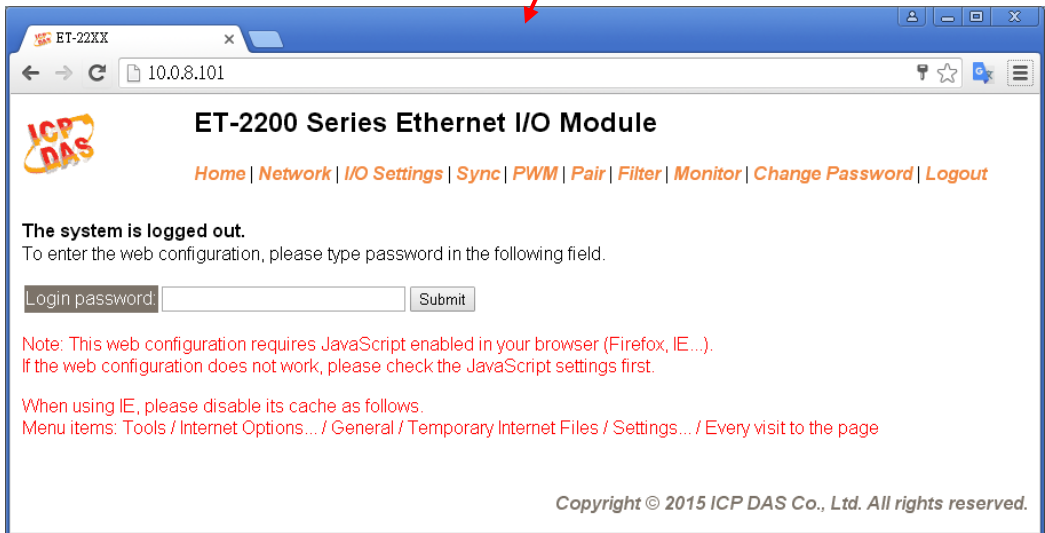
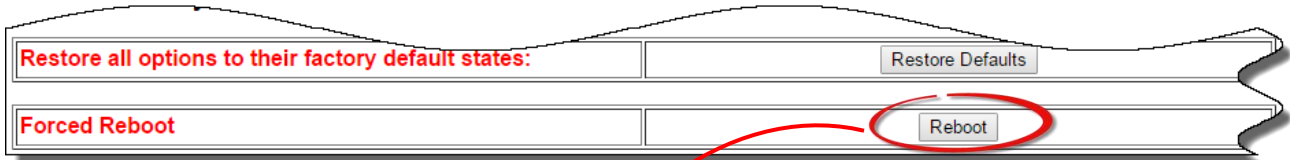

4.3.4 Firmware Update

Firmware Update

If the remote firmware update is failed, then the traditional firmware update (on-site) is required to make the module working again.

- Step 1: Refer to firmware update manual first.
- Step 2: Run eSearch Utility to prepare and wait for update.
- Step 3: Click the **[Update]** button to **reboot** the module and start update.
- Step 4: Configure the module again.

Update

For detailed information about how to remote update the Firmware for the ET-2200 module, refer to the **ET-2200_Firmware_Update_vxxx_en.pdf**.

The location of the user manual on the CD and the download address are shown below:



CD:\\ NAPDOS\\ET2200\\Firmware\\



<http://ftp.icpdas.com/pub/cd/6000cd/napdos/et2200/firmware/>

4.4 I/O Settings



ET-2200 Series Ethernet I/O Module

Home | Network | **I/O Settings** | Sync | PWM | Pair | Filter | Monitor | Change Password | Logout

Model Name:	ET-2255	Alias Name:	EtherIO
Firmware Version:	v1.3.9 [Jan.29, 2016]	MAC Address:	00-0d-e0-ff-ff-ff
IP Address:	10.0.8.7	Initial Switch:	ON
TCP Port Timeout (Socket Watchdog, Seconds):	180	System Timeout (Network Watchdog, Seconds)	0

Clicking the **I/O Settings** tab will display the **DO Control and DI/DO Configuration** page allowing you configure the Digital Input and Digital Output parameters for the ET-2200 series module. This page including Digital Output control, DI/DO Configuration, etc., each of which will be described in more detail below.

4.4.1 DO Control

DO Control

Set DO Value	<input type="text" value="0x0"/>	bit 7~4(<input type="checkbox"/> <input type="checkbox"/> <input type="checkbox"/> <input type="checkbox"/>)	bit 3~0(<input type="checkbox"/> <input type="checkbox"/> <input type="checkbox"/> <input type="checkbox"/>)
<input type="button" value="Update Settings"/>			

The following table provides an overview of the parameters contained in the **Digital Output Control** section:

Item	Description
Set DO value	This parameter is used to manually assign a specific a value for the DO.
Update Settings	Click this button to set the revised settings to the ET-2200 module.

4.4.2 DI/DO Configuration

DI/DO Configuration:

Digital Output																	
Watchdog Timeout (seconds):	<input type="text" value="0"/> (10 ~ 65535 Seconds, Default= 0, Disable= 0)																
Enable Watchdog	<input type="text" value="0x0"/> bit 7~4(<input type="checkbox"/> <input type="checkbox"/> <input type="checkbox"/> <input type="checkbox"/>) bit 3~0(<input type="checkbox"/> <input type="checkbox"/> <input type="checkbox"/> <input type="checkbox"/>)																
Safe Value	<input type="text" value="0x0"/> bit 7~4(<input type="checkbox"/> <input type="checkbox"/> <input type="checkbox"/> <input type="checkbox"/>) bit 3~0(<input type="checkbox"/> <input type="checkbox"/> <input type="checkbox"/> <input type="checkbox"/>)																
Power-On Value	<input type="text" value="0x0"/> bit 7~4(<input type="checkbox"/> <input type="checkbox"/> <input type="checkbox"/> <input type="checkbox"/>) bit 3~0(<input type="checkbox"/> <input type="checkbox"/> <input type="checkbox"/> <input type="checkbox"/>)																
Digital Input																	
Enable Latched DI	<input type="text" value="0"/> (Disable All= 0, Enable All= 1)																
Clear Latched Status (High)	<input type="text" value="0"/> (No Operation= 0, Clear All= 1)																
Clear Latched Status (Low)	<input type="text" value="0"/> (No Operation= 0, Clear All= 1)																
DI Filter Level	<input type="text" value="0"/> ms (1 ~ 6500 ms, Default= 0, Disable= 0)																
Digital Counter																	
Enable Digital Counter	<input type="text" value="0x0"/> Ch 7~4(<input type="checkbox"/> <input type="checkbox"/> <input type="checkbox"/> <input type="checkbox"/>) Ch 3~0(<input type="checkbox"/> <input type="checkbox"/> <input type="checkbox"/> <input type="checkbox"/>)																
Clear Digital Counter	<input type="text" value="0x0"/> Ch 7~4(<input type="checkbox"/> <input type="checkbox"/> <input type="checkbox"/> <input type="checkbox"/>) Ch 3~0(<input type="checkbox"/> <input type="checkbox"/> <input type="checkbox"/> <input type="checkbox"/>)																
Preset Counter Value	<table border="1"> <tr> <td><input type="text" value="0"/></td> <td>Ch07</td> <td><input type="text" value="0"/></td> <td>Ch06</td> <td><input type="text" value="0"/></td> <td>Ch05</td> <td><input type="text" value="0"/></td> <td>Ch04</td> </tr> <tr> <td><input type="text" value="0"/></td> <td>Ch03</td> <td><input type="text" value="0"/></td> <td>Ch02</td> <td><input type="text" value="0"/></td> <td>Ch01</td> <td><input type="text" value="0"/></td> <td>Ch00</td> </tr> </table>	<input type="text" value="0"/>	Ch07	<input type="text" value="0"/>	Ch06	<input type="text" value="0"/>	Ch05	<input type="text" value="0"/>	Ch04	<input type="text" value="0"/>	Ch03	<input type="text" value="0"/>	Ch02	<input type="text" value="0"/>	Ch01	<input type="text" value="0"/>	Ch00
<input type="text" value="0"/>	Ch07	<input type="text" value="0"/>	Ch06	<input type="text" value="0"/>	Ch05	<input type="text" value="0"/>	Ch04										
<input type="text" value="0"/>	Ch03	<input type="text" value="0"/>	Ch02	<input type="text" value="0"/>	Ch01	<input type="text" value="0"/>	Ch00										
Frequency Measurement (DI)																	
Enable Frequency Measurement	<input type="text" value="0x0"/> Ch 7~4(<input type="checkbox"/> <input type="checkbox"/> <input type="checkbox"/> <input type="checkbox"/>) Ch 3~0(<input type="checkbox"/> <input type="checkbox"/> <input type="checkbox"/> <input type="checkbox"/>)																
Scan Mode	<input type="text" value="Single pulse"/> 1000 ms: 1 Hz ~ 3.5 kHz (+/- 1 Hz error). 100 ms: 100 Hz to 3.5 kHz (+/- 10 Hz error). Single-pulse: 0.01 Hz ~ 1 Hz (+/- 0.01 Hz error), for stable signal only.																
Moving Average	<input type="text" value="1"/>																
Universal DIO																	
Force DI/DO Mode	<input type="text" value="Dynamic"/> Static: By configuration. Dynamic: Depends on DO requests. <input type="text" value="0xFF00"/> Ch 7~4(<input type="checkbox"/> <input type="checkbox"/> <input type="checkbox"/> <input type="checkbox"/>) Ch 3~0(<input type="checkbox"/> <input type="checkbox"/> <input type="checkbox"/> <input type="checkbox"/>) (0=DO, 1=DI; for ET-2254 Only)																
<input type="button" value="Update Settings"/>																	

The following table provides an overview of the parameters contained in the **DI/DO Configuration** section:

Item	Description
Digital Output	
Host Watchdog Timeout (Seconds)	This parameter is used to configure the Host Watchdog timeout value. If there is no Modbus TCP communication activity for the specified period (the timeout), then the Host Watchdog will activate an alarm.
Enable Watchdog	This parameter is used to enable the watchdog on each DO channels.
Safe Value	This parameter is used to define the DO safe value for the ET-2200 module. If the Host Watchdog alarm is activated, the DO will be set to the user-defined safe value.
Power-On Value	This parameter is used to define the DO Power-on value. On boot up, the DO is set to the user-defined Power-on value.
Digital Input	
Enable Latched DI	This parameter is uses to enable the latch function on all DI channels. The status of the DI will be recorded if it has been flagged as either high or low. 0 = Disable All; 1 = Enable All
Clear Latched Status (High)	This parameter is used to clear the status of all high latched D/I. 0 = No Operation; 1 = Clear All
Clear Latched Status (Low)	This parameter is used to clear the status of all low latched D/I. 0 = No Operation; 1= Clear All
DI Filter Level	The DI filter is a function that eliminates high-frequency noise from inputs. Settings range value: 1 ~ 6500 (ms); 0 = Disable (Default). Refer to “FAQ004 What is Digital-Input Filter (DI Filter)” for more detailed information.
Digital Counter	
Enable Digital Counter	This parameter is used to enable the digital counter on each DI channels.
Clear Digital Counter	This parameter is used to clear the values of each DI counters.
Preset Counter Value	This parameter is used to set the default value for each DI counters.
Frequency Measurement by DI	
Enable Frequency Measurement	This parameter is used to enable the frequency measurement function on each DI channels.

<p>Scan Mode</p>	<p>This parameter is used to define the scan mode for the frequency measurement.</p> <p>1000 ms: This mode provides a normal update rate and normal accuracy. The acceptable frequency range for the input signal is 1 Hz to 3 kHz (± 1 Hz error). This mode can be used when the pulse width (signal source) contains small errors, since the measurement is based on the pulse count.</p> <p>100 ms: This mode provides fast update rate, but the accuracy is low. The acceptable frequency range for the input signal is 100 Hz to 3 kHz (± 10 Hz error). This mode can be used when the pulse width (signal source) contains small errors, since the measurement is based on the pulse count.</p> <p>Single-pulse: This mode provides the highest accuracy but can only be used for stable signal. The data update rate depends on the signal frequency and the acceptable signal frequency range for the input signal is 0.01 Hz to 3.5 kHz (± 0.01 Hz error). This mode can only be used when the pulse width (signal source) is stable, since the measurement is based on the width of a single pulse.</p>
<p>Moving Average</p>	<p>1 ==> No Average is used 2 ==> Uses the average of 2 continuous sample values 4 ==> Uses the average of 4 continuous sample values 8 ==> Uses the average of 8 continuous sample values</p>
<p>Universal DIO</p>	
<p>Force DI/DO type <i>(For ET-2254 only)</i></p>	<p>Dynamic: Dynamic I/O type based on DO requests.</p> <p>Static: Static I/O type by configuration (web or Modbus). <input type="text" value="0x#00"/> Ch 7~4(<input type="checkbox"/> <input type="checkbox"/> <input type="checkbox"/> <input type="checkbox"/>) Ch 3~0(<input type="checkbox"/> <input type="checkbox"/> <input type="checkbox"/> <input type="checkbox"/>)</p> <p>This parameter is used to set the Universal DIO channels to DI or DO Port. 1 ==> DI; 0 ==> DO</p>
<p>Update Settings</p>	<p>Click this button to save the revised settings of DI/DO configuration to the ET-2200 module.</p>

4.5 Sync



ET-2200 Series Ethernet I/O Module

Home | Network | I/O Settings | **Sync** | PWM | Pair | Filter | Monitor | Change Password | Logout

Model Name:	ET-2255	Alias Name:	EtherIO
Firmware Version:	v1.3.9 [Jan.29, 2016]	MAC Address:	00-0d-e0-ff-ff-ff
IP Address:	10.0.8.7	Initial Switch:	ON
TCP Port Timeout (Socket Watchdog, Seconds):	180	System Timeout (Network Watchdog, Seconds)	0

Clicking the **Sync** tab will display the **DIO Synchronization** page allowing you configure the Synchronous DIO, Min-switching time of DO and Auto-off Time of DO for the ET-2200 series module, each of which will be described in more detail below.

4.5.1 DIO Synchronization

DIO Synchronization

Synchronous DIO (Local Mirror)	
Level Sync (DO=DI)	<input type="text" value="0x0"/> CH7-CH4: <input type="checkbox"/> <input type="checkbox"/> <input type="checkbox"/> <input type="checkbox"/> CH3-CH0: <input type="checkbox"/> <input type="checkbox"/> <input type="checkbox"/> <input type="checkbox"/> Set the DO state to the same as the DI state.
Rising Active (DO=ON)	<input type="text" value="0x0"/> CH7-CH4: <input type="checkbox"/> <input type="checkbox"/> <input type="checkbox"/> <input type="checkbox"/> CH3-CH0: <input type="checkbox"/> <input type="checkbox"/> <input type="checkbox"/> <input type="checkbox"/> Turn ON DO when DI is changed from OFF to ON.
Falling Active (DO=ON)	<input type="text" value="0x0"/> CH7-CH4: <input type="checkbox"/> <input type="checkbox"/> <input type="checkbox"/> <input type="checkbox"/> CH3-CH0: <input type="checkbox"/> <input type="checkbox"/> <input type="checkbox"/> <input type="checkbox"/> Turn ON DO when DI is changed from ON to OFF.
Additional Controls	
Min-Switching Time of DO (0 to 65535 Seconds)	DO 00:0 <input type="text"/> DO 01:0 <input type="text"/> DO 02:0 <input type="text"/> DO 03:0 <input type="text"/>
	DO 04:0 <input type="text"/> DO 05:0 <input type="text"/> DO 06:0 <input type="text"/> DO 07:0 <input type="text"/>
	DO 08:0 <input type="text"/> DO 09:0 <input type="text"/> DO 10:0 <input type="text"/> DO 11:0 <input type="text"/>
	DO 12:0 <input type="text"/> DO 13:0 <input type="text"/> DO 14:0 <input type="text"/> DO 15:0 <input type="text"/>
Auto-off Time of DO (0 to 65535 Seconds)	DO 00:0 <input type="text"/> DO 01:0 <input type="text"/> DO 02:0 <input type="text"/> DO 03:0 <input type="text"/>
	DO 04:0 <input type="text"/> DO 05:0 <input type="text"/> DO 06:0 <input type="text"/> DO 07:0 <input type="text"/>
	DO 08:0 <input type="text"/> DO 09:0 <input type="text"/> DO 10:0 <input type="text"/> DO 11:0 <input type="text"/>
	DO 12:0 <input type="text"/> DO 13:0 <input type="text"/> DO 14:0 <input type="text"/> DO 15:0 <input type="text"/>
<input type="button" value="Update Settings"/>	

The following table provides an overview of the parameters contained in the **DIO Synchronization** section:

Item	Description
Synchronous DIO (Local Mirror) Note: The ET-2254 supports these functions when low 8-bit are DI0 to DI7 and high 8-bit are DO8 to DO15.	
Level Sync (DO = DI)	This parameter is used to enable the synchronization operation in Digital Input/Output function.
Rising Active (DO = ON)	This parameter is used to enable rising active in Digital Input function. When the specified DI state changed from OFF to ON, the corresponding DO will be set to ON.
Falling Active (DO = ON)	This parameter is used to enable falling active in Digital Input function. When the specified DI state changed from ON to OFF, the corresponding DO will be set to ON.
Additional Controls	
Min-Switch Time of DO (0 to 65535 Seconds)	This parameter is used to set the minimum switching time between the ON and OFF state of the Digital Output. This protects some machines from being damaged by too many ON/OFF switches in a short time.
Auto-off Time of DO (0 to 65535 Seconds)	This parameter is used to set the auto-off time of the Digital Output. If the Digital Output is ON, the Digital Output will be auto-off based on the configured time value.
Update Settings	Click this button to save the revised settings of DIO configuration to the ET-2200 module.

4.6 PWM



ET-2200 Series Ethernet I/O Module

Home | Network | I/O Settings | Sync | **PWM** | Pair | Filter | Monitor | Change Password | Logout

Model Name:	ET-2255	Alias Name:	EtherIO
Firmware Version:	v1.3.9 [Jan.29, 2016]	MAC Address:	00-0d-e0-ff-ff-ff
IP Address:	10.0.8.7	Initial Switch:	ON
TCP Port Timeout (Socket Watchdog, Seconds):	180	System Timeout (Network Watchdog, Seconds)	0

Clicking the **PWM** tab will display the **PWM Configuration** page allowing you enable and configure the PWM parameters for the ET-2200 series module, including the PWM Alarm and duty cycle, etc., each of which will be described in more detail below.

4.6.1 PWM Configuration

PWM Configuration:

Enable PWM	<input type="checkbox"/> 0x0	Ch 7~4(<input type="checkbox"/> <input type="checkbox"/> <input type="checkbox"/> <input type="checkbox"/>) Ch 3~0(<input type="checkbox"/> <input type="checkbox"/> <input type="checkbox"/> <input type="checkbox"/>)
Enable PWM Alarm	<input type="checkbox"/> 0x0	Ch 7~4(<input type="checkbox"/> <input type="checkbox"/> <input type="checkbox"/> <input type="checkbox"/>) Ch 3~0(<input type="checkbox"/> <input type="checkbox"/> <input type="checkbox"/> <input type="checkbox"/>) (When Host/Slave Watchdog Timeout)
Duty Cycle	(<input type="text" value="1000"/> , <input type="text" value="1000"/>)	}DO0 (<input type="text" value="1000"/> , <input type="text" value="1000"/>)}DO1 (<input type="text" value="1000"/> , <input type="text" value="1000"/>)}DO2 (<input type="text" value="1000"/> , <input type="text" value="1000"/>)}DO3 (<input type="text" value="1000"/> , <input type="text" value="1000"/>)}DO4 (<input type="text" value="1000"/> , <input type="text" value="1000"/>)}DO5 (<input type="text" value="1000"/> , <input type="text" value="1000"/>)}DO6 (<input type="text" value="1000"/> , <input type="text" value="1000"/>)}DO7 (High, Low: 10 ~ 65535 ms, 0= Disable)
<input type="button" value="Update Settings"/>		

The following table provides an overview of the parameters contained in the **PWM Configuration** section:

Item	Description	Default Value
Enable PWM	This parameter is used to enable the PWM output function.	0
Enable PWM Alarm	This parameter is used to enable the PWM output alarm function when Host/Slave watchdog timeout.	0
Duty Cycle	This parameter is used to set the duty cycle for the DO channels. Two values are required for each DO channel. The first value is the high pulse width, while the second is the low pulse width. The duty cycle is in 1 ms units, and the resolution is approximately 5 ms. (10 to 65535 ms). A value of 0 will disable the duty cycle functions for that channel.	1000 (ms)
Update Settings	Click this button to save the revised settings to the ET-2200 module.	

 **Note:** Because of the characteristics of the relay functions, it is recommended that the PWM on ET-2260/2261/2268 module (i.e., modules with relay functions) is not used for extended periods of time.

4.7 Pair Connection



ET-2200 Series Ethernet I/O Module

Home | Network | I/O Settings | Sync | **Pair** | Filter | Monitor | Change Password | Logout

Model Name:	ET-2255	Alias Name:	EtherIO
Firmware Version:	v1.3.9 [Jan.29, 2016]	MAC Address:	00-0d-e0-ff-ff-ff
IP Address:	10.0.8.7	Initial Switch:	ON
TCP Port Timeout (Socket Watchdog, Seconds):	180	System Timeout (Network Watchdog, Seconds):	0

Clicking the **Pair** tab will display the **I/O Pair Connection Settings** page allowing you enable and configure the DI-to-DO pair connections for the ET-2200 series module, which will be described in more detail below.

4.7.1 I/O Pair-Connection Settings

The I/O pair connection function is a specific feature of the ET-2200 series module that can be used to enable a pair of DI-to-DO connections via the Modbus TCP (Ethernet) protocol.

I/O Pair-Connection Settings:

POLL Mode: (Remote DI -> Local DO)

PUSH Mode: (Local DI -> Remote DO)

Function in "BLUE" text available in "PUSH" Mode Only

| 1~5 | 6~10 | 11~12 |

#	Mode	Remote IP	Remote Port	Net ID	Scan Time	DI Count	DI Addr	DO Addr	TCP/UDP	Update
01	Disable	0 0 0 0	502	1	1000 ms	0	0	0	TCP	Submit
02	Disable	0 0 0 0	502	1	1000 ms	0	0	0	TCP	Submit
03	Disable	0 0 0 0	502	1	1000 ms	0	0	0	TCP	Submit
04	Disable	0 0 0 0	502	1	1000 ms	0	0	0	TCP	Submit
05	Disable	0 0 0 0	502	1	1000 ms	0	0	0	TCP	Submit

The following table provides an overview of the parameters contained in the **I/O Pair-Connection Settings** section:

Item	Description	Default
Mode	<p>This parameter is used to define the Server mode for the ET-2200 series module.</p> <p>Mode = Disable: Server mode (Slave).</p> <p>Mode = POLL: Poll remote DI to local DO in the Client mode (Master).</p> <p>Mode = PUSH: Push local DI to remote DO in the Client mode (Master).</p> <p>The DI Count field must also be configured to enable Client mode.</p>	Disable
Remote IP	The IP address of the remote device to access.	0
Remote Port	The TCP port number of the remote device to access. Range: 0 to 65535.	502
Net ID	The Modbus Net ID of the remote device to access. Range: 1 to 247.	1
Scan Time	<p>For "POLL" mode, the module will update the DI/DO states based on the time period of the Scan Time parameter.</p> <p>For "PUSH" mode, the module will update remote DO state when the local DI state is changed. The module will also force update remote DO when the local DI is no change during the time period of the Scan Time parameter.</p> <p>Range: 1000 to 42949672965 ms.</p>	1000 ms
DI Count	<p>This parameter specifies how many digital I/O channels are mapped.</p> <p>Range: 1 to 16; 0= Disable.</p>	0
DI Addr	<p>For "POLL" mode, this parameter specifies the base address of the Remote DI device that will be mapped to the Local DO register. The range depends on the type of remote device being used.</p> <p>For "PUSH" mode, this parameter specifies the base address of the Local DI register that will be mapped to the Remote DO device. The range depends on the type of ET-2200 module being used.</p>	0

DO Addr	<p>For “POLL” mode, this parameter specifies the base address of the Local DO register that will be mapped to the Remote DI device. The range depends on the type of the ET-2200 module being used.</p> <p>For “PUSH” mode, this parameter specifies the base address of the Remote DO device that will be mapped to the Local DI register. The range depends on the type of remote device being used.</p>	0
TCP/UDP	<p>This parameter is used to set the type of Modbus protocol to be used and can be either TCP or UDP for the “PUSH” mode only.</p>	TCP
Update	<p>Click “Submit” button to save the revised settings to the ET-2200 module.</p>	

4.8 Filter



ET-2200 Series Ethernet I/O Module

Home | Network | I/O Settings | Sync | PWM | Par | **Filter** | Monitor | Change Password | Logout

Model Name:	ET-2255	Alias Name:	EtherIO
Firmware Version:	v1.3.9 [Jan.29, 2016]	MAC Address:	00-0d-e0-ff-ff-ff
IP Address:	10.0.8.7	Initial Switch:	ON
TCP Port Timeout (Socket Watchdog, Seconds):	180	System Timeout (Network Watchdog, Seconds)	0

Clicking the **Filter** tab will display the **Filter Settings** page allowing you configure the IP Filter list for the ET-2200 series module, which will be described in more detail below.

4.8.1 Filter Settings

The **Filter Settings** page is used to query or edit the IP Filter List (Available IP) for the ET-2200 series module. The IP filter list restricts the access of incoming packets based on the IP address. If one or more IP addresses are saved to the IP Filter table, only Clients whose IP address is specified in the IP Filter List (Available IP) will be able to access the ET-2200 series module.

Filter Settings:

Available IP List	IP Address
IP1:	10.0.8.20
IP2:	0.0.0.0
IP3:	0.0.0.0
IP4:	0.0.0.0
IP5:	0.0.0.0

Add . . . To The List
 Delete IP#
 Delete ALL
 Save to Flash

The following table provides an overview of the parameters contained in the IP Address Configuration section:

Item	Description
Add "IP" to the List	This parameter is used to add an IP address to the Available IP List.
Delete IP # "number"	This parameter is used to delete IP# address from the Available IP List.
Delete All	This parameter is used to delete all IP address current contained in the Available IP List.
Save to Flash	This parameter is used to save the updated Available IP List to the Flash memory. Check the checkbox before clicking the Submit button of you wish to store the most recent list.
Submit	Click this button to save the revised settings to ET-2200 module.

4.9 Monitor



ET-2200 Series Ethernet I/O Module

[Home](#) | [Network](#) | [I/O Settings](#) | [Sync](#) | [PWM](#) | [Pair](#) | [Filter](#) | **[Monitor](#)** | [Change Password](#) | [Logout](#)



After clicking the **Monitor** tab, the Current Connection Status page will be displayed showing detailed information regarding the current status of the serial port connection settings for the ET-2200 series module.

Current Connection Status:

Server Mode	Server
Connected IP1:	0.0.0.0
IP2:	0.0.0.0
IP3:	0.0.0.0
IP4:	0.0.0.0
IP5:	0.0.0.0
IP6:	0.0.0.0
Available Connections:	32

4.10 Change Password



ET-2200 Series Ethernet I/O Module

[Home](#) | [Network](#) | [I/O Settings](#) | [Sync](#) | [PWM](#) | [Pair](#) | [Filter](#) | [Monitor](#) | **[Change Password](#)** | [Logout](#)



After clicking the **Password** tab, the **Change Password** page will be displayed. To change a password, first enter the old password in the **“Current password”** field (use the default password **“Admin”**) and then enter a new password in the **“New password”** field. Re-enter the new password in the **“Confirm new password”** field, and then click the **“Submit”** button to update the password.

Change Password

The length of the password is 12 characters maximum.

Current password:	<input type="password" value="....."/>
New password:	<input type="password" value="...."/>
Confirm new password:	<input type="password" value="...."/>
	<input type="button" value="Submit"/>

4.11 Logout



ET-2200 Series Ethernet I/O Module

[Home](#) | [Network](#) | [I/O Settings](#) | [Sync](#) | [PWM](#) | [Pair](#) | [Filter](#) | [Monitor](#) | [Change Password](#) | [Logout](#)



Clicking the **Logout** tab will immediately log you out from the system and return you to the login page.

The system is logged out.

To enter the web configuration, please type password in the following field.

Login password:

Note: This web configuration requires JavaScript enabled in your browser (Firefox, IE...).
If the web configuration does not work, please check the JavaScript settings first.

When using IE, please disable its cache as follows.

Menu items: Tools / Internet Options... / General / Temporary Internet Files / Settings... / Every visit to the page

5. I/O Pair Connection Applications

The ET-2200 series modules can be used to create DI-to-DO pair connections via the Ethernet. Once the configuration is complete, the modules can then poll the status of the local DI channels and then use the Modbus/TCP protocol to continuously write to a remote DO device in the background. This is useful when connecting Digital I/O devices that do not themselves have Ethernet capability. The following will describe how to correctly configure the I/O pair connection function.

5.1 One Module Polling the Remote DI/DO (1-to-1, Polling Mode)

Step 1: Connect the device to a Network, a PC and a Power supply.

Confirm that the ET-2200 series modules are functioning correctly. Refer to [Chapter 3 “Getting Started”](#) for more details. An example configuration shown below:

Note that ET-2260 module is used in this example.

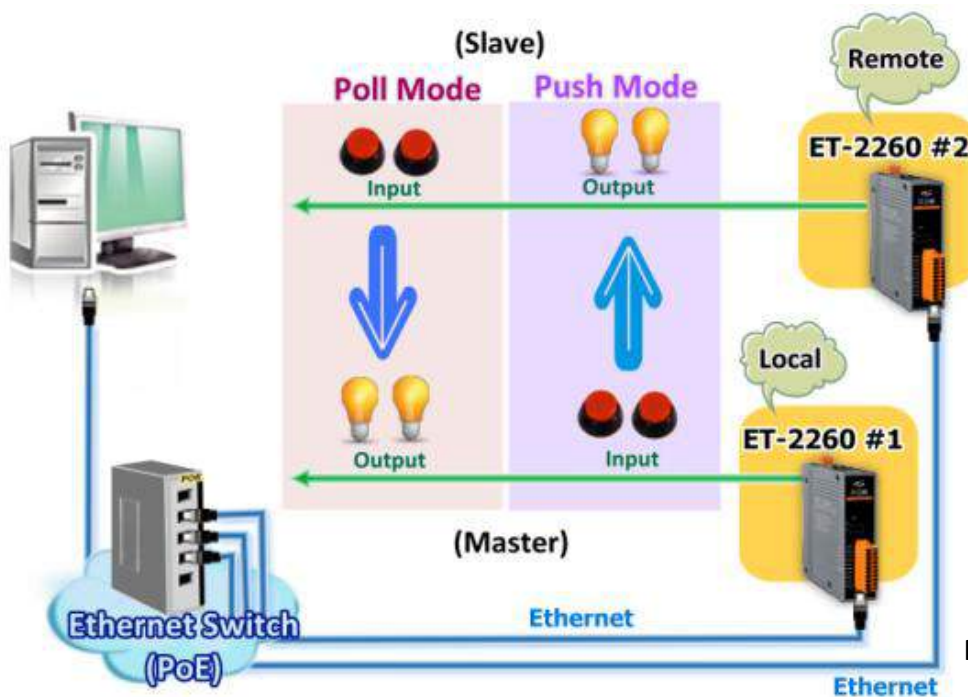

Figure 5-1.1

Step 2: Configure the Ethernet Settings

Contact your Network Administrator to obtain the correct network configuration information for the ET-2200 series modules (e.g., ET-2260 #1 and #2), such as the IP Address, Subnet Mask, and Gateway details. Refer to [Section 3.3 “Configuring the Network Settings”](#) for more details.

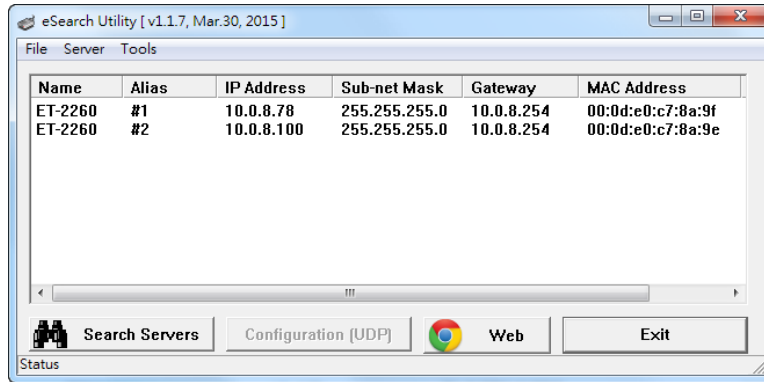

Figure 5-1.2

Step 3: Configure the I/O Pair connection on the Web Server

1. In the eSearch Utility, select **ET-2260 #1 module** and then click the **“Web”** button to launch the browser program and connect to the web server.
2. Enter the password in the Login password field (**the default password is “Admin”**), and then click the **“Submit”** button to display the configuration page.

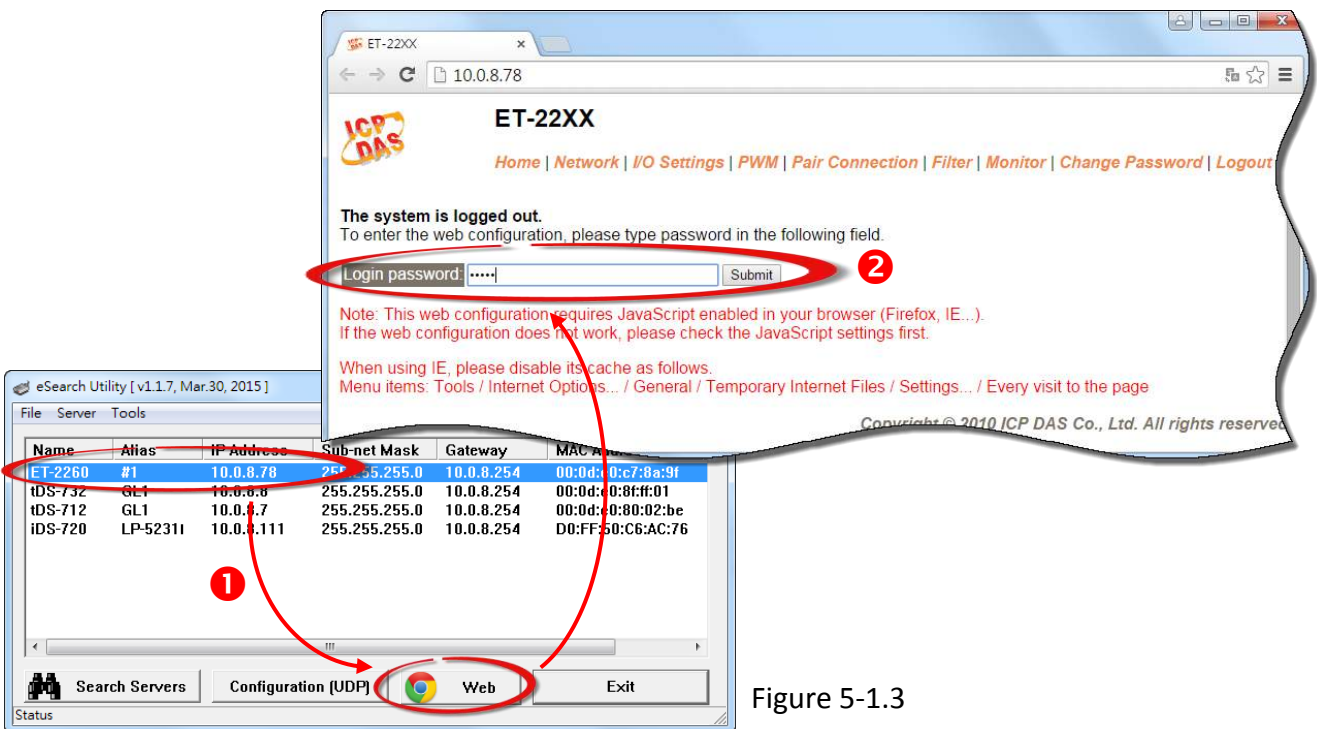

Figure 5-1.3

- Click the **“Pair Connection”** tab to display the I/O Pair-connection Settings page.

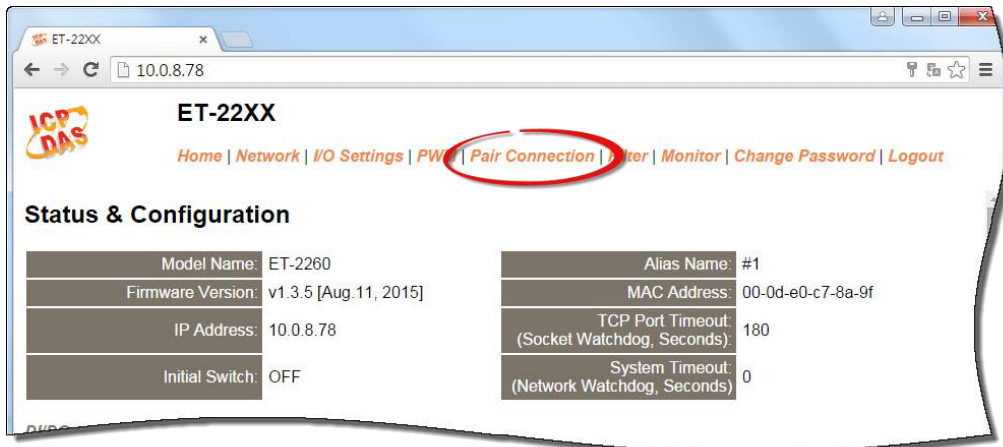

Figure 5-1.4

5.1.1 Polling Mode

- In the “I/O Pair-connection Settings”, select **“POLL”** from the **“Mode”** drop-down options.
- Enter the **IP address for ET-2260 #2 module** in the **“Remote IP”** field.
- Enter the **TCP Port for ET-2260 #2 module** in the **“Remote Port”** field.
- Enter a **DI Count Value for ET-2260 #2 module** in the **“DI Count”** field (Remote DI to Local DO).

The following is an example of a **Polling mode** configuration:
 Enter **“2”** in the **“DI Count”** field. This means **DI x2 of ET-2260 #2 module** is mapped to **DO x2 of ET-2260 #1 module**.

- Click the **“Submit”** button to complete the configuration.

I/O Pair-Connection Settings:

POLL Mode: (Remote DI -> Local DO)

PUSH Mode: (Local DI -> Remote DO)

Function in "BLUE" text available in "PUSH" Mode Only

| 1~5 | 6~10 | 11~12 |

#	Mode	Remote IP	Remote Port	Net ID	Scan Time	DI Count	DI Addr	DO Addr	TCP/UDP	Update
01	POLL	10 0 8 100	502	1	1000 ms	2	0	0	TCP	Submit
02	Disable	0 0 0 0	502	1	1000 ms	0	0	0	TCP	Submit
03	Disable	0 0 0 0	502	1	1000 ms	0	0	0	TCP	Submit
04	Disable	0 0 0 0	502	1	1000 ms	0	0	0	TCP	Submit
05	Disable	0 0 0 0	502	1	1000 ms	0	0	0	TCP	Submit

Figure 5-1.5

5.1.2 Push Mode

4. In the “I/O Pair-connection Settings”, select “**PUSH**” from the “**Mode**” drop-down options.
5. Enter the **IP address for ET-2260 #2 module** in the “**Remote IP**” field.
6. Enter the **TCP Port for ET-2260 #2 module** in the “**Remote Port**” field.
7. Enter a **DI Count Value for ET-2260 #1 module** in the “**DI Count**” field (Local DI to Remote DO).

The following is an example of a **Push mode** configuration:

Enter “**2**” in the “**DI Count**” field. This means **DI x2 of ET-2260 #1 module** is mapped to **DO x2 of ET-2260 #2 module**.

8. Select **Modbus protocol (e.g., “TCP”)** from the “**TCP/UDP**” drop-down options.
9. Click the “**Submit**” button to complete the configuration.

I/O Pair-Connection Settings:

POLL Mode: (Remote DI -> Local DO)

PUSH Mode: (Local DI -> Remote DO)

Function in "BLUE" text available in "PUSH" Mode Only

| 1~5 | 6~10 | 11~12 |

#	Mode	Remote IP				Remote Port	Net ID	Scan Time	DI Count	DI Addr	DO Addr	TCP/UDP	Update
01	POLL	10	0	8	100	502	1	1000 ms	2	0	0	TCP	Submit
02	PUSH	10	0	8	100	502	1	1000 ms	2	0	0	TCP	Submit
03	Disable	0	0	0	0	502	1	1000 ms	0	0	0	TCP	Submit
04	Disable	0	0	0	0	502	1	1000 ms	0	0	0	TCP	Submit
05	Disable	0	0	0	0	502	1	1000 ms	0	0	0	TCP	Submit

Figure 5-1.6

5.2 Two Modules Pushing the Local DI to each other (1-to-1, Push Mode)

Step 1: Connect the device to a Network, a PC and a Power supply.

Confirm that the ET-2200 series modules are functioning correctly. Refer to [Chapter 3 “Getting Started”](#) for more details. An example configuration shown below:

Note that ET-2260 module is used in this example.

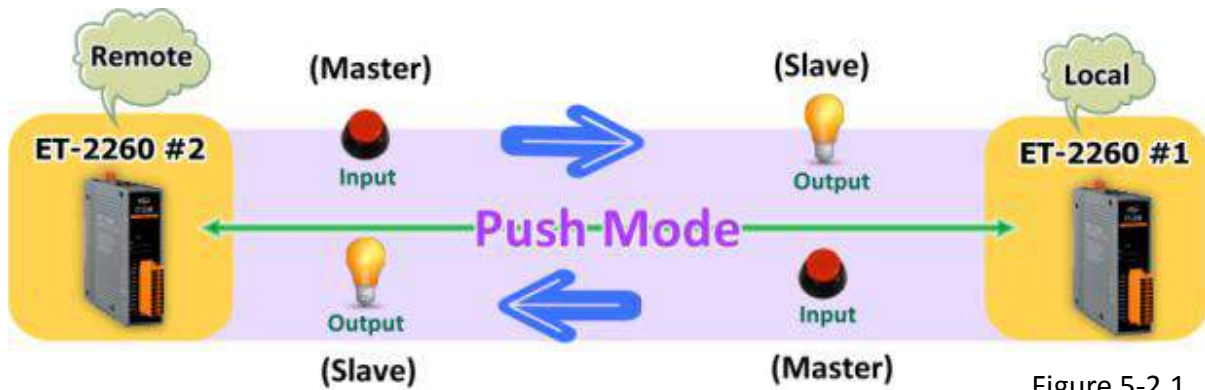

Figure 5-2.1

Step 2: Configure the Ethernet Settings

Contact your Network Administrator to obtain the correct network configuration information for the ET-2200 series modules (e.g., ET-2260 #1 and #2), such as the IP Address, Subnet Mask, and Gateway details. Refer to [Section 3.3 “Configuring the Network Settings”](#) for more details.

Name	Alias	IP Address	Sub-net Mask	Gateway	MAC Address
ET-2260	#1	10.0.8.78	255.255.255.0	10.0.8.254	00:0d:e0:c7:8a:9f
ET-2260	#2	10.0.8.100	255.255.255.0	10.0.8.254	00:0d:e0:c7:8a:9e

Figure 5-2.2

Step 3: Configure the I/O Pair connection on the ET-2260 #1 module

1. In the eSearch Utility, select **ET-2260 #1 module** and then click the **“Web”** button to launch the browser program and connect to the web server.
2. Enter the password in the Login password field (**the default password is “Admin”**), and then click the **“Submit”** button to display the configuration page.
3. Click the **“Pair Connection”** tab to display the I/O Pair-connection Settings page.

Refer to [Figures 5-1.3 to 5-1.4](#) for illustrations of how to perform the above procedure.

4. In the “I/O Pair-connection Settings”, select **“PUSH”** from the **“Mode”** drop-down options.
5. Enter the **IP address for ET-2260 #2 module** in the **“Remote IP”** field.
6. Enter the **TCP Port for ET-2260 #2 module** in the **“Remote Port”** field.
7. Enter a **DI Count Value for ET-2260 #1 module** in the **“DI Count”** field (Local DI to Remote DO).

For example, enter **“1”** in the **“DI Count”** field. This means **DI x1 of ET-2260 #1 module** is mapped to **DO1 x of ET-2260 #2 module**.

8. Select **Modbus protocol (e.g., “TCP”)** from the **“TCP/UDP”** drop-down options.
9. Click the **“Submit”** button to complete the configuration.

I/O Pair-Connection Settings: Figure 5-2.3

POLL Mode: (Remote DI -> Local DO)

PUSH Mode: (Local DI -> Remote DO)

Function in "BLUE" text available in "PUSH" Mode Only

| 1~5 | 6~10 | 11~12 |

#	Mode	Remote IP				Remote Port	Net ID	Scan Time	DI Count	DI Addr	DO Addr	TCP/UDP	Update
01	PUSH	10	0	8	100	502	1	1000 ms	1	0	0	TCP	Submit
02	Disable	0	0	0	0	502	1	1000 ms	0	0	0	TCP	Submit
03	Disable	0	0	0	0	502	1	1000 ms	0	0	0	TCP	Submit
04	Disable	0	0	0	0	502	1	1000 ms	0	0	0	TCP	Submit
05	Disable	0	0	0	0	502	1	1000 ms	0	0	0	TCP	Submit

Step 4: Configure the I/O Pair connection on the ET-2260 #2 module

1. In the eSearch Utility, select **ET-2260 #2 module** and then click the **“Web”** button to launch the browser program and connect to the web server.
2. Enter the password in the Login password field (**the default password is “Admin”**), and then click the **“Submit”** button to display the configuration page.
3. Click the **“Pair Connection”** tab to display the I/O Pair-connection Settings page.

Refer to [Figures 5-1.3 to 5-1.4](#) for illustrations of how to perform the above procedure.

4. In the “I/O Pair-connection Settings”, select **“PUSH”** from the **“Mode”** drop-down options.
5. Enter the **IP address for ET-2260 #1 module** in the **“Remote IP”** field.
6. Enter the **TCP Port for ET-2260 #1 module** in the **“Remote Port”** field.
7. Enter a **DI Count Value for ET-2260 #2 module** in the **“DI Count”** field (Local DI to Remote DO).

For example, enter **“1”** in the **“DI Count”** field. This means **DI x1 of ET-2260 #2 module** is mapped to **DO1 x of ET-2260 #1 module**.

8. Select **Modbus protocol (e.g., “TCP”)** from the **“TCP/UDP”** drop-down options.
9. Click the **“Submit”** button to complete the configuration.

I/O Pair-Connection Settings: Figure 5-2.4

POLL Mode: (Remote DI -> Local DO)

PUSH Mode: (Local DI -> Remote DO)

Function in "BLUE" text available in "PUSH" Mode Only

| 1~5 | 6~10 | 11~12 |

#	Mode	Remote IP	Remote Port	Net ID	Scan Time	DI Count	DI Addr	DO Addr	TCP/UDP	Update
01	PUSH ▼	10 0 8 78	502	1	1000 ms	1	0	0	TCP ▼	Submit
02	Disable ▼	0 0 0 0	502	1	1000 ms	0	0	0	TCP ▼	Submit
03	Disable ▼	0 0 0 0	502	1	1000 ms	0	0	0	TCP ▼	Submit
04	Disable ▼	0 0 0 0	502	1	1000 ms	0	0	0	TCP ▼	Submit
05	Disable ▼	0 0 0 0	502	1	1000 ms	0	0	0	TCP ▼	Submit

5.3 Several Modules Polling the Remote DI (M-to-1) (Polling Mode)

Step 1: Connect the device to a Network, a PC and a Power supply.

Confirm that the ET-2200 series modules and remote slave device are functioning correctly. Refer to [Chapter 3 “Getting Started”](#) for more details. An example configuration shown below:

Note that ET-2260 and PETL-7060 module is used in this example.

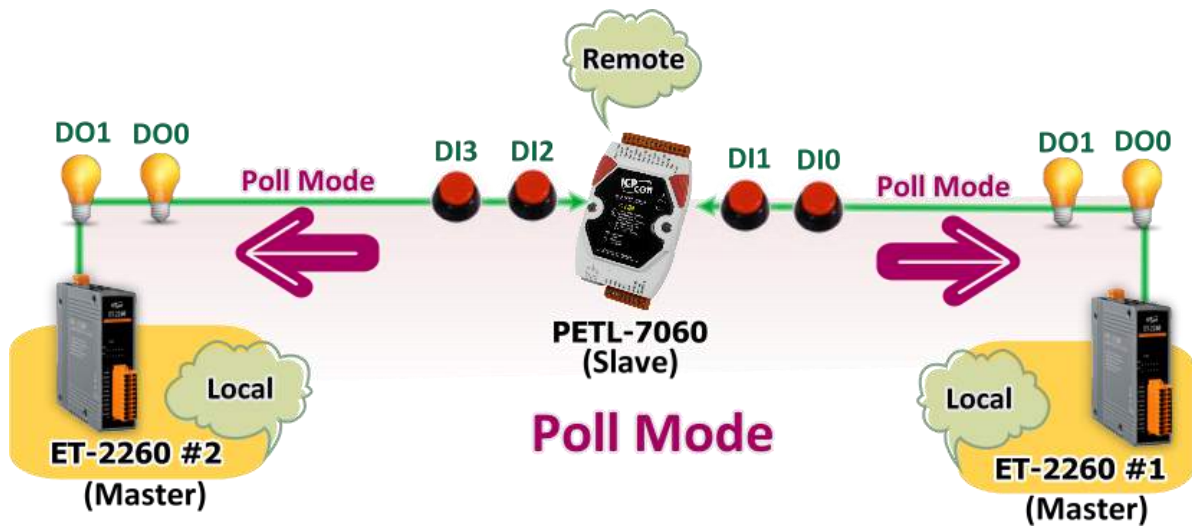

Figure 5-3.1

Step 2: Configure the Ethernet Settings

Contact your Network Administrator to obtain the correct network configuration information for the ET-2200 series modules and remote slave device (e.g., ET-2260 #1, #2 and PETL-7060), such as the IP Address, Subnet Mask, and Gateway details. Refer to [Section 3.3 “Configuring the Network Settings”](#) for more details.

Name	Alias	IP Address	Sub-net Mask	Gateway	MAC Address
PETL-7060	EtherIO	10.0.8.55	255.255.255.0	10.0.8.254	00:0d:e0:60:01:68
ET-2260 #1		10.0.8.78	255.255.255.0	10.0.8.254	00:0d:e0:c7:8a:9f
ET-2260 #2		10.0.8.100	255.255.255.0	10.0.8.254	00:0d:e0:c7:8a:9e

The screenshot shows the eSearch Utility interface with a table of network configurations. Below the table are buttons for 'Search Servers', 'Configuration [UDP]', 'Web', and 'Exit'. The status bar at the bottom indicates 'Status'.

Figure 5-3.2

Step 3: Configure the I/O Pair connection on the ET-2260 #1 module

1. In the eSearch Utility, select **ET-2260 #1 module** and then click the **“Web”** button to launch the browser program and connect to the web server.
2. Enter the password in the Login password field (**the default password is “Admin”**), and then click the **“Submit”** button to display the configuration page.
3. Click the **“Pair Connection”** tab to display the I/O Pair-connection Settings page.

Refer to [Figures 5-1.3 to 5-1.4](#) for illustrations of how to perform the above procedure.

4. In the “I/O Pair-connection Settings”, select **“POLL”** from the **“Mode”** drop-down options.
5. Enter the **IP address for remote slave device (e.g., PETL-7060)** in the **“Remote IP”** field.
6. Enter the **TCP Port for remote slave device (e.g., PETL-7060)** in the **“Remote Port”** field.
7. Enter a **DI Count Value for remote slave device (e.g., PETL-7060)** in the **“DI Count”** field (Remote DI to Local DO).

For example, enter **“2”** in the **“DI Count”** field. This means **DI x2 of the PETL-7060 module is mapped to DO x2 of ET-2260 #1 module.**

8. Enter the **DI address for remote slave device (e.g., PETL-7060)** in the **“DI Addr”** field (Remote DI to Local DO).

For example, enter **“0”** in the **“DI Addr”** field. This means **DI addresses DI0 and DI1 of the PETL-7060 module are mapped to DO x2 of ET-2260 #1 module.**

9. Click the **“Submit”** button to complete the configuration.

I/O Pair-Connection Settings:

Figure 5-3.3

POLL Mode: (Remote DI -> Local DO)

PUSH Mode: (Local DI -> Remote DO)

Function in "BLUE" text available in "PUSH" Mode Only

| 1~5 | 6~10 | 11~12 |

#	Mode	Remote IP	Remote Port	Net ID	Scan Time	DI Count	DI Addr	DO Addr	TCP/UDP	Update
01	POLL	10 0 8 55	502	1	1000 ms	2	0	0	TCP	Submit
02	Disable	0 0 0 0	502	1	1000 ms	0	0	0	TCP	Submit
03	Disable	0 0 0 0	502	1	1000 ms	0	0	0	TCP	Submit
04	Disable	0 0 0 0	502	1	1000 ms	0	0	0	TCP	Submit
05	Disable	0 0 0 0	502	1	1000 ms	0	0	0	TCP	Submit

Step 4: Configure the I/O Pair connection on the ET-2260 #2 module

1. In the eSearch Utility, select **ET-2260 #2 module** and then click the **“Web”** button to launch the browser program and connect to the web server.
2. Enter the password in the Login password field (**the default password is “Admin”**), and then click the **“Submit”** button to display the configuration page.
3. Click the **“Pair Connection”** tab to display the I/O Pair-connection Settings page.

Refer to [Figures 5-1.3 to 5-1.4](#) for illustrations of how to perform the above procedure.

4. In the “I/O Pair-connection Settings”, select **“POLL”** from the **“Mode”** drop-down options.
5. Enter the **IP address for remote slave device (e.g., PETL-7060)** in the **“Remote IP”** field.
6. Enter the **TCP Port for remote slave device (e.g., PETL-7060)** in the **“Remote Port”** field.
7. Enter a **DI Count Value for remote slave device (e.g., PETL-7060)** in the **“DI Count”** field (Remote DI to Local DO).

For example, enter **“2”** in the **“DI Count”** field. This means **DI x2 of the PETL-7060 module is mapped to DO x2 of ET-2260 #2 module.**

8. Enter the **DI address for remote slave device (e.g., PETL-7060)** in the **“DI Addr”** field (Remote DI to Local DO).

For example, enter **“2”** in the **“DI Addr”** field. This means **DI addresses DI2 and DI3 of the PETL-7060 module are mapped to DO x2 of ET-2260 #2 module.**

9. Click the **“Submit”** button to complete the configuration.

I/O Pair-Connection Settings:

Figure 5-3.4

POLL Mode: (Remote DI -> Local DO)

PUSH Mode: (Local DI -> Remote DO)

Function in "BLUE" text available in "PUSH" Mode Only

| 1~5 | 6~10 | 11~12 |

#	Mode	Remote IP				Remote Port	Net ID	Scan Time	DI Count	DI Addr	DO Addr	TCP/UDP	Update
01	POLL	10	0	8	55	502	1	1000 ms	2	2	0	TCP	Submit
02	Disable	0	0	0	0	502	1	1000 ms	0	0	0	TCP	Submit
03	Disable	0	0	0	0	502	1	1000 ms	0	0	0	TCP	Submit
04	Disable	0	0	0	0	502	1	1000 ms	0	0	0	TCP	Submit
05	Disable	0	0	0	0	502	1	1000 ms	0	0	0	TCP	Submit

5.4 Several Modules Pushing the Local DI (M-to-1) (Push Mode)

Step 1: Connect the device to a Network, a PC and a Power supply.

Confirm that the ET-2200 series modules and remote slave device are functioning correctly. Refer to [Chapter 3 “Getting Started”](#) for more details. An example configuration shown below:

Note that ET-2260 and PETL-7060 module is used in this example.

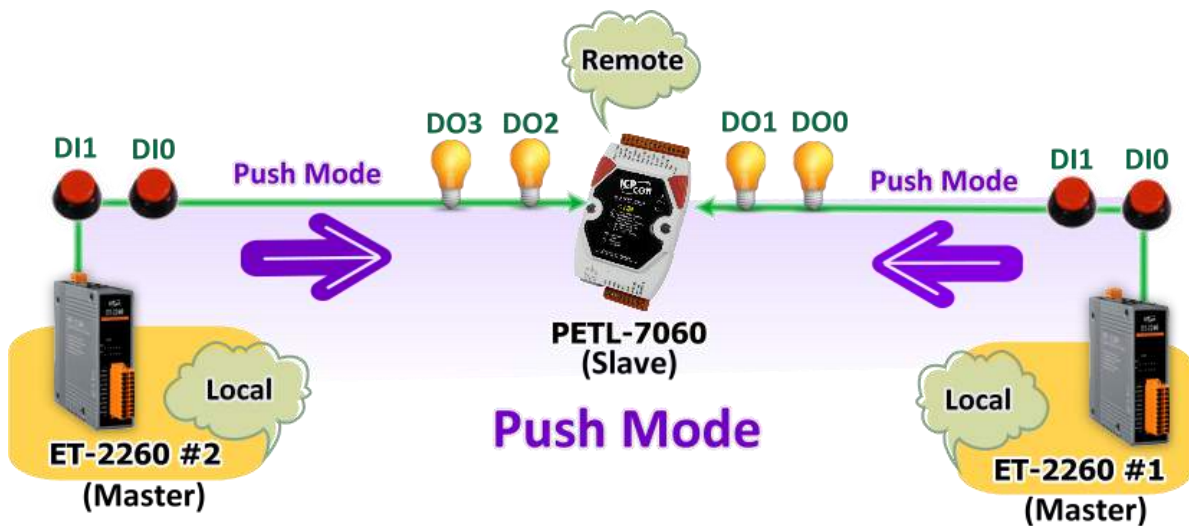

Figure 5-4.1

Step 2: Configure the Ethernet Settings

Contact your Network Administrator to obtain the correct network configuration information for the ET-2200 series modules and remote slave device (e.g., ET-2260 #1, #2 and PETL-7060), such as the IP Address, Subnet Mask, and Gateway details. Refer to [Section 3.3 “Configuring the Network Settings”](#) for more details.

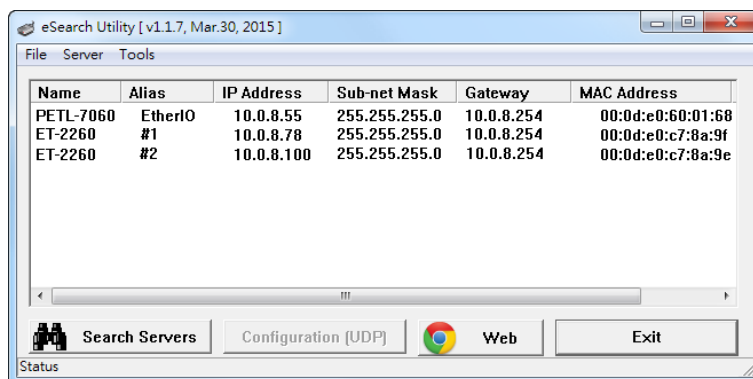

Figure 5-4.2

Step 3: Configure the I/O Pair connection on the ET-2260 #1 module

1. In the eSearch Utility, select **ET-2260 #1 module** and then click the **“Web”** button to launch the browser program and connect to the web server.
2. Enter the password in the Login password field (**the default password is “Admin”**), and then click the **“Submit”** button to display the configuration page.
3. Click the **“Pair Connection”** tab to display the I/O Pair-connection Settings page.

Refer to [Figures 5-1.3 to 5-1.4](#) for illustrations of how to perform the above procedure.

4. In the “I/O Pair-connection Settings”, select **“PSUH”** from the **“Mode”** drop-down options.
5. Enter the **IP address for remote slave device (e.g., PETL-7060)** in the **“Remote IP”** field.
6. Enter the **TCP Port for remote slave device (e.g., PETL-7060)** in the **“Remote Port”** field.
7. Enter a **DI Count Value for ET-2260 #1 module** in the **“DI Count”** field (Local DI to Remote DO).

For example, enter **“2”** in the **“DI Count”** field. This means **DI x2 of the ET-2260 #1 module is mapped to DO x2 of the PETL-7060 module.**

8. Enter the **DO address for remote slave device (e.g., PETL-7060)** in the **“DO Addr”** field (Local DI to Remote DO).

For example, enter **“0”** in the **“DO Addr”** field. This means **DO addresses DO0 and DO1 of the PETL-7060 module are mapped to DI x2 of ET-2260 #1 module.**

9. Select **Modbus protocol (e.g., “TCP”)** from the **“TCP/UDP”** drop-down options.
10. Click the **“Submit”** button to complete the configuration.

I/O Pair-Connection Settings:

Figure 5-4.3

POLL Mode: (Remote DI -> Local DO)

PUSH Mode: (Local DI -> Remote DO)

Function in "BLUE" text available in "PUSH" Mode Only

| 1~5 | 6~10 | 11~12 |

#	Mode	Remote IP	Remote Port	Net ID	Scan Time	DI Count	DI Addr	DO Addr	TCP/UDP	Update
01	PUSH	10 0 8 55	502	1	1000 ms	2	0	0	TCP	Submit
02	Disable	0 0 0 0	502	1	1000 ms	0	0	0	TCP	Submit
03	Disable	0 0 0 0	502	1	1000 ms	0	0	0	TCP	Submit
04	Disable	0 0 0 0	502	1	1000 ms	0	0	0	TCP	Submit
05	Disable	0 0 0 0	502	1	1000 ms	0	0	0	TCP	Submit

Step 4: Configure the I/O Pair connection on the ET-2260 #2 module

1. In the eSearch Utility, select **ET-2260 #2 module** and then click the **“Web”** button to launch the browser program and connect to the web server.
2. Enter the password in the Login password field (**the default password is “Admin”**), and then click the **“Submit”** button to display the configuration page.
3. Click the **“Pair Connection”** tab to display the I/O Pair-connection Settings page.

Refer to [Figures 5-1.3 to 5-1.4](#) for illustrations of how to perform the above procedure.

4. In the “I/O Pair-connection Settings”, select **“PSUH”** from the **“Mode”** drop-down options.
5. Enter the **IP address for remote slave device (e.g., PETL-7060)** in the **“Remote IP”** field.
6. Enter the **TCP Port for remote slave device (e.g., PETL-7060)** in the **“Remote Port”** field.
7. Enter a **DI Count Value for ET-2260 #2 module** in the **“DI Count”** field (Local DI to Remote DO).

For example, enter **“2”** in the **“DI Count”** field. This means **DI x2 of the ET-2260 #2 module is mapped to DO x2 of the PETL-7060 module.**

8. Enter the **DO address for remote slave device (e.g., PETL-7060)** in the **“DO Addr”** field (Local DI to Remote DO).

For example, enter **“2”** in the **“DO Addr”** field. This means **DO addresses DO2 and DO3 of the PETL-7060 module are mapped to DI x2 of ET-2260 #2 module.**

9. Select **Modbus protocol (e.g., “TCP”)** from the **“TCP/UDP”** drop-down options.
10. Click the **“Submit”** button to complete the configuration.

I/O Pair-Connection Settings:

Figure 5-4.4

POLL Mode: (Remote DI -> Local DO)

PUSH Mode: (Local DI -> Remote DO)

Function in "BLUE" text available in "PUSH" Mode Only

| 1~5 | 6~10 | 11~12 |

#	Mode	Remote IP	Remote Port	Net ID	Scan Time	DI Count	DI Addr	DO Addr	TCP/UDP	Update
01	PUSH	10 0 8 55	502	1	1000 ms	2	0	2	TCP	Submit
02	Disable	0 0 0 0	502	1	1000 ms	0	0	0	TCP	Submit
03	Disable	0 0 0 0	502	1	1000 ms	0	0	0	TCP	Submit
04	Disable	0 0 0 0	502	1	1000 ms	0	0	0	TCP	Submit
05	Disable	0 0 0 0	502	1	1000 ms	0	0	0	TCP	Submit

6. Modbus Information

The ET-2200 series is a family of IP-based Modbus I/O devices that allow you to remotely control DI/DO terminals via an Ethernet connection and uses a master-slave communication technique in which only one device (the master) can initiate a transaction (called queries), while other devices (slaves) respond by either supplying the requested data to the master, or by taking the action requested in the query.

Most SCADA (Supervisory Control and Data Acquisition) and HMI software, such as Citect (Schneider Electric), ICONICS, iFIX, InduSoft, Intouch, Entivity Studio, Entivity Live, Entivity VLC, Trace Mode, Wizcon (EIUTIONS), and Wonderware, etc. can be used to easily integrate serial devices via the Modbus protocol.

Modbus/TCP master applications can also be developed using any programming language, such as VB, C# and so on.

ICP DAS provides the Modbus SDK that allows development of Modbus applications on a PC.

The relevant demo programs and SDK can be obtained from the following locations:

VB Demo: http://ftp.icpdas.com/pub/cd/6000cd/napdos/et7000_et7200/demo/pc_client/

.Net demo and SDK: <http://ftp.icpdas.com/pub/cd/8000cd/napdos/modbus/nmodbus/>

6.1 What is Modbus TCP/IP?

Modbus is a communication protocol that was developed by Modicon Inc. in 1979, and was originally designed for use with Modicon controllers. Detailed information regarding the Modbus protocol can be found at: <http://www.modbus.org>.

The different versions of the Modbus protocol used today include Modbus RTU, which is based on serial communication interfaces such as RS-485 and RS-232, Modbus ASCII and Modbus TCP, which uses the Modbus RTU protocol embedded into TCP packets.

Modbus TCP is an internet protocol. The protocol embeds a Modbus frame into a TCP frame so that a connection oriented approach is obtained, thereby making it more reliable. The master queries the slave and the slave responds with a reply. The protocol is open and, hence, highly scalable.

6.2 Modbus Message Structure

Modbus devices communicate using a master-slave (client-server) technique in which only one device (the master/client) can initiate transactions (called queries). The other devices (slaves/servers) respond by either supplying the requested data to the master, or by taking the action requested in the query.

A query from a master will consist of a slave address (or broadcast address), a function code defining the requested action, any required data, and an error checking field. A response from a slave consists of fields confirming the action taken, any data to be returned, and an error checking field.

➤ The Modbus/TCP Message Structure

Bytes 00 - 05	Bytes 06 - 11
6-byte header	RTU Data

➤ The Leading 6 bytes of a Modbus/TCP Protocol Query

Byte 00	Byte 01	Byte 02	Byte 03	Byte 04	Byte 05
Transaction Identifier		Protocol Identifier		Length Field (upper byte)	Length Field (lower byte)

- ✓ **Transaction identifier** = Assigned by the Modbus/TCP master (client)
- ✓ **Protocol identifier** = 0
- ✓ **Length field (upper byte)** = 0 (since all messages are smaller than 256)
- ✓ **Length field (lower byte)** = The number of following RTU data bytes

➤ RTU Data Structure

Byte 06	Byte 07	Bytes 08 - 09	Bytes 10 - 11
Net ID (Station Number)	Function Code	Data Field	
		Reference Number (Address Mapping)	Number of Points

- ✓ **Net ID** specifies the address of the receiver (Modbus/TCP slave).
- ✓ **Function Code** specifies the message type.
- ✓ **Data Field** is the data block.

Net ID (Station Number)

The first byte in the frame structure of a Modbus RTU query is the receiver's address. A valid address is in the range of 0 to 247. Address 0 is used for general broadcast, while addresses 1 to 247 are given to individual Modbus devices.

Function Code

The second byte in the frame structure of a Modbus RTU query is the function code, which describes what the slave device is required to do. Valid function codes are between 1 and 255. To answer the query, the slave device uses the same function code as contained in the request. The highest bit of the function code will only be set to '1' if an error occurs in the system. In this way, the master will know whether the message has been transmitted correctly or not.

Section	Code	Function	Reference (Address)
6.2.1	01 (0x01)	Read the Status of the Coils (Readback DOs)	0xxxx
6.2.2	02 (0x02)	Read the Status of the Input (Reads DIs)	1xxxx
6.2.3	03 (0x03)	Read the Holding Registers (Readback AOs)	4xxxx
6.2.4	04 (0x04)	Read the Input Registers (Reads AIs)	3xxxx
6.2.5	05 (0x05)	Force a Single Coil (Writes DO)	0xxxx
6.2.6	06 (0x06)	Preset a Single Register (Writes AO)	4xxxx
6.2.7	15 (0x0F)	Force Multiple Coils (Writes DOs)	0xxxx
6.2.8	16 (0x10)	Preset Multiple Registers (Writes AOs)	4xxxx

Data Field

Data is transmitted in 8-, 16- and 32-bit format. The data for 16-bit registers is transmitted in high-byte first format. For example: 0x0A0B ==> 0x0A, 0x0B. The data for 32-bit registers is transmitted as two 16-bit registers, and is low-word first. For example: 0x0A0B0C0D ==> 0x0C, 0x0D, 0x0A, 0x0B.

The data field of messages sent between a master and a slave contains additional information about the action to be taken by the master or any information requested by the slave. If the master does not require this information, the data field can be empty.

Reference (Address)	Description
0xxxx	<p><u>Read/Write Discrete Outputs or Coils.</u></p> <p>A 0x reference address is used to output device data to a digital output channel.</p>
1xxxx	<p><u>Read Discrete Inputs.</u></p> <p>The ON/OFF status of a 1x reference address is controlled by the corresponding digital input channel.</p>
3xxxx	<p><u>Read Input Registers.</u></p> <p>A 3x reference register contains a 16-bit number received from an external source, e.g. an analog signal.</p>
4xxxx	<p><u>Read/Write Output or Holding Registers.</u></p> <p>A 4x register is used to store 16 bits of numerical data (binary or decimal), or to send the data from the CPU to an output channel.</p>

 *For more details regarding Address Mapping (Reference Number), refer to [Section 6.3 “Modbus Register Table”](#).*

6.2.1 01(0x01) Read the Status of the Coils (Readback DOs)

This function code is used to read either the current status of the coils or the current digital output readback value from the ET-2200 series module.

[Request]

Byte	Description	Size	Value
00	Net ID (Station Number)	1 Byte	1 to 247
01	Function Code	1 Byte	0x01
02-03	Starting DO Address	2 Bytes	Refer to the Modbus Address Table (Section 6.3 “Modbus Register Table”) for the ET-2200 series module. Byte 02 = high byte Byte 03 = low byte
04-05	Number of Points (Channels)	2 Bytes	Byte 04 = high byte Byte 05 = low byte

[Response]

Byte	Description	Size	Value
00	Net ID (Station Number)	1 Byte	1 to 247
01	Function Code	1 Byte	0x01
02	Byte Count	1 Byte	Byte Count of the Response ($n = (\text{Points}+7)/8$)
03	Data	n Bytes	n= 1; Byte 03 = data bit 7 to 0 n= 2; Byte 04 = data bit 15 to 8 n= m; Byte m+2 = data bit (8m-1) to 8(m-1)

[Error Response]

Byte	Description	Size	Value
00	Net ID (Station Number)	1 Byte	1 to 247
01	Function Code	1 Byte	0x81
02	Exception Code	1 Byte	Refer to the Modbus Standard Specifications for more details

Example: Function 01 (0x01), Readback Dos

➤ Reads the Digital Output value

Command:	[Leading 6 bytes] <u>01 02 00 00 00 06</u>	[Request] <u>01 01 00 00 00 02</u>
Response:	[Leading 6 bytes] <u>01 02 00 00 00 04</u>	[Response] <u>01 01 01 03</u>

➤ A description of the command and response is as follows:

Command:	[Leading 6 bytes]	
	Bytes 00-03	01 02 00 00 (Message Number)
	Bytes 04-05	00 06 (Number of bytes remaining in this frame)
	[Request]	
	Byte 00	01 (Net ID)
	Byte 01	01 (Function Code)
	Byte 02-03	00 00 (Starting DO Address)
	Byte 04-05	00 02 (Number of Points)

Response:	[Leading 6 bytes]	
	Bytes 00-03	01 02 00 00 (Message Number)
	Bytes 04-05	00 04 (Number of bytes remaining in this frame)
	[Response]	
	Byte 00	01 (Net ID)
	Byte 01	01 (Function Code)
	Byte 02	01 (Byte Count of the Response)
	Byte 03	03 (Value for DO0 to DO1)

6.2.2 02(0x02) Read the Status of the Input (Read DIs)

This function code is used to read the current digital input value from the ET-2200 series module.

[Request]

Byte	Description	Size	Value
00	Net ID (Station Number)	1 Byte	1 to 247
01	Function Code	1 Byte	0x02
02-03	Starting DI Address	2 Bytes	Refer to the Modbus Address Table (Section 6.3 “Modbus Register Table”) for the ET-2200 series module. Byte 02 = high byte Byte 03 = low byte
04-05	Number of Points (Channels)	2 Bytes	Byte 04 = high byte Byte 05 = low byte

[Response]

Byte	Description	Size	Value
00	Net ID (Station Number)	1 Byte	1 to 247
01	Function Code	1 Byte	0x02
02	Byte Count	1 Byte	Byte Count of Response ($n = (\text{Points} + 7) / 8$)
03	Data	n Bytes	n= 1; Byte 03 = data bit 7 to 0 n= 2; Byte 04 = data bit 15 to 8 n= m; Byte m+2 = data bit (8m-1) to 8(m-1)

[Error Response]

Byte	Description	Size	Value
00	Net ID (Station Number)	1 Byte	1 to 247
01	Function Code	1 Byte	0x82
02	Exception Code	1 Byte	Refer to the Modbus Standard Specifications for more details

Example: Function 02 (0x02), Read DIs

➤ Reads the Digital Input value

Command:	[Leading 6 bytes] <u>01 02 00 00 00 06</u>	[Request] <u>01 02 00 00 00 02</u>
Response:	[Leading 6 bytes] <u>01 02 00 00 00 04</u>	[Response] <u>01 02 01 03</u>

➤ A description of the command and response is as follows:

Command:	[Leading 6 bytes]
Bytes 00-03	01 02 00 00 (Message Number)
Bytes 04-05	00 06 (Number of bytes remaining in this frame)
	[Request]
Byte 00	01 (Net ID)
Byte 01	02 (Function Code)
Byte 02-03	00 00 (Starting DI Address)
Byte 04-05	00 02 (Number of Points)

Response:	[Leading 6 bytes]
Bytes 00-03	01 02 00 00 (Message Number)
Bytes 04-05	00 04 (Number of bytes remaining in this frame)
	[Response]
Byte 00	01 (Net ID)
Byte 01	02 (Function Code)
Byte 02	01 (Byte Count of the Response)
Byte 03	03 (Value for DI0 to DI1)

6.2.3 03(0x03) Read the Holding Registers (Readback AOs)

This function code is used to readback either the current values in the holding registers or the analog output value from the ET-2200 series module. These registers are also used to store the preset values for the digital counter, the host watchdog timer, the module name and the TCP timeout, etc.

[Request]

Byte	Description	Size	Value
00	Net ID (Station Number)	1 Byte	1 to 247
01	Function Code	1 Byte	0x03
02-03	Starting AO Address	2 Bytes	Refer to the Modbus Address Table (Section 6.3 “Modbus Register Table”) for the ET-2200 series module. Byte 02 = high byte Byte 03 = low byte
04-05	Number of 16-bit Registers (Channels)	2 Bytes	Word Count Byte 04 = high byte Byte 05 = low byte

[Response]

Byte	Description	Size	Value
00	Net ID (Station Number)	1 Byte	1 to 247
01	Function Code	1 Byte	0x03
02	Byte Count	1 Byte	Byte Count of the Response (n=Points x 2 Bytes)
03~	Register Values	n Bytes	Register Values n= 2; Byte 03 = high byte Byte 04 = low byte n= m; Byte 03 = high byte Byte 04 = low byte Byte m+1 = high byte Byte m+2 = low byte

[Error Response]

Byte	Description	Size	Value
00	Net ID (Station Number)	1 Byte	1 to 247
01	Function Code	1 Byte	0x83
02	Exception Code	1 Byte	Refer to the Modbus Standard Specifications for more details

Example: Function 03 (0x03), Read AOs

- Reads the name of the module for the ET-2260

	[Leading 6 bytes]	[Request]
Command:	<u>01 02 00 00 00 06</u>	<u>01 03 01 03 00 01</u>
	[Leading 6 bytes]	[Response]
Response:	<u>01 02 00 00 00 07</u>	<u>01 03 02 22 60</u>

- A description of the command and response is as follows:

Command:	[Leading 6 bytes]	
	Bytes 00-03	01 02 00 00 (Message Number)
	Bytes 04-05	00 06 (Number of bytes remaining in this frame)
	[Request]	
	Byte 00	01 (Net ID)
	Byte 01	03 (Function Code)
	Byte 02-03	01 03 (Starting AO Address)
	Byte 04-05	00 01 (Number of Points)

Response:	[Leading 6 bytes]	
	Bytes 00-03	01 02 00 00 (Message Number)
	Bytes 04-05	00 07 (Number of bytes remaining in this frame)
	[Response]	
	Byte 00	01 (Net ID)
	Byte 01	03 (Function Code)
	Byte 02	02 (Byte Count of the Response)
	Byte 03-04	22 60 (Module Name)

6.2.4 04(0x04) Read the Input Registers (Read AIs)

This function code is used to read either the input registers or the current analog input value from the ET-2200 series module. These registers are also used to store the current value for the digital counter, the number of DI channels and the number of DO channels, etc.

[Request]

Byte	Description	Size	Value
00	Net ID (Station Number)	1 Byte	1 to 247
01	Function Code	1 Byte	0x04
02-03	Starting AI Address	2 Bytes	Refer to the Modbus Address Table (Section 6.3 “Modbus Register Table”) for the ET-2200 series module. Byte 02 = high byte Byte 03 = low byte
04-05	Number of 16-bit Registers (Channels)	2 Bytes	Word Count Byte 04 = high byte Byte 05 = low byte

[Response]

Byte	Description	Size	Value
00	Net ID (Station Number)	1 Byte	1 to 247
01	Function Code	1 Byte	0x04
02	Byte Count	1 Byte	Byte Count of the Response (n=Points x 2 Bytes)
03~	Register Values	n Bytes	Register Values n= 2; Byte 03 = high byte Byte 04 = low byte n= m; Byte 03 = high byte Byte 04 = low byte Byte m+1 = high byte Byte m+2 = low byte

[Error Response]

Byte	Description	Size	Value
00	Net ID (Station Number)	1 Byte	1 to 247
01	Function Code	1 Byte	0x84
02	Exception Code	1 Byte	Refer to the Modbus Standard Specifications for more details.

Example: Function 04 (0x04), Read AIs

- Reads the number of the DI channels on the ET-2260

Command:	[Leading 6 bytes] <u>01 02 00 00 00 06</u>	[Request] <u>01 04 00 64 00 01</u>
Response:	[Leading 6 bytes] <u>01 02 00 00 00 05</u>	[Response] <u>01 04 02 00 02</u>

- A description of the command and response is as follows:

Command:	[Leading 6 bytes]
Bytes 00-03	01 02 00 00 (Message Number)
Bytes 04-05	00 06 (Number of bytes remaining in this frame)
	[Request]
Byte 00	01 (Net ID)
Byte 01	04 (Function Code)
Byte 02-03	00 64 (Starting AI Address)
Byte 04-05	00 01 (Number of 16-bit Registers)

Response:	[Leading 6 bytes]
Bytes 00-03	01 02 00 00 (Message Number)
Bytes 04-05	00 05 (Number of bytes remaining in this frame)
	[Response]
Byte 00	01 (Net ID)
Byte 01	04 (Function Code)
Byte 02	02 (Byte Count of the Response)
Byte 03-04	00 02 (Number of DI channels on the ET-2260)

6.2.5 05(0x05) Force a Single Coil (Write DO)

This function code is used to set the status of a single coil or a single digital output value for the ET-2200 series module.

[Request]

Byte	Description	Size	Value
00	Net ID (Station Number)	1 Byte	1 to 247
01	Function Code	1 Byte	0x05
02-03	DO Address	2 Bytes	Refer to the Modbus Address Table (Section 6.3 “Modbus Register Table”) for the ET-2200 series module. Byte 02 = high byte Byte 03 = low byte
04-05	Output Value	2 Bytes	0xFF 00 sets the output to ON. 0x00 00 sets the output to OFF. All other values are invalid and will not affect the coil. Byte 04 = high byte Byte 05 = low byte

[Response]

Byte	Description	Size	Value
00	Net ID (Station Number)	1 Byte	1 to 247
01	Function Code	1 Byte	0x05
02-03	DO Address	2 Bytes	The value is the same as Bytes 02-03 of the Request
04-05	Output Value	2 Bytes	The value is the same as Bytes 04-05 of the Request

[Error Response]

Byte	Description	Size	Value
00	Net ID (Station Number)	1 Byte	1 to 247
01	Function Code	1 Byte	0x85
02	Exception Code	1 Byte	Refer to the Modbus Standard Specifications for more details.

Example: Function 05 (0x05), Write DO

➤ **Sets channel DO1 to ON**

Command:	[Leading 6 bytes] <u>01 02 00 00 00 06</u>	[Request] <u>01 05 00 01 FF 00</u>
Response:	[Leading 6 bytes] <u>01 02 00 00 00 06</u>	[Response] <u>01 05 00 01 FF 00</u>

➤ **A description of the command and response is as follows:**

Command:	[Leading 6 bytes]
	Bytes 00-03 01 02 00 00 (Message Number)
	Bytes 04-05 00 06 (Number of bytes remaining in this frame)
	[Request]
	Byte 00 01 (Net ID)
	Byte 01 05 (Function Code)
	Byte 02-03 00 01 (DO Address)
	Byte 04-05 FF 00 (Sets the output to ON)

Response:	[Leading 6 bytes]
	Bytes 00-03 01 02 00 00 (Message Number)
	Bytes 04-05 00 06 (Number of bytes remaining in this frame)
	[Response]
	Byte 00 01 (Net ID)
	Byte 01 05 (Function Code)
	Byte 02-03 00 01 (DO Address)
	Byte 04-05 FF 00 (Indicates that the DO has been set to ON)

6.2.6 06(0x06) Preset a Single Register (Write A0)

This function code is used to set a specific holding register to store the configuration values for the ET-2200 series module.

[Request]

Byte	Description	Size	Value
00	Net ID (Station Number)	1 Byte	1 to 247
01	Function Code	1 Byte	0x06
02-03	AO Address	2 Bytes	Refer to the Modbus Address Table (Section 6.3 “Modbus Register Table”) for the ET-2200 series module. Byte 02 = high byte Byte 03 = low byte
04-05	Register Value	2 Bytes	Register Value Byte 04 = high byte Byte 05 = low byte

[Response]

Byte	Description	Size	Value
00	Net ID (Station Number)	1 Byte	1 to 247
01	Function Code	1 Byte	0x06
02-03	AO Address	2 Bytes	The value is the same as Bytes 02-03 of the Request
04-05	Register Value	2 Bytes	The value is the same as Bytes 04-05 of the Request

[Error Response]

Byte	Description	Size	Value
00	Net ID (Station Number)	1 Byte	1 to 247
01	Function Code	1 Byte	0x86
02	Exception Code	1 Byte	Refer to the Modbus Standard Specifications for more details.

Example: Function 06 (0x06), Write AO

- Sets the system timeout to 60 seconds

Command:	[Leading 6 bytes] <u>01 02 00 00 00 06</u>	[Request] <u>01 06 01 08 00 3C</u>
Response:	[Leading 6 bytes] <u>01 02 00 00 00 06</u>	[Response] <u>01 06 01 08 00 3C</u>

- A description of the command and response is as follows:

Command:	[Leading 6 bytes]
Bytes 00-03	01 02 00 00 (Message Number)
Bytes 04-05	00 06 (Number of bytes remaining in this frame)
	[Request]
Byte 00	01 (Net ID)
Byte 01	06 (Function Code)
Byte 02-03	01 08 (AO Address)
Byte 04-05	00 3C (Sets the system timeout to 60 seconds)

Response:	[Leading 6 bytes]
Bytes 00-03	01 02 00 00 (Message Number)
Bytes 04-05	00 06 (Number of bytes remaining in this frame)
	[Response]
Byte 00	01 (Net ID)
Byte 01	06 (Function Code)
Byte 02-03	01 08 (AO Address)
Byte 04-05	00 3C (Indicates that the system timeout has been set to 60 seconds)

6.2.7 15(0x0F) Force Multiple Coils (Write DOs)

This function code is used to set multiple coils status or write multiple digital output values for the ET-2200 series module.

[Request]

Byte	Description	Size	Value
00	Net ID (Station Number)	1 Byte	1 to 247
01	Function Code	1 Byte	0x0F
02-03	Starting DO Address	2 Bytes	Refer to the Modbus Address Table (Section 6.3 “Modbus Register Table”) for ET-2200 series module. Byte 02 = high byte Byte 03 = low byte
04-05	Number of Output Channels (Points)	2 Bytes	Byte 04 = high byte Byte 05 = low byte
06	Byte count	1 Byte	$n = (\text{Points} + 7) / 8$
07	Output value	n Bytes	A bit corresponds to a channel. A value of 1 for a bit denotes that the channel is ON, while a value of denotes that the channel is OFF. n= 1; Byte 07 = data bit 7 to 0 n= 2; Byte 08 = data bit 15 to 8 n= m; Byte m+6 = data bit (8m-1)to 8 (m-1)

[Response]

Byte	Description	Size	Value
00	Net ID (Station Number)	1 Byte	1 to 247
01	Function Code	1 Byte	0x0F
02-03	Starting DO Address	2 Bytes	The value is the same as Bytes 02-03 of the Request
04-05	Number of Output Channels (Points)	2 Bytes	The value is the same as Bytes 04-05 of the Request

[Error Response]

Byte	Description	Size	Value
00	Net ID (Station Number)	1 Byte	1to 247
01	Function Code	1 Byte	0x8F
02	Exception Code	1 Byte	Refer to the Modbus Standard Specifications for more details.

Example: Function 15 (0x0F), Write DOs

➤ Sets the safe value (DO0 ~ DO1)

Command:	[Leading 6 bytes] <u>01 02 00 00 00 08</u>	[Request] <u>01 0F 01 0B 00 02 01 03</u>
Response:	[Leading 6 bytes] <u>01 02 00 00 00 06</u>	[Response] <u>01 0F 01 0B 00 02</u>

➤ A description of the command and response is as follows:

Command:	[Leading 6 bytes]	
	Bytes 00-03	01 02 00 00 (Message Number)
	Bytes 04-05	00 08 (Number of bytes remaining in this frame)
	[Request]	
	Byte 00	01 (Net ID)
	Byte 01	0F (Function Code)
	Byte 02-03	01 0B (Starting DO Address)
	Byte 04-05	00 02 (Number of Output Channels)
	Byte 06	01 (Byte Count)
	Byte 07	03 (Output Value)

Response:	[Leading 6 bytes]	
	Bytes 00-03	01 02 00 00 (Message Number)
	Bytes 04-05	00 06 (Number of bytes remaining in this frame)
	[Response]	
	Byte 00	01 (Net ID)
	Byte 01	0F (Function Code)
	Byte 02-03	01 0B (Starting DO Address)
	Byte 04-05	00 02 (Number of Input Channels)

6.2.8 16(0x10) Preset Multiple Registers (Write AOs)

This function code is used to set multiple holding registers that are used to store the configuration values for the ET-2200 series module.

[Request]

Byte	Description	Size	Value
00	Net ID (Station Number)	1 Byte	1 to 247
01	Function Code	1 Byte	0x10
02-03	Starting AO Address	2 Bytes	Refer to the Modbus Address Table (Section 6.3 “Modbus Register Table”) for the ET-2200 series module. Byte 02 = high byte Byte 03 = low byte
04-05	Number of 16-bit Registers (Channels)	2 Bytes	Word Count. Byte 04 = high byte Byte 05 = low byte
06	Byte Count	1 Byte	n = Points x 2 Bytes
07	Register Values	n Bytes	Register Values. n= 2; Byte 03 = high byte Byte 04 = low byte n= m; Byte 03 = high byte Byte 04 = low byte Byte m+1 = high byte Byte m+2 = low byte

[Response]

Byte	Description	Size	Value
00	Net ID (Station Number)	1 Byte	1 to 247
01	Function Code	1 Byte	0x10
02-03	Starting AO Address	2 Bytes	The value is the same as Bytes 02-03 of the Request
04-05	Number of 16-bit Registers (Channels)	2 Bytes	The value is the same as Bytes 04-05 of the Request

[Error Response]

Byte	Description	Size	Value
00	Net ID (Station Number)	1 Byte	1 to 247
01	Function Code	1 Byte	0x90
02	Exception Code	1 Byte	Refer to the Modbus Standard Specifications for more details.

Example: Function 16 (0x10), Write AOs

- Sets the preset value for the digital counter

Command:	[Leading 6 bytes] <u>01 02 00 00 00 0B</u>	[Request] <u>01 10 00 32 00 01 02 03 E8 00 00</u>
Response:	[Leading 6 bytes] <u>01 02 00 00 00 06</u>	[Response] <u>01 10 00 32 00 01</u>

- A description of the command and response is as follows:

Command:	[Leading 6 bytes]
Bytes 00-03	01 02 00 00 (Message Number)
Bytes 04-05	00 0B (Number of bytes remaining in this frame)
	[Request]
Byte 00	01 (Net ID)
Byte 01	10 (Function Code)
Byte 02-03	00 32 (Starting AO Address)
Byte 04-05	00 01 (Number of 16-bit Registers)
Byte 06	02 (Byte Count)
Byte 07-10	03 E8 00 00 (Preset value for the digital counter)

Response:	[Leading 6 bytes]
Bytes 00-03	01 02 00 00 (Message Number)
Bytes 04-05	00 06 (Number of bytes remaining in this frame)
	[Response]
Byte 00	01 (Net ID)
Byte 01	10 (Function Code)
Byte 02-03	00 32 (Starting AO Address)
Byte 04-05	00 01 (word count)

6.3 Modbus Register Table

Data from 16-bit registers is transmitted in high-byte first order. For example: 0x0A0B ==> 0x0A, 0x0B. Data from 32-bit registers is transmitted as two 16-bit registers, and is in low-word first order. For example: 0x0A0B0C0D ==> 0x0C, 0x0D, 0x0A, 0x0B.

6.3.1 Common Functions

➤ 0xxxx: DO Address (Base 0)

Starting Address	Points	Description	Bits per Point	Range	Access Type
127 (0x7F)	1	Restores all default web settings	1	1 = Restore	W (Pulse)
128 (0x80)	1	Default ID Settings	1	1 = Restore	W (Pulse)
133 (0x85)	1	Reboots the ET-2200 module	1	1 = Reboot	W (Pulse)
Notes	"W": Write				

➤ 3xxxx: AI Address (Base 0)

Starting Address	Points	Description	Bits per Point	Range	Access Type
151 (0x97)	1	Firmware Version	16	"123" denotes that the version is 1.2.3	R
158 (0x9E)	1	Modbus Communication Status	16	0 = No Error 1 = Timeout	R
160 (0xA0)	1	Pair-Connection Status	16	0 = Normal 1 = Timeout 2 = Disconnected	R
Notes	"R": Read				

➤ **4xxxx: AO Address (Base 0)**

Starting Address	Points	Description	Bits per Point	Range	Access Type
255 (0xFF)	1	CPU Reset Status	16	1 = Reset at Power-on 2 = Reset by the WDT 3 = Reset using the reset command	R/W
257 (0x101)	1	Sets the Host Watchdog Timer (WDT)	16	<5: Disabled 5 to 65535: Enabled (units: seconds) 0: Default If the ET-2200 series module loses communication with the host PC for more than the period defined in the WDT settings, the DO channels will revert to their safe values and the Host WDT Events Counter will be increased by one.	R/W/F
258 (0x102)	1	Host WDT Events	16	Denotes how many Host WDT Events have occurred since the last CPU reset	R/W
259 (0x103)	1	Module Name	16	Module Name	R
263 (0x107)	1	Sets the TCP Timeout Value	16	<5: Disabled 5 to 65535: Enabled (units: seconds) 0: Default	R/W/F
264 (0x108)	1	Sets the System Timeout Value	16	<30: Disabled 30~65535: Enabled (unit: second) 0: default	R/W/F
Notes	<p>“R”: Read; “W”: Write; “F”: Setting is recorded in flash as default. Warning: Frequent writing to the Flash can cause it to become corrupt.</p>				

6.3.2 Specific Functions

The nDI and nDO parameters for each ET-2200 series module used in the following Modbus Address Tables are as follows:

Model Name	Universal DIO (UDIO)	Number of DO channels (nDO)	Number of DI channels (nDI)
ET-2242	-	16	-
ET-2251	-	-	16
ET-2254 ET-2254P	16	Depend on your configuration	Depend on your configuration
ET-2255	-	8	8
ET-2260	-	6	6
ET-2261	-	10	-
ET-2268	-	8	-

➤ 0xxxx: DO Address (Base 0)

Starting Address	Points	Description	Bits per Point	Range	Access Type
0 (0x00)	1 to nDO	Digital Output Channels	1	0 = Off 1 = On	R/W
32 (0x20)	1	Clears the status of all high latched DI Channels	1	1 = Clear	W
33 (0x21)	1	Clears the status of all low latched DI Channels	1	1 = Clear	W
34 (0x22)	1 to nDI	Clears the high speed digital counter for all DI Channels	1	1 = Clear	W
60 (0x3C)	1	Saves specific data to Flash (The access type for some registers is labeled with an "E")	1	1 = Clear	W
100 (0x64)	1 to nDO	Enables the PWM for all DO Channels	1	0 = Off 1 = On (Default= 0)	R/W
150 (0x96)	1	Enables the high and low latches for all DI Channels	1	0 = Disable 1 = Enable (Default= 0)	R/W/F
151 (0x97)	1 to nDI	Enables the high speed digital counter for all DI Channels	1	0 = Disable 1 = Enable (Default= 0)	R/W/F

190 (0xBE)	1 to nDI	Enables frequency measurement for all DI Channels	1	0 = Disable 1 = Enable (Default= 0)	R/W/F
235 (0xEB)	1 to nDO	Sets the Power-on value for all DO Channels	1	0 = Off 1 = On (Default= 0)	R/W/F
267 (0x10B)	1 to nDO	Sets the Safe value for all DO Channels	1	0 = Off 1 = On (Default= 0)	R/W/F
299 (0x12B)	1	Force the DI/DO Mode. (for the ET-2254 only) 0 = Dynamic I/O type based on DO requests. 1 = Static I/O type by configuration (web or Modbus).	1	0 = Dynamic 1= Static	R/W
300 ~ 315 (0x12C ~ 0x13B)	1 to UDIO	Sets the Universal DIO channels to DI or DO Port. (for the ET-2254 only) 300 is the CH0 address, 301 is the CH1 address, and so on.	1	0 = DO type 1= DI type	R/W
Notes	<p>“R”: Read “W”: Write “F”: Settings are recorded in flash by default “E”: After writing DO[60] register, the data will be stored in flash. Warning: Frequency writing to the Flash can cause it to become corrupt.</p>				

 *Because of the characteristics of the relay functions, it is recommended that the PWM on ET-2260/2261/2268 series (i.e., modules with relay functions) is not used for extended periods of time.*

➤ **1xxxx: DI Address (Base 0)**

Starting Address	Points	Description	Bits per Point	Range	Access Type
0 (0x00)	1 to nDI	The status of all Digital Input Channels	1	0 = Off 1 = On	R
32 (0x20)	1 to nDI	The status of all high latched DI Channels	1	0 = None 1 = Latched	R
64 (0x40)	1 to nDI	The status of all low latched DI Channels	1	0 = None 1 = Latched	R
Notes	"R": Read				

➤ **3xxxx: AI Address (Base 0)**

Starting Address	Points	Description	Bits per Point	Value	Access Type
16 (0x10)	1 to nDI	The Digital Counter Value	32	0 to 4294967296	R
64 (0x40)	1 to nDI	The frequency Value * 1,000. (Note: The Client must first divide the value by 1,000.)	32	0 to 4294967296	R
<p>⚠ Note: The “DI Counter (0x10)” and “DI Frequency (0x40)” that the records data as 32-bit value and is transmitted as two 16-bit registers. Consequently, the register address has an offset of 2, i.e., the address of the second channel will be at starting-address +2, and so on. You can refer to “FAQ003 How do I read DI Counter for the PETL/tET/tPET Series Modules correctly” for more detailed information.</p> <p>Example: Reads the 6 DI Counter on the ET-2260.</p> <div style="display: flex; justify-content: space-around; align-items: center;"> <div style="text-align: center;"> <p>[Leading 6 bytes]</p> <p>Command: 01 02 00 00 00 06</p> </div> <div style="text-align: center;"> <p>[Request]</p> <p>01 04 00 <u>10</u> 00 <u>0C</u></p> <div style="display: flex; justify-content: center; gap: 20px;"> <div style="text-align: center;"> <p>↓</p> <div style="border: 1px solid black; padding: 5px;">Starting Address</div> </div> <div style="text-align: center;"> <p>↓</p> <div style="border: 2px solid black; padding: 5px;">6 channels * 2 registers = 12 registers</div> </div> </div> </div> </div>					
100 (0x64)	1	Number of DI Channels	16	nDI	R
110 (0x6E)	1	Number of DO Channels	16	nDO	R
121 (0x79)	1	Number of high-speed counters	16	nDI	R
Notes	“R”: Read				

➤ 4xxxx: AO Address (Base 0)

Starting Address	Points	Description	Bits per Point	Range	Access Type
50 (0x32)	1 to nDI	The preset value for the high speed digital counter	32	0 to 4294967296	R/W/E

! *Note: “Preset DI Counter Value (0x32)” that the records data as 32-bit value and is transmitted as two 16-bit registers. Consequently, the register address has an offset of 2, i.e., the address of the second channel will be at starting-address +2, and so on. You can refer to [“FAQ003 How do I read DI Counter for the PETL/tET/tPET Series Modules correctly”](#) for more detailed information.*

Example: Reads the preset value of 6 DI Counter on the ET-2260.

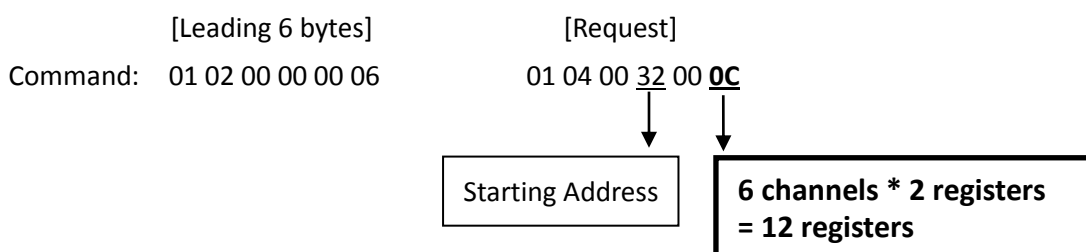

100 (0x64)	1 to nDO	The duty cycle for the DO PWM The first word (16-bit register) is the high pulse width, while the second word is the low pulse width. The units are in ms, and the resolution is about 10 ms.	32	0 to 65535; 0 to 65535;	R/W/E
150 (0x64)	1 to nDO	The Scan mode for the DI frequency measurement. Refer to Section 4.4.2 “DI/DO Configuration” for more details.	16	1000= 1000 ms 100= 100 ms 2000=Single pulse	R/W/F
200 (0x64)	1 to nDI	The moving average of the DI frequency measurement.	16	1=No average 2= Average 2 values 4= Average 4 values 8=Average 8 values	R/W/F

268 (0x10C)	1 to nDO	The Min-Switching Time for all DO Channels	16	1 to 65535 second	R/W/F
284 (0x11C)	1 to nDO	The Auto-off Time for all DO Channels	16	1 to 65535 second	R/W/F
Notes	<p>“R”: Read “W”: Write “F”: Settings are recorded in flash by default “E”: After writing the DO[60] register, the data will be stored in flash. Warning: Frequent writing to the Flash can cause it to become corrupt.</p>				