

LN-D70

Nano-ITX Motherboard

User's Manual

Edition 1.12

2014/11/27



Copyright

Copyright 2014, all rights reserved. This document is copyrighted and all rights are reserved. The information in this document is subject to change without prior notice to make improvements to the products.

This document contains proprietary information and protected by copyright. No part of this document may be reproduced, copied, or translated in any form or any means without prior written permission of the manufacturer.

All trademarks and/or registered trademarks contains in this document are property of their respective owners.

Disclaimer

The company shall not be liable for any incidental or consequential damages resulting from the performance or use of this product.

The company does not issue a warranty of any kind, express or implied, including without limitation implied warranties of merchantability or fitness for a particular purpose.

The company has the right to revise the manual or include changes in the specifications of the product described within it at any time without notice and without obligation to notify any person of such revision or changes.

Trademark

All trademarks are the property of their respective holders.

Any questions please visit our website at <http://www.commell.com.tw>

Packing List:

Please check the package content before you starting using the board.

Hardware:

LN-D70 Mini-ITX Motherboard x 1

Cable Kit:



SATA Cable x 2
OALSATA3-L / (1040529)



USB2.0 Cable x 1
OALUSBA-3/ (1040173) (Option)



Dual COM PORT Cable x 1
OALES-BKU2NB / (1040090)



CRT cable without bracket x 1
(OALVGA-SNB-7/ (1040557)



1 to 3 power output cable x 1
(OAL4P-2)/ (1040051)



DC Power Cable x 1
(OALDC-A)/ (1040433)



SATA Power Cable x 1
(OAL4P-S2)/ (1040054)



Audio Cable x 1
(OALPJ-HDUNB)/ (1040123)

Printed Matters:

Driver CD (Including User's Manual) x 1

Cooler:



(OHSF-6) / (2181010018)
LN-D70JIP, LV-D70JX2
LN-D70EIP, LV-D70EX2

Heat Sink:



(OHS-8) / (2181110010)
LN-D70NIP, LN-D70NX2

Index

Chapter 1 <Introduction>	5
1.1 <Product Overview>	5
1.2 <Product Specification>.....	6
1.3 <Mechanical Drawing>.....	8
1.4 <Block Diagram>.....	9
Chapter 2 <Hardware Setup>	9
2.1 <Connector Location>	9
2.2 <Jumper Location & Reference>.....	10
2.3 <Connector Reference>	11
2.3.1 <Internal Connectors>	11
2.4 < Memory Setup >.....	12
2.5 <CMOS & ATX Setup>	13
2.6 <Ethernet Interface>.....	14
2.7 <Onboard Display Interface>	14
2.7.1 <Display>.....	14
2.7.2 <LVDS>	15
2.7.3 <VGA Interface>	18
2.8 <Integrated Audio Interface>	19
2.9 <USB Interface>.....	21
2.9.1 < USB 3.0 eXtensible Host Controller Driver install >	21
2.10 <Serial Port>	25
2.11 <PCIe Mini Card and SIM Interface>	27
2.12 <GPIO and SMBUS Interface>.....	30
2.13 <Power Supply and Fan Interface >	31
2.13.1 <Power Input>	31
2.13.2 < Power Output >.....	32
2.13.3 <Fan connector>.....	32
2.14 <Switch and Indicator>.....	33
Chapter 3 <System Setup>	35

3.1 <Audio Configuration>.....	35
3.2 <Display Properties Setting>	35
3.3 <SATA configuration>	37
Chapter 4 <BIOS Setup>	38
Appendix A <I/O Port Pin Assignment>.....	39
A.1 <Serial ATA Port>	39
A.2 <LAN Port>	39
A.3 <LPC Port>	39
Appendix B <Flash BIOS>	40
B.1 <Flash Tool>	40
B.2 <Flash BIOS Procedure>.....	40
Appendix C <Programming GPIO's>	41
Appendix D <Programming Watchdog Timer >	42
Contact Information.....	43

Chapter 1 <Introduction>

1.1 <Product Overview>

LN-D70 is the system-on-chip (SoC) designed for intelligent systems, delivering outstanding compute, graphical, and media performance while operating in an extended range of thermal conditions. These SoCs are based on the Silvermont microarchitecture, utilizing Intel's industry-leading 22nm process technology with 3-D Tri-Gate transistors, which deliver significant improvements in computational performance and energy efficiency.

New features for Intel® Celeron® and Atom Processor

The Intel® Celeron® Processor J1900 / N2930 and Intel® Atom E3845 Processor supports, graphics, media performance, flexibility and more enhanced security that is suitable for a variety of intelligent systems the ideal choice.

Outstanding integration of I/O interfaces

Supports display interfaces with graphics processing, camera interfaces with image

processing, audio with digital signal processing, multiple storage types, and legacy embedded I/O. Provides interface expansion capabilities through industry-standard high-bandwidth interfaces such as PCI Express* Gen 2.0, Hi-speed USB 2.0, and USB 3.0 connectivity.

All in One multimedia solution

Based on Intel® J1900 / N2920 / E3845 SoC, the board provides high performance onboard graphics, CRT, 24-bit dual channel LVDS interface, Display Port, DVI and two channels High Definition Audio, to meet the very requirement of the multimedia application.

Flexible Extension Interface

The board provides one PCIe mini slot and one SIM slot.

1.2 <Product Specification>

General Specification

Form Factor	Nano-ITX motherboard.
CPU	Bay Trail Intel® Celeron™ J1900 / N2930 and Atom™ E3845 Mobile Processor. Package Type: FCBGA1170.
Memory	1 x DDR3L (support 1.35V) 1066/1333 SO-DIMM up to 8GB.
Real Time Clock	Chipset integrated RTC with onboard lithium battery.
Watchdog Timer	Generates a system reset with internal timer for 1min/s ~ 255min/s.
Power Management	Supports ACPI 5.0 compliant.
Serial ATA Interface	2 x SATAII(3Gb/s), 2 x SATAIII(6Gb/s).
VGA Interface	Intel® Clear Video integrated HD Graphics Technology.
DVI Interface	Onboard DVI connector. (DVI and LVDS1 can't be enabled simultaneously)
LVDS Interface	2 x Onboard 24-bit dual channel LVDS connector with +3.3V/+5V/+12V supply.
Display port Interface	Onboard Display port connector. (Display port and LVDS2 can't be enabled simultaneously)
Audio Interface	Realtek ALC262 High Definition Audio Codec.
LAN Interface	1 x Intel® I210 Gigabit LAN.
GPIO interface	Onboard programmable 8-bit Digital I/O interface.
Extended Interface	1 x PCIE Mini card or mSATA, 1 x SIM socket.

LN-D70 User's Manual

Internal I/O Port	4 x RS232, 1 x GPIO, 1 x Audio connector, 1 x SMBUS connector, 1 x CRT, 2 x LVDS, 1 x LPC, 2 x USB 2.0 and 2 x SATAII, 2 x SATAIII.
External I/O Port	1 x PS/2 Keyboard/Mouse Port, 1 x RS232, 1 x RS232/422/485, 1 x DVI port, 1 x Display port, 1 x RJ45 LAN ports, 1 x USB 3.0(XHCI) port, 1 x USB 2.0 port.
Power Requirement	6~27V full range DC Input.
Dimension	120mm x 120mm. (L x W)
Temperature	Operating within 0~60 °C .(for LN-D70J and LN-D70N serial) Operating within -40~75 °C .(for LN-D70E serial)

Ordering Code

LN-70DJIP	Intel Celeron Processor J1900 (2M Cache, 2.42GHz), DVI, Display Port, CRT, Gigabit LAN, USB3.0 & 2.0, Serial Port, SATAII, SATAIII, Audio, PCIE Mini card, , SMBUS, GPIO, SIM, LPC, mSATA.
LN-70DEIP	Intel Atom Processor E3845 (2M Cache, 1.91GHz), DVI, Display Port, CRT, Gigabit LAN, USB3.0 & 2.0, Serial Port, SATAII, SATAIII, Audio, PCIE Mini card, SMBUS, GPIO, SIM, LPC, mSATA.
LN-70DNIP	Intel Celeron Processor N2930 (2M Cache, 2.16GHz), DVI, Display Port, CRT, Gigabit LAN, USB3.0 & 2.0, Serial Port, SATAII, SATAIII, Audio, PCIE Mini card, SMBUS, GPIO, SIM, LPC, mSATA.
LN-70DJX2	Intel Celeron Processor J1900 (2M Cache, 2.42GHz), 2 x LVDS, CRT, Gigabit LAN, USB3.0 & 2.0, Serial Port, SATAII, SATAIII, Audio, PCIE Mini card, SMBUS, GPIO, SIM, LPC, mSATA.
LN-70DEX2	Intel Atom Processor E3845 (2M Cache, 1.91GHz), 2 x LVDS, CRT, Gigabit LAN, USB3.0 & 2.0, Serial Port, SATAII, SATAIII, Audio, PCIE Mini card, SMBUS, GPIO, SIM, LPC, mSATA.
LN-70DNX2	Intel Celeron Processor N2930 (2M Cache, 2.16GHz), 2 x LVDS, CRT, Gigabit LAN, USB3.0 & 2.0, Serial Port, SATAII, SATAIII, Audio, PCIE Mini card, SMBUS, GPIO, SIM, LPC, mSATA.

The specifications may be different as the actual production.

For further product information please visit the website at <http://www.comnell.com.tw>.

1.3 <Mechanical Drawing>

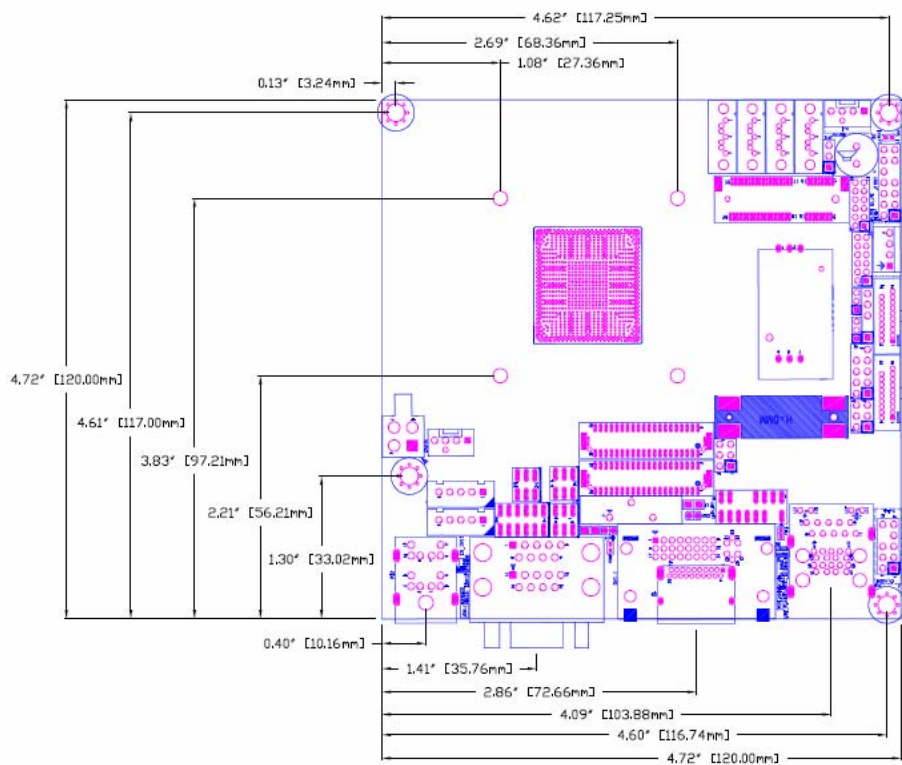

1.4 <Block Diagram>

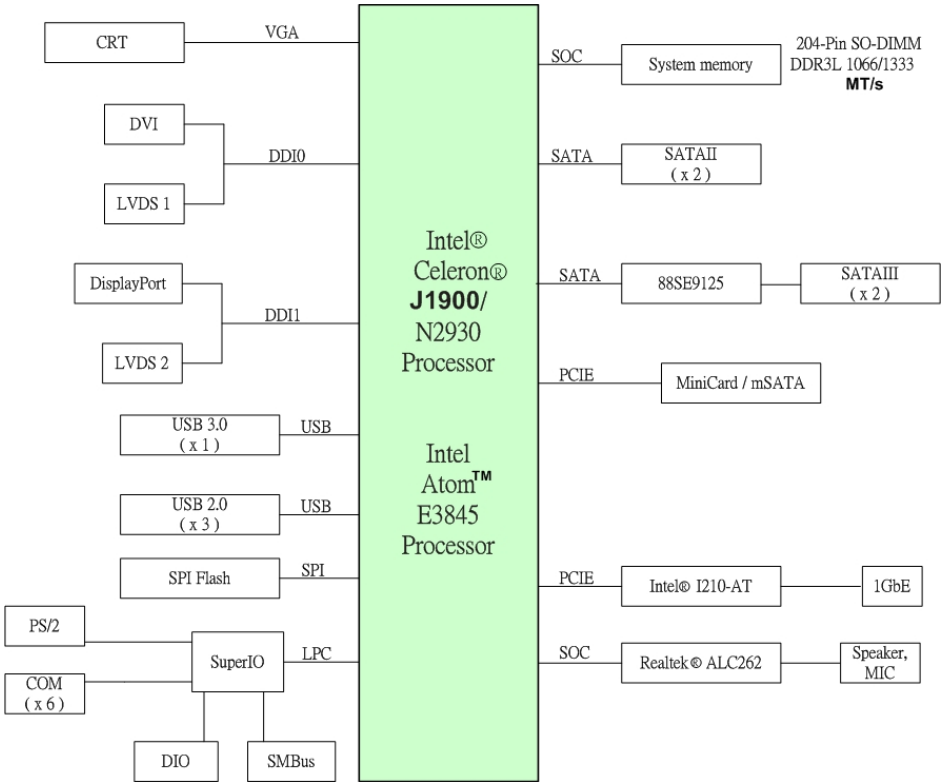

Chapter 2 <Hardware Setup>

2.1 <Connector Location>

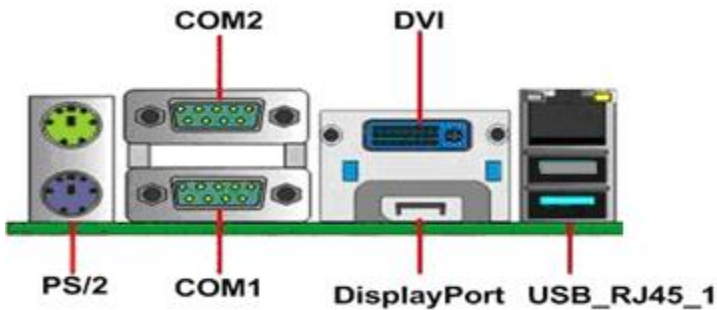

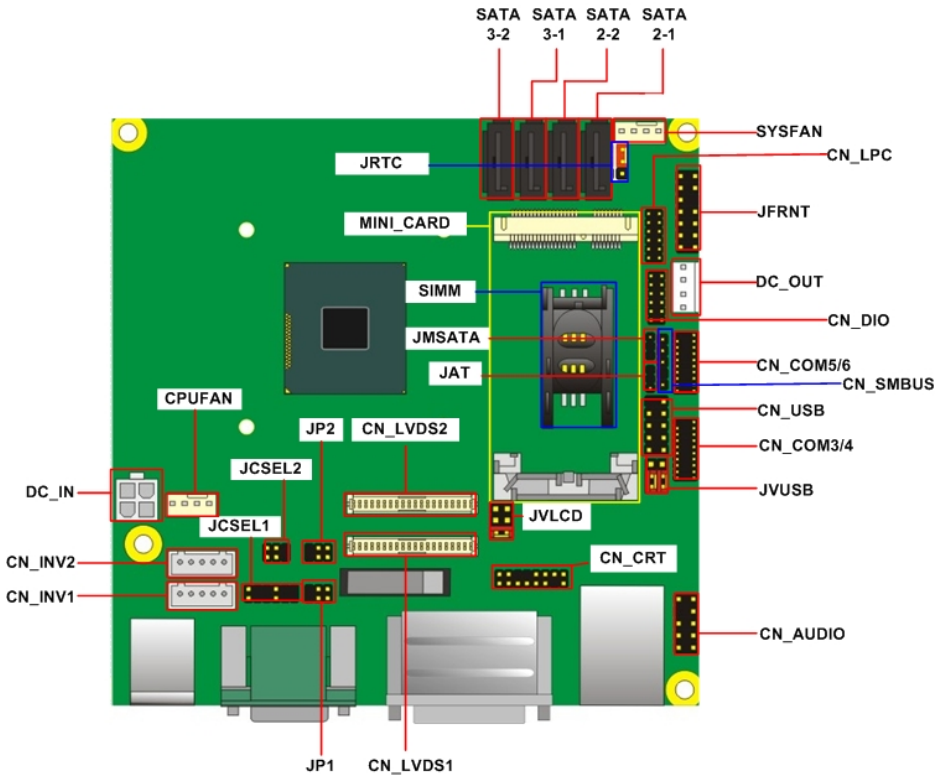

2.2 <Jumper Location & Reference>

Jumper	Function
JRTC	CMOS Operating/Clear Setting
JVLCD	Panel1、2 Voltage Setting
JAT	Power mode select
JP1	Com1 Voltage Setting (For Pin 9)
JP2	Com2 Voltage Setting (For Pin 9)
JCSEL1 JCSEL2	COM2 RS-232 RS422 RS485 Setting
JMSATA	Mini Card mSATA Setting
JVUSB	USB Voltage Setting

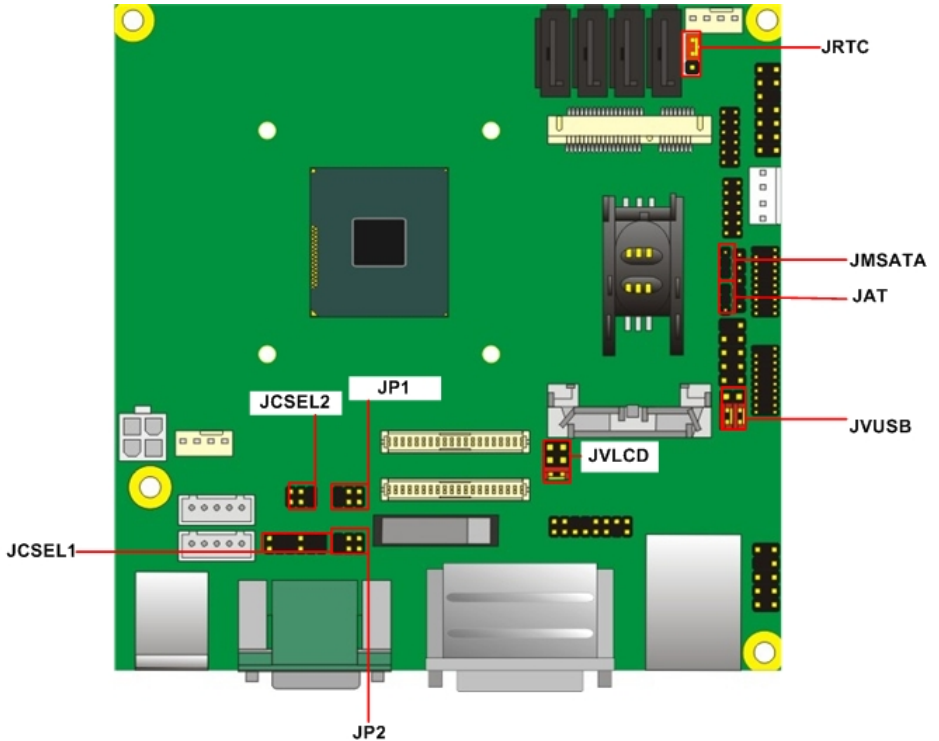

2.3 <Connector Reference>

2.3.1 <Internal Connectors>

Connector	Function	Remark
CPU	FCBGA1170 CPU	
SO-DIMM 1/2	204 -pin DDR3L SO-DIMM socket	
SATAII 1/2	7-pin Serial ATAII connector	
SATAIII 1/2	7-pin Serial ATAIII connector	
DC_IN	DC 6~27V input connector	
DC_OUT	4-pin DC output connector	
CN_AUDIO	5 x 2-pin audio connector	
CN_DIO	6 x 2-pin digital I/O connector	
CPUFAN	4-pin CPU cooler fan connector	
SYSFAN	4-pin system cooler fan connector	
CN_CRT	16-pin VGA connector	
CN_LVDS 1/2	20 x 2-pin LVDS connector	
CN_INV 1/2	5-pin LCD inverter connector	
CN_COM 3/4/5/6	9-pin RS232	

CN_LPC	5 x 2-pin LPC connector	
JFRNT	14-pin front panel switch/indicator connector	
Mini-PCIE	52-pin Mini-PCIE socket	
JAT	Power mode select	
SIMM	6-pin socket	
CN_SMBUS	5-pin SMBUS connector	
CN_USB	5 x 2-pin USB2.0 connector	

2.3.2 <External Connectors>

Connector	Function	Remark
USB_RJ45 1/2	1x USB3.0 / 2.0 , 1x USB2.0 , 1x RJ45 LAN connector	
DVI + Display port	DVI connect and Display port connector	
COM 1/2	Serial port connector	
PS/2	PS/2 keyboard and mouse connector	

2.4 < Memory Setup >

LN-D70 has two 204-pin DDR3L DIMM support up to 8GB of memory capacity and 1.35 Voltage. The memory frequency supports 1066/1333 MHz. Only Non-ECC memory is supported.

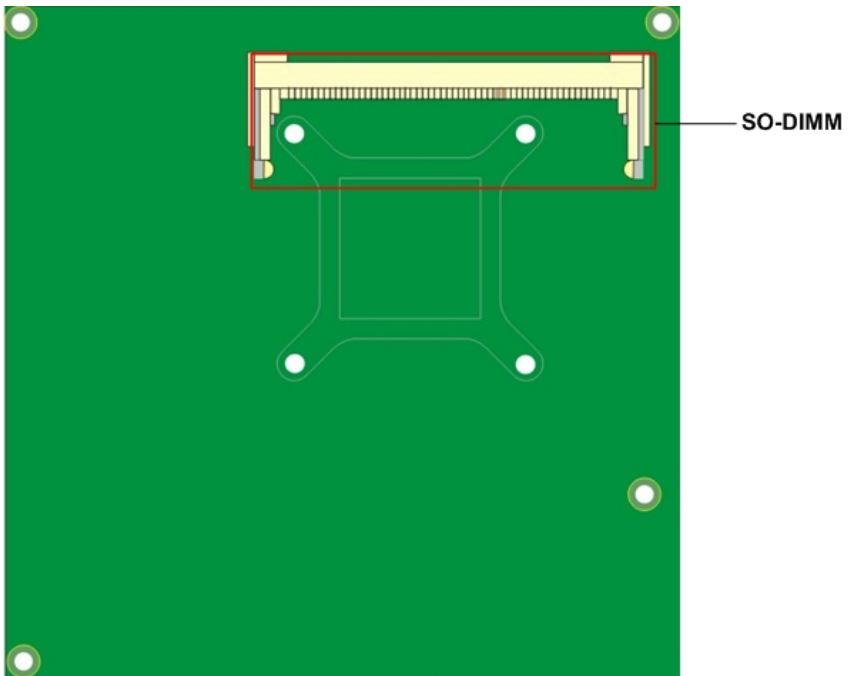

2.5 <CMOS & ATX Setup>

The board's data of CMOS can be setting in BIOS. If the board refuses to boot due to inappropriate CMOS settings, here is how to proceed to clear (reset) the CMOS to its default values.

Jumper: JRTC

Type: Onboard 3-pin jumper

JRTC	Mode
1-2	Clear CMOS
2-3	Normal Operation

Default setting: 2-3

Jumper: JAT

Type: onboard 3-pin jumper

JAT	Mode
1-2	AT Mode
2-3	ATX Mode

Default setting:2-3

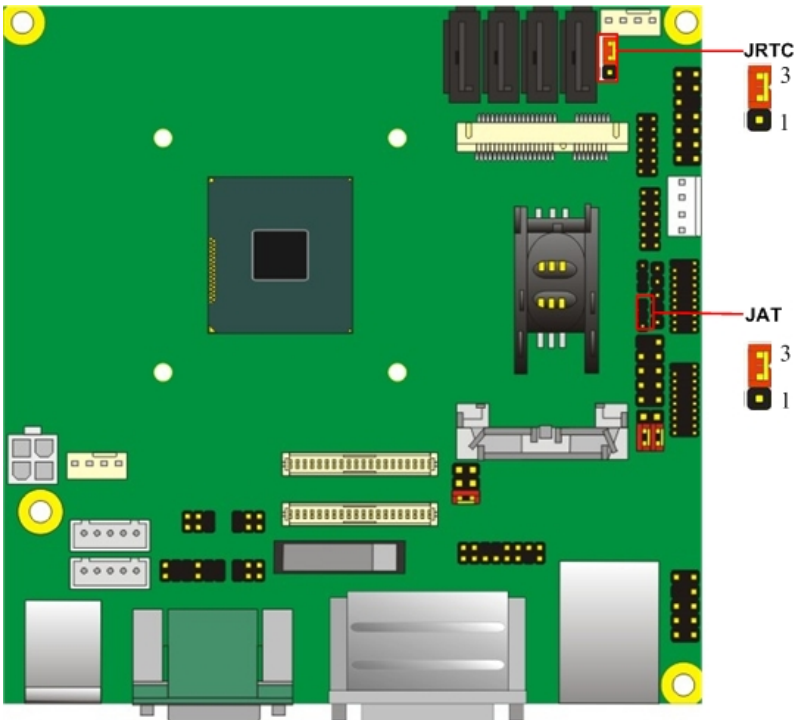

2.6 <Ethernet Interface>

The board integrates with Intel I210 Gigabit Ethernet, as the PCI Express bus. The Intel I210 supports triple speed of 10/100/1000Base-T, with IEEE802.3 compliance and Wake-On-LAN supported.

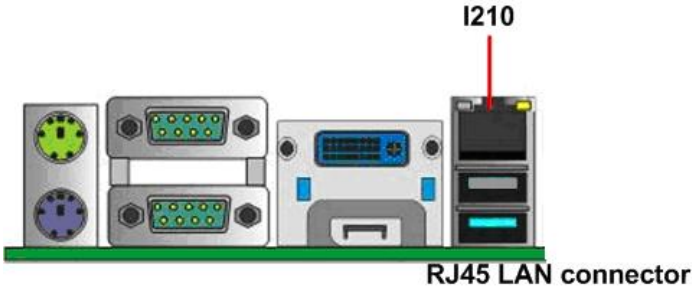

2.7 <Onboard Display Interface>

Based on Intel processor with built-in HD Graphic, the board provides one DVI connector & one Display port on real external I/O port, two 40-pin LVDS interface with 5-pin LCD backlight inverter connector and provides 16-pin VGA interface.

The board provides dual display function with clone mode and extended desktop mode for DVI, Display port, VGA and LVDS.

2.7.1 <Display>

Please connect your DVI & Display port or LCD monitor with male connector to the onboard female connector on rear I/O port .

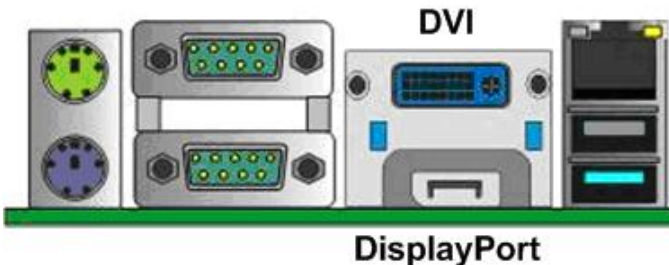

2.7.2 <LVDS>

The board provides two 40-pin LVDS connector for 18/24-bit single/dual channel panels, supports up to 1920 x 1080 resolution, with one LCD backlight inverter connector and two jumper for panel voltage setting. **Please install LVDS cable before boot up.**

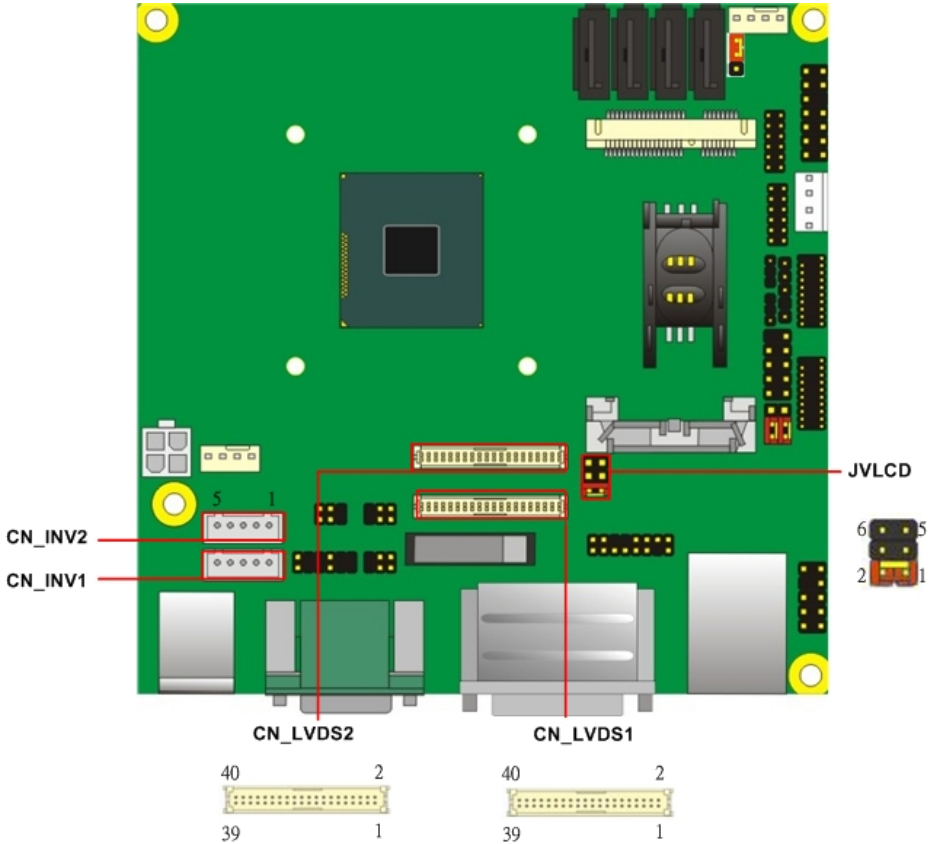

Effective patterns of connection: 1-2 / 3-4 / 5-6



Warning: others cause damage

Connector: **CN_INV1 and CN_INV2**

Type: 5-pin LVDS Power Header

Pin	Description
1	+12V
2	Reserved (Note)
3	GND
4	GND
5	ENABKL

Note1

1. LVDS1 (CN_INV1) and LVDS2 (CN_INV2) can be connected and enabled simultaneously but the PWM feature will not function if both LVDS1 and LVDS2 are enabled at the same time.
2. If you need PWM feature, an OEM model needs to be requested. But please be noted that PWM function does not support on both LVDS. Either LVDS1 or LVDS2 can have PWM feature supported. Please contact our Tech Support for detail information.

Connector: **JVLCD**

Type: 6-pin Power select Header

Pin	Description
1-2	LCDVCC (3.3V)
3-4	LCDVCC (5V)
5-6	LCDVCC (12V)

Default: 1-2Connector: **CN_LVDS1 and CN_LVDS2**

Type: onboard 40-pin connector for LVDS connector

Connector model: **HIROSE DF13-40DP-1.25V or compatible**

Pin	Signal	Pin	Signal
2	LCDVCC	1	LCDVCC
4	LVDSDET	3	GND
6	ATX0-	5	BTX0-
8	ATX0+	7	BTX0+
10	GND	9	GND
12	ATX1-	11	BTX1-
14	ATX1+	13	BTX1+
16	GND	15	GND
18	ATX2-	17	BTX2-
20	ATX2+	19	BTX2+
22	GND	21	GND
24	ACLK-	23	BTX3-
26	ACLK+	25	BTX3+
28	GND	27	GND
30	ATX3-	29	BCLK-
32	ATX3+	31	BCLK+

LN-D70 User's Manual

34	GND	33	GND
36	DDCPCLK	35	SMBCKL
38	DDCPDATA	37	SMBDATA
40	N/C	39	SPDIFO

To setup the LCD, you need the component below:

1. A panel with LVDS interfaces.
2. An inverter for panel's backlight power.
3. A LCD cable and an inverter cable.

For the cables, please follow the pin assignment of the connector to make a cable, because every panel has its own pin assignment, so we do not provide a standard cable; please find a local cable manufacture to make cables.

LCD Installation Guide:

1. Preparing the **LN-D70**, **LCD panel** and the **backlight inverter**.

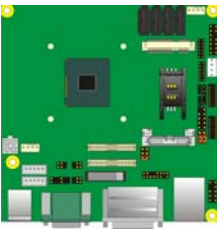

2. Please check the datasheet of the panel to see the voltage of the panel, and set the jumper **JVLCD** to +12V or +5V or +3.3V.
3. You would need a LVDS type cable.

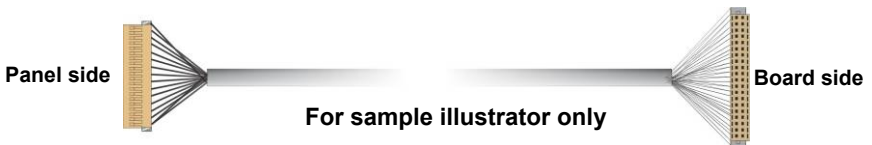

BIOS panel type selection form (BIOS Version:1.0)			
Single / Dual channel		Single / Dual channel	
NO.	Output format	NO.	Output format
1	640 x 480	9	1680 x 1050
2	800 x 600	10	1920 x 1200
3	1024 x 768	11	1440 x 900
4	1280 x 1024	12	1600 x 900
5	1400 x 1050	13	1024 x 768
6	1400 x 1050	14	1280 x 800
7	1600 x 1200	15	1920 x 1080
8	1366 x 768		

4. To connect all of the devices well.

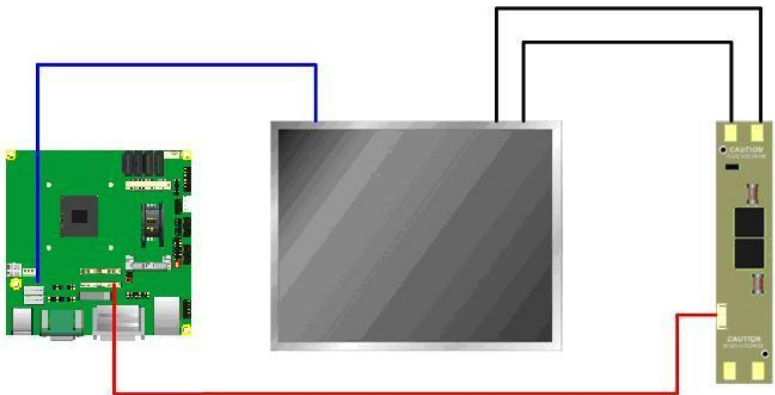

After setup the devices well, you need to select the LCD panel type in the BIOS.

The panel type mapping is list below:

2.7.3 <VGA Interface>

Connector: **CN_CRT**

Type: onboard 16-pin connector for CN_CRT connector pitch 2.00mm

Pin	Signal	Pin	Signal
1	BR	2	BG
3	BB	4	NC
5	-CRTATCH	6	IOGND1
7	IOGND1	8	IOGND1
9	NC	10	-CRTATCH
11	NC	12	5VCDA
13	5HSYNC	14	5VSYNC
15	5VCLK	16	NC

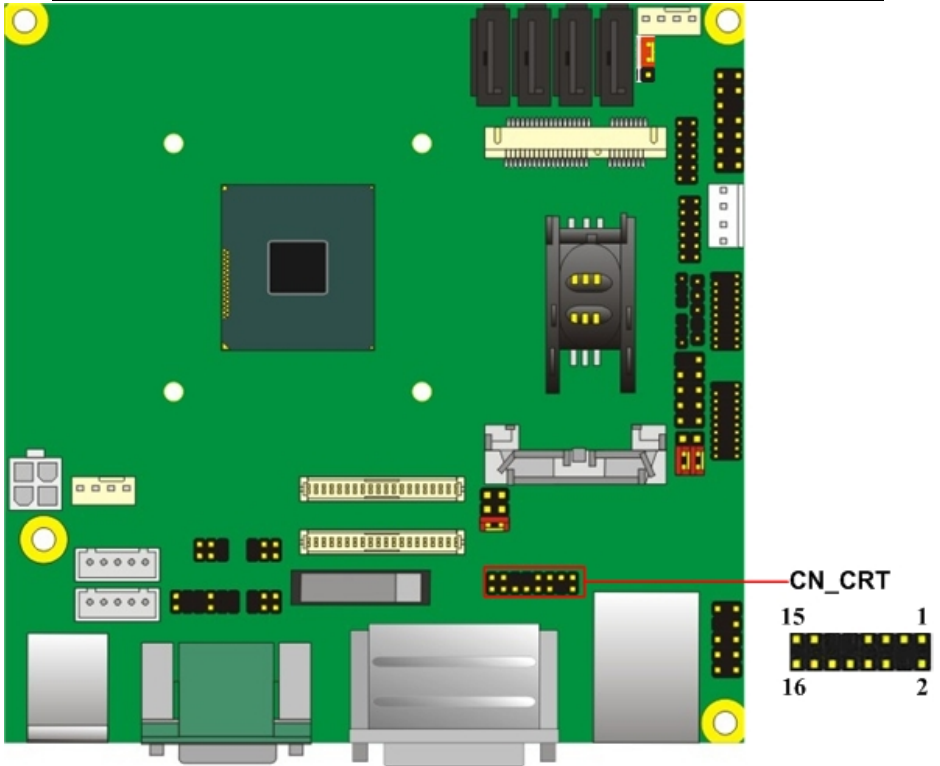

2.8 <Integrated Audio Interface>

The board integrates onboard audio interface with REALTEK ALC262 code, with Intel next generation of audio standard as High Definition Audio, it offers more vivid sound and other advantages than former HD audio compliance.

The main specifications of ALC262 are:

- **High-performance DACs with 100dB S/N ratio**

- 2 DAC channels support 16/20/24-bit PCM format for 2 audio solution
- Compatible with HD
- Meets Microsoft WHQL/WLP 2.0 audio requirements

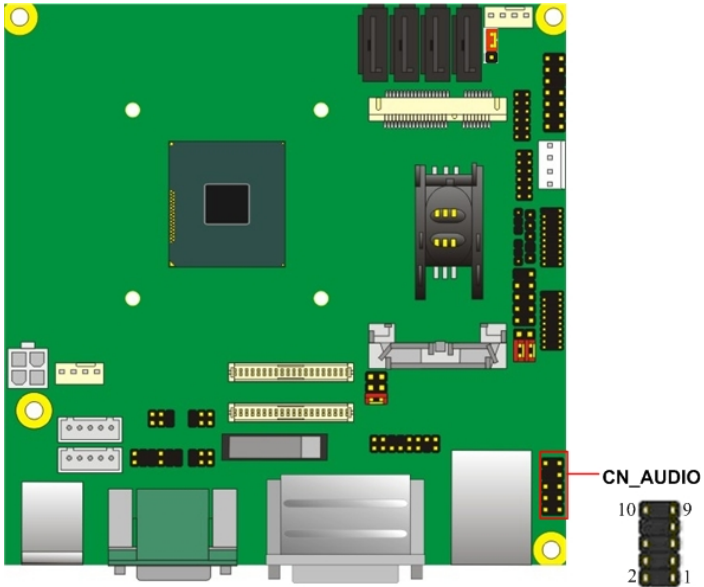

Connector: CN_AUDIO

Type: 10-pin (2 x 5) header (pitch = 2.54mm)

Pin	Description	Pin	Description
1	MIC_L	2	Ground
3	MIC_R	4	N/C
5	Speaker_R	6	MIC Detect
7	SENSE	8	N/C
9	Speaker_L	10	Speaker Detect

2.9 <USB Interface>

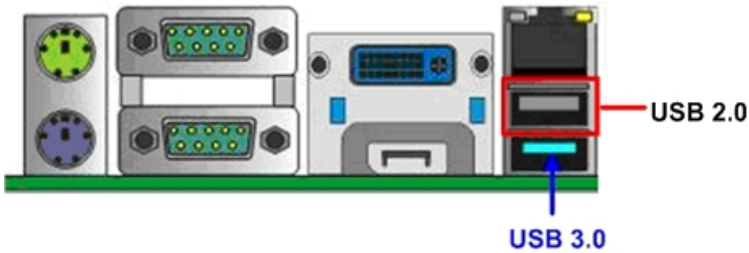

LN-D70 integrates 1 x USB3.0 / 2.0 and 3 x USB2.0 , The specifications of USB3.0 are listed below:

Interface	USB3.0
Transfer Rate	Up to 5Gb/s
Voltage	5V

The USB3.0 port need to Install **USB 3.0 eXtensible Host Controller Driver** and enable **xHCI Mode**.

2.9.1 < USB 3.0 eXtensible Host Controller Driver install >

Step1. Copy the USB 3.0 driver from “Driver CD” to the local hard driver directory.
(**Do not run this driver from a USB storage device**)

Step2. Configure default BIOS, click Advanced > South Cluster Configuration > USB Configuration, disable “**EHCI Mode**”.

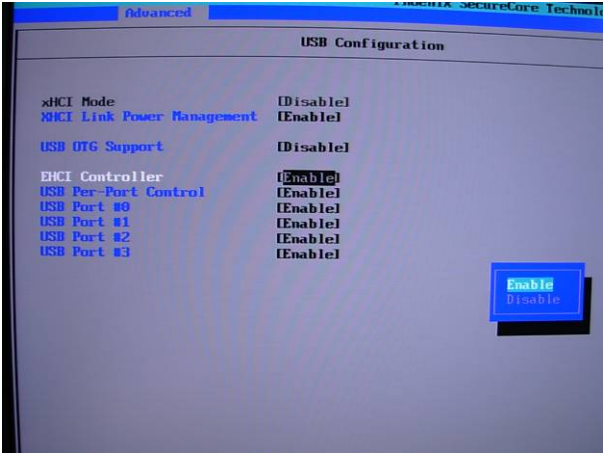

Step3. enable “xHCI Mode” and push “F10” to save configuration. Restart your computer.



Step4. If you enable xHCI Mode , USB 2.0 and USB 3.0 ports can't use without drive. We recommend that you connect PS/2 mouse / keyboard installing USB 3.0 driver.

Step5. Double click the “Setup.exe” from the directory. Click “Next” to continue.



Step6. Lastly, the “Setup Complete” screen appears so click “Finish” to restart your computer.



The specifications of USB2.0 are list:

Interface	USB2.0
Transfer Rate	Up to 480Mb/s
Voltage	5V

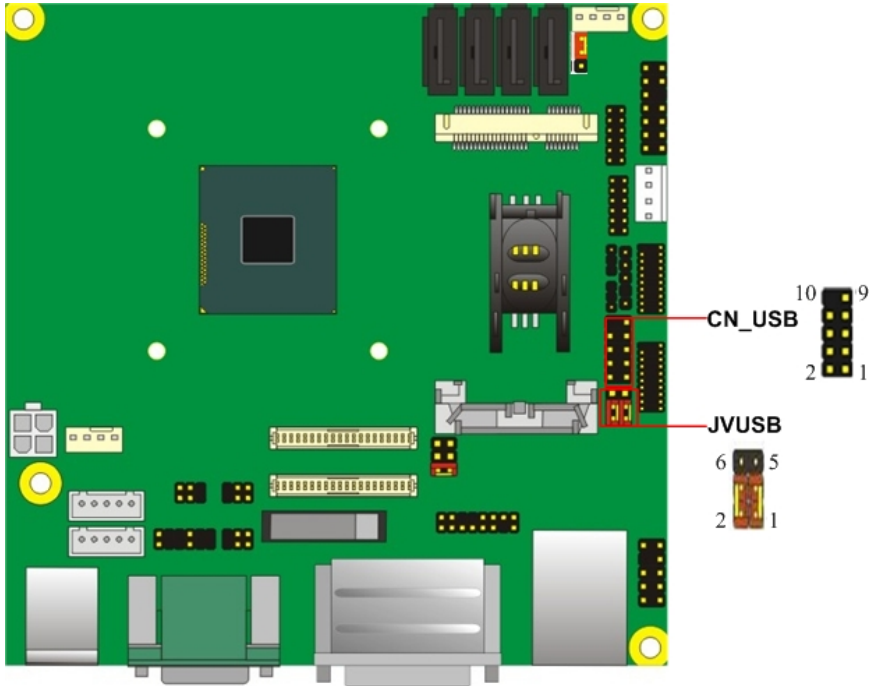

Connector: **CN_USB**

Type: 10-pin (2 x 5) header (pitch = 2.54mm)

Pin	Description	Pin	Description
1	VCC (5V_SB/ 5V)	2	VCC (5V_SB/ 5V)
3	Data0-	4	Data1-
5	Data0+	6	Data1+
7	Ground	8	Ground
9	Ground	10	N/C

CN_USB need to **enable xHCI Mode**.

Connector: **JVUSB**

Type: 6-pin Power select jumper

Pin	Description
1-3 & 2-4	5V_SB
3-5 & 4-6	5V

Default: 1-3 & 2-4

Effective patterns of connection: 1-3 & 2-4 or 3-5 & 4-6



Warning: others cause damages

2.10 <Serial Port>

The board supports four RS232 serial port and one jumper selectable RS232/422/485 serial ports. The jumper JCSEL1 & JCSEL2 can let you configure the communicating modes for COM2.

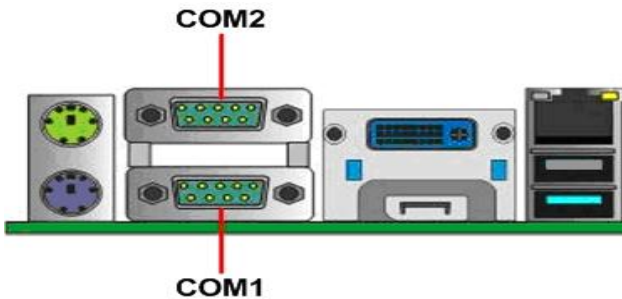

Connector: **COM1**

Type: 9-pin D-sub male connector on bracket for COM1

Pin	Description	Pin	Description
1	DCD	2	RXD
3	TXD	4	DTR
5	GND	6	DSR
7	RTS	8	CTS
9	RI	10	N/C

Connector: **COM2**

Type: 9-pin D-sub male connector on bracket for COM2

Pin	Description	Pin	Description
1	DCD/422TX-/485-	2	RXD/422TX+/485+
3	TXD/422RX+	4	DTR/422RX-
5	GND	6	DSR
7	RTS	8	CTS
9	RI	10	N/C

Setting RS-232 & RS-422 & RS-485 for COM2

Connector: **COM3/4, COM5/6**

Type: 20-pin (2 x 10) header pitch = 2.54x1.27mm

Pin	Description	Pin	Description
1	DCD1	2	RXD1
3	TXD1	4	DTR1
5	GND1	6	DSR1
7	RTS1	8	CTS1
9	RI1	10	N/C
11	DCD2	12	RX2
13	TX2	14	DTR2
15	Ground	16	DSR2
17	RTS2	18	CTS2
19	RI2	20	N/C

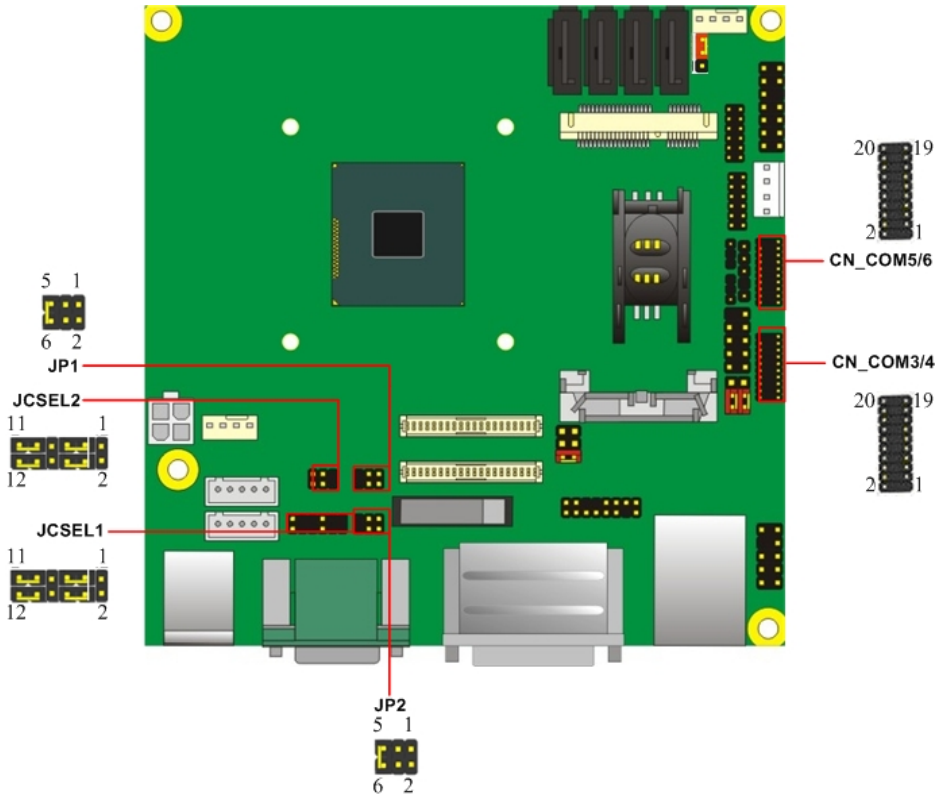

Function	JCSEL1	JCSEL2
RS-422		
RS-485		
RS-232 (Default)		

Default setting:

JCSEL1: (1-3, 2-4, 7-9, 8-10) JCSEL2: (1-2)

Jumper: **JP1/JP2 (COM1/2)**

Type: onboard 6-pin header

Power Mode	JP1/2
Pin 9 with 5V Power	1-2
Pin 9 with 12V Power	3-4
Standard COM port	5-6 Default setting

2.11 <PCIE Mini Card and SIM Interface>

The board provides a PCIE mini card sockets and a SIM socket.

MINI_CARD is the Mini-PCIE slot for long size Mini-PCIE cards and supports mSATA.

Connector: **SIMM (3G MiniPcie Model)**

Type: 6-pin SIM socket

Pin	Description	Pin	Description
1	SIMVCC	2	SIMRST
3	SIMCLK	4	NC

5	GND	6	SIMVPP
7	SIMDATA		

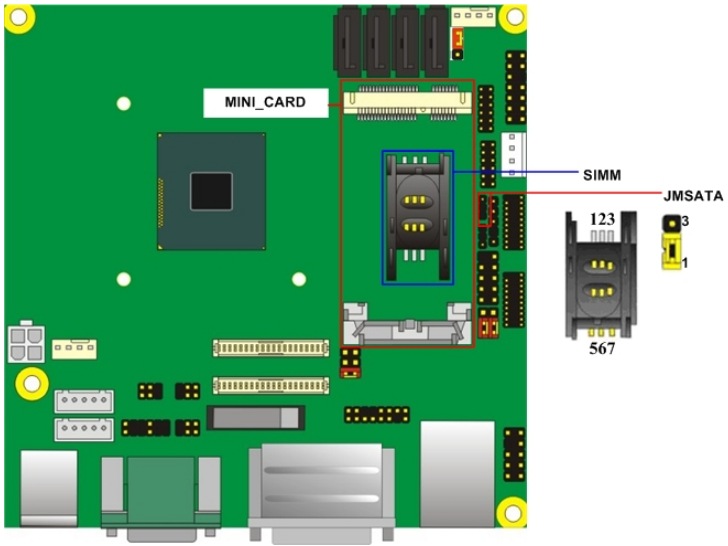

Jumper: **JMSATA**

Type: onboard 3-pin header

MINI_CARD Mode	JMSATA
Supply mSATA	1-2(Note)
MINI_CARD	2-3

Default setting: 2-3

Note:SATA2-2 and mSATA can't be enabled simultaneously

2.11.1 <SIM Setup>

Step1.

SIM card holder is marked by circle.

Slide the cap toward OPEN direction.

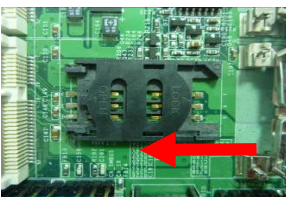

Step 2.

Make sure that the cap is now at the OPEN position.

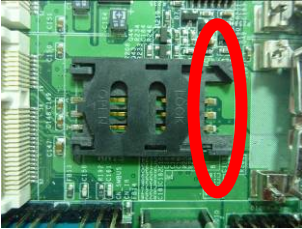

Step 3.

Flip the cap up for inserting a SIM card into.



Step 4.

Insert a SIM card as shown in the photo.

Be sure that the corner cut is on top and the golden pads are up.



Step 5.

Now, flip down the cap as shown in the photo.

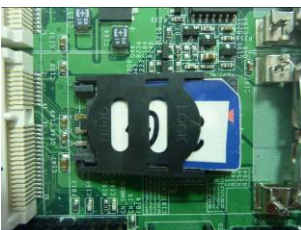

Step 6.

Press down and slide the cap to the CLOSE position. Be sure that the cap is tightly held with the socket.

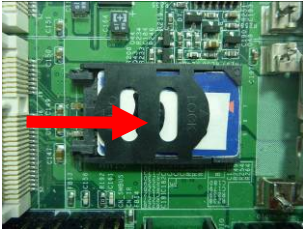

2.12 <GPIO and SMBUS Interface>

The board provides a programmable 8-bit digital I/O interface; you can use this general purpose I/O port for system control like POS or KIOSK. The GPIO is an **Open-drain output** and **TTL-level input**.

1. Output : **Open-drain**, Most applications **need use an external pull-up resistor**.
2. Input : **TTL-level**.

DC characteristics:

5V TTL-level Input Pin						
Parameter	Sym	Min	Typ	Max	Unit	Conditions
Input Low Voltage	V_{IL}			0.8	V	
Input High Voltage	V_{IH}	2.0			V	
Input High Leakage	I_{LIH}			+10	μA	$V_{IN} = 3.3V$
Input Low Leakage	I_{LIL}			-10	μA	$V_{IN} = 0V$
open-drain output pin with 12-mA sink capability						
Output Low Voltage	V_{OL}			0.4	V	$I_{OL} = 12\text{ mA}$

Connector: **CN_DIO**

Type: 12-pin (6 x 2) header (pitch = 2.0mm)

Pin	Description	Pin	Description
1	Ground	2	Ground
3	GPIO0	4	GPIO4
5	GPIO1	6	GPIO5
7	GPIO2	8	GPIO6
9	GPIO3	10	GPIO7
11	5V	12	12V

Connector: **CN_SMBUS**

Type: 5-pin header for SMBUS Ports

Pin	Description
1	VCC
2	N/C
3	SMBDATA
4	SMBCLK
5	Ground

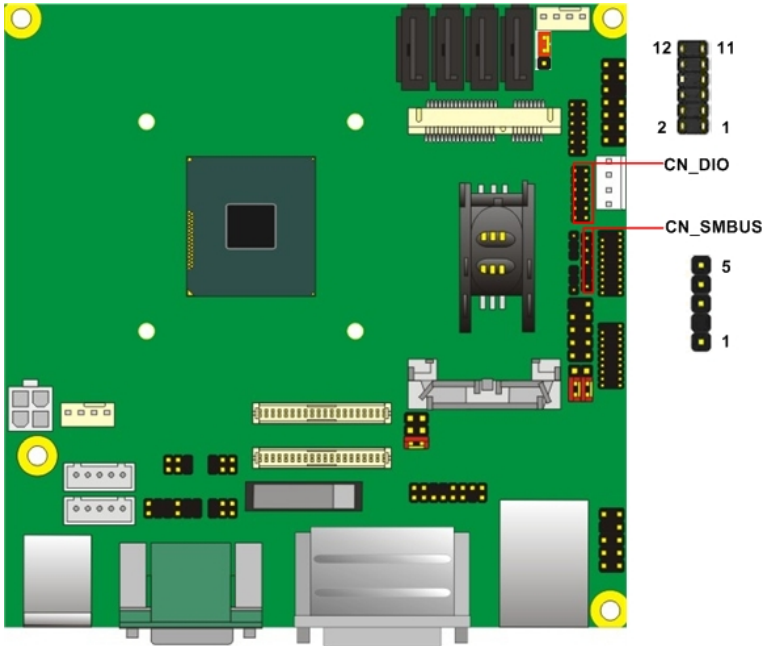

2.13 <Power Supply and Fan Interface >

2.13.1 <Power Input>

The board requires onboard 4-pin DC-input connector voltage range is from 6V to 24V, , for the input current, please take a reference of the power consumption report on appendix.

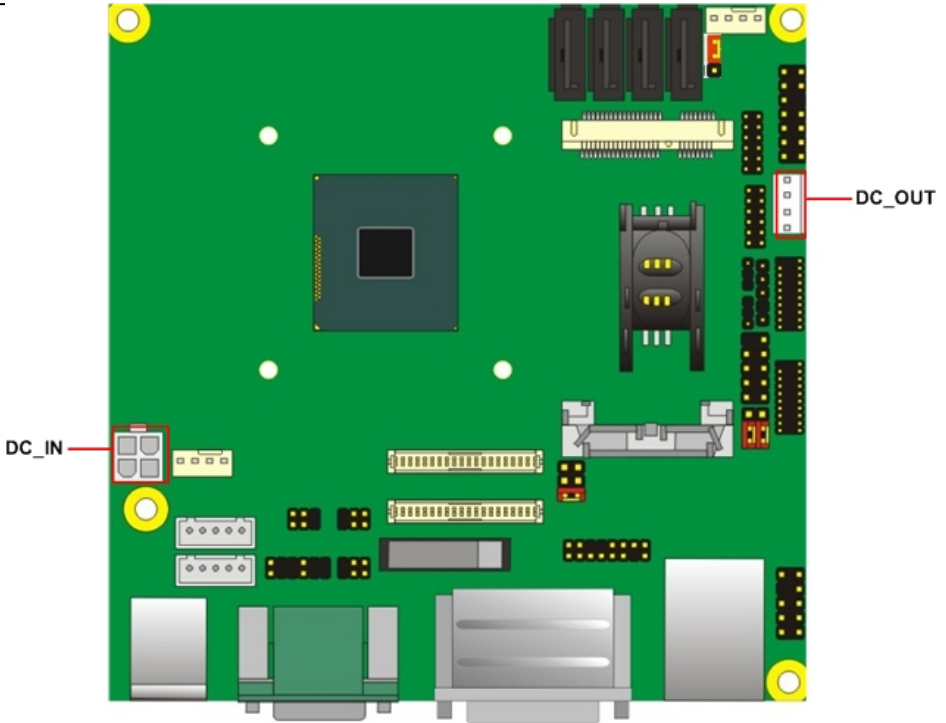

Connector: **DC_IN**

Type: 4-pin standard Pentium 4 additional +12V power connector

Pin	Description	Pin	Description
1	Ground	2	Ground
3	+6V~+24V	4	+6V~+24V

2.13.2 < Power Output >

Connector: **DC_OUT**

Type: 4-pin connector for +5V/+12V **output**

Pin	Description	Pin	Description	Pin	Description	Pin	Description
1	+12V	2	Ground	3	Ground	4	+5V

Note: Maximum output current 12V/3A, 5V/3A

2.13.3 <Fan connector>

The board provides one **4-pin** fan connectors supporting smart fan for CPU cooler and one **4-pin** cooler fan connectors for system.

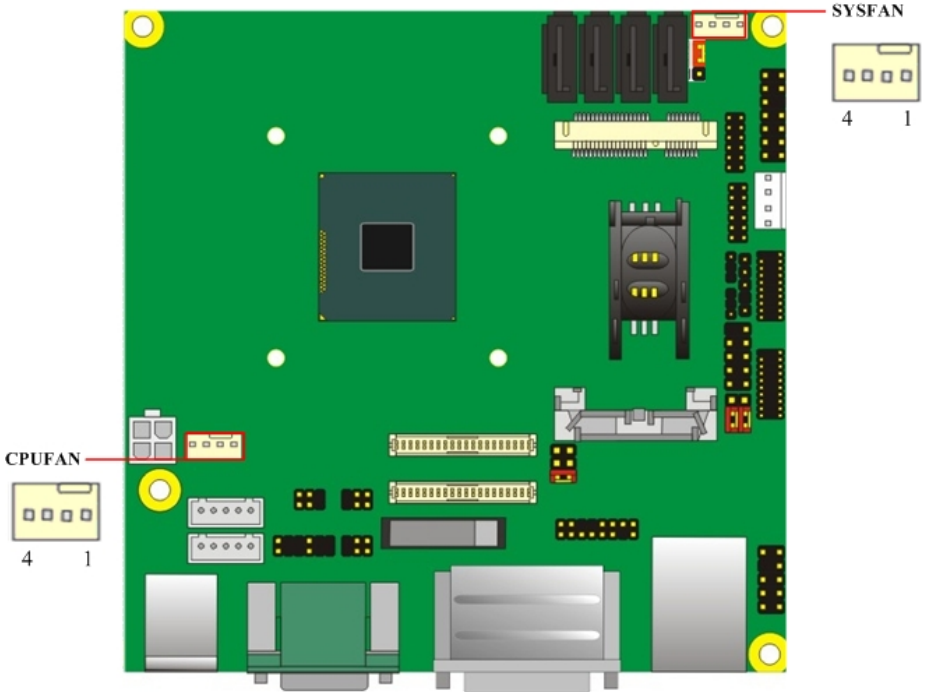

Connector: **CPUFAN**
 Type: 4-pin fan wafer connector

Pin	Description	Pin	Description
1	Ground	2	+12V
3	Fan Speed Detection	4	Fan Control

Connector: **SYSFAN**
 Type: 4-pin fan wafer connector

Pin	Description	Pin	Description
1	Ground	2	+12V
3	Fan Speed Detection	4	Fan Control

2.14 <Switch and Indicator>

The **JFRNT** provides front control panel of the board, such as power button, reset and beeper, etc. Please check well before you connecting the cables on the chassis.

Connector: **JFRNT**
 Type: onboard 14-pin (2 x 7) 2.54-pitch header

Function	Signal	PIN	Signal	Function
----------	--------	-----	--------	----------

IDE LED	HDLED+	1	2	PWRLED+	Power LED
	HDLED-	3	4	N/C	
Reset	Reset+	5	6	PWRLED-	Speaker
	Reset-	7	8	SPK+	
N/C		9	10	N/C	
Power	PWRBT+	11	12	N/C	
Button	PWRBT-	13	14	SPK-	

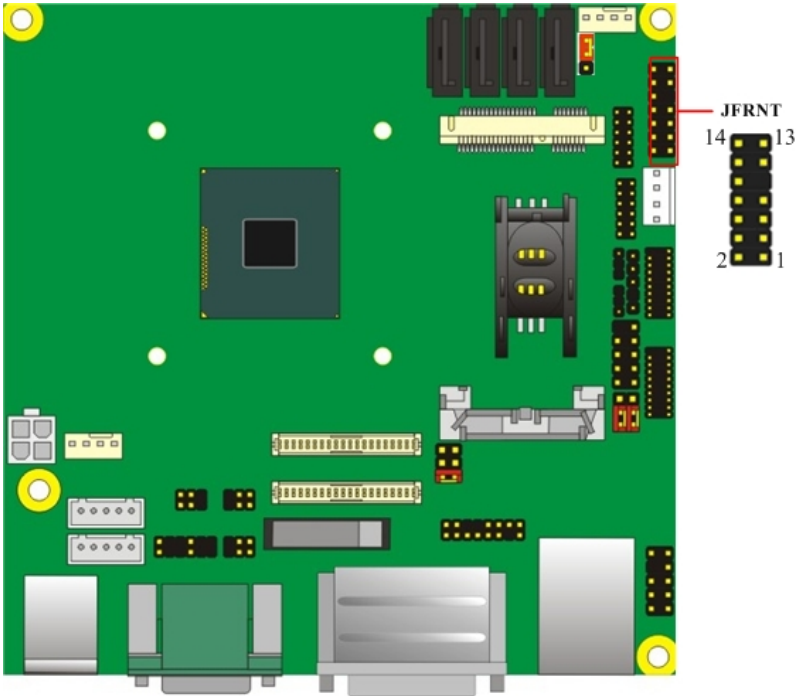

Chapter 3 <System Setup>

3.1 <Audio Configuration>

The board integrates REALTEK® ALC262 code. It can support 2-channel sound under system configuration. Please follow the steps below to setup your sound system.

1. Install REALTEK HD Audio driver.
2. Lunch the control panel and Sound Effect Manager.

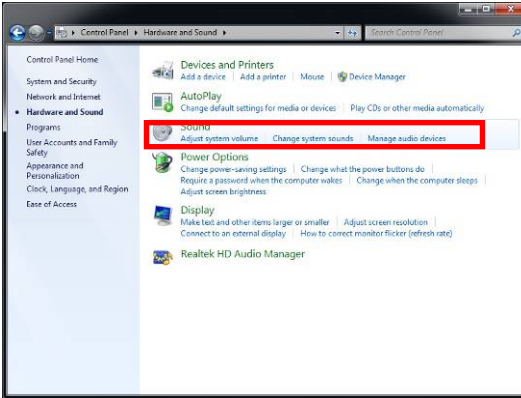

3. Select Speaker Configuration

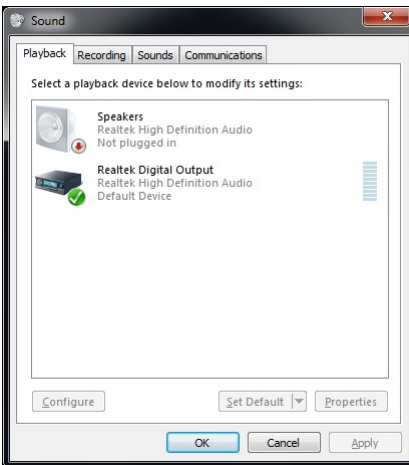

3.2 <Display Properties Setting>

Based on Intel J1900/N2930 with HD Graphic, the board supports two DACs for display device as different resolution and color bit.

Please install the Intel Graphic Driver before you starting setup display devices.

1. Click right button on the desktop to lunch **Screen resolution > Advanced settings**

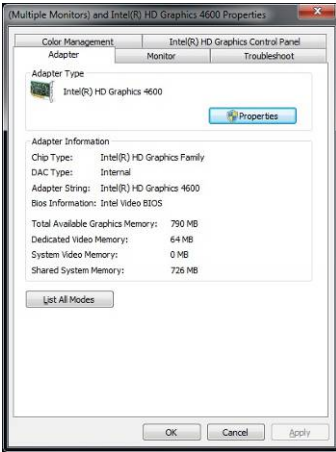

2. Click **Graphics Properties...** button for more specificity setup.

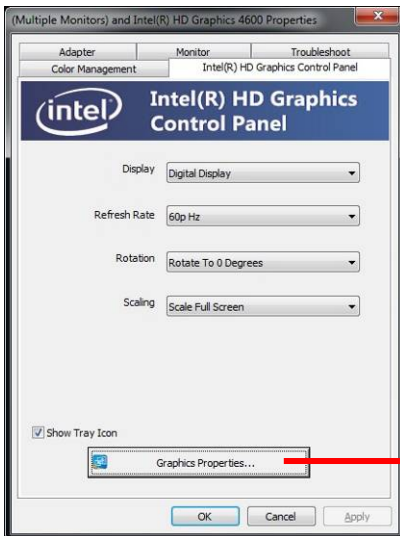

Click Graphics Properties... for advanced setup

3. This setup options can let you define each device settings.

Click **Display Settings** to setup the CRT monitor for Resolution and Refresh Rate

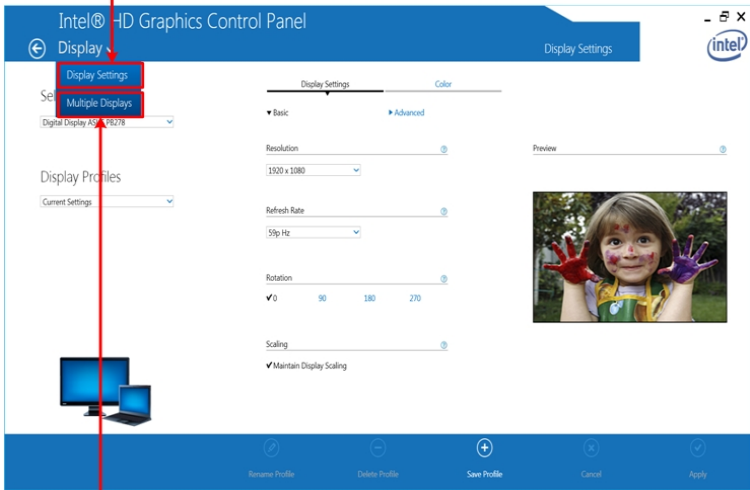

Click **Multiple Displays** to setup the dual display mode as same screen

3.3 <SATA configuration>

SATA Mode:

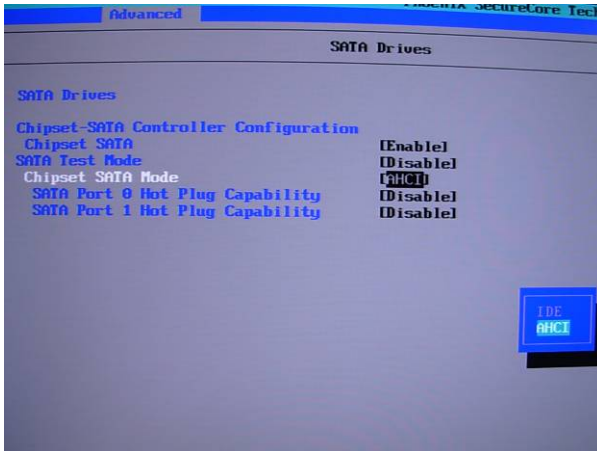

This option can let you select whether the Serial ATA hard drives would work under normal **IDE** or **AHCI**.

Chapter 4 <BIOS Setup>

The motherboard uses the Phoenix BIOS for the system configuration. The Phoenix BIOS in the single board computer is a customized version of the industrial standard BIOS for IBM PC AT-compatible computers. It supports Intel x86 and compatible CPU architecture based processors and computers. The BIOS provides critical low-level support for the system central processing, memory and I/O sub-systems.

The BIOS setup program of the single board computer let the customers modify the basic configuration setting. The settings are stored in a dedicated battery-backed memory, NVRAM, retains the information when the power is turned off. If the battery runs out of the power, then the settings of BIOS will come back to the default setting.

The BIOS section of the manual is subject to change without notice and is provided here for reference purpose only. The settings and configurations of the BIOS are current at the time of print, and therefore they may not be exactly the same as that displayed on your screen.

To activate CMOS Setup program, press key immediately after you turn on the system. The following message "Press DEL to enter SETUP" should appear in the lower left hand corner of your screen. When you enter the CMOS Setup Utility, the Main Menu will be displayed as **Figure 4-1**. You can use arrow keys to select your function, press <Enter> key to accept the selection and enter the sub-menu.

Figure 4-1 CMOS Setup Utility Main Screen

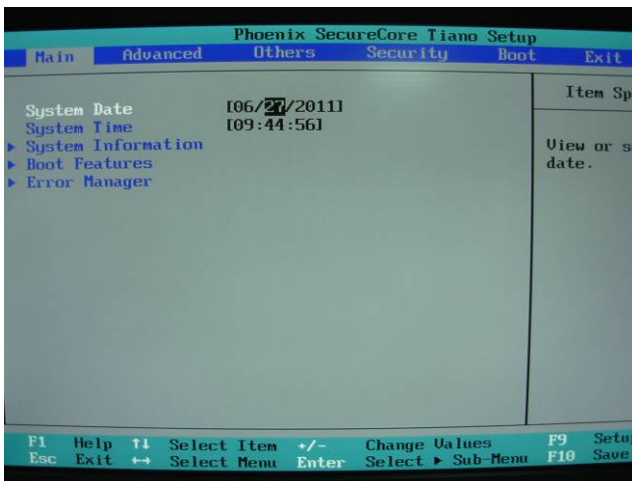

Appendix A <I/O Port Pin Assignment>

A.1 <Serial ATA Port>

Connector: **SATA1/2**

Type: 7-pin wafer connector

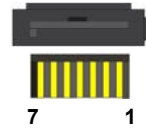

1	2	3	4	5	6	7
GND	RSATA_TXP1	RSATA_TXN1	GND	RSATA_RXN1	RSATA_RXP1	GND

A.2 <LAN Port>

Connector: **RJ45**

Type: RJ45 connector with LED on bracket

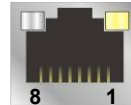

Pin	1	2	3	4	5	6	7	8
Description	MI0+	MI0-	MI1+	MI2+	MI2-	MI1-	MI3+	MI3-

A.3 <LPC Port>

Connector: **CN_LPC**

Type: 10-pin header for LPC Port

Pin	Description	Pin	Description
1	LPC_CLK	2	RESET-
3	-LFRAME	4	LAD3
5	LAD2	6	LAD1
7	LAD0	8	+3.3V
9	SERIRQ	10	Ground
11	3.3V	12	N/C

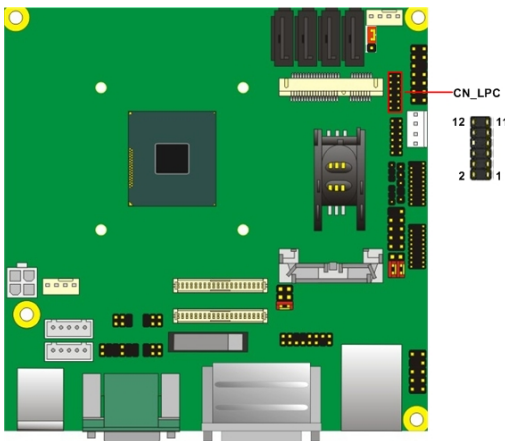

Appendix B <Flash BIOS>

B.1 <Flash Tool>

The board is based on Phoenix BIOS and can be updated easily by the BIOS auto flash tool. You can download the tool online from below link

<http://www.commell.com/Support/Product%20Technical%20Support/LN-D70.htm>

B.2 <Flash BIOS Procedure>

- 1.Extract the zip file(re-flash tool and BIOS file) to root of the USB flash drive.
- 2.Insert your USB flash drive in USB port of the board and power on the system.
3. Boot to EFI-Shell mode (**UEFI Boot Enable, Legacy Boot Disable**)

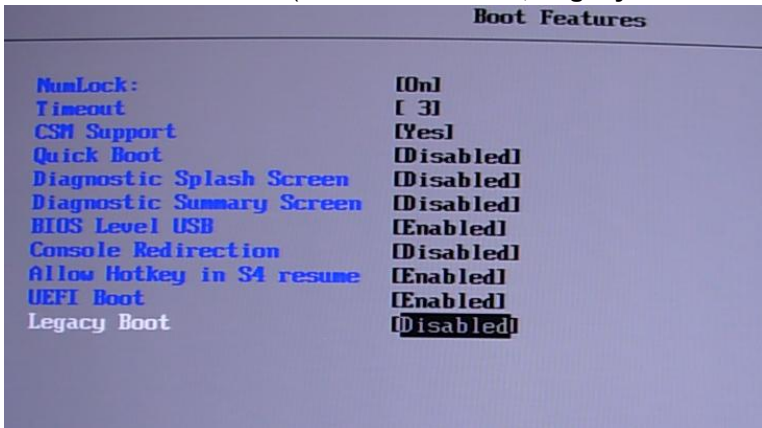

then input the “**fs0:**” command to switch to the root of the USB flash drive.

```

Device mapping table
fs0 :Removable HardDisk - Alias hd31a0d0b blk0
     Acpi (PNP0A03,0) /Pci (1D10) /Usb (0,0) /Usb (3,0) /HD (Part1.Sig0001624F)
blk0 :Removable HardDisk - Alias hd31a0d0b fs0
     Acpi (PNP0A03,0) /Pci (1D10) /Usb (0,0) /Usb (3,0) /HD (Part1.Sig0001624F)
blk1 :HardDisk - Alias (null)
     Acpi (PNP0A03,0) /Pci (1310) /Sata (0,0,0) /HD (Part1.SigD002A069)
blk2 :HardDisk - Alias (null)
     Acpi (PNP0A03,0) /Pci (1310) /Sata (0,0,0) /HD (Part2.SigD002A069)
blk3 :HardDisk - Alias (null)
     Acpi (PNP0A03,0) /Pci (1310) /Sata (0,0,0) /HD (Part3.SigD002A069)
blk4 :BlockDevice - Alias (null)
     Acpi (PNP0A03,0) /Pci (1310) /Sata (0,0,0)
blk5 :Removable BlockDevice - Alias (null)
     Acpi (PNP0A03,0) /Pci (1D10) /Usb (0,0) /Usb (3,0)

Press ESC in 1 seconds to skip startup.nsh, any other key to continue.
hell> fs0: _

```

4. Type the " **fpt64.efi -y -f xxx.bin**" command to start flash BIOS processes. (xxx.bin means the BIOS file that you want to update)
5. When it finished all update processes, restart the system.

Any question about the BIOS re-flash please contact your distributors or visit the web-site at below:

<http://www.commell.com.tw/support/support.htm>

Appendix C <Programming GPIO's>

The GPIO' can be programmed with the MSDOS debug program using simple IN/OUT commands. The following lines show an example how to do this. (The GPIO is open drain)

GPIO0.....GPIO7 bit0.....bit7

```

-o 4E 87 ;enter configuration
-o 4E 87
-o 4E 07
-o 4F 07 ;enale GPIO function
-o 4E 30
-o 4F 10 ;enable GPIO configuration
-o 4E F0
-o 4F xx ;set GPIO as input/output; set '1' for input,'0'for
output

```

-o 4E F1

-o 4F xx ;if set GPIO's as output,in this register its value can be set

Optional :

-o 4E F2

-o 4F xx ; Data inversion register ; '1' inverts the current value of the bits , '0' leaves them as they are

-o 4E 30

-o 4F 01 ; active GPIO's

For further information, please refer to NCT6106D datasheet.

Appendix D <Programming Watchdog Timer >

The watchdog timer makes the system auto-reset while it stops to work for a period.

The integrated watchdog timer can be setup as system reset mode by program.

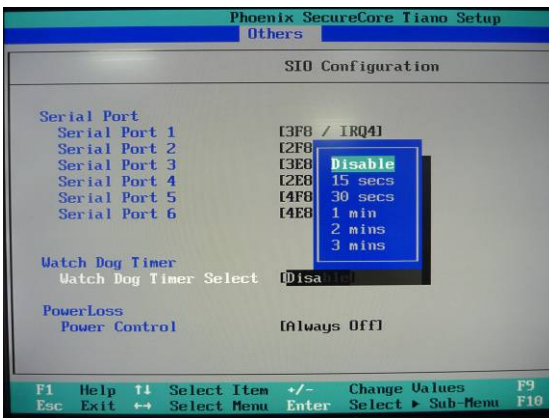

Timeout Value Range

- 1 to 255
- Second or Minute

Program Sample

The integrated Watchdog Timer can be set up by programming.

- O 4E 87 Enter configuration
- O 4E 87

-O 4E 07	Logic Device Enable
-O 4F 08	
-O 4E 30	WDT Enable
-O 4F 01	
-O 4E F0	Set as Second*
-O 4F 00	
-O 4E F1	
-O 4F 0A	Set reset time 10 Sec

You can select Timer setting in the BIOS, after setting the time options, the system will reset according to the period of your selection.

Contact Information

Any advice or comment about our products and service, or anything we can help you please don't hesitate to contact with us. We will do our best to support you for your products, projects and business.

Taiwan Commate Computer Inc.

Address	19F., No.94, Sec. 1, Xintai 5th Rd., Xizhi Dist., New Taipei City 22102, Taiwan
TEL	+886-2-26963909
FAX	+886-2-26963911
Website	http://www.commell.com.tw
E-Mail	info@commell.com.tw (General Information) tech@commell.com.tw (Technical Support)
Facebook	https://www.facebook.com/pages/Taiwan-Commate-Computer-Inc/547993955271899
Twitter	https://twitter.com/Taiwan_Commate

Commell is a brand name of Taiwan commate computer Inc.