

ME-C79

Micro ATX Motherboard

User's Manual

Edition 1.0

2014/02/21

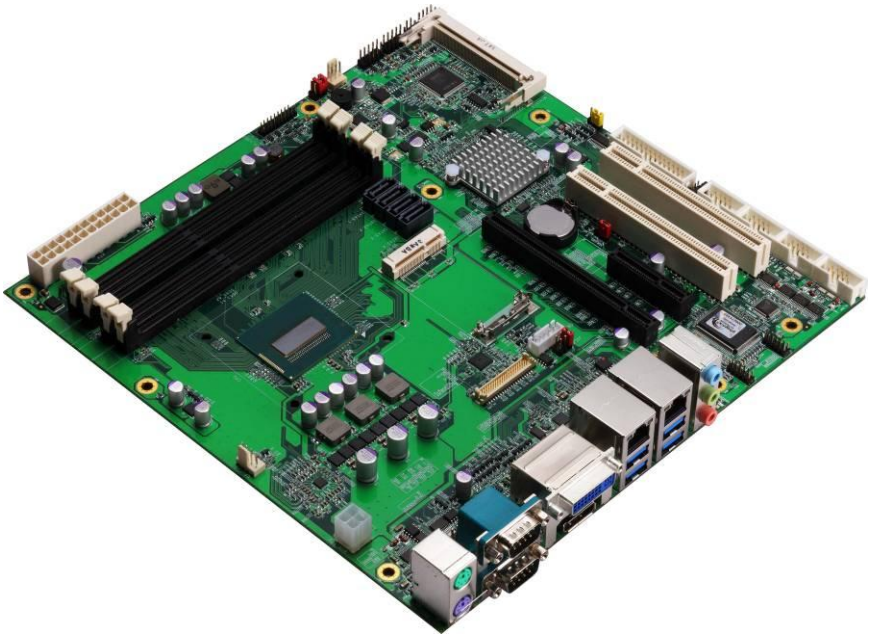

Copyright

Copyright 2014, all rights reserved. This document is copyrighted and all rights are reserved. The information in this document is subject to change without prior notice to make improvements to the products.

This document contains proprietary information and protected by copyright. No part of this document may be reproduced, copied, or translated in any form or any means without prior written permission of the manufacturer.

All trademarks and/or registered trademarks contains in this document are property of their respective owners.

Disclaimer

The company shall not be liable for any incidental or consequential damages resulting from the performance or use of this product.

The company does not issue a warranty of any kind, express or implied, including without limitation implied warranties of merchantability or fitness for a particular purpose.

The company has the right to revise the manual or include changes in the specifications of the product described within it at any time without notice and without obligation to notify any person of such revision or changes.

Trademark

All trademarks are the property of their respective holders.

Any questions please visit our website at <http://www.commell.com.tw>

Packing List:

Please check the package content before you starting using the board.

Hardware:

ME-C79 Micro ATX motherboard x 1 (include Cooler Fan)

Cable Kit:



SATA Cable x 2
(1040529)

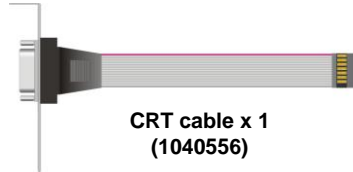

CRT cable x 1
(1040556)

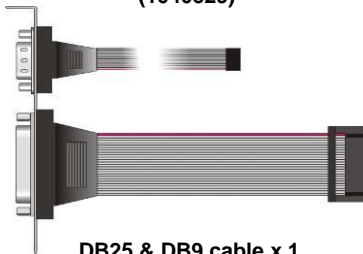

DB25 & DB9 cable x 1

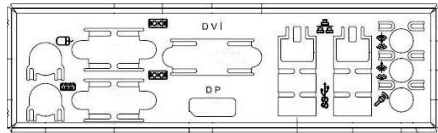

I/O Shield x 1
(OPLATE-MCDLA)
(1270055)

Printed Matters:

Driver CD (Including User's Manual) x 1

Optional :

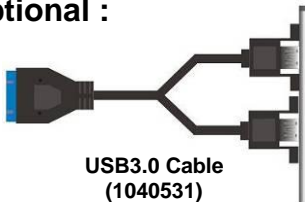

USB3.0 Cable
(1040531)

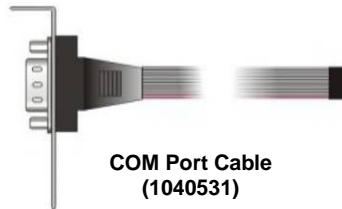

COM Port Cable
(1040531)

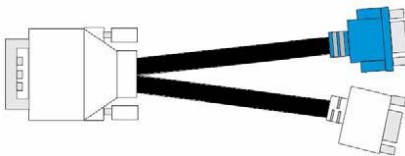

DVI VGA Cable x 1
(1040078)

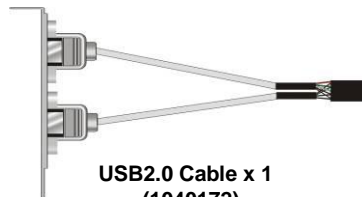

USB2.0 Cable x 1
(1040172)

Index

Chapter 1 <Introduction>	1
1.1 <Product Overview>	1
1.2 <Product Specification>.....	2
1.3 <Mechanical Drawing>.....	3
1.4 <Block Diagram>.....	4
Chapter 2 <Hardware Setup>	5
2.1 <Connector Location>	5
2.2 <Jumper Location & Reference>.....	6
2.3 <Connector Reference>	7
2.3.1 <Internal Connectors>	7
2.3.2 <External Connectors>	7
2.4 <Memory Setup>	8
2.5 <CMOS & ATX Setup>	9
2.6 <Serial ATA Interface>	10
2.7 <Ethernet Interface>.....	11
2.8 <Onboard Display Interface>.....	12
2.8.1 <External Display>.....	12
2.8.2 <Internal Display>	13
2.9 <Integrated Audio Interface>	18
2.10 <USB Interface>	19
2.11 <Serial Port>.....	21
2.12 <Mini PCI Card and mSATA Interface>	24
2.13 <GPIO and SMBUS Interface>.....	25
2.14 <Power Supply and Fan Interface >	26
2.14.1 <Power Input>.....	26
2.14.2 <Fan connector>.....	27
2.15 <Switch and Indicator>.....	28
Chapter 3 <System Setup>	29
3.1 <Audio Configuration>.....	29

3.2 <Display Properties Setting>	30
3.3 <SATA configuration>	32
3.4 <SATA RAID Configuration>.....	33
Chapter 4 <BIOS Setup>	35
Appendix A <I/O Port Pin Assignment>	37
A.1 <Serial ATA Port>	37
A.2 <IrDA Port>	37
A.3 <LAN Port>	37
A.4 <LPC Port>	37
Appendix B <Flash BIOS>	38
B.1 <Flash Tool>	38
B.2 <Flash BIOS Procedure>.....	38
Appendix C <Programming GPIO's>	39
Appendix D <Programming Watchdog Timer >	40
Contact Information	41

(This page is left for blank)

Chapter 1 <Introduction>

1.1 <Product Overview>

ME-C79 the 4th Generation Intel of Micro ATX motherboard, supports 4th Generation Intel® Core™ i7, Core™ i5, Core™ i3, Celeron Mobile Processor and features Intel DH82QM87 chipset, integrated HD Graphics, DDR3L memory, REALTEK High Definition Audio, Serial ATA with AHCI and RAID function for a system and Intel Gigabit LAN.

Intel Haswell Bridge Processor

The 4th Generation Intel® Core™ processor family mobile is the next generation of 64-bit, multi-core mobile processor built on 22- nanometer process technology. Based on a new micro-architecture.

New features for Intel DH82QM87 chipset

The DH82QM87 chipset provides better CPU, graphics, media performance, flexibility and more enhanced security that is suitable for a variety of intelligent systems the ideal choice.

All in One multimedia solution

Based on Intel DH82QM87 chipset, the board provides high performance onboard graphics, CRT, 24-bit dual channel LVDS interface, DisplayPort, DVI and 2.1 channels High Definition Audio, to meet the very requirement of the multimedia application.

Flexible Extension Interface

The board provides one PCIe x16, one PCIe x4, two PCI, one mini PCI and one mSATA.

1.2 <Product Specification>

General Specification

Form Factor	Micro ATX motherboard
CPU	4th Generation Intel® Core™ i7, Core™ i5, Core™ i3, Celeron® Mobile Processor Package. Type: FCBGA1364
Memory	4 x DDR3L DIMM 1333/1600 MHz up to 32GB Support Non-ECC, unbuffered memory only
Chipset	Intel® DH82QM87 PCH
Real Time Clock	Chipset integrated RTC with onboard lithium battery
Watchdog Timer	Generates a system reset with internal timer for 1min/s ~ 255min/s
Power Management	Supports ACPI 4.0 compliant
Serial ATA Interface	4 x serial ATA3 interface with 600MB/s transfer rate (Only for SATA3) Support RAID 0, 1, 5, 10 and Intel Rapid Storage Technology
Display Interface	Intel® 4th Generation Core mobile processor integrated HD Graphics 4600 1 x CRT (Onboard 2x8 pin-header) 1 x DVI (Rear I/O Port) 1 x DisplayPort (Rear I/O Port) 1 x LVDS (Onboard 24-bit dual channel connector with +3.3/+5/+12V supply)
Audio Interface	Realtek ALC888 HD Audio
LAN Interface	1 x Intel® I210-AT Gigabit LAN 1 x Intel® I217-LM Gigabit LAN (Support iAMT9.0)
GPIO Interface	Onboard programmable 12 pin-header, 8-bit Digital I/O interface
Extended Interface	1 x PCIe x16 slot, 1 x PCIe x4 slot, 2 x PCI slot , 1 x mini PCI slot, 1 x mSATA(Only for SATA3)
Internal I/O Port	4 x RS232, 1 x SMBUS, 1 x GPIO, 2 x USB3.0, 4 x USB2.0, 1 x IrDA, 1 x CRT, 1 x LVDS, 1 x LCD inverter, 1 x LPC, 4 x Serial ATA3 , 1 x Parallel port and 1 x Front panel Audio
External I/O Port	1 x PS/2, 2 x LAN, 1 x DVI, 1 x DisplayPort, 4 x USB3.0, 1 x RS232/422/485, 1 x RS232, and 1 x HD Audio
Power Requirement	Standard 24-pin ATX power supply (20-pin is compatible) and P4 4-pin 12V
Dimension	244mm x 244mm
Temperature	Operating within 0~60 centigrade Storage within -20~85 centigrade

Ordering Code

ME-C7917L	i7-4700EQ Mobile Processor , Onboard CRT, LVDS, DVI, DisplayPort, SATA3, USB2.0, USB3.0, HD Audio ,LAN , SMBUS, LPC, GPIO, IrDA, PS/2, mini PCI, mSATA, LPT.
ME-C7917P	Celeron 2002E Mobile Processor , Onboard CRT, LVDS, DVI, DisplayPort, SATA3, USB2.0, USB3.0, HD Audio ,LAN , SMBUS, LPC, GPIO, IrDA, PS/2, mini PCI, mSATA, LPT.

The specifications may be different as the actual production.

For further product information please visit the website at <http://www.commell.com.tw>.

1.4 <Block Diagram>

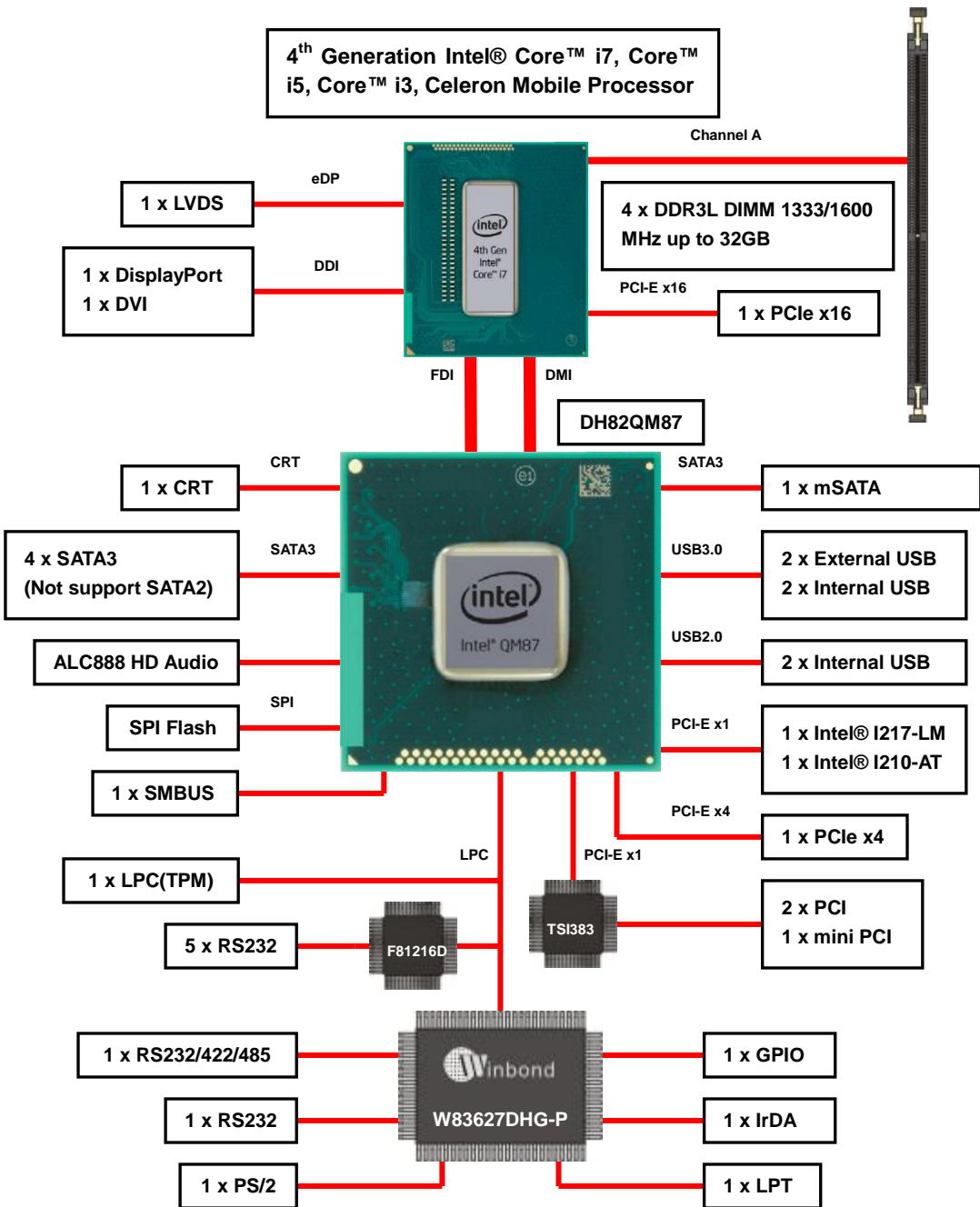

Chapter 2 <Hardware Setup>

2.1 <Connector Location>

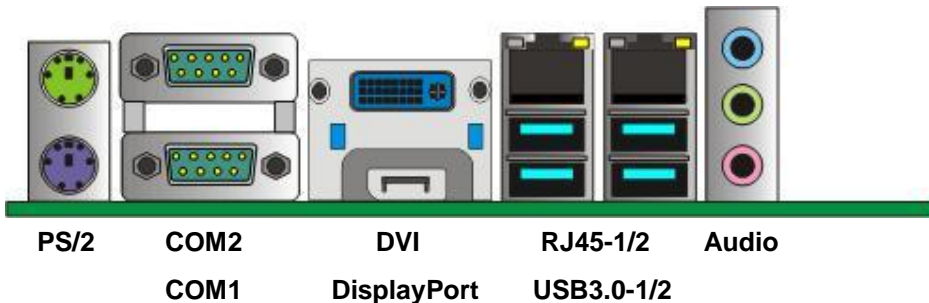
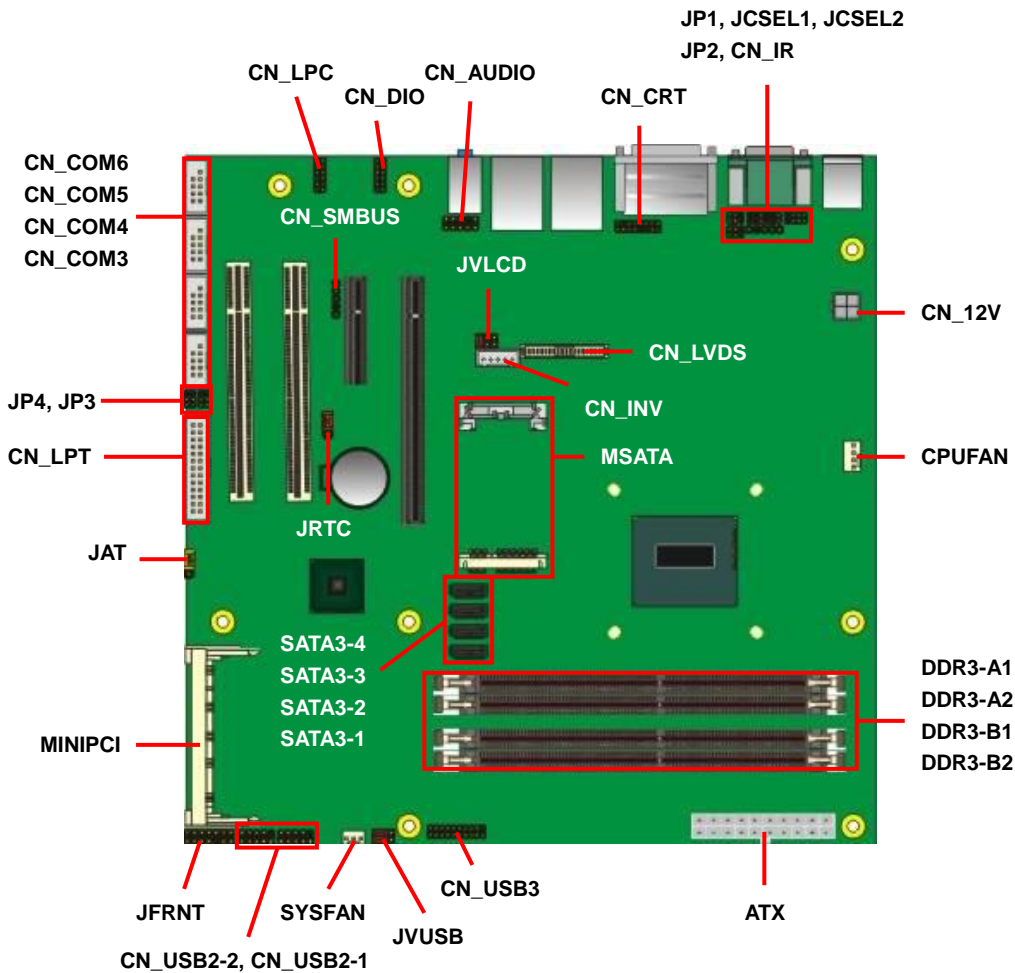

2.2 <Jumper Location & Reference>

Jumper	Function
JRTC	CMOS Operating/Clear Setting
JVLCD	Panel Voltage Setting
JAT	Power mode select
JP1	Com1 Voltage Setting (For Pin 9)
JP2	Com2 Voltage Setting (For Pin 9)
JP3	Com2 Voltage Setting (For Pin 9)
JP4	Com2 Voltage Setting (For Pin 9)
JCSEL1	CN_COM2 RS-232 RS422 RS485 Setting
JCSEL2	CN_IR IrDA Setting
JVUSB	USB Voltage Setting

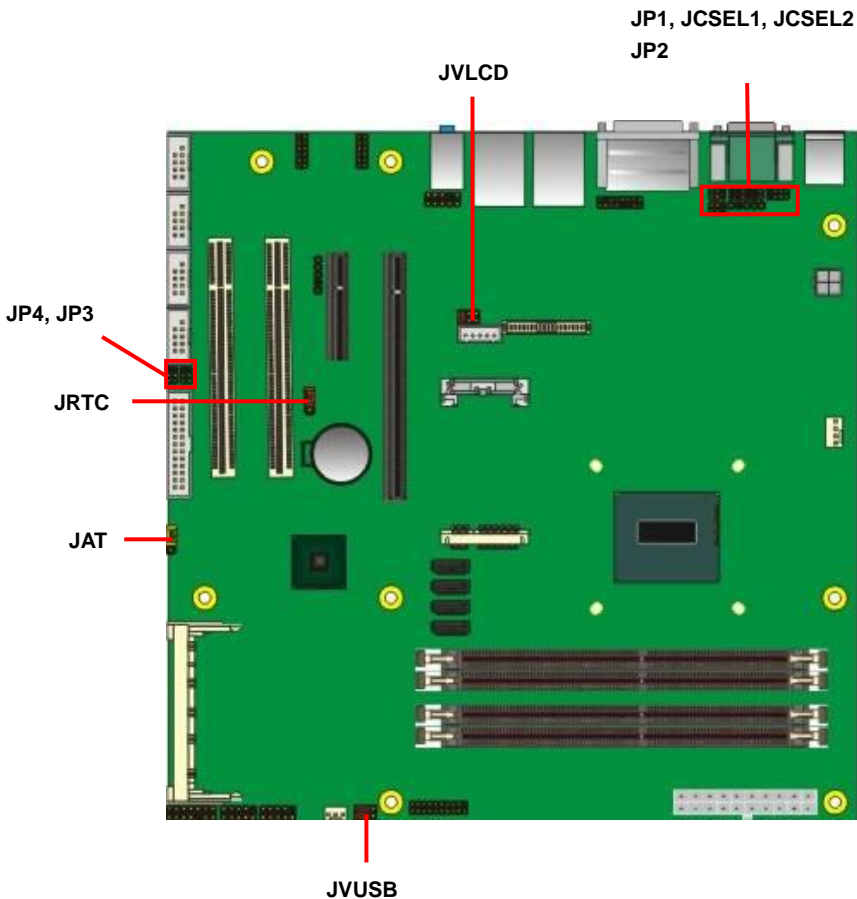

2.3 <Connector Reference>

2.3.1 <Internal Connectors>

Connector	Function	Remark
CPU	FCBGA 1364 CPU	
DDR3-A/B	240-pin DDR3L DIMM slot	
SATA3-1/2/3/4	7-pin Serial ATA3 connector	
CN_12V	DC 12V input connector	
ATX	24-pin power input connector	
CN_AUDIO	5 x 2-pin audio connector	
CN_DIO	6 x 2-pin digital I/O connector	
CN_USB2	5 x 2-pin USB2.0 connector	
CN_USB3-1/2	10 x 2-pin USB3.0 connector	
CPUFAN	4-pin CPU cooler fan connector	
SYSFAN	3-pin System cooler fan connector	
CN_CRT	8 x 2-pin CRT connector	
CN_LVDS	20 x 2-pin LVDS connector	
CN_INV	5-pin LCD inverter connector	
CN_IR	5-pin IrDA connector	
CN_COM1/2	19-pin RS232/485/422 for COM2	
CN_COM3/4, 5/6	10 x 2-pin RS232	
CN_LPC	6 x 2-pin LPC connector	
CN_SMBUS	5-pin SMBUS connector	
JFRNT	7 x 2-pin front panel switch/indicator connector	
MSATA	52-pin Mini-PCIe slot	
MINIPCI	124-pin MiniPCI slot	
CN_LPT	13 x 2 printer connector	
PCIe x16	164-pin x16 PCIe slot	
PCIe x4	64-pin x4 PCIe slot	
PCI 1/2	120-pin PCI slot	

2.3.2 <External Connectors>

Connector	Function	Remark
DisplayPort + DVI	20-pin DisplayPort and 24+5-pin DVI connector	
COM1/2	DB9 Serial port connector	
PS/2	PS/2 keyboard and mouse connector	
USB_RJ45-1/2	2 x USB3.0 and 1 x RJ45 LAN connector	
AUDIO	Audio connector	

2.4 <Memory Setup>

The board provides 4 x 240-pin DDR3L DIMM to support 1333/1600MHz up to 32GB.
Support Non-ECC, unbuffered memory only.

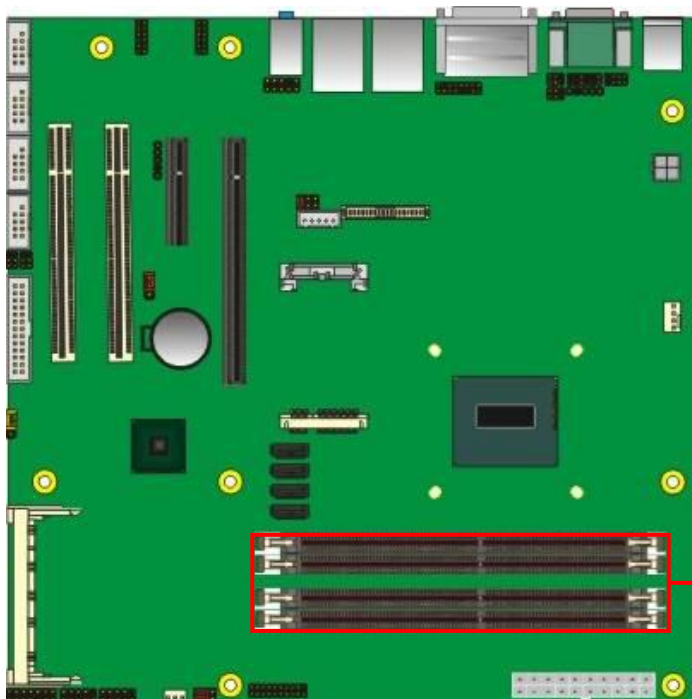

DDR3-A1
DDR3-A2
DDR3-B1
DDR3-B2



Please check the pin number to match the socket side well
before installing memory module.

2.5 <CMOS & ATX Setup>

The board's data of CMOS can be setting in BIOS. If the board refuses to boot due to inappropriate CMOS settings, here is how to proceed to clear (reset) the CMOS to its default values.

Jumper: JRTC

Type: Onboard 3-pin jumper

JRTC	Mode
1-2	Clear CMOS
2-3	Normal Operation

Default setting: 2-3

Jumper: JAT

Type: Onboard 3-pin jumper

JAT	Mode
1-2	AT Mode
2-3	ATX Mode

Default setting:2-3

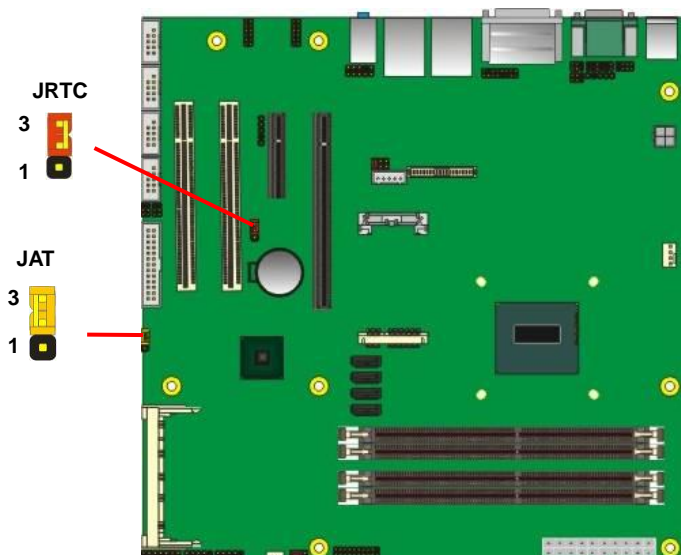

2.6 <Serial ATA Interface>

ME-C79 has Four Serial ATA 3 interfaces with RAID function, the transfer rate of the Serial ATA 3 can be up to 600MB/s. Please go to <http://www.serialata.org/> for more about Serial ATA technology information. The main features on Intel® QM87 PCH are listed below:

1. Optimizing performance of the computer, the reaction speed and reliability
2. Intel® Smart Response Technology for fast access to frequently used files and applications.
3. Superior performance and data protection: RAID technology
4. Dynamic Storage Accelerator release SSD performance power
5. Intel® Rapid Recover Technology provides fast data recovery
6. Lower power consumption and more excellent performance and flexibility

Based on Intel® PCH, it supports **Intel® Rapid Storage Technology** with combination of RAID 0,1,5 and 10.

1. Supports for up to RAID volumes on a single, two-hard drive RAID array.
2. Supports for Serial ATA ATAPI devices.
3. Supports for RAID spares and automatic rebuild.
4. Supports on RAID arrays, including NCQ and native hot plug.

For more information please visit Intel's official website.

For more about the system setup for Serial ATA, please check the chapter of SATA configuration.

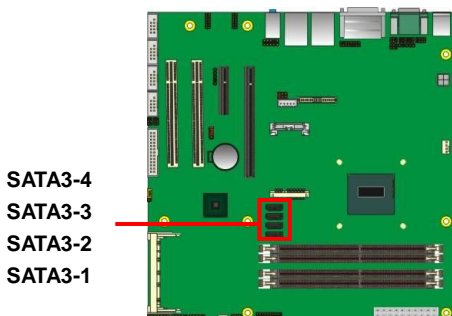

2.7 <Ethernet Interface>

The board integrates with one Intel® I210-AT Gigabit Ethernet & Intel® I217-LM controllers, The Intel Gigabit Ethernet supports triple speed of 10/100/1000Base-T, with IEEE802.3 compliance.

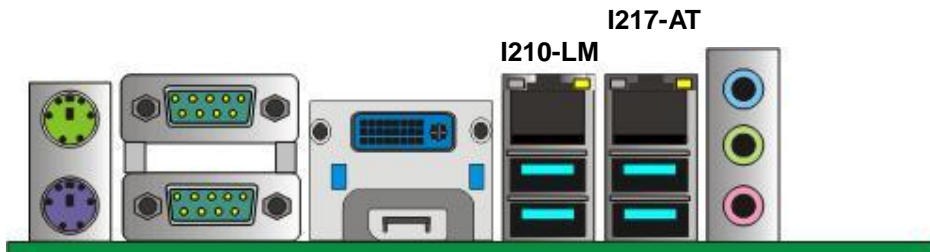

Onboard Intel® I217-LM GbE controller support Intel® AMT 9.0 feature on primary LAN port. The BIOS is ready to support Intel® AMT 9.0 feature. The necessary prerequisite is your CPU must support Intel® vPro technology, ex. [i7-4700EQ](#)

For further instruction about the Intel® AMT features and set up, please refer to the [iAMT Setting.pdf](#).

2.8 <Onboard Display Interface>

Based on Intel **Haswell Bridge** CPU with built-in HD Graphic, the board provide one DVI and one DisplayPort on the external I/O port, one 40-pin LVDS interface with 5-pin LCD backlight inverter connector, one internal 16-pin CRT connector interface .

The board provides triple display function with clone mode and extended desktop mode for DVI, DisplayPort, CRT and LVDS.

2.8.1 <External Display>

Please connect your monitor which supports DVI or DisplayPort to connect onboard rear I/O Port.

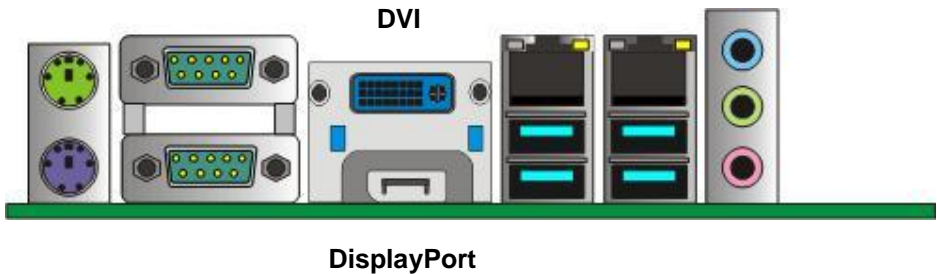

2.8.2 <Internal Display>

The board provides one 16-pin CRT and 40-pin LVDS connector for 24-bit single/dual channel panels, the LVDS supports up to 2048 x 1536 (UXGA) resolution, with one LCD backlight inverter connector and one jumper for panel voltage setting.

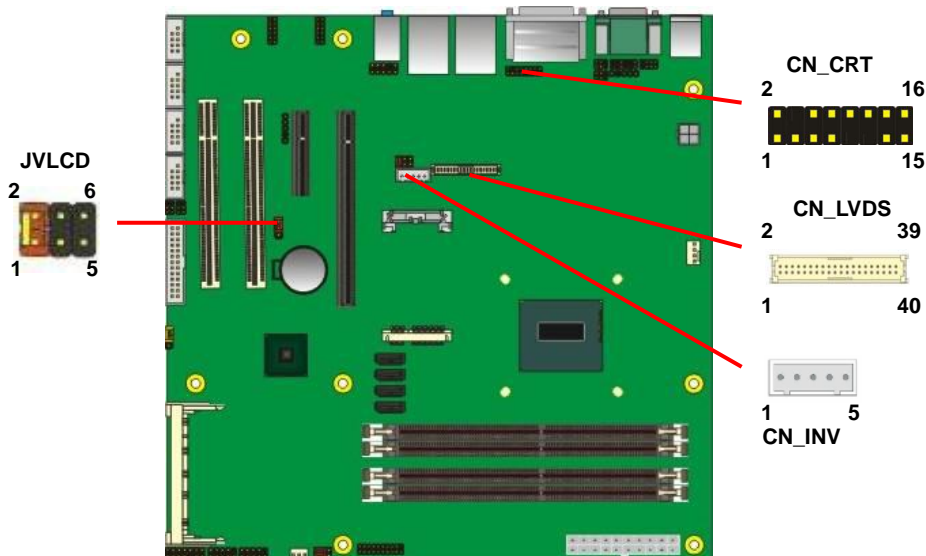

Effective patterns of connection: 1-2 / 3-4 / 5-6



Warning: others cause damages

Connector: **CN_CRT**

Connector type: 16-pin header connector (pitch = 2.00mm)

Pin Number	Assignment	Pin Number	Assignment
1	BR	2	BG
3	BB	4	NC
5	-CRTATCH	6	IOGND1
7	IOGND1	8	IOGND1
9	NC	10	-CRTATCH
11	NC	12	5VCD A
13	5HSYNC	14	5VSYNC
15	5VCLK	16	NC

 Connector: **CN_INV**

Type: 5-pin LVDS Power Header

Pin	Description
1	+12V
2	Reserved (Note)
3	GND
4	GND
5	ENABKL

Note: Reserved for MB internal test
Please treat it as NC.

 Connector: **JVLCD**

Type: 6-pin Power select Header

Pin	Description
1-2	LCDVCC (3.3V)
3-4	LCDVCC (5V)
5-6	LCDVCC (12V)

Default: 1-2

Connector: **CN_LVDS**

Type: onboard 40-pin connector

Connector model:

E&T 3950-B40C-00R or similar (**HIROSE DF13-40DP-1.25V** compatible)

Pin	Signal	Pin	Signal
2	LCDVCC	1	LCDVCC
4	GND	3	GND
6	ATX0-	5	BTX0-
8	ATX0+	7	BTX0+
10	GND	9	GND
12	ATX1-	11	BTX1-
14	ATX1+	13	BTX1+
16	GND	15	GND
18	ATX2-	17	BTX2-
20	ATX2+	19	BTX2+
22	GND	21	GND
24	ACLK-	23	BTX3-
26	ACLK+	25	BTX3+
28	GND	27	GND
30	ATX3-	29	BCLK-
32	ATX3+	31	BCLK+
34	GND	33	GND
36	DDCPCLK	35	SMBCKL
38	DDCPDATA	37	SMBDATA
40	N/C	39	SPDIFO

To setup the LCD, you need the component below:

1. A panel with LVDS interfaces.
2. An inverter for panel's backlight power.
3. A LCD cable and an inverter cable.

For the cables, please follow the pin assignment of the connector to make a cable, because every panel has its own pin assignment, so we do not provide a standard cable; please find a local cable manufacture to make cables.

LCD Installation Guide:

1. Preparing the **ME-C79, LCD panel** and the **backlight inverter**.

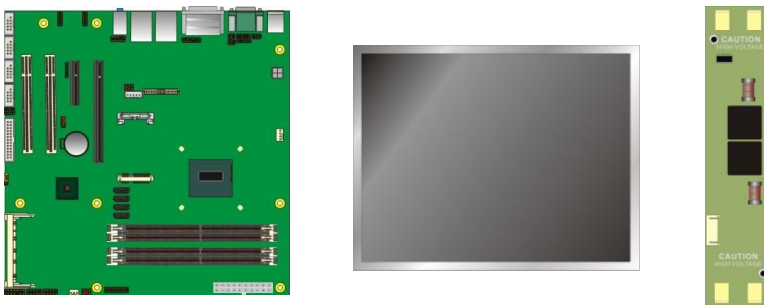

2. Please check the datasheet of the panel to see the voltage of the panel, and set the jumper **JVLCD** to +12V or +5V or +3.3V.
3. You would need a LVDS type cable.

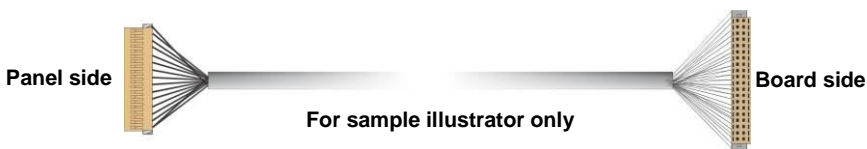

4. To connect all of the devices well.

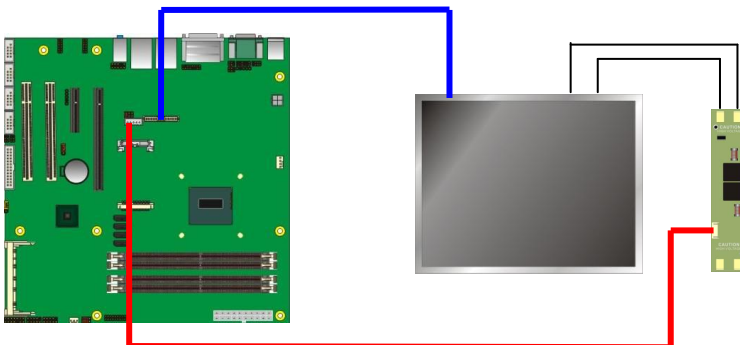

After setup the devices well, you need to select the LCD panel type in the BIOS.

The panel type mapping is list below:

BIOS panel type selection form (BIOS Version:1.0)			
Single / Dual channel		Single / Dual channel	
NO.	Output format	NO.	Output format
1	640 x 480	9	1680 x 1050
2	800 x 600	10	1920 x 1200
3	1024 x 768	11	1440 x 900
4	1280 x 1024	12	1024 x 768
5	1400 x 1050 Reduced Blanking	13	1280 x 1024
6	1400 x 1050 non-Reduced Blanking	14	1280 x 800
7	1680 x 1200	15	1920 x 1080
8	1366 x 768	16	2048 x 1536

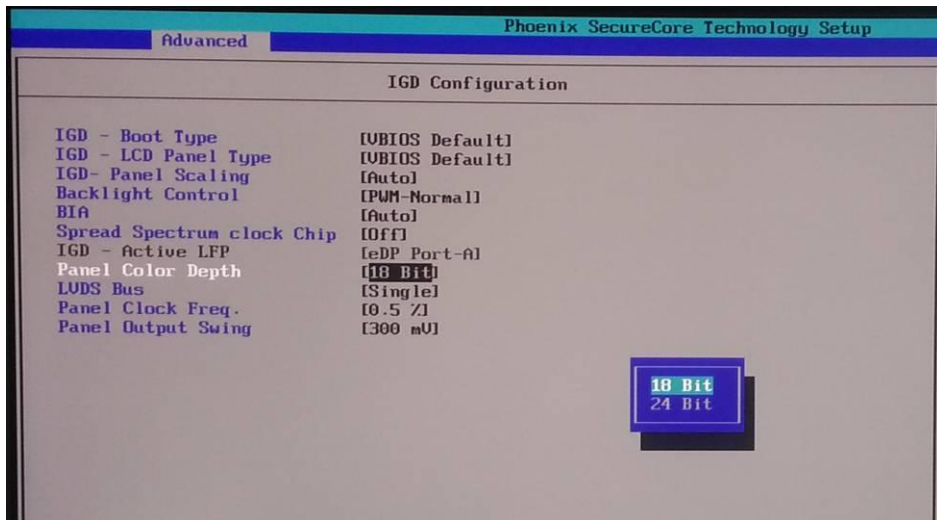

2.9 <Integrated Audio Interface>

The board provides the onboard high definition audio with Realtek ALC888

Connector: CN_AUDIO

Type: 10-pin (2 x 5) 1.27mm x 2.54mm-pitch header



Pin	Description	Pin	Description
1	MIC_L	2	Ground
3	MIC_R	4	N/C
5	Speaker_R	6	MIC Detect
7	SENSE	8	N/C
9	Speaker_L	10	Speaker Detect

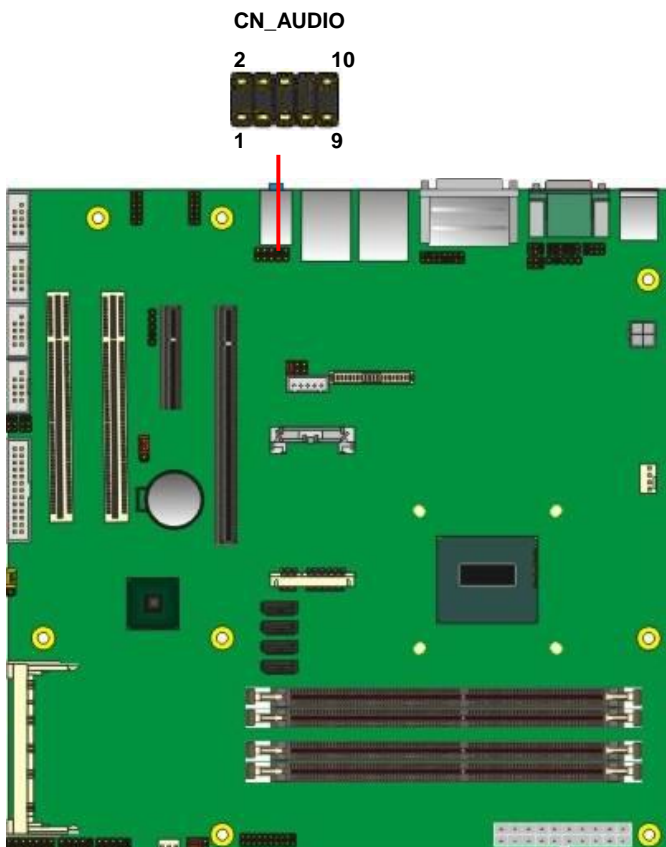

2.10 <USB Interface>

ME-C79 integrates two internal USB3.0 ports and four internal USB2.0 ports.

The specifications of USB3.0 are listed below:

Interface	USB3.0
Controller	Intel®QM87
Transfer Rate	Up to 5Gb/s
Voltage	5V

The specifications of USB2.0 are list

Interface	USB2.0
Controller	Intel®QM87
Transfer Rate	Up to 480Mb/s
Voltage	5V

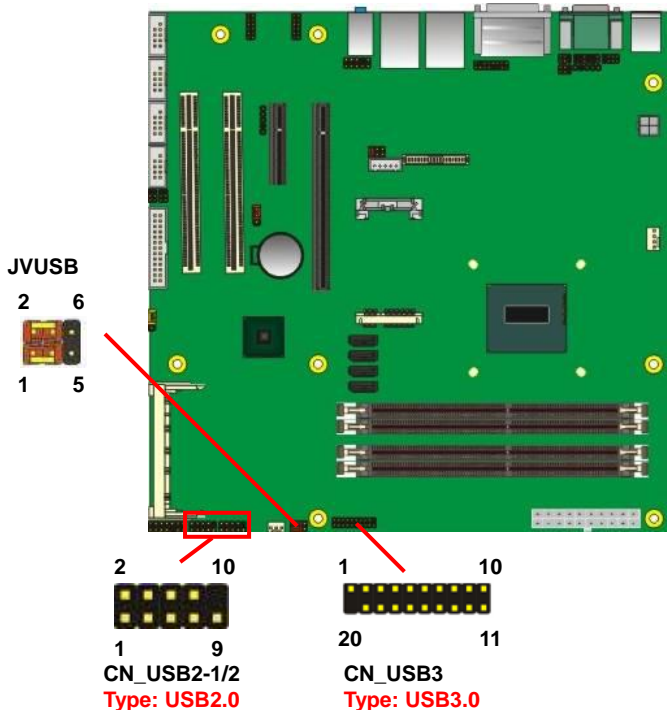

Connector: CN_USB3

Type: 20-pin (2 x 10) header (pitch = 2.0mm)

Pin	Description	Pin	Description
1	VCC	20	NC
2	USB3.0_RX0-	19	VCC
3	USB3.0_RX0+	18	USB3.0_RX1-
4	Ground	17	USB3.0_RX1+
5	USB3.0_TX0-	16	Ground
6	USB3.0_TX0+	15	USB3.0_TX1-
7	Ground	14	USB3.0_TX1+
8	Data0-	13	Ground
9	Data0+	12	Data1-
10	NC	11	Data1+

Connector: CN_USB2

Type: 10-pin (2 x 5) header (pitch = 2.54mm)

Pin	Description	Pin	Description
1	VCC	2	VCC
3	Data0-	4	Data1-
5	Data0+	6	Data1+
7	Ground	8	Ground
9	Ground	10	N/C

Connector: JVUSB

Type: 6-pin Power select jumper

Pin	Description
1-3 & 2-4	5V_SB
3-5 & 4-6	5V

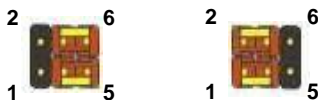
Default: 1-3 & 2-4
Effective patterns of connection: 1-3 & 2-4 or 3-5 & 4-6

Warning: others cause damages

2.11 <Serial Port>

The board supports five RS232 serial port and one jumper selectable RS232/422/485 serial ports. The jumper JCSEL1 & JCSEL2 can let you configure the communicating modes for COM2.



Connector: **COM1**

Type: 9-pin D-sub male connector on bracket for COM1

Pin	Description	Pin	Description
1	DCD	2	RXD
3	TXD	4	DTR
5	GND	6	DSR
7	RTS	8	CTS
9	RI	10	N/C

Connector: **COM2**

Type: 9-pin D-sub male connector on bracket for COM2

Pin	Description	Pin	Description
1	DCD/422TX-/485-	2	RXD/422TX+/485+
3	TXD/422RX+	4	DTR/422RX-
5	GND	6	DSR
7	RTS	8	CTS
9	RI	10	N/C

Setting RS-232 & RS-422 & RS-485 for COM2









Connector: **COM3/4, 5/6**

Type: 20-pin(2 x 10)header pitch = 2.54 x 1.27mm

Pin	Description	Pin	Description
1	DCD1	2	RXD1
3	TXD1	4	DTR1
5	GND1	6	DSR1
7	RTS1	8	CTS1
9	RI1	10	N/C
11	DCD2	12	RXD2
13	TXD2	14	DTR2
15	GND2	16	DSR2
17	RTS2	18	CTS2
19	RI2	20	N/C

 Jumper: **JCSEL1,JCSEL2**

Type: 12-pin (6 x 2) & 8-pin (4 x 2) for set COM2 mode jumper

	RS232	RS485	RS422	IrDA
JCSEL1				
JCSEL2				

Default: RS232

 Jumper: **JP1/JP2/JP3/JP4 (COM1/2/3/4)**

Type: onboard 6-pin header

Power Mode	JP1/2
Pin 9 with 5V Power	1-2
Pin 9 with 12V Power	3-4
Standard COM port	5-6
Default setting (5-6)	

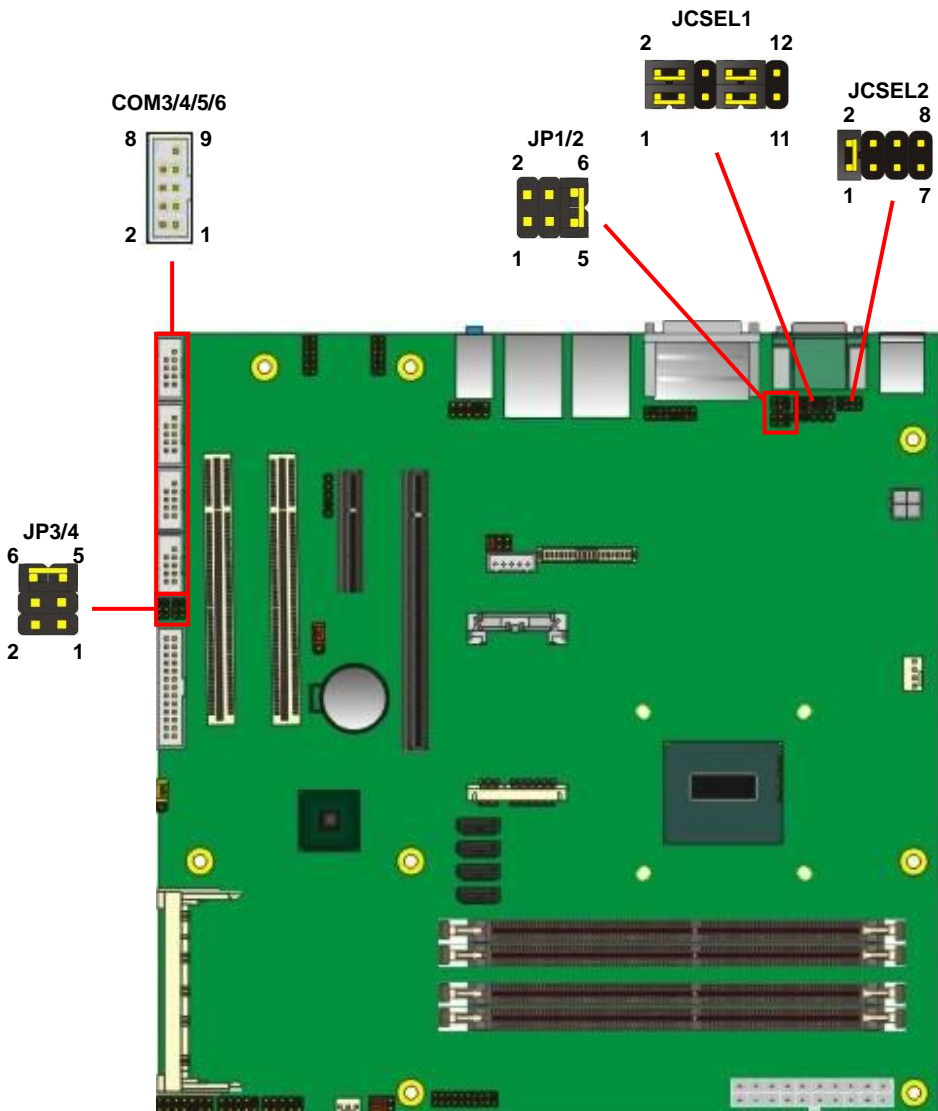

2.12 <Mini PCI Card and mSATA Interface>

The board provides one Mini PCI card and one mSATA slot.

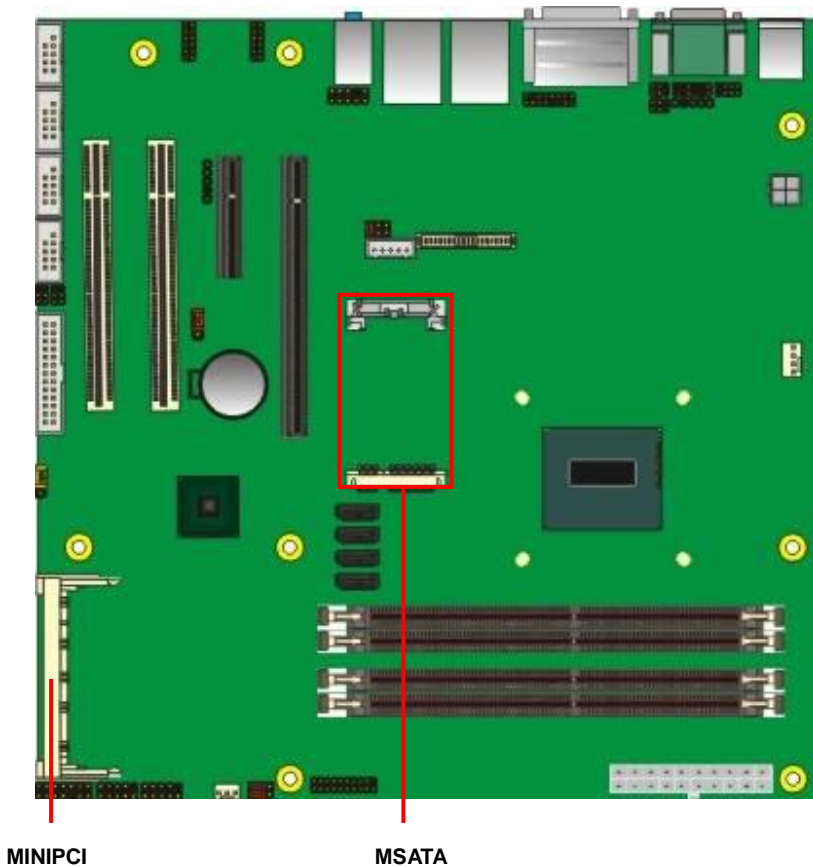

2.13 <GPIO and SMBUS Interface>

The board provides a programmable 8-bit digital I/O interface; you can use this general purpose I/O port for system control like POS or KIOSK.

Connector: **CN_DIO**

Type: 12-pin (6 x 2) header (pitch = 2.0mm)

Pin	Description	Pin	Description
1	Ground	2	Ground
3	GP10	4	GP14
5	GP11	6	GP15
7	GP12	8	GP16
9	GP13	10	GP17
11	5V	12	12V

Connector: **CN_SMBUS**

Type: 5-pin header for SMBUS Ports

Pin	Description
1	VCC
2	N/C
3	SMBDATA
4	SMBCLK
5	Ground

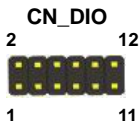

CN_SMBUS

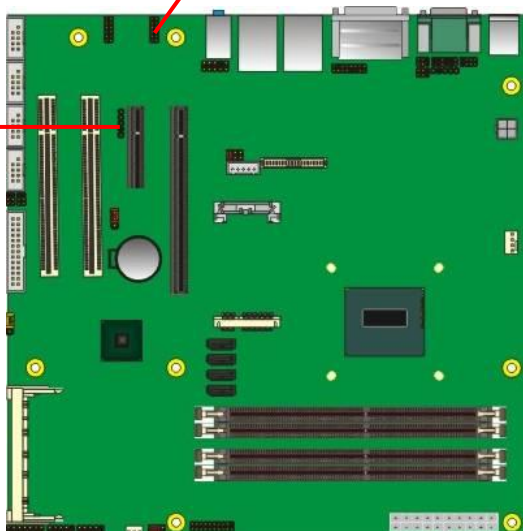

2.14 <Power Supply and Fan Interface >

The **ME-C79** needs a standard ATX power supply from with 24-pin ATX connector and additional 12V connector, the 4-pin additional power connector is optional for PCI Express powering. The board provides one 4-pin fan connector supports smart fan for CPU cooler and one 3-pin cooler fan connectors for system and Northbridge chip. Please connect this well before you finishing the system setup.

2.14.1 <Power Input>

Connector: **CN_12V**

Type: 4-pin DC power connector

Pin	Description	Pin	Description
1	Ground	2	Ground
3	+12V	4	+12V

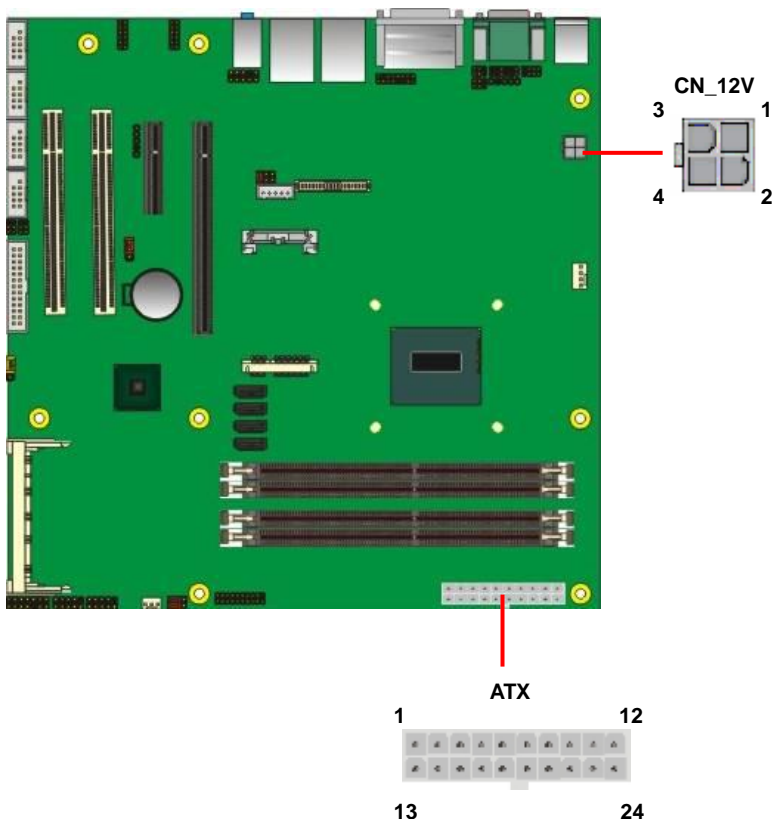

2.14.2 <Fan connector>

The board provides one **4-pin** fan connectors supporting smart fan for CPU cooler and one **3-pin** cooler fan connectors for system.

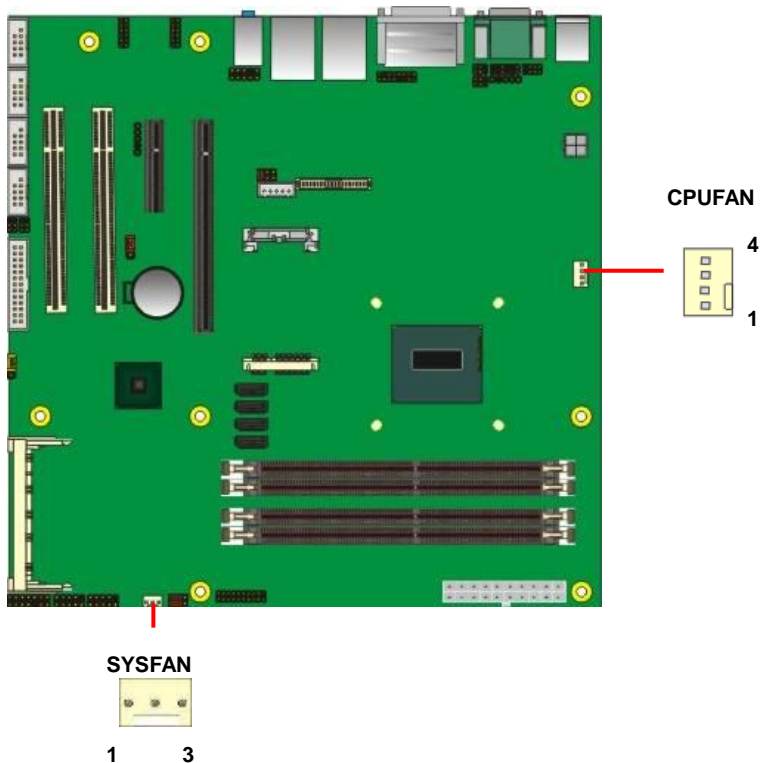

Connector: **CPUFAN**

Type: 4-pin fan wafer connector

Pin	Description	Pin	Description
1	Ground	2	+12V
3	Fan Speed Detection	4	Fan Control

Connector: **SYSFAN**

Type: 3-pin fan wafer connector

Pin	Description	Pin	Description	Pin	Description
1	Ground	2	+12V	3	Sense

2.15 <Switch and Indicator>

The **JFRNT** provides front control panel of the board, such as power button, reset and beeper, etc. Please check well before you connecting the cables on the chassis.

Connector: **JFRNT**

Type: onboard 14-pin (2 x 7) 2.54-pitch header

Function	Signal	PIN		Signal	Function
IDE LED	HDLED+	1	2	PWRLED+	Power LED
	HDLED-	3	4	N/C	
Reset	Reset+	5	6	PWRLED-	Speaker
	Reset-	7	8	SPK+	
N/C		9	10	N/C	
Power Button	PWRBT+	11	12	N/C	
	PWRBT-	13	14	SPK-	

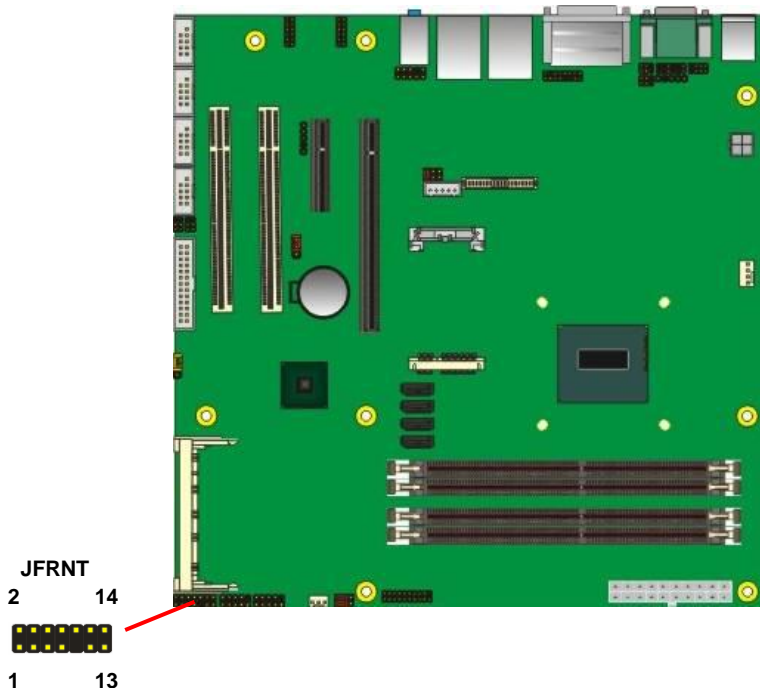

Chapter 3 <System Setup>

3.1 <Audio Configuration>

The board integrates Intel® QM87 with REALTEK® ALC888 codec. It can support 2-channel sound under system configuration. Please follow the steps below to setup your sound system.

1. Install REALTEK HD Audio driver.
2. Launch the control panel and click Sound.

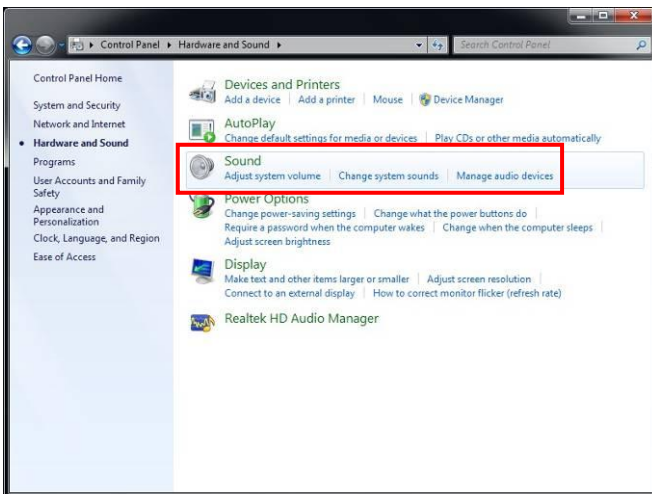

3. Select Speaker Configuration.

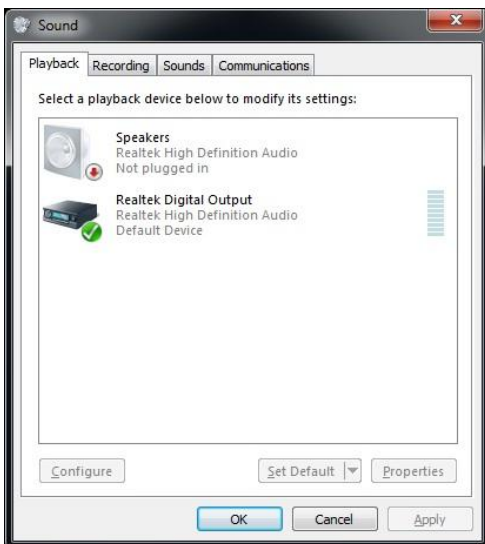

3.2 <Display Properties Setting>

Based on Intel QM87 with HD Graphic, the board supports two DACs for display device as different resolution and color bit.

Please install the Intel Graphic Driver before you starting setup display devices.

1. Click right button on desktop to launch **“Screen resolution”** and click **Advanced settings**, or click the **“Graphics Properties...”** directly into the **Intel(R) HD Graphics Control Panel**.

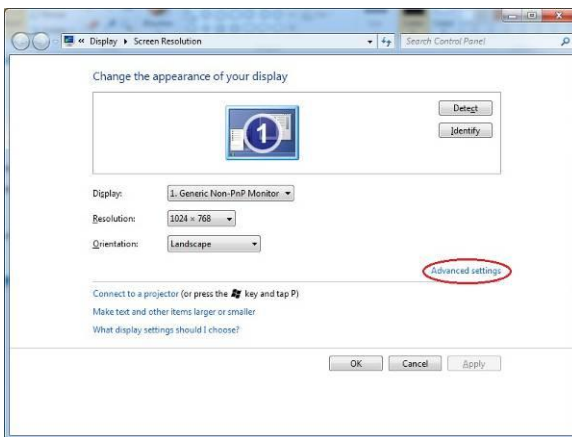
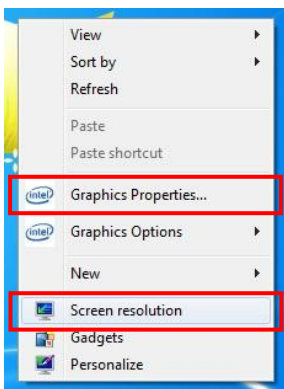

2. Click **Intel(R) HD Graphics Control Panel** button for more setup.

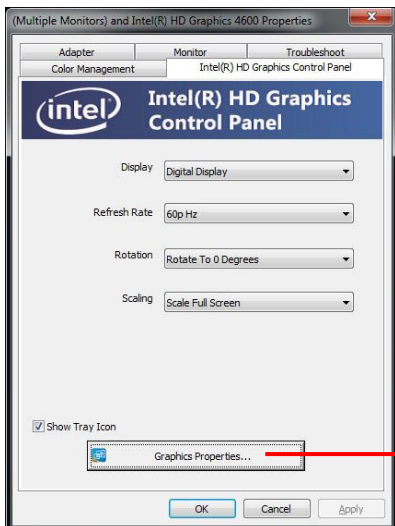

Click Graphics Properties... for advanced setup

3. This setup options can let you define each device settings.

Click **Display Settings** to setup the monitor for Resolution and Refresh Rate

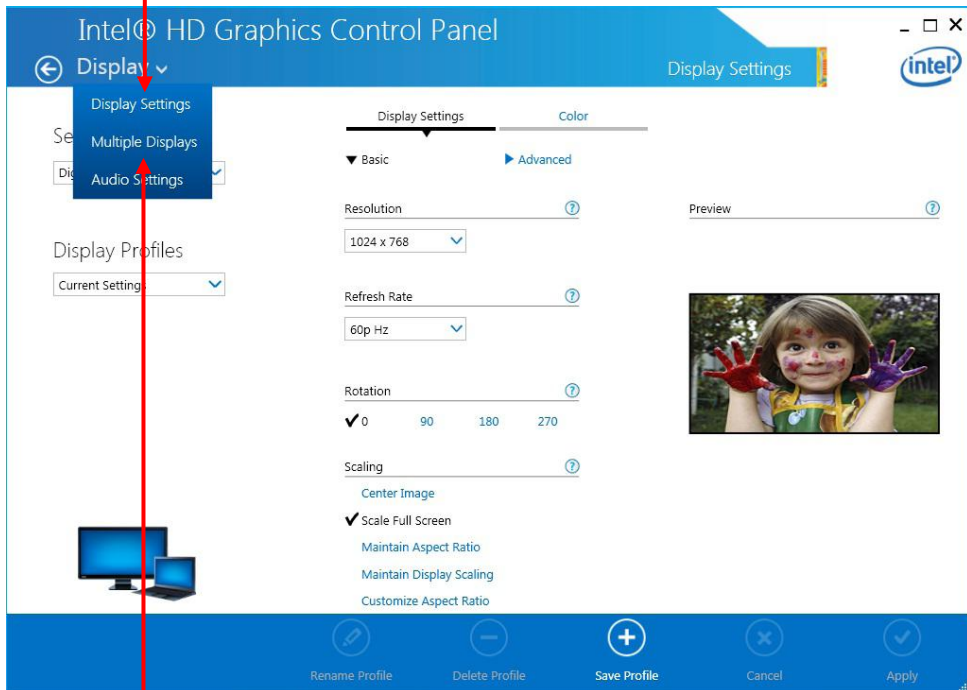

Click **Multiple Displays** to setup the triple display mode as same screen

3.3 <SATA configuration>

SATA Mode:

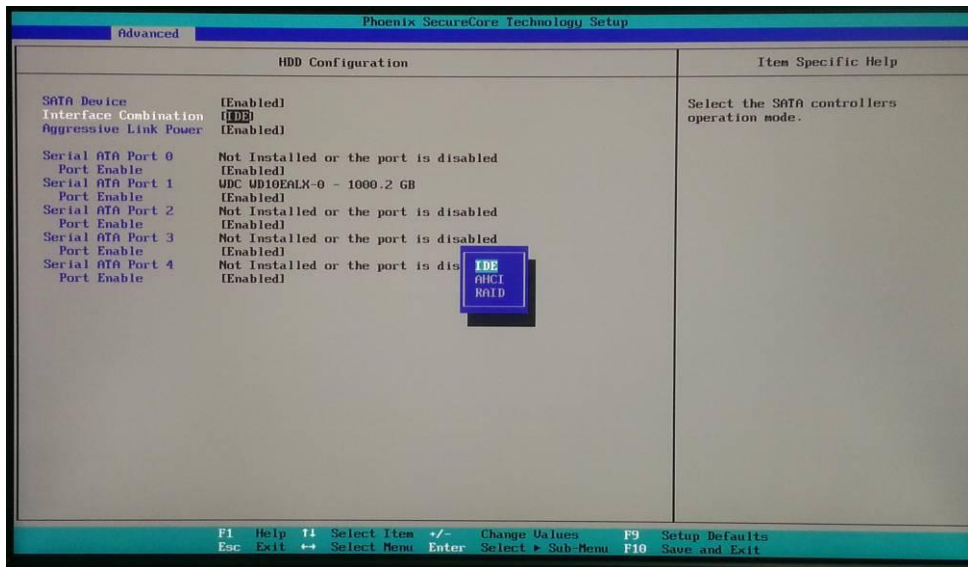

This option can let you select whether the Serial ATA hard drives would work under normal IDE mode, AHCI mode or RAID mode. The RAID mode requires more than one HDD before use.

3.4 <SATA RAID Configuration>

The board integrates Intel® QM87 PCH with RAID function for Serial ATA drives, and supports the configurations below:

RAID 0 (Striping): Two hard drives operating as one drive for optimized data R/W performance. It needs two unused drives to build this operation.

RAID 1 (Mirroring): Copies the data from first drive to second drive for data security, and if one drive fails, the system would access the applications to the workable drive. It needs two unused drives or one used and one unused drive to build this operation. The second drive must be the same or larger size than first one.

RAID 5 (striping with parity)

A RAID 5 array contains three or more hard drives where the data is divided into manageable blocks called strips. Parity is a mathematical method for recreating data that was lost from a single drive, which increases fault-tolerance. The data and parity are striped across all the hard drives in the array. The parity is striped in a rotating sequence to reduce bottlenecks associated with the parity calculations.

RAID 10 (RAID 0+1)

A RAID 10 array uses four hard drives to create a combination of RAID levels 0 and 1. The data is striped across a two-drive array forming the RAID 0 component. Each of the drives in the RAID 0 array is then mirrored by a RAID 1 component.

Intel Rapid Storage Technology: This technology would allow you to use **RAID 0+1** mode on only two drives (4 drives needed on traditional RAID 0+1). It will create two partitions on each hard drive to simulate **RAID 0** and **RAID 1**. It also can let you modify the partition size without re-formatted.

For more information of Intel Rapid Storage Technology, please visit Intel's website.

If you need to install an operation system on the RAID set, please use the driver disk attached in the package when it informs you to obtain the RAID drivers.

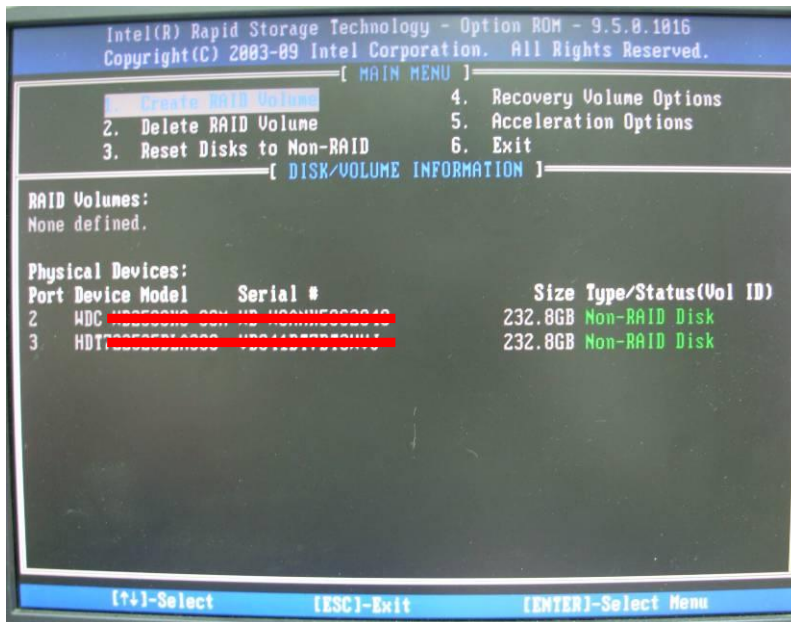

When you boot, press <CTRL+I> to enter the RAID configuration menu.

If you are installing Windows 7, when the installation is complete, please install the Intel® Rapid Storage Technology.

If you are installing Windows XP, first, you need to install the RAID driver in the installation screen (need a floppy disk).

Chapter 4 <BIOS Setup>

The motherboard uses the Phoenix BIOS for the system configuration. The Phoenix BIOS in the single board computer is a customized version of the industrial standard BIOS for IBM PC AT-compatible computers. It supports Intel x86 and compatible CPU architecture based processors and computers. The BIOS provides critical low-level support for the system central processing, memory and I/O sub-systems.

The BIOS setup program of the single board computer let the customers modify the basic configuration setting. The settings are stored in a dedicated battery-backed memory, NVRAM, retains the information when the power is turned off. If the battery runs out of the power, then the settings of BIOS will come back to the default setting.

The BIOS section of the manual is subject to change without notice and is provided here for reference purpose only. The settings and configurations of the BIOS are current at the time of print, and therefore they may not be exactly the same as that displayed on your screen.

To activate CMOS Setup program, press key immediately after you turn on the system. The following message "Press DEL to enter SETUP" should appear in the lower left hand corner of your screen. When you enter the CMOS Setup Utility, the Main Menu will be displayed as **Figure 4-1**. You can use arrow keys to select your function, press <Enter> key to accept the selection and enter the sub-menu.

Figure 4-1 CMOS Setup Utility Main Screen

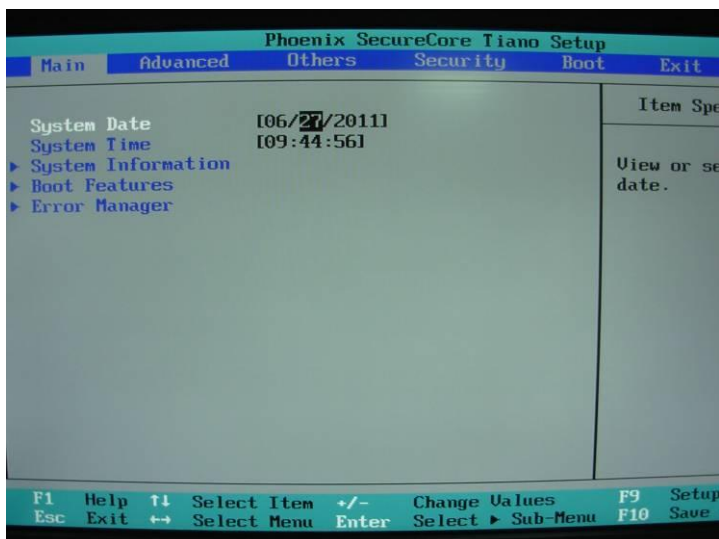

(This page is left for blank)

Appendix A <I/O Port Pin Assignment>

A.1 <Serial ATA Port>

Connector: **SATA3**

Type: 7-pin wafer connector

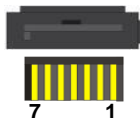

1	2	3	4	5	6	7
GND	RSATA_TXP1	RSATA_TXN1	GND	RSATA_RXN1	RSATA_RXP1	GND

A.2 <IrDA Port>

Connector: **CN_IR**

Type: 5-pin header for SIR Ports

JCSEL1 must jump to "SIR"

Pin	Description
1	VCC
2	N/C
3	IRRX
4	Ground
5	IRTX



A.3 <LAN Port>

Connector: **RJ45**

Type: RJ45 connector with LED on bracket

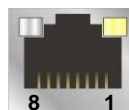

Pin	1	2	3	4	5	6	7	8
Description	MI0+	MI0-	MI1+	MI2+	MI2-	MI1-	MI3+	MI3-

A.4 <LPC Port>

Connector: **CN_LPC**

Type: 10-pin header for LPC Port



Pin	Description	Pin	Description
1	LPC_CLK	2	RESET-
3	-LFRAME	4	LAD3
5	LAD2	6	LAD1
7	LAD0	8	+3.3V
9	SERIRQ	10	Ground
11	3.3V	12	N/C

Appendix B <Flash BIOS>

B.1 <Flash Tool>

The board is based on Phoenix BIOS and can be updated easily by the BIOS auto flash tool. You can download the tool online at the address below:

<http://www.phoenix.com/en/home/>
http://www.commell.com.tw/Support/Support_SBC.htm

File name of the tool is "Fpt.exe", it's the utility that can write the data into the BIOS flash chip and update the BIOS.

B.2 <Flash BIOS Procedure>

1. Please make a bootable floppy disk.
2. Get the last .bin files you want to update and copy it into the disk.
3. Copy Phlash16.exe to the disk.
4. Power on the system and flash the BIOS.
(Example: C:/fpt -savemac -f XXX.bin)
5. Restart the system.

Any question about the BIOS re-flash please contact your distributors or visit the web-site at below:

<http://www.commell.com.tw/support/support.htm>

Appendix C <Programming GPIO's>

The GPIO can be programmed with the MSDOS debug program using simple IN/OUT commands. The following lines show an example how to do this.

```
GPIO0.....GPIO7  bit0.....bit7
-o 2 E 87          ;enter configuration
-o 2 E 87
-o 2 E 07
-o 2 F 09          ;enable GPIO function
-o 2 E 30
-o 2 F 02          ;enable GPIO configuration
-o 2 E F0
-o 2 F xx          ;set GPIO as input/output; set '1' for input,'0'for
output
-o 2 E F1
-o 2 F xx          ;if set GPIO's as output,in this register its value can
be set
```

Optional :

```
-o 2 E F2
-o 2 F xx          ; Data inversion register ; '1' inverts the current valus
of the bits , '0' leaves them as they are
-o 2 E 30
-o 2 F 01          ; active GPIO's
```

For further information, please refer to Winbond W83627DHG datasheet.

Appendix D <Programming Watchdog Timer >

The watchdog timer makes the system auto-reset while it stops to work for a period.

The integrated watchdog timer can be setup as system reset mode by program.

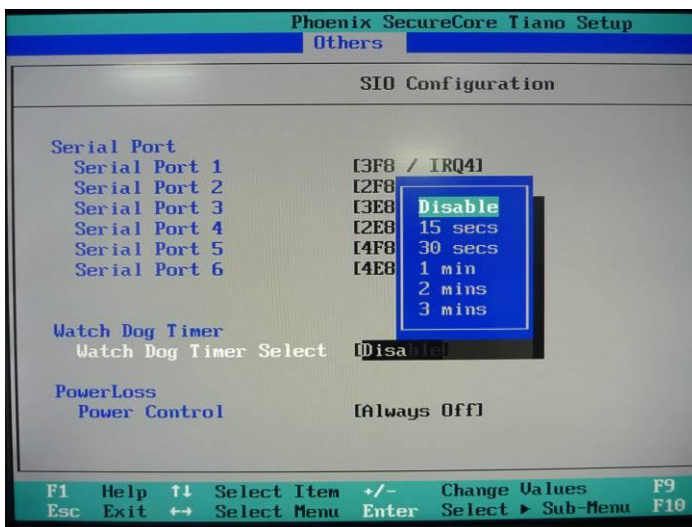

Timeout Value Range

- 1 to 255
- Second or Minute

Program Sample

Watchdog timer setup as system reset with 5 second of timeout

```

2E, 87
2E, 87
2E, 07
2F, 08      Logical Device 8
2E, 30      Activate
2F, 01
2E, F5      Set as Second*
2F, 00
2E, F6      Set as 5
2F, 05
    
```

* Minute: bit 3 = 1; Second: bit 3 = 0

You can select Timer setting in the BIOS, after setting the time options, the system will reset according to the period of your selection.

Contact Information

Any advice or comment about our products and service, or anything we can help you please don't hesitate to contact with us. We will do our best to support you for your products, projects and business.

Taiwan Commate Computer Inc.

Address	19F., No.94, Sec. 1, Xintai 5th Rd., Xizhi Dist., New Taipei City 22102, Taiwan
TEL	+886-2-26963909
FAX	+886-2-26963911
Website	http://www.commell.com.tw
E-Mail	info@commell.com.tw (General Information) tech@commell.com.tw (Technical Support)

Commell is a brand name of Taiwan commate computer Inc.