VXC/VEX Cards User's Manual

VXC-112(A)U/112iAU, VXC-142(A)U/142i(A)U,
VXC-182i(A)U, VXC-114U/114iAU, VXC-144U/144iU
VEX-114/114i, VEX-144/144i

Warranty

All products manufactured by ICP DAS are warranted against defective materials for a period of one year from the date of delivery to the original purchaser.

Warning

ICP DAS assumes no liability for damages consequent to the use of this product. ICP DAS reserves the right to change this manual at any time without notice. The information furnished by ICP DAS is believed to be accurate and reliable. However, ICP DAS assumes no responsibility for its use, or for any infringements of patents or other rights of third parties resulting from its use.

Copyright

Copyright 2007 by ICP DAS. All rights are reserved.

Trademark

The names used for identification only may be registered trademarks of their respective companies.

Tables of Contents

1.	INTRODUCTION	3
1.1	FEATURES.....	6
1.2	SPECIFICATIONS	6
1.3	PRODUCT CHECK LIST.....	8
1.4	ORDERING INFORMATION	8
1.5	OPTIONS	9
2.	HARDWARE CONFIGURATION.....	11
2.1	BOARD LAYOUT.....	11
2.2	COM PORT MAPPING AND BOARD ID.....	13
2.3	PIN ASSIGNMENT.....	15
2.4	HARDWARE INSTALLATION	19
3.	SOFTWARE INSTALLATION	20
3.1	WINDOWS NT 4.0.....	21
3.2	WINDOWS 2000	24
3.3	WINDOWS XP/2003.....	28
3.4	WINDOWS VISTA.....	36
3.5	WINDOWS 7	41
3.6	LINUX.....	46
4.	PROGRAMMING REFERENCE.....	49
4.1	PCI HARDWARE IDS	49
4.2	I/O ADDRESS MAPPING	50
4.3	UART REGISTER.....	52
4.4	PROGRAMMABLE BAUD RATE	53
4.5.	CUSTOMIZED BAUD RATE	55

1. Introduction

The VXC/VEX multi-port serial card enables user to increase additional communication ports on the PC. It's the on-top-of-the-list choice while you are managing to connect lots of outer devices through your PC; every VXC/VEX card ensures you fluent communication in both time-critical applications and industrial fields. With simply a VXC/VEX card, it has never been that easy for integration of a PC with many other devices, like PLCs, FAB machines, meters, controller devices, laboratory instruments, modems, card readers, serial printers, RFID readers, bar code readers, sensors, etc.

COM-Selector:

Each VXC/VEX card is equipped with a COM-Selector (Dip Switch) for the COM port number selection (automatically or manually). It's an important and innovative feature for the VXC/VEX family.

The COM-Selector provides the following advantages:

- Simplifies the COM port number selection instead of using configuration utility programs.
- Users can specify the COM port number of the VXC/VEX card as exactly what they want, no matter which PCI slot it is located at.
- Automatically select an available COM port number is supported by setting the COM-Selector (dip switch) to 0 (default).
- No need to install configuration utility and to study its operation for different OS.
- Prevents confusion. Other PnP COM port devices easily confuse users because of adopting the dynamic COM port number setting.
- Easy replacement of an existing card by setting the dip-switch to be the same COM port number.
- Great for mass system installation, since setting the dip-switch to be the same COM port number is very easy.



ESD Protection

The VXC/VEX cards offer TVS diode ESD protection technology, protecting your system from being damaged by the high potential voltages.

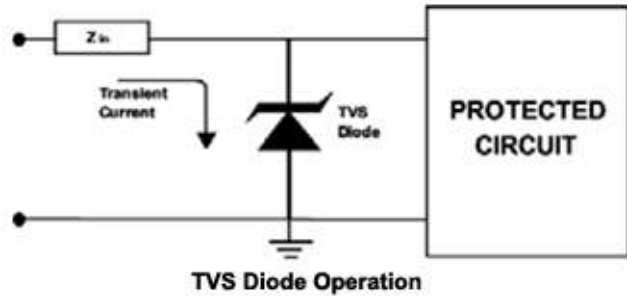

Under normal operating conditions, the TVS diode presents high impedance (appears as an open circuit) to the protected component. When the voltage is beyond the limits, the TVS diode avalanches providing a low impedance path for the transient current. As a result, the transient current is diverted away from the protected components and shunted through the TVS diode. The device returns to a high impedance state after the transient threat passes.

Up To 128 Bytes Hardware FIFO:

The VXC/VEX cards offer TVS diode ESD protection technology, protecting your system from being damaged by the high potential voltages.

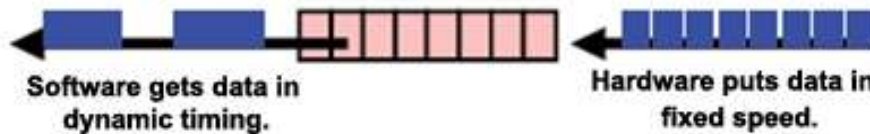

VXC/VEX Cards are equipped with 16 or 128 bytes hardware FIFO for each port. Large hardware FIFO is useful to prevent data lost when your system works on heavy loading, and even helpful while you are running on a multi-task operating system, such as Windows, Linux...etc.

Up To 128 KB COM Port Buffer:

The VXC/VEX card driver for Windows features a 128 KB maximum software FIFO for each port (default is 4 KB). It's practical for large file transmission.

Self-Tuner:

The VXC/VEX card is equipped with a “Self-Tuner” chip to control the sending/receiving direction of RS-485 ports automatically.

Without the help of Self-Tuner, users need to enable RS-485 transmitter before sending, and disable the transmitter after finishing sending. The timing to enable and disable transmitter (direction control) is the major issue on many communication problems, and it is very difficult to debug.

The built-in Self-Tuner on VXC/VEX cards effectively gets rid of this direction control issue and also simplifies software programming for communication applications.

Isolation:

Some VXC/VEX cards offer photo isolation to protect your computer and equipment against damages in harsh environment.

Photo coupler is a device that uses a short optical transmission path to transfer a signal between elements of a circuit, typically a transmitter and a receiver. This keeping them electrically isolated — since the signal goes from an electrical signal to an optical signal, the electrical contact along the path is broken.

It can help cutting down on ground loops, common mode voltages and block voltage spikes, provide electrical isolation, and offer significant protection from serious over-voltage conditions in one circuit affecting the other.

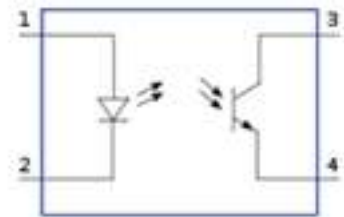

Photo Coupler Operation

Short Card Design:

The “Short Card” design is suitable for compact-sized computer, especially for IPC (Industrial Personal Computer) and servers.

Universal PCI (3.3 V and 5 V):

The Universal PCI card works with both new 3.3 V PCI bus that has been widely-used in servers, and traditional 5 V PCI bus. The universal PCI interface will be the standard for every card from ICP DAS in the near future.

1.1 Features

- Universal PCI V2.2, supports 5 V and 3.3 V PCI bus / PCI Express bus
- COM-Selector
- Provides surge protection
- 128 Byte UART FIFO

1.2 Specifications

	VXC-112(A)U	VXC-112iAU	VXC-182i(A)U	VXC-142(A)U	VXC-142i(A)U	VXC-144U	VXC-144iU	VXC-114U	VXC-114iAU
Bus	Universal PCI (5 V and 3.3 V)								
Connector	Male DB-9					Female DB-37			
RS-232	2-ports	2-ports	1-ports	-	-	-	-	4-ports	4-ports
RS-422/485	-	-	1-ports	2-ports	2-ports	4-ports	4-ports	-	-
Self-tuner or equivalence design	-	-	Yes (COM1)	Yes	Yes	Yes	Yes	-	-
Isolation	-	2.5 kV	2.5 kV	-	2.5 kV	-	2.5 kV	-	2.5 kV
COM-Selector	Yes								
UART	16C950 Compatible								
Baud rate	50 ~ 115200 bps								
Data bits	5, 6, 7, 8								
Parity Bit	None, Even, Odd, Mark, Space								
Stop Bits	1, 1.5, 2								
FIFO size	128 Bytes								
Operating Temperature	0 ~ 50 °C								
Storage Temperature	-20 ~ 70 °C								
Humidity	0 ~ 90 % non-condensing								
Dimensions (mm)	130 X105	130 X105	130 X105	130 X105	130 X105	129 X83	129 X83	129 X83	129 X83

	VEX-144	VEX-144i	VEX-114	VEX-114i
Bus	PCI Express			
Connector	Female DB-37			
RS-232	-	-	4-ports	4-ports
RS-422/485	4-ports	4-ports	-	-
Self-tuner or equivalence design	Yes	Yes	-	-
Isolation	-	2.5 kV	-	2.5 kV
COM-Selector	Yes			
UART	16C950 Compatible			
Baud rate	50 ~ 115200 bps			
Data bits	5, 6, 7, 8			
Parity Bit	None, Even, Odd, Mark, Space			
Stop Bits	1, 1.5, 2			
FIFO size	128 Bytes			
Operating Temperature	0 ~ 50 °C			
Storage Temperature	-20 ~ 70 °C			
Humidity	0 ~ 90 % non-condensing			
Dimensions (mm)	114X101	114X101	110X110	110X110

1.3 Product Check List

The package includes the following items:

- One VXC/VEX series card
- One ICP DAS software CD
- One Quick Start

It is recommended that you read the Quick Start to see the software driver location first.

Attention!







If any of these items are missing or damaged, contact the dealer from whom you purchased the product. Save all shipping materials and the carton in case you need to ship or store the product in the future.

1.4 Ordering Information

Model	Description
VEX-114	PCI Express, 4-port RS-232 communication board
VEX-114i	PCI Express, 4-port Isolated RS-232 communication board
VEX-144	PCI Express, 4-port RS-422/485 communication board
VEX-144i	PCI Express, 4-port Isolated RS-422/485 communication board
VXC-112(A)U	Universal PCI, 2-port RS-232 communication board
VXC-112iAU	Universal PCI, 2-port Isolated RS-232 communication board
VXC-114U	Universal PCI, 4-port RS-232 communication board
VXC-114iAU	Universal PCI, 4-port Isolated RS-232 communication board
VXC-142(A)U	Universal PCI, 2-port RS-422/485 communication board
VXC-142i(A)U	Universal PCI, 2-port Isolated RS-422/485 communication board
VXC-144U	Universal PCI, 4-port RS-422/485 communication board
VXC-144iU	Universal PCI, 4-port Isolated RS-422/485 communication board
VXC-182i(A)U	Universal PCI, 1-port Isolated RS-422/485 and 1-port RS-232 communication board

1.5 Options

Item	Description	VXC-112(A)U /112iAU	VXC-182i(A)U	VXC-142(i)(A)U
CA-PC09F 	9-pin Female D-sub connector with plastic cover	✓	✓	✓
DN-09-2/ DN-09-2F 	I/O Connector Block with DIN-Rail Mounting and two 9-Pin male Header	✓	✓	✓
CA-0910F 	9-pin Female-Female D-sub cable, 1 M	✓	✓	✓
CA-0910N 	9-pin Female-Female D-sub cable, 1 M Null Modem Cable	✓	✓	✓
CA-0915 	9-pin Male-Female D-sub cable, 1.5M	✓	✓	✓
CA-090910 	9-pin Female D-sub & (9-wire) RS-422 Cable, 1 M	-	✓	✓
CA-0903 	9-pin Female D-sub & 5-wire RS-232 cable, 30 cm	✓	✓	-
CA-0910 	9-pin Female D-sub & 3-wire RS-232 cable, 1 M	✓	✓	-

Item	Description	VXC-114(iA)U VEX-114(i)	VXC-144(i)U VEX-144(i)
CA-4002 	37-pin Male D-sub connector with plastic cover	✓	✓
DN-37 	I/O Connector Block (Pitch= 5.08 mm) with DIN-Rail Mounting Include: One CA-3710 (37-pin Male-Male D-sub cable 1.0 M)	✓	✓
CA-3710 	37-Pin Male-Male D-sub cable 1 M (45°)	✓	✓
CA-3710D 	37-Pin Male-Male D-sub cable 1M (180°)	✓	✓
CA-3720 	DB-37 Male-Male D-sub cable 2 M Cable(45 °)	✓	✓
CA-3720D 	37-Pin Male-Male D-sub cable 2 M (180°)	✓	✓
CA-9-3715D 	DB-37 Male(D-sub) to 4-Port DB-9 Male(D-sub) cable 1.5 M (180 °)	✓	✓

2. Hardware configuration

2.1 Board Layout

- Board layout of the VXC-114U/114iAU/144U/144iU

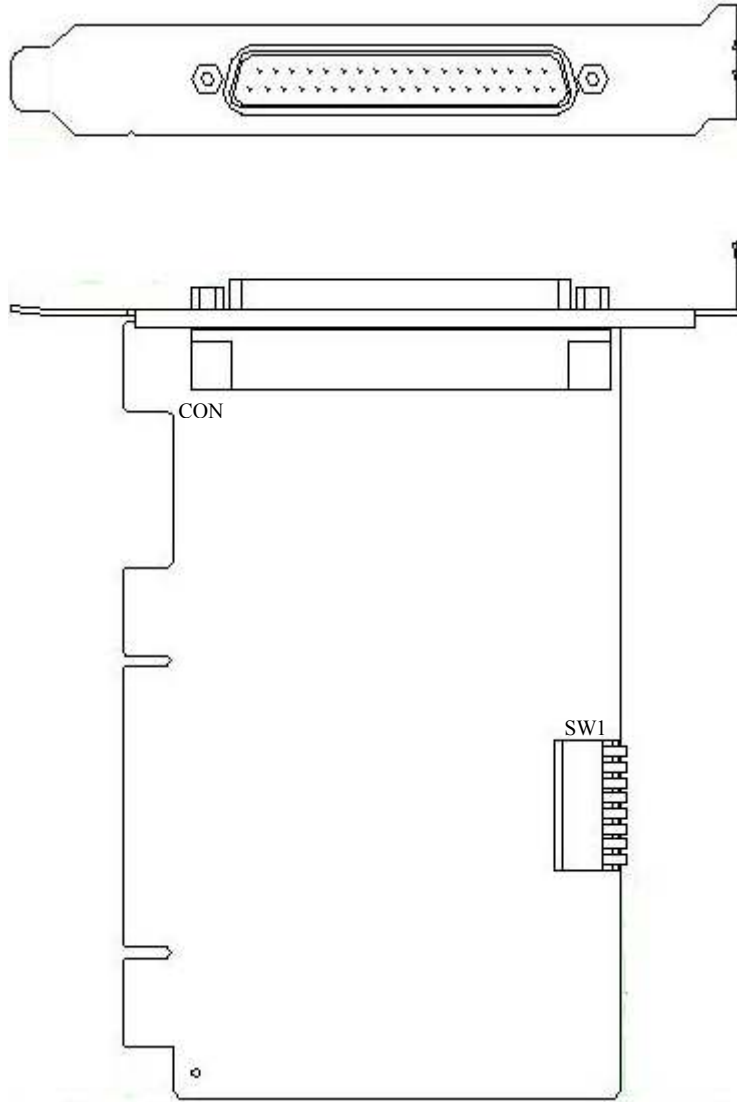

- Board layout of the VXC-112(A)U/112iAU/142(A)U/142i(A)U/182i(A)U

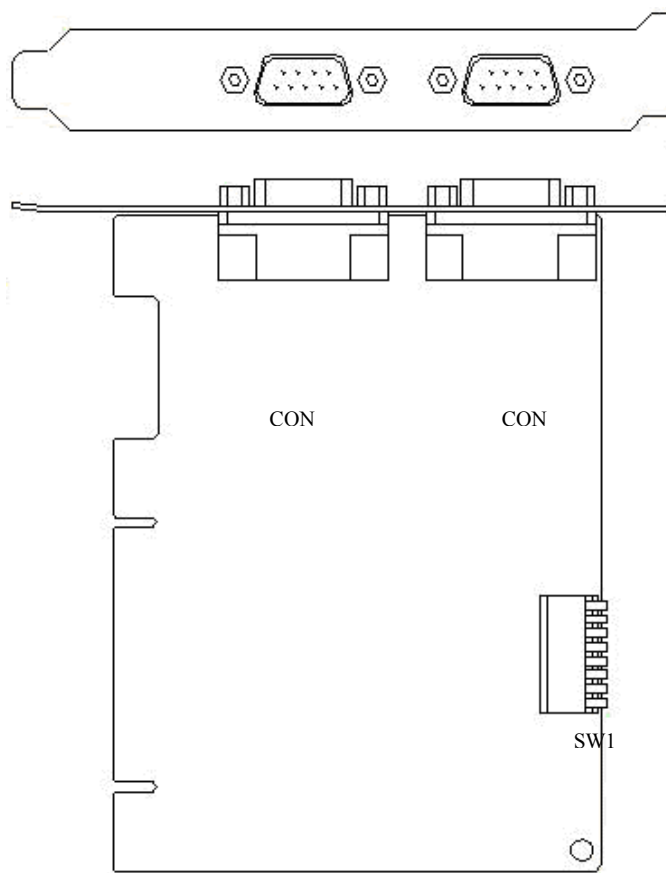

- Board layout of the VEX-114/114i/144/144i

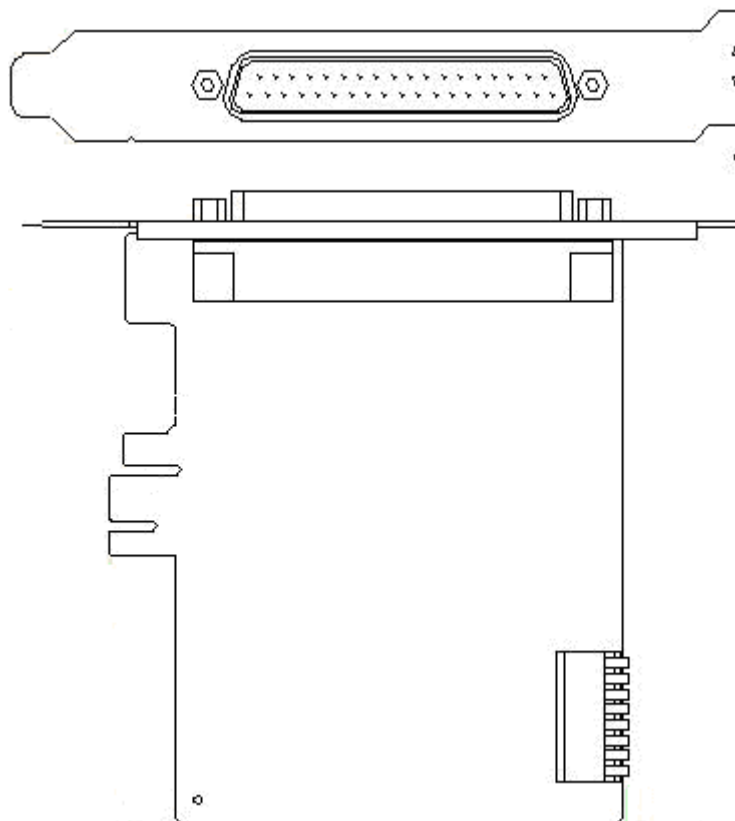

2.2 COM Port Mapping and Board ID

The Board ID and COM port mapping are the same, which is set by the SW1 DIP switch. The SW1 DIP switch has different functions under different OS.

For **DOS** users, the SW1 DIP switch acts as **Board ID**. When there are two or more multi-port serial cards in a single system, it is difficult to identify individual card number. For easier identification, the VXC/VEX series card includes a Board ID function.

For **Windows** users, the SW1 DIP switch acts as **COM port number selector** and the COM port number is depending on the Board ID. If the Board ID is 0, then the driver finds a valid number for each port. If the Board ID is not 0, then the driver uses the “**Board ID**” to be the first COM port number and uses the “**Board ID +1**” to be the next COM port number and so on.

Note:

It's recommended to select a unique COM port number (Board ID) by users. This helps users to clear identify and fix the card-number and port-number in a system.

Warning:

The port will not work if the COM port number is conflicted under Windows or Linux system. In that case, users should try other COM port numbers.

Usually, the COM1 and COM2 are reserved by systems. And it's recommended to reserve the COM3 and COM4 if you will have other Plug&Play serial ports in the future. This prevents conflict.

For **Linux** users, it's the same as Windows users but for **TTY device number selector**.

The configuration examples are as follows.

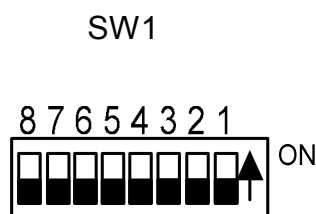

SW1 DIP Switch	8	7	6	5	4	3	2	1
Board ID= 0x00 (Default) COM = Auto-defined	OFF	OFF	OFF	OFF	OFF	OFF	OFF	OFF
Board ID= 0x03 COM = 3/4/5/6	OFF	OFF	OFF	OFF	OFF	OFF	ON	ON
Board ID= 0x05 COM = 5/6/7/8	OFF	OFF	OFF	OFF	OFF	ON	OFF	ON
Board ID= 0x07 COM = 7/8/9/10	OFF	OFF	OFF	OFF	OFF	ON	ON	ON
Board ID= 0x09 COM = 9/10/11/12	OFF	OFF	OFF	OFF	ON	OFF	OFF	ON
Board ID= 0x14 COM = 20/21/22/23	OFF	OFF	OFF	ON	OFF	ON	OFF	OFF
Board ID= 0x1E COM = 30/31/32/33	OFF	OFF	OFF	ON	ON	ON	ON	OFF
Board ID= 0x28 COM = 40/41/42/43	OFF	OFF	ON	OFF	ON	OFF	OFF	OFF
Board ID= 0x32 COM = 50/51/52/53	OFF	OFF	ON	ON	OFF	OFF	ON	OFF
Board ID= 0x3C COM = 60/61/62/63	OFF	OFF	ON	ON	ON	ON	OFF	OFF
Board ID= 0x64 COM = 100/101/102/103	OFF	ON	ON	OFF	OFF	ON	OFF	OFF
Board ID= 0x96 COM = 150/151/152/153	ON	OFF	OFF	ON	OFF	ON	ON	OFF
Board ID= 0xC8 COM = 200/201/202/203	ON	ON	OFF	OFF	ON	OFF	OFF	OFF
.								
.								
.								
Board ID= 0xFF COM = 255/256/x/x	ON	ON	ON	ON	ON	ON	ON	ON

Note: If multi-port serial board is 2-port VXC card the COM number is the first two numbers.

2.3 Pin Assignment

2.3.1 VXC-112(A)U/VXC-112iAU Pin Assignment

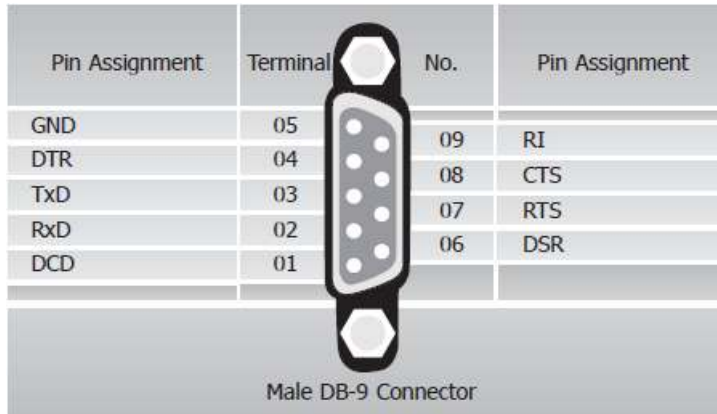

RS-232 Cable Wiring (Null Modem)

System1	Pin		Pin	System2
RxD	2	←	3	TxD
TxD	3	→	2	RxD
GND	5	↔	5	GND
DTR	4	→	6	DSR
	--		1	DCD
DCD	1	↔	--	
DSR	6	←	4	DTR
RTS	7	→	8	CTS
CTS	8	←	7	RTS
RI	9	←	9	RI

2.3.2. VXC-142(i)(A)U Pin Assignment

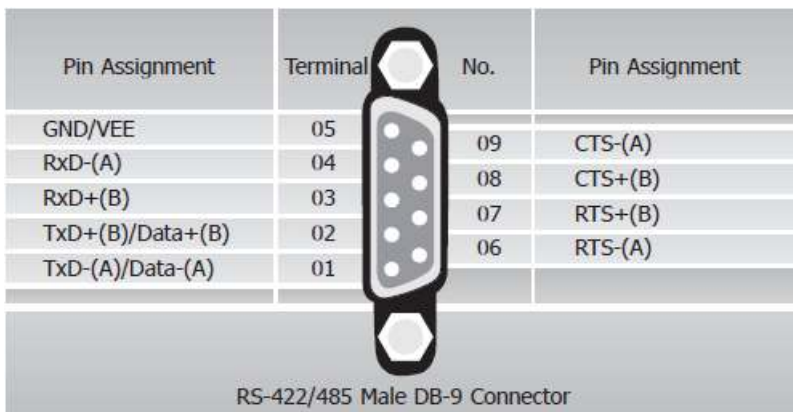

RS-422 Cable Wiring

VXC.COM	Pin No.		Pin No.	VXC.COM
TxD-	1	→	4	RxD-
TxD+	2	→	3	RxD+
RxD+	3	←	2	TxD+
RxD-	4	←	1	TxD-
GND	5	↔	5	GND
RTS-	6	→	9	CTS-
RTS+	7	→	8	CTS+
CTS+	8	←	7	RTS+
CTS-	9	←	6	RTS-

RS-485 Cable Wiring

VXC.COM	Pin No.		Pin No.	VXC.COM
DATA-	1	↔	1	DATA-
DATA+	2	↔	2	DATA+

Warning:

The RS-485 bus is a differential (balanced) signal, thus you cannot wire the Data+ with Data- directly for a single port loop-back test. It will not work at all!

2.3.3. VXC-114(iA)U/VEX-114(i) Pin Assignment

Pin Assignment	Terminal No.	Pin Assignment
N.C.	01	20 RI3
DCD3	02	21 DTR3
GND	03	22 DSR3
CTS3	04	23 RTS3
RxD3	05	24 TxD3
RI4	06	25 DCD4
DTR4	07	26 GND
DSR4	08	27 CTS4
RTS4	09	28 RxD4
TxD4	10	29 RI2
DCD2	11	30 DTR2
GND	12	31 DSR2
CTS2	13	32 RTS2
RxD2	14	33 TxD2
RI1	15	34 DCD1
DTR1	16	35 GND
DSR1	17	36 CTS1
RTS1	18	37 RxD1
TxD1	19	



RS-232 Female DB-37 Connector

DB-37 to 4-port DB-9 (CA-9-3715D)

Pin Assignment	Terminal No.	Pin Assignment
GND	05	09 RI
DTR	04	08 CTS
TxD	03	07 RTS
RxD	02	06 DSR
DCD	01	



Male DB-9 Connector

RS-232 Cable Wiring (Null Modem)

System1	Pin		Pin	System2
RxD	2	←	3	TxD
TxD	3	→	2	RxD
GND	5	↔	5	GND
DTR	4	→	6	DSR
	--		1	DCD
DCD	1	↔	--	
DSR	6	←	4	DTR
RTS	7	→	8	CTS
CTS	8	←	7	RTS
RI	9	←	9	RI

2.3.4. VXC-144(i)U/VEX-144(i) Pin Assignment

Pin Assignment	Terminal No.	Pin Assignment
N.C.	01	
TxD3-(A)/Data3-(A)	02	20 CTS3-(A)
GND/VEE3	03	21 RxD3-(A)
CTS3+(B)	04	22 RTS3-(A)
TxD3+(B)/Data3+(B)	05	23 RTS3+(B)
CTS4-(A)	06	24 RxD3+(B)
RxD4-(A)	07	25 TxD4-(A)/Data4-(A)
RTS4-(A)	08	26 GND/VEE4
RTS4+(B)	09	27 CTS4+(B)
RxD4+(B)	10	28 TxD4+(B)/Data+(B)
TxD2-(A)/Data2-(A)	11	29 CTS2-(A)
GND/VEE2	12	30 RxD2-(A)
CTS2+(B)	13	31 RTS2-(A)
TxD2+(B)/Data2+(B)	14	32 RTS2+(B)
CTS1-(A)	15	33 RxD2+(B)
RxD1-(A)	16	34 TxD1-(A)/Data1-(A)
RTS1-(A)	17	35 GND/VEE1
RTS1+(B)	18	36 CTS1+(B)
RxD1+(B)	19	37 TxD1+(B)/Data1+(B)

RS-422/485 Female DB-37 Connector

DB-37 to 4-port DB-9 (CA-9-3715D)

Pin Assignment	Terminal No.	Pin Assignment
GND/VEE	05	09 CTS-(A)
RxD-(A)	04	08 CTS+(B)
RxD+(B)	03	07 RTS+(B)
TxD+(B)/Data+(B)	02	06 RTS-(A)
TxD-(A)/Data-(A)	01	

RS-422/485 Male DB-9 Connector

RS-422 Cable Wiring

VXC.COM	Pin No.		Pin No.	VXC.COM
TxD-	1	→	4	RxD-
TxD+	2	→	3	RxD+
RxD+	3	←	2	TxD+
RxD-	4	←	1	TxD-
GND	5	↔	5	GND
RTS-	6	→	9	CTS-
RTS+	7	→	8	CTS+
CTS+	8	←	7	RTS+
CTS-	9	←	6	RTS-

RS-485 Cable Wiring

VXC.COM	Pin No.		Pin No.	VXC.COM
DATA-	1	↔	1	DATA-
DATA+	2	↔	2	DATA+

Warning:

The RS-485 bus is a differential (balanced) signal, thus **you cannot wire the Data+ with Data- directly for a single port loop-back test.** It will not work at all!

2.3.5. VXC-182i(A)U Pin Assignment

CN1: Isolation RS-422/485 port

Pin Assignment	Terminal No.	Terminal No.	Pin Assignment
GND/VEE	05	09	CTS-(A)
RxD-(A)	04	08	CTS+(B)
RxD+(B)	03	07	RTS+(B)
TxD+(B)/Data+(B)	02	06	RTS-(A)
TxD-(A)/Data-(A)	01		



RS-422/485 Male DB-9 Connector

RS-422 Cable Wiring

VXC.COM	Pin No.		Pin No.	VXC.COM
TxD-	1	→	4	RxD-
TxD+	2	→	3	RxD+
RxD+	3	←	2	TxD+
RxD-	4	←	1	TxD-
GND	5	↔	5	GND
RTS-	6	→	9	CTS-
RTS+	7	→	8	CTS+
CTS+	8	←	7	RTS+
CTS-	9	←	6	RTS-

Warning:

The RS-485 bus is a differential (balanced) signal, thus **you cannot wire the Data+ with Data- directly for a single port loop-back test.** It will not work at all!

RS-485 Cable Wiring

VXC.COM	Pin No.		Pin No.	VXC.COM
DATA-	1	↔	1	DATA-
DATA+	2	↔	2	DATA+

CN2: RS-232 port

Pin Assignment	Terminal No.	Terminal No.	Pin Assignment
GND	05	09	RI
DTR	04	08	CTS
TxD	03	07	RTS
RxD	02	06	DSR
DCD	01		

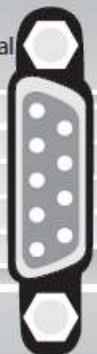

Male DB-9 Connector

RS-232 Cable Wiring (Null Modem)

System1	Pin		Pin	System2
RxD	2	←	3	TxD
TxD	3	→	2	RxD
GND	5	↔	5	GND
DTR	4	→	6	DSR
	--		1	DCD
DCD	1	↔	--	
DSR	6	←	4	DTR
RTS	7	→	8	CTS
CTS	8	←	7	RTS
RI	9	←	9	RI

2.4 Hardware Installation

Warning:

Static electricity can easily damage computer equipment. Ground yourself by touching the chassis of the computer before touching any boards.

To install your VXC/VEX series cards, complete the following steps:

1. Refer to Chapter 3 for installing driver first
2. Shut down and power off your computer
3. Remove all covers from the computer
4. Select an empty PCI slot
5. Remove the PCI slot cover from the PC
6. Carefully insert your VXC/VEX card into the PCI slot
7. Attach the cable to the connector
8. Replace the PC cover
9. Power on the computer

Note:

It's recommended to install driver first, since some OS (operating system such as Windows 2000) may ask you to restart the computer again after driver installation. This reduces the times to restart the computer.

3. Software Installation

ICP DAS provides following device drivers for most operation systems such as Windows NT 4.0 and Windows 2000/XP/2003/2008/Vista32/Windows 7 (32 / 64 bits). These Windows drivers provide full interrupt-driven, buffered I/O for each COM ports. And also supports the Plug & Play mechanism for easy installation.

VxCard_W7_v2.08.00.exe:

This is the VXC/VEX Card driver for Windows NT 4.0, 2000/XP/2003/2008/ Vista32 and Windows 7 (32 / 64 bits).

Note:

Please refer to “**Quick Start**” for getting the location of setup program on CD.

For Windows users to access COM ports, please refer to the “**Serial Communications in Win32**” article for programming information. It can be found by searching on the <http://msdn.microsoft.com>.

This chapter shows you the detail steps to install these drivers.

Note:

For more information about COM port number selection, please refer to **Section 2.2 “COM Port Mapping & Board ID”**.

3.1 Windows NT 4.0

3.1.1 Installation

Note:

It's recommended to install the software first, and then the hardware. This reduces the configuration procedures.

Refer to “**Quick Start**” for getting the location of setup program on CD.

1. Launch the “**VxCard_W7_v2.08.00.exe**” setup program.
2. Click the “**Next >**” button to start installation.
3. Select a folder where setup will install files, and click “**Next>**” button.

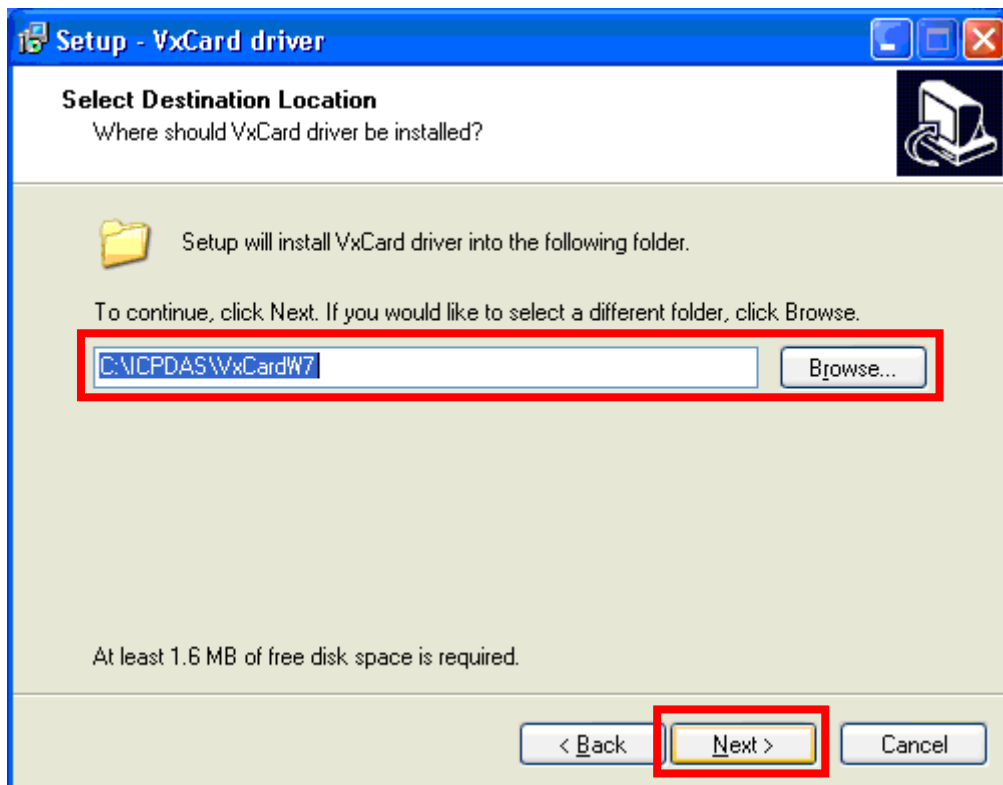

-
4. Select “**No, I will restart the computer later**” and click “**Finish**” button.

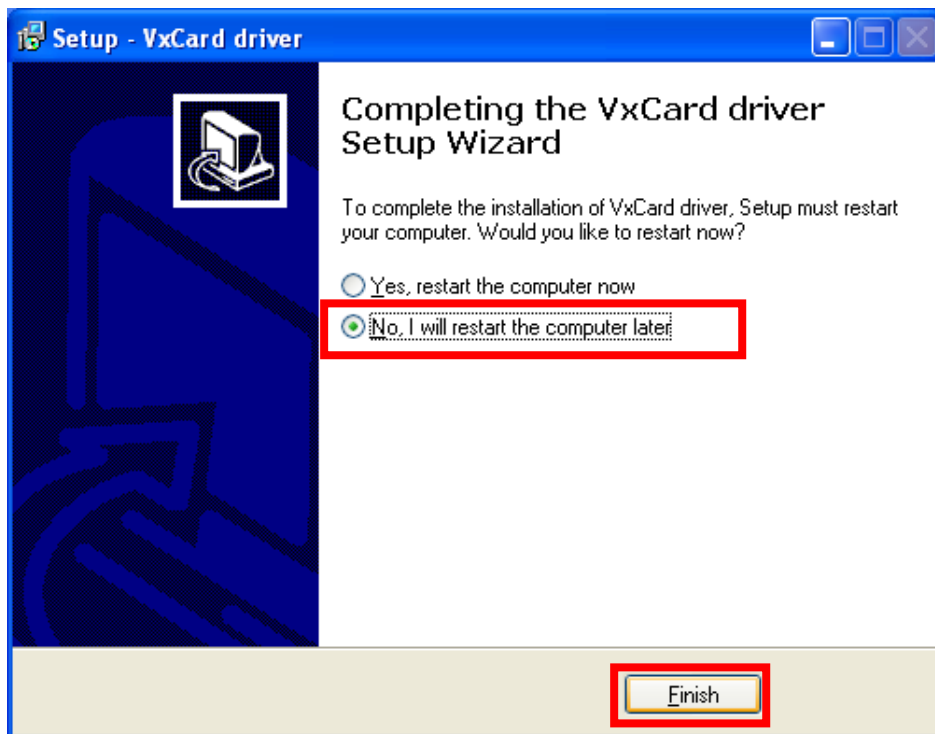

5. Turn off the computer and install the VXC/VEX card into the PC.
6. Power on the computer.

3.1.2 Verification

ICP DAS provides a "VxCard Util" program (VxCard Utility.exe) for users to see all the COM ports on the system. It shows COM ports in two groups, one for VXC/VEX Card and one for others. So, users can check if any conflict occurred between COM ports.

To launch the utility, just double-click on the "VxCard Utility" short-cut on your desktop.

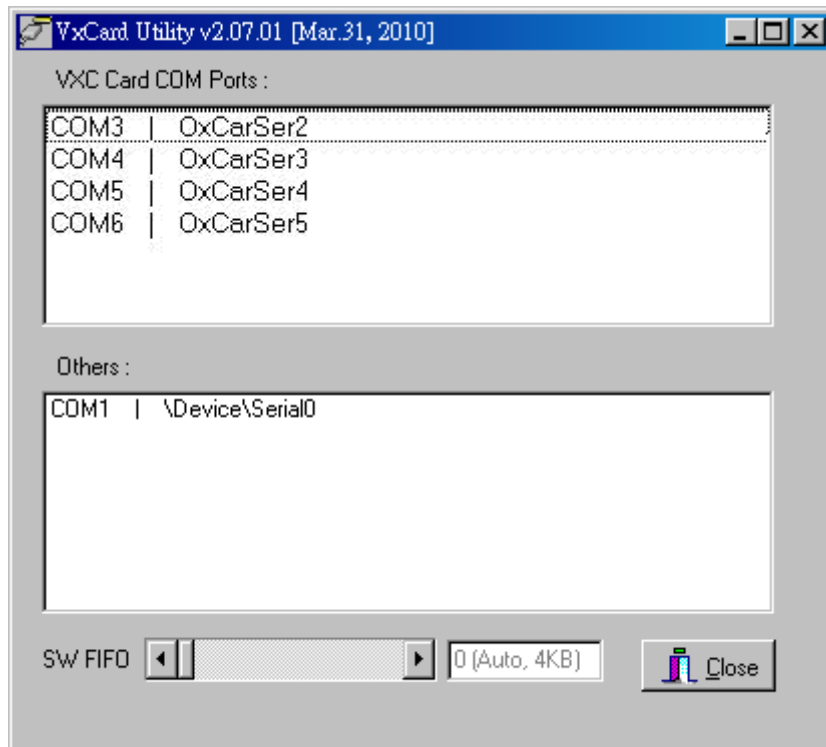

3.1.3 Configuration

If need, users can change the input buffer size (default is 4 KB for each port, up to 128 KB) by setting the "SW FIFO" scroll-bar on the VxCard Utility.

To change the COM port mappings (see **Section 2.2 COM Port Mappings and Board ID**), users should restart the driver by rebooting the computer.

3.2 Windows 2000

3.2.1 Installation

Note:

It's recommended to install the software first, and then the hardware. This reduces the configuration procedures.

Refer to "**Quick Start**" for getting the location of setup program on CD.

1. Launch the **VxCard_W7_v2.08.00.exe** to install the driver and register the related information onto the system.
2. Click "**Next>**" button to start installation.
3. Select a folder where setup will install files, and click "**Next>**" button.

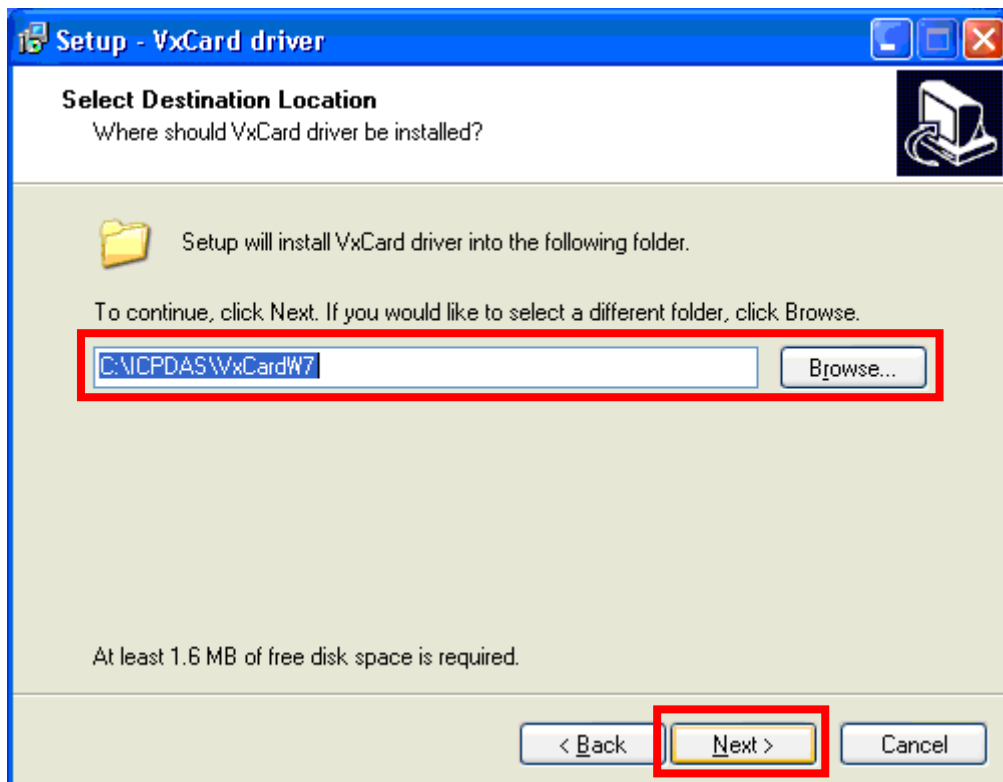

-
4. Select “**No, I will restart the computer later**” and click “**Finish**” button.

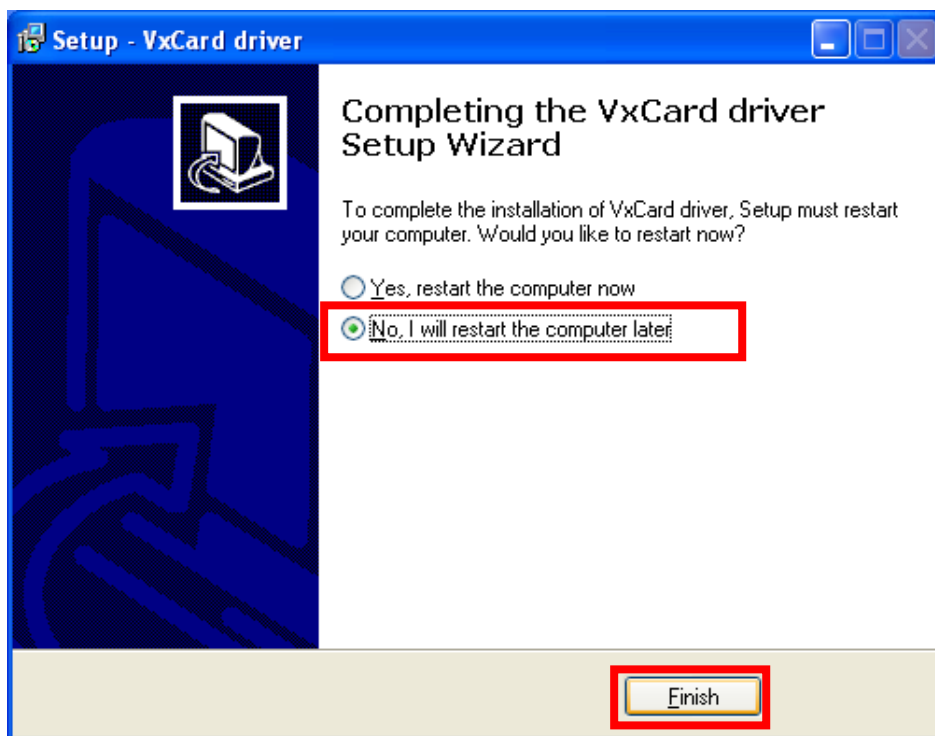

5. Turn off the computer and install the VXC/VEX card into the PC.
6. Power on the computer, Windows 2000 should find the new card and load the driver automatically. (Sometimes Win2K pops up few confirm dialog box, just click “next” or “OK” to finish it.)

3.2.2 Verification

To verify the installation, please complete the following steps:

1. Select **"Start / Settings / Control Panel"** and double-click the **"System"** icon.
2. Click the **"Hardware"** tab and then click the **"Device Manager"** button.

The VXC/VEX Card is listed under the **"VXC Multi-port serial Card"** class, and each Communications Port is listed under the **"Ports (VxCard – RS-232/422/485)"** class.

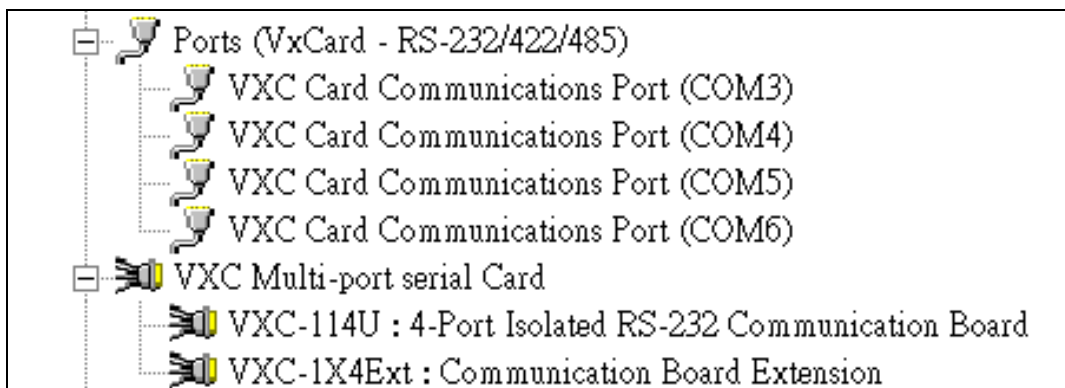

3.2.3 Configuration

If needed, users can change the input buffer size (default is 4 KB for each port, up to 128 KB) by setting the “SW FIFO” scroll-bar on the VxCard Utility. The utility’s short cut is placed on the desktop after installation.

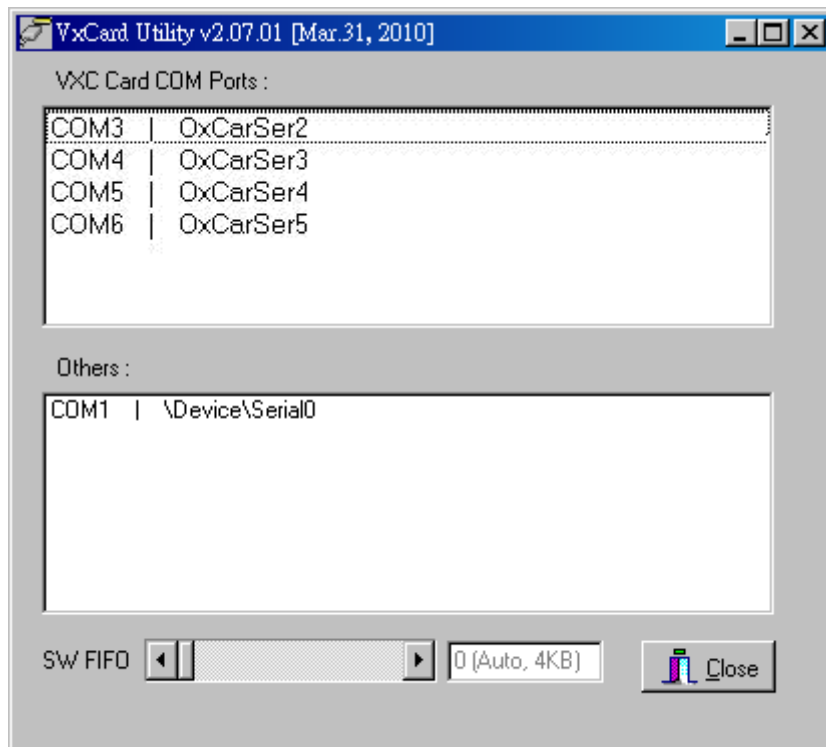

To change the COM port mappings (see **Section 2.2 COM Port Mappings and Board ID**), users should restart the driver by rebooting the computer, or re-install the “**VXC/VEX Card**” hardware in the “**Device Manager**” by un-install card and then scan new hardware.

3.2.4 Uninstallation

Before removing the card from your computer, it’s recommended to uninstall the device from the “**Device Manager**”. This removes unused hardware information from the database (registry) of Windows.

3.3 Windows XP/2003/2008

It's recommend to disable the **Driver Signing** and **Windows Update** options in Windows to suppress the lots of prompt messages during driver installation.

3.3.1 Disable Driver Signing

1. Select "**Start / Settings / Control Panel**" and then "**System**".
2. Select the "**Hardware**" page on "**System Properties**" window and click the "**Driver Signing**" button.

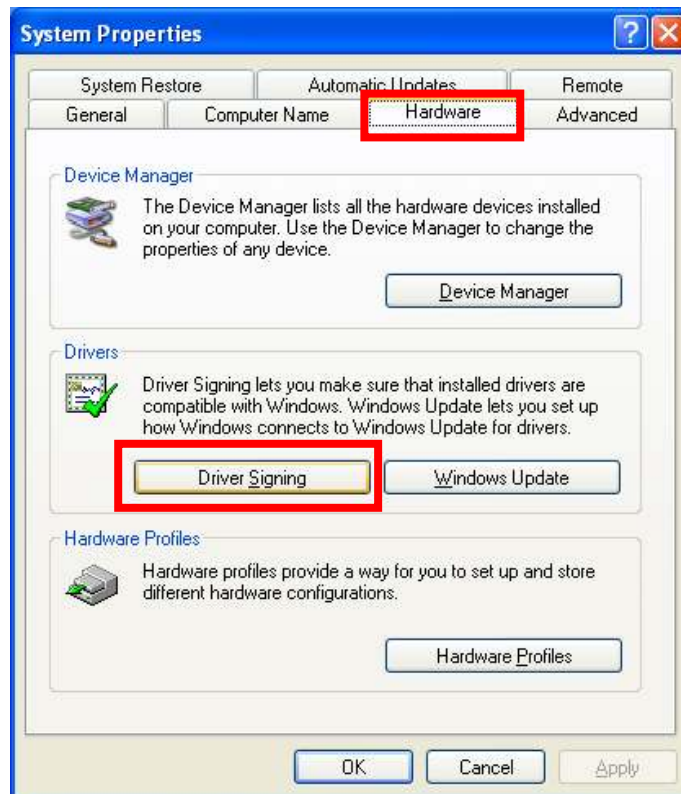

3. Select “**Ignore – Install the software anyway and don’t ask for my approval**”, check “**Make this action the system default**” and then click “**OK**” to close the “**Driver Signing Options**” window.

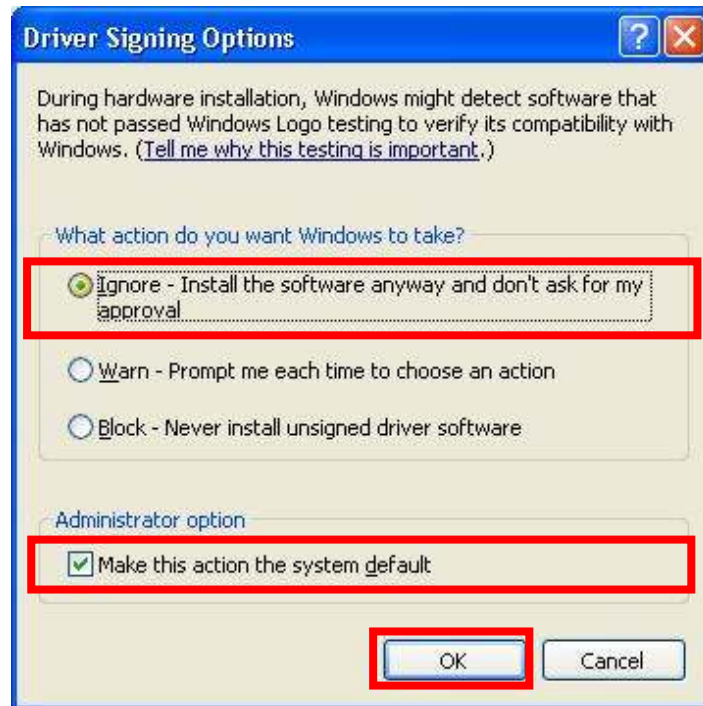

4. Click the “**Windows Update**” button on “**System Properties**” window.

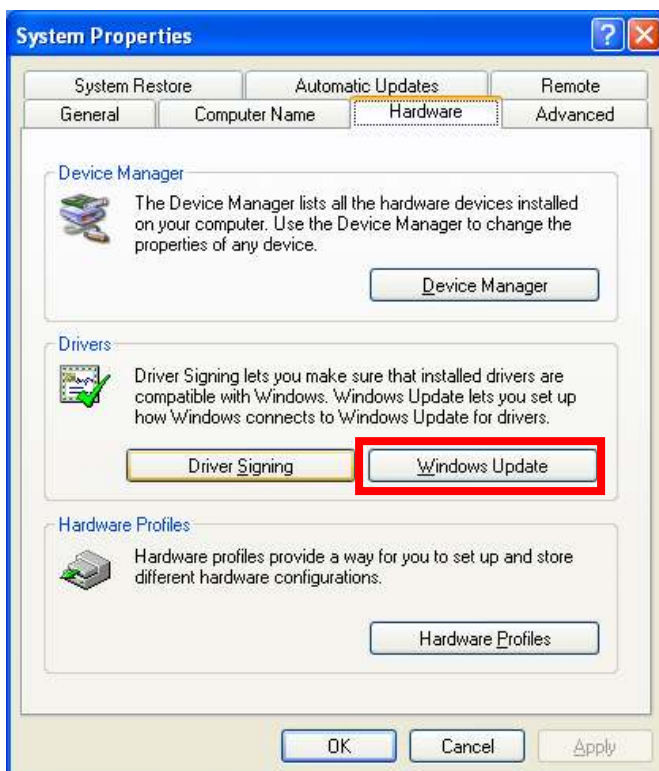

Note:

The “**Windows Update**” setting supports **Windows XP SP2** only. If the system is not Windows XP SP2, please skip step 4 to 6.

-
5. Select “**N**ever search Windows Update for drivers” and click “**O**K”.

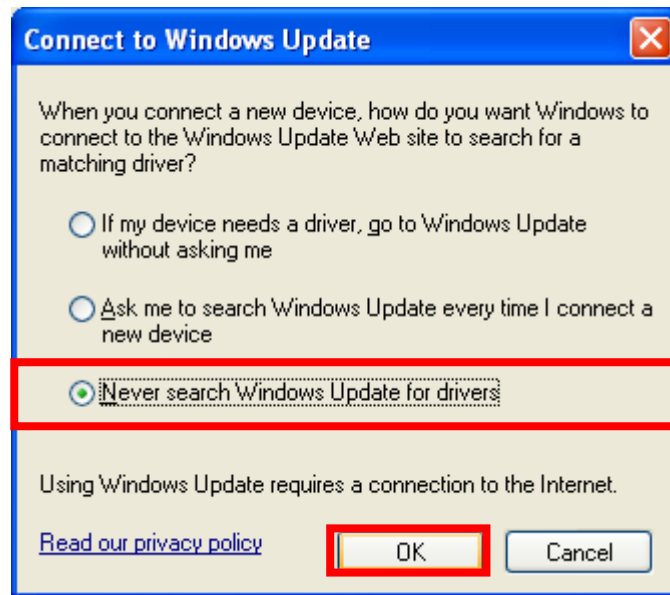

6. Click “**O**K” on “**S**ystem Properties” window to close it.

3.3.2 Driver Installation

Note:

It's recommended to install the software first, and then the hardware. This reduces the configuration procedures.

Refer to “**Q**uick **S**tart” for getting the location of setup program on CD.

1. Launch the **VxCard_W7_v2.08.00.exe** to install the driver and register the related information onto the system.
2. Click “**N**ext>” button to start installation.

3. Select a folder where setup will install files, and click “**Next>**” button.

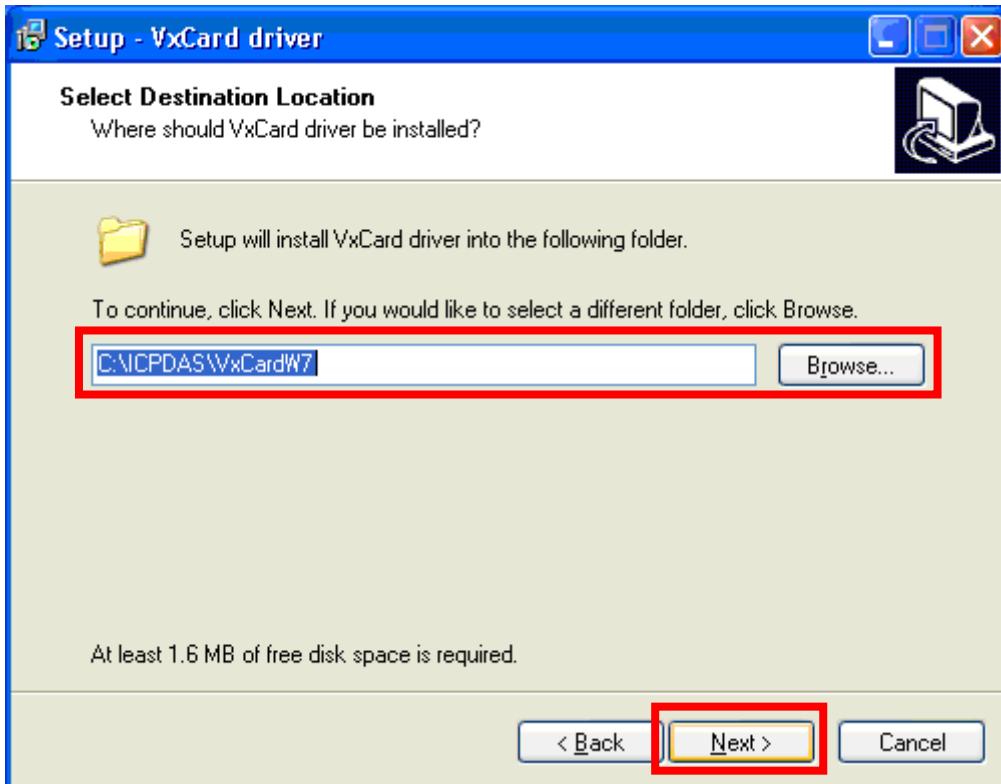

4. Select “**No, I will restart the computer later**” and click “**Finish**” button.

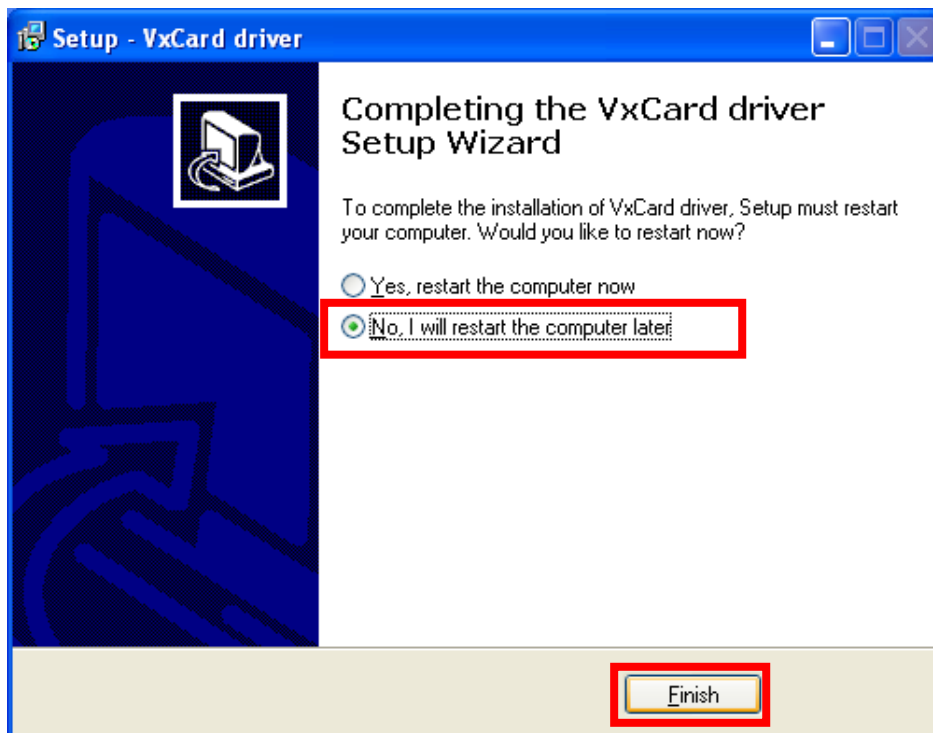

-
5. Turn off the computer and install the VXC/VEX card into the PC.
 6. Power on the computer and continue to finish the Plug and Play procedures.
 7. Select “**Install the software automatically [Recommended]**” and Click “**Next>**” button.

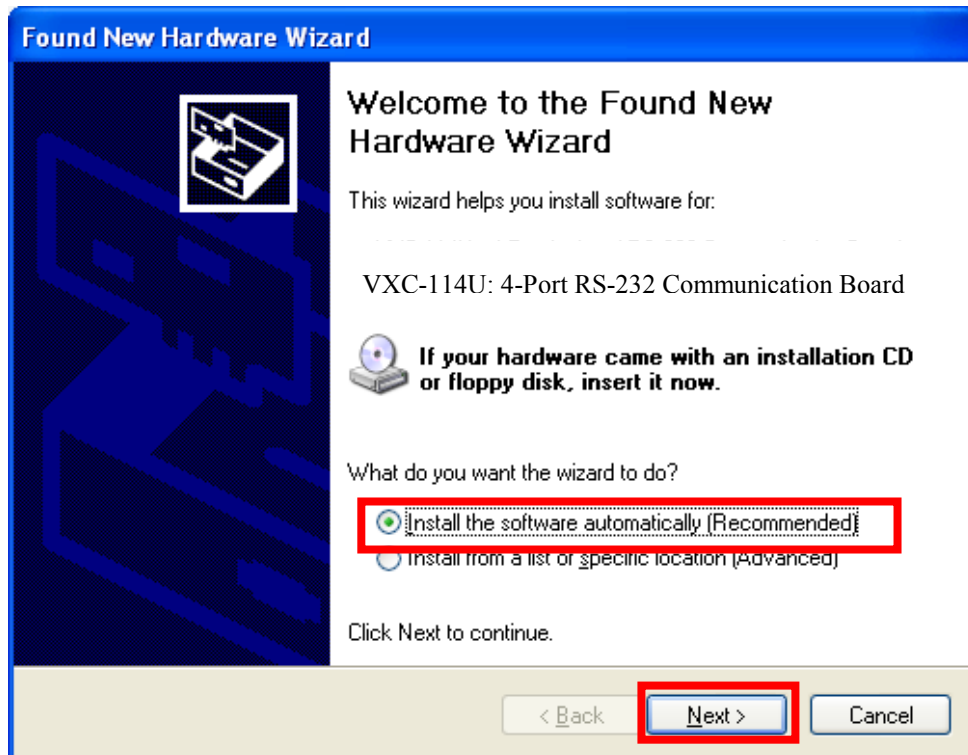

8. Click “**Finish**” button.
9. Windows pops up “**Found New Hardware Wizard**” dialog box again. Please repeat the step 8 to 9 to finish the installation for all COM ports.

3.3.3 Restore the Driver Signing Setting

1. Select "Start / Settings / Control Panel" and then "System".
2. Select the "Hardware" page on "System Properties" window and click "Driver Signing".
3. Select "**Warn – Prompt me each time to choose an action**", check "**Make this action the system default**" and then click "OK" to close the "Driver Signing Options" window.



4. Click the "**Windows Update**" button on "System Properties" window.

Note:

The "**Windows Update**" setting supports **Windows XP SP2** only. If the system is not Windows XP SP2, please skip step 4 to 6.

-
5. Select “**A**sk me to search Windows Update every time I connect a new device” and click “**OK**” button.

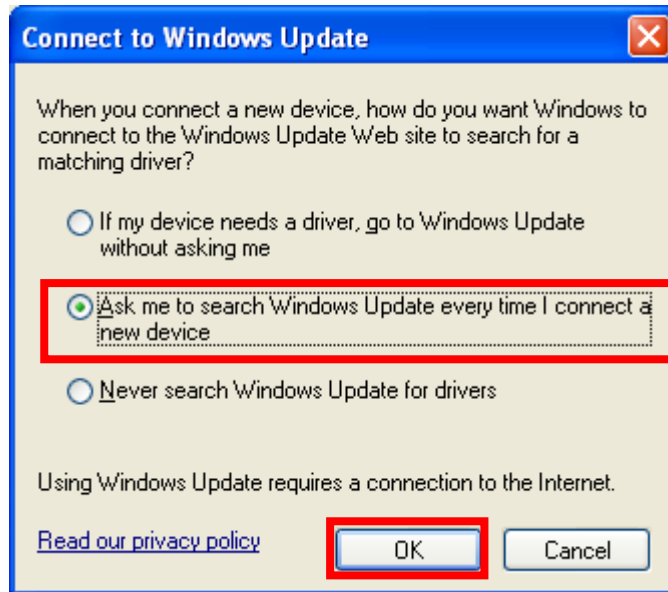

6. Click “**OK**” button to close the “**System Properties**” window.

3.3.4 Verification

To verify the installation, please complete the following steps:

1. Select “**Start / Settings / Control Panel**” and double-click the “**System**” icon.
2. Click the “**Hardware**” tab and then click the “**Device Manager**” button.

The VXC/VEX Card is listed under the “**VXC Multi-port serial Card**” class, and each Communications Port is listed under the “**Ports (VxCard – RS-232/422/485)**” class.

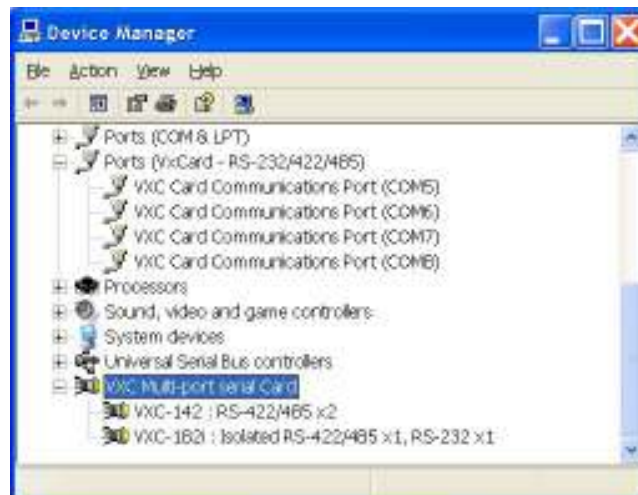

3.3.5 Configuration

If need, users can change the input buffer size (default is 4 KB for each port, up to 128 KB) by setting the “SW FIFO” scroll-bar on the VxCard Utility. The utility’s short cut is placed on the desktop after driver installed.

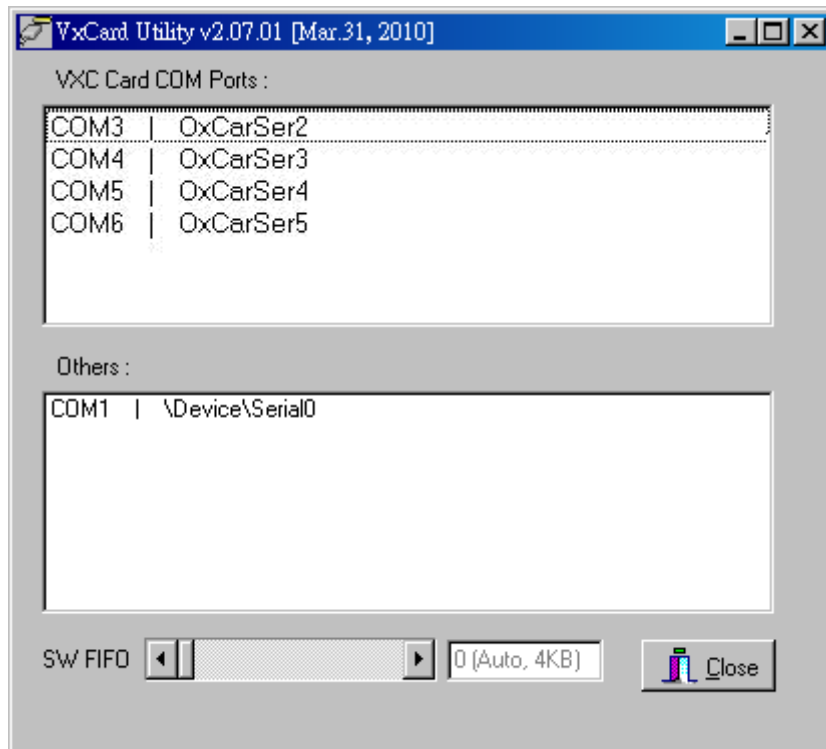

To change the COM port mappings (see **Section 2.2 COM Port Mappings and Board ID**), users should restart the driver by rebooting the computer, or re-install the “**VXC/VEX Card**” hardware in the “**Device Manager**” by un-install card and then scan new hardware.

3.3.6 Uninstallation

Before removing the card from your computer, it’s recommended to uninstall the device from the “**Device Manager**”. This removes unused hardware information from the database (registry) of Windows.

3.4 Windows Vista

3.4.1 Driver Installation

Note:

It's recommended to install the software first, and then the hardware. This reduces the configuration procedures.

Refer to "**Quick Start Guide**" for getting the location of setup program on CD.

1. Launch the **VxCard_W7_v2.08.00.exe** to install the driver and register the related information onto the system.
2. Click "**Allow, I trust this program. I know where it's from or I've used it before**" on the "**User Account Control**" window.

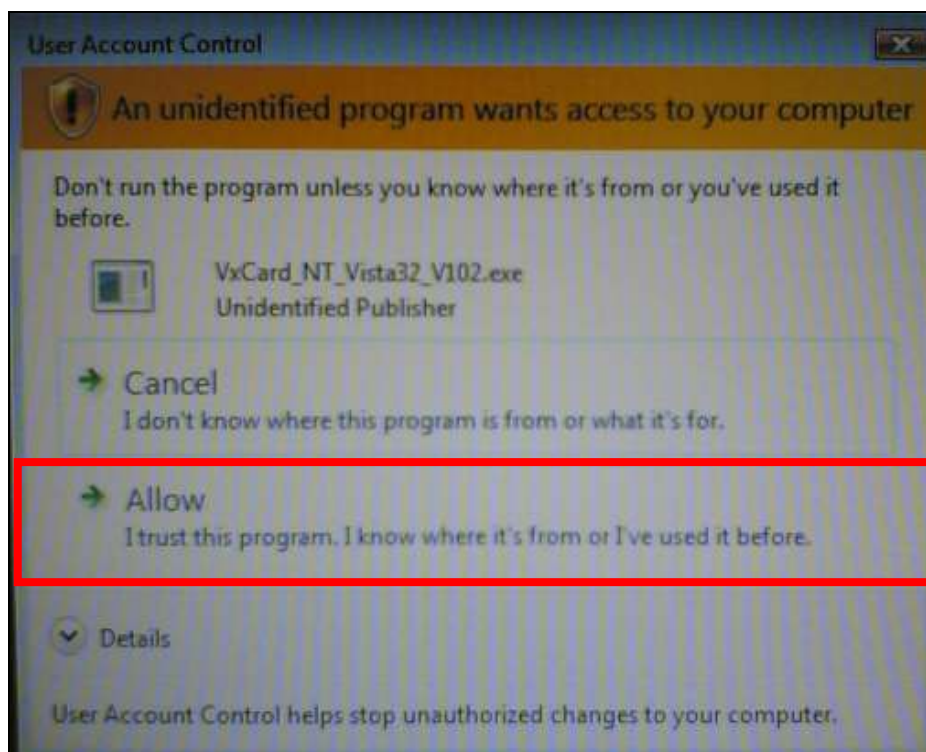

3. Click "**Next>**" button to start installation.

4. Select folder where setup will install files, and click “**Next>**” button.

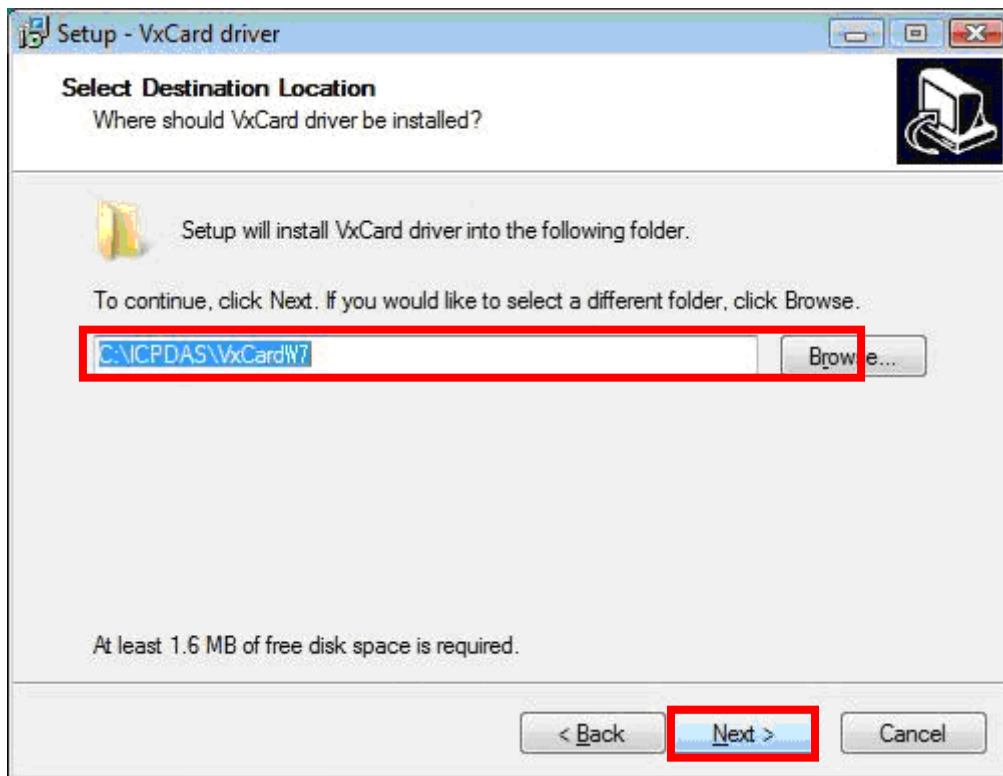

5. Click “**Install this driver software anyway**”.



Note:

The prompt will repeat for several times. Please click “**(Install this driver software anyway)**” for all these prompts.

-
6. Select **No, I will restart the computer later** and click **Finish** button.

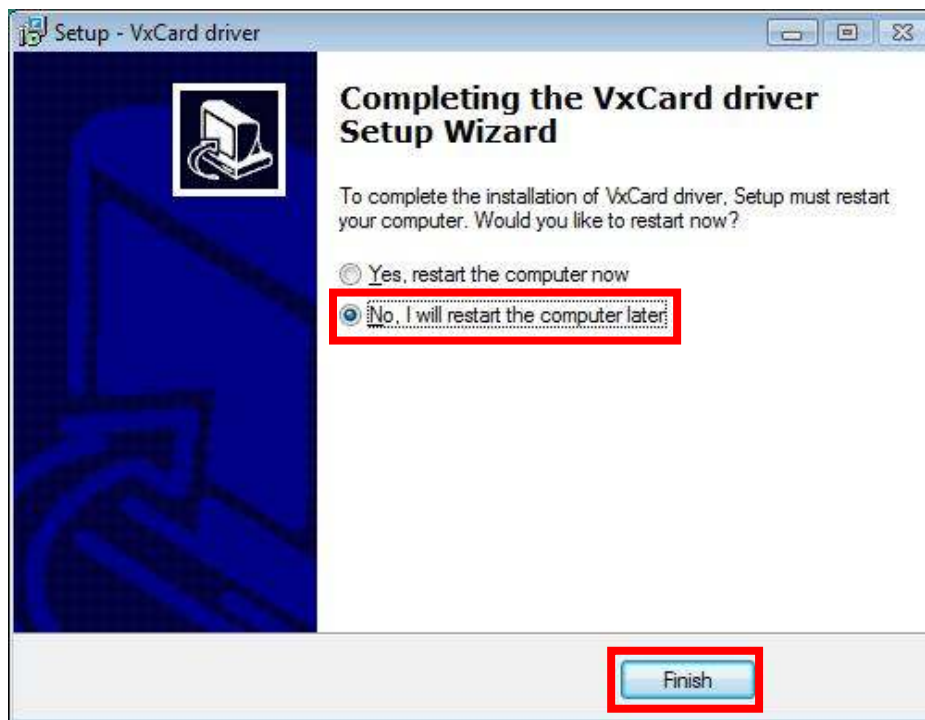

7. Turn off the computer and install the VXC/VEX card into the PC.
8. Power on the computer and system will find the new card and make it work automatically.

3.4.2 Verification

To verify the installation, please complete the following steps:

1. Select **"Start / Settings / Control Panel"** and double-click the **"System"** icon.
2. Click the **"Hardware"** tab and then click the **"Device Manager"** button.

The VXC/VEX Card is listed under the **"VXC Multi-port serial Card"** class, and each Communications Port is listed under the **"Ports (VxCard – RS-232/422/485)"** class.

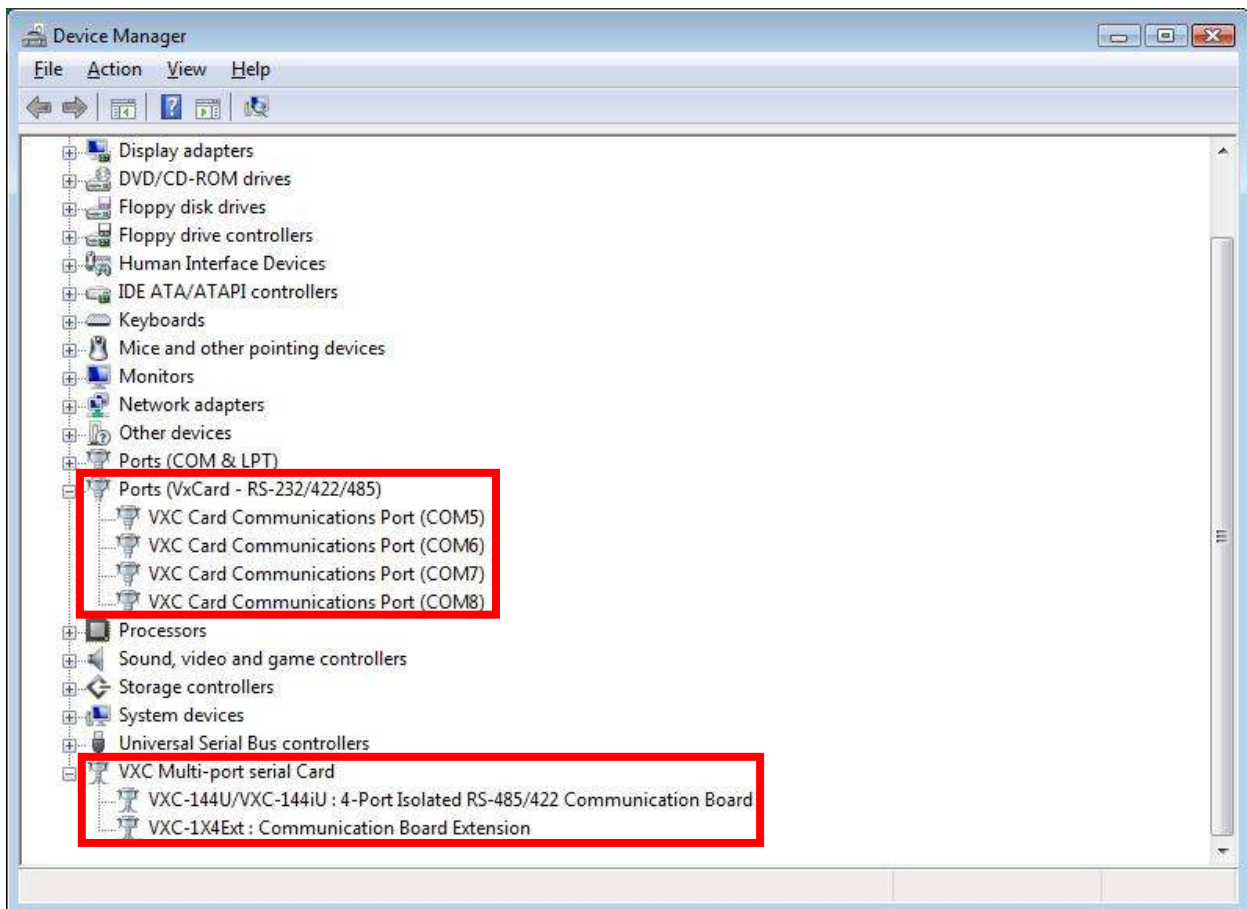

3.4.3 Configuration

If needed, users can change the input buffer size (default is 4 KB for each port, up to 128 KB) by setting the "SW FIFO" scroll-bar on the VxCard Utility. The utility's short cut is placed on the desktop after driver installed.

-
1. Click “**VxCard Utility.exe**”.
 2. The VXC/VEX Card Utility shows all COM ports that existing in the system.

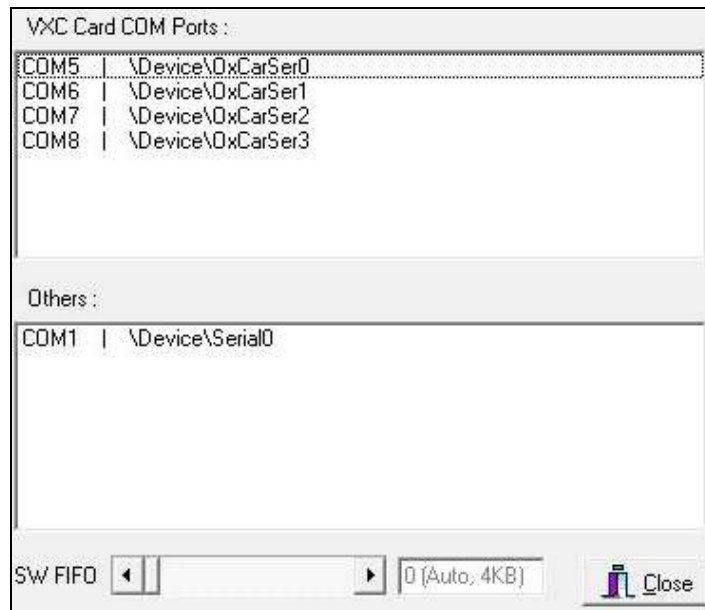

To change the COM port mappings (see **Section 2.2 COM Port Mappings and Board ID**), users should restart the driver by rebooting the computer, or re-install the “**VXC/VEX Card**” hardware in the “**Device Manager**” by un-install card and then scan new hardware.

3.4.4 Uninstallation

Before removing the card from your computer, it’s recommended to uninstall the device from the “**Device Manager**”. This removes unused hardware information from the database (registry) of Windows.

3.5 Windows 7

3.5.1 Driver Installation

Note:

It's recommended to install the software first, and then the hardware. This reduces the configuration procedures.

Refer to “**Quick Start Guide**” for getting the location of setup program on CD.

1. Launch the **VxCard_W7_v2.08.00.exe** to install the driver and register the related information onto the system.
2. Click “Yes” button.

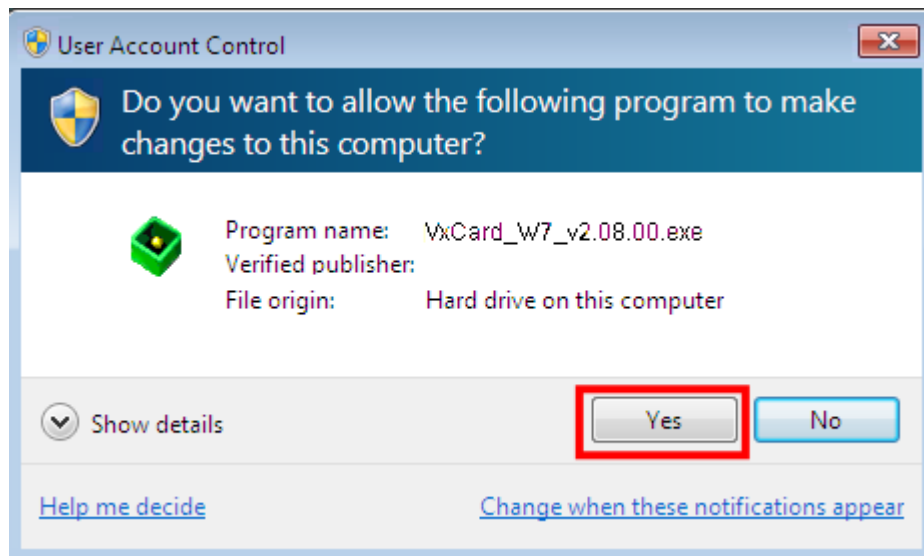

3. Click “**Next>**” button to start installation.

4. Select folder where setup will install files, and click “**Next>**” button.

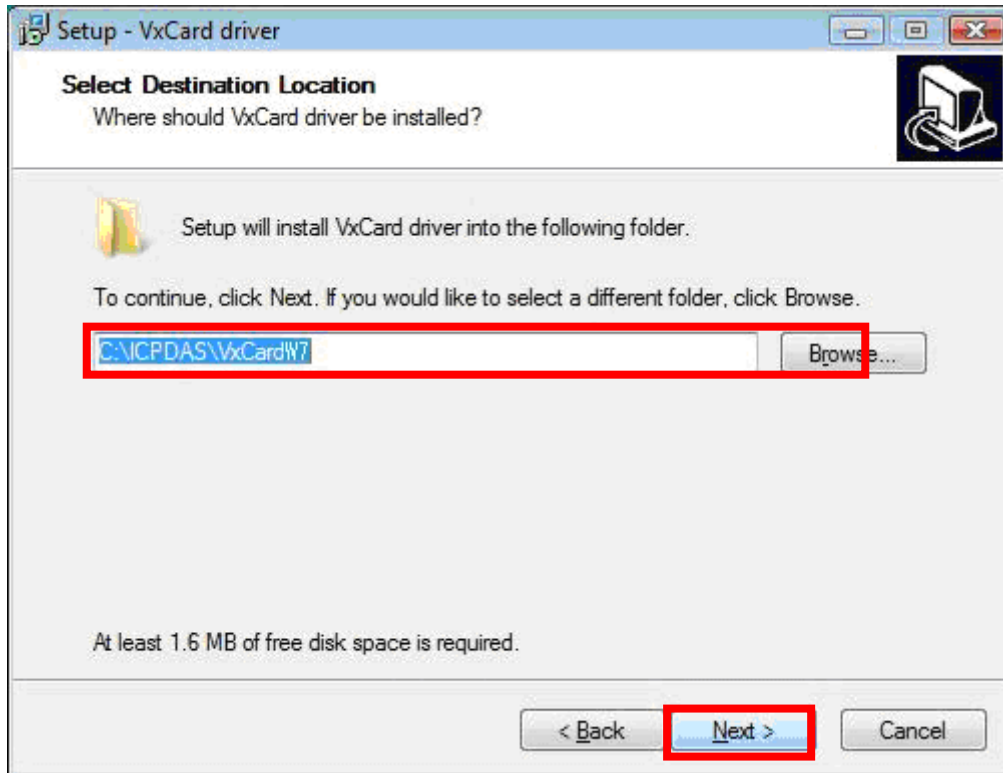

5. Click “**Install this driver software anyway**”.



Note:

The prompt will repeat for several times. Please click “**(Install this driver software anyway)**” for all these prompts.

6. Select “**No, I will restart the computer later**” and click “**Finish**” button.

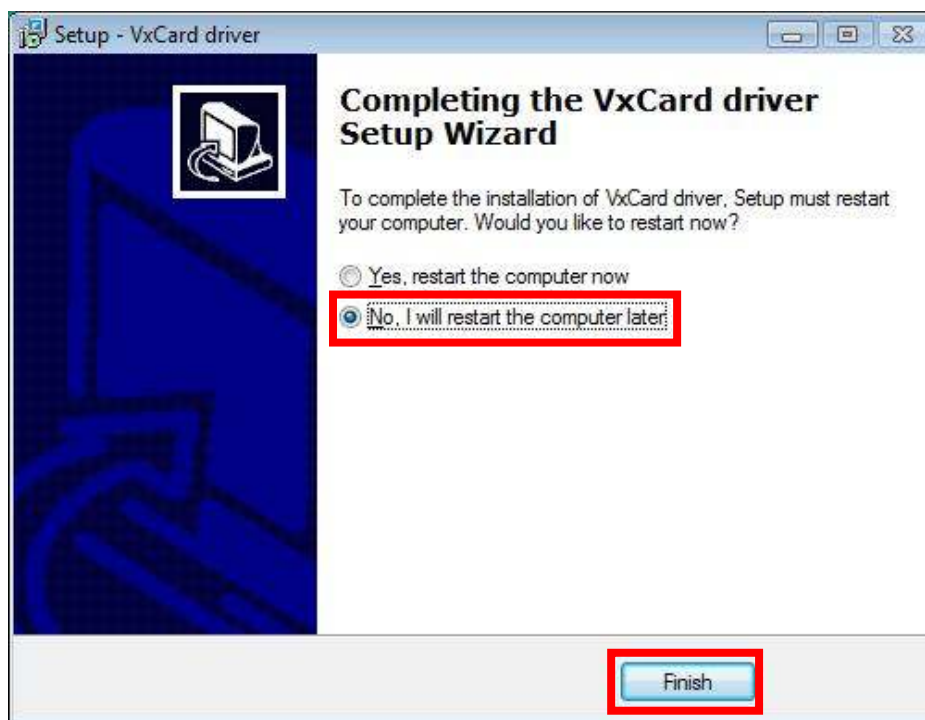

7. Turn off the computer and install the VXC/VEX card into the PC.
Power on the computer and system will find the new card and make it work automatically.

3.5.2 Verification

To verify the installation, please complete the following steps:

3. Select **"Start / Settings / Control Panel"** and double-click the **"System"** icon.
4. Click the **"Hardware"** tab and then click the **"Device Manager"** button.

The VXC/VEX Card is listed under the **"VXC Multi-port serial Card"** class, and each Communications Port is listed under the **"Ports (VxCard – RS-232/422/485)"** class.

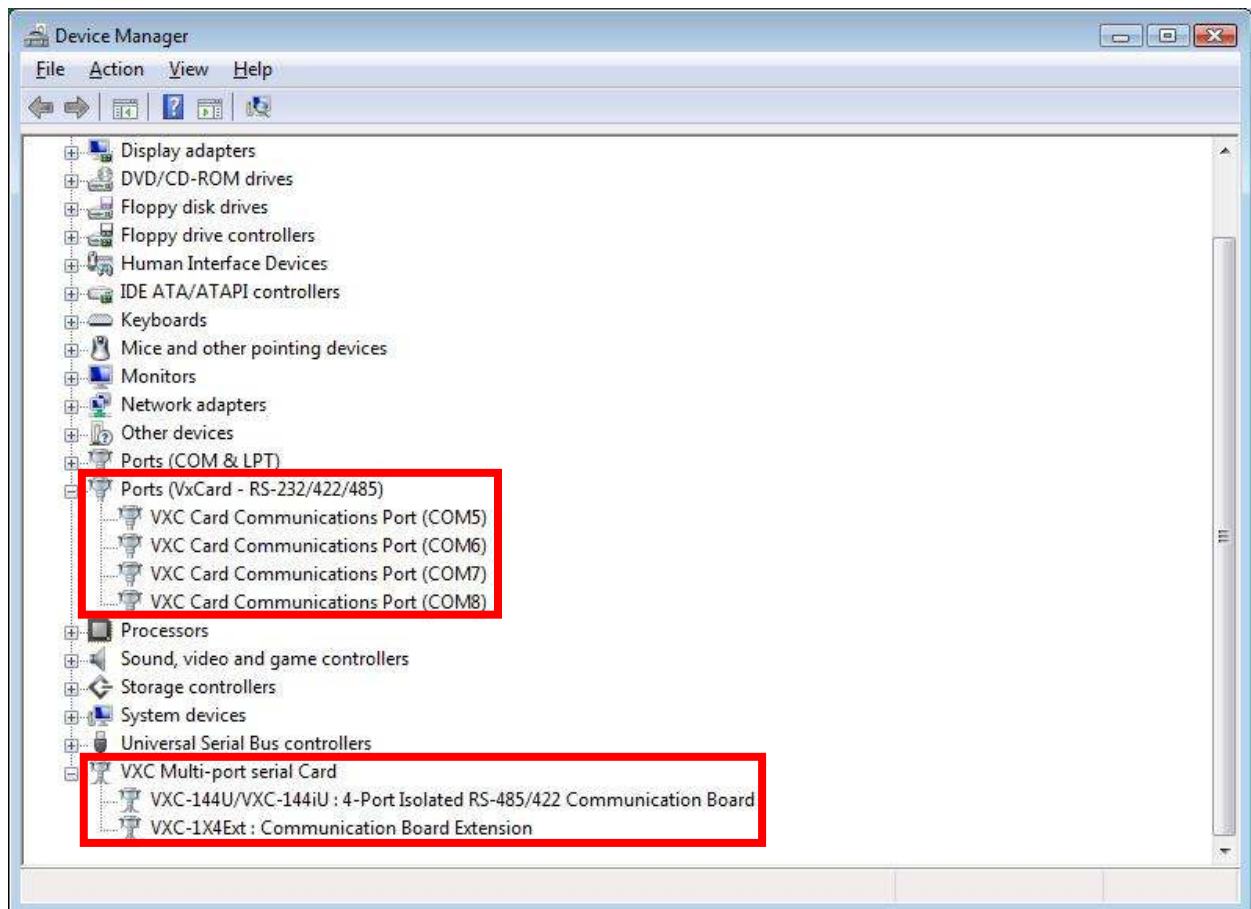

3.5.3 Configuration

If needed, users can change the input buffer size (default is 4 KB for each port, up to 128 KB) by setting the "SW FIFO" scroll-bar on the VxCard Utility. The utility's short cut is placed on the desktop or start menu after driver installed.

3. Click **“VxCard Utility.exe”**

4. The VXC/VEX Card Utility shows all COM ports that existing in the system.

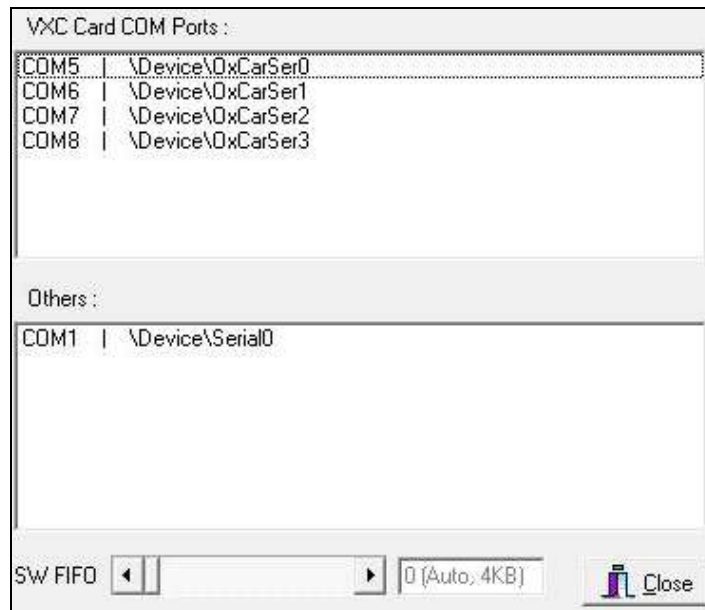

To change the COM port mappings (see **Section 2.2 COM Port Mappings and Board ID**), users should restart the driver by rebooting the computer, or re-install the **“VXC/VEX Card”** hardware in the **“Device Manager”** by un-install card and then scan new hardware.

3.5.4 Uninstallation

Before removing the card from your computer, it’s recommended to uninstall the device from the **“Device Manager”**. This removes unused hardware information from the database (registry) of Windows.

3.6 Linux

This section describes VXC/VEX Card Linux driver's features and how to compile and install into a general Linux system (Linux kernel 2.4.X or 2.6.X). The VXC/VEX Card Linux driver is modified from Linux kernel source and supports most of popular PC-based Linux distributions.

3.6.1 Driver Features

- Device file.
- Dynamic device allocation.
- Dynamic major number.
- One major number for multiple devices.
- Use the GNU configure and build system.

3.6.2 Installation

Please refer to the following steps to complete it.

1. Download or copy the **ixCOM** package to a directory that you have access to.
2. Extract the package. For example, the package's file name is "**ixcom-0.8.1.tar.gz**" and its path related to your current working directory is `../pkg`, then the extraction command would be

```
#tar -zxvf ../pkg/ixcom-0.8.1.tar.gz
```

An `ixcom-0.8.1` directory is created after extraction.

3. For convenient access, it is a good idea to put a symbol-link on it.

```
#ln -s ixcom-0.8.1 ixcom
```

4. Change to the **ixcom** working directory you just made, type

```
#!/configure to create proper Makefiles.
```

5. Once the configuring has done successfully, type “**make**” to build all.

Note: If you like to install files to system directory, the make install will do it for you. However, install files to system directory is not necessary for further operation. You will need the root privilege for that.

Script “**./ixcom.inst**” loads modules automatically. Script “**./ixcom.remove**” removes the loaded modules. The root privilege is required when installing or removing these kernel modules.

3.6.3 Access to VXC/VEX Serial Port

Script “**ixcom.inst**” will establish unused device major number dynamically and create correspond device node for access VXC/VEX serial port.

```
# ./ixcom.inst
IxCOM Installer 0.5.0
Check kernel version... 2.6
Use proc-file /proc/icpdas/ixcom
Load module ixcom
```

Use “**dmesg**” command to inspect the driver output message.

```
dmesg
.....
.....
ICPDAS VXC multi-serial card Serial driver version ixcom-0.8.1 (2007-08-21)
Found ICPDAS VXC-114U series board(BusNo=0,DevNo=20)
PCI: Found IRQ 11 for device 0000:00:14.0
PCI: Sharing IRQ 11 with 0000:00:07.2
PCI: Sharing IRQ 11 with 0000:00:14.1
ttySV0 at port cc00 (irq = 11) is a 16C950/954
ttySV1 at port d000 (irq = 11) is a 16C950/954
ttySV2 at port d400 (irq = 11) is a 16C950/954
ttySV3 at port d800 (irq = 11) is a 16C950/954
```

The script "**ixcom.inst**" had loaded module into kernel and find a VXC/VEX card that have four serial port, ttySV0, ttySV1, ttySV2 and ttySV3.

The "**ixcom.inst**" script will use major number 254 to create correspond device on the /dev.

```
# ls -la /dev/ttySV?  
crw-rw-rw- 1 root root 254, 64 Jul 14 10:13 /dev/ttySV0  
crw-rw-rw- 1 root root 254, 65 Jul 14 10:13 /dev/ttySV1  
crw-rw-rw- 1 root root 254, 66 Jul 14 10:13 /dev/ttySV2  
crw-rw-rw- 1 root root 254, 67 Jul 14 10:13 /dev/ttySV3  
crw-rw-rw- 1 root root 254, 68 Jul 14 10:13 /dev/ttySV4  
crw-rw-rw- 1 root root 254, 69 Jul 14 10:13 /dev/ttySV5  
crw-rw-rw- 1 root root 254, 70 Jul 14 10:13 /dev/ttySV6  
crw-rw-rw- 1 root root 254, 71 Jul 14 10:13 /dev/ttySV7  
crw-rw-rw- 1 root root 254, 72 Jul 14 10:13 /dev/ttySV8  
crw-rw-rw- 1 root root 254, 73 Jul 14 10:13 /dev/ttySV9
```

To remove VXC/VEX driver from system use script "**./ixcom.remove**" to removes the loaded modules.

4. Programming Reference

4.1 PCI Hardware IDs

Card	Vendor ID	Device ID	Sub-Vendor ID	Sub-Device ID	Version
VXC-114U	0x1415	0x9504	0x1441	0x0090	Rev1.1
VXC-114iAU	0x1415	0x9501	0x1441	0x0091	Rev4.0
VXC-144U	0x1415	0x9504	0x1440	0x0090	Rev3.1
VXC-144iU	0x1415	0x9501	0x1440	0x0091	Rev4.0
VXC-112(A)U	0x1415	0x9501	0x1441	0x0080	Rev1.3
VXC-112iAU	0x1415	0x9505	0x1441	0x0080	Rev4.0
VXC-142(A)U	0x1415	0x9501	0x1440	0x0080	Rev1.2
VXC-142i(A)U	0x1415	0x9505	0x1440	0x0080	Rev4.0
VXC-182i(A)U	0x1415	0x9501	0x1442	0x0080	Rev1.1
	0x1415	0x9505	0x1442	0x0080	Rev4.0
VEX-114(i)	0x1415	0xC20D	0x1441	0x0091	Rev1.0
VEX-144(i)	0x1415	0xC20D	0x1440	0x0091	Rev1.0

4.2 I/O Address Mapping

The I/O address of the VXC/VEX series card is automatically assigned by the main-board ROM BIOS. The universal version of VXC/VEX series cards using two PCI functions as followings:

Application:

VXC-112U, VXC-142U/142iU, VXC-182iU, VXC-114U/114iAU (Version after Rev1.2),
VXC-144U (Version after Rev1.2), VXC-144iU (Version after Rev3.2)

Base Address Register	Function 0	Function 1
BAR0	UARTs (I/O Mapped)	Local Bus (I/O Mapped)
BAR1	UARTs (Memory Mapped)	Local Bus (Memory Mapped)
BAR2	Local Configuration Registers (I/O Mapped)	Reserved
BAR3	Local Configuration Registers (Memory Mapped)	Reserved
BAR4	Reserved	Reserved
BAR5	Reserved	Reserved

Application:

VXC-112(A)U/112iAU (Rev4.0), VXC-142AU/142iAU (Rev4.0), VXC-182iAU (Rev4.0)

Base Address Register	Function 0	Function 1
BAR0	UART0 (I/O Mapped)	Local Bus (I/O Mapped)
BAR1	UART1 (I/O Mapped)	Local Bus (Memory Mapped)
BAR2	Reserved	Reserved
BAR3	Reserved	Reserved
BAR4	Local Configuration Registers (I/O Mapped)	Reserved
BAR5	Local Configuration Registers (Memory Mapped)	Reserved

Note: Please contact us for more information about I/O Address Mapping.

Application:

VXC-114U (Rev1.1), VXC-144U (Rev1.1), VXC-144iU (Rev3.1)

Base Address Register	Function 0	Function 1
BAR0	UART0 (I/O Mapped)	Local Bus (I/O Mapped)
BAR1	UART1 (I/O Mapped)	Local Bus (Memory Mapped)
BAR2	UART2 (I/O Mapped)	Reserved
BAR3	UART3 (I/O Mapped)	Reserved
BAR4	Local Configuration Registers (I/O Mapped)	Reserved
BAR5	Local Configuration Registers (Memory Mapped)	Reserved

Note: Please contact us for more information about I/O Address Mapping.

Application:

VEX-114(i) (Rev1.0), VEX-144(i) (Rev1.0)

Base Address Register	Function 0	Function 1
BAR0	GPIO (Memory Mapped)	UART (Memory Mapped)
BAR1	All visible Modules and MSI-X	All visible Modules and MSI-X (Used for MSI-X)
BAR2	Reserved	All visible Modules and MSI-X (Used for EEPROM)
BAR3	Reserved	Reserved
BAR4	Reserved	Reserved
BAR5	Reserved	Reserved

Note: Please contact us for more information about I/O Address Mapping.

4.3 UART Register

Register Name	Address	R/W	Bit 7	Bit 6	Bit 5	Bit 4	Bit 3	Bit 2	Bit 1	Bit 0	
THR ¹	000	W	Data to be transmitted								
RHR ¹	000	R	Data received								
IER ^{1,2} 650/950 Mode 550/750 Mode	001	R/W	CTS interrupt mask	RTS interrupt mask	Special Char. Detect	Sleep mode	Modem interrupt mask	Rx Stat interrupt mask	THRE interrupt mask	RxRDY interrupt mask	
			Unused		Alternate sleep mode						
FCR ³ 650 mode 750 mode 950 mode	010	W	RHR Trigger Level		THR Trigger Level		Tx Trigger Enable	Flush THR	Flush RHR	Enable FIFO	
			RHR Trigger Level		FIFO Size	Unused					
			Unused								
ISR ³	010	R	FIFOs enabled		Interrupt priority (Enhanced mode)		Interrupt priority (All modes)			Interrupt pending	
LCR ⁴	011	R/W	Divisor latch access	Tx break	Force parity	Odd / even parity	Parity enable	Number of stop bits	Data length		
MCR ^{3,4} 550/750 Mode 650/950 Mode	100	R/W	Unused		CTS & RTS Flow Control	Enable Internal Loop Back	OUT2 (Int En)	OUT1	RTS	DTR	
			Baud prescale	IrDA mode	XON-Any						
LSR ^{3,5} Normal 9-bit data mode	101	R	Data Error	Tx Empty	THR Empty	Rx Break	Framing Error	Parity Error	Overrun Error	RxRDY	
							9 th Rx data bit				
MSR ³	110	R	DCD	RI	DSR	CTS	Delta DCD	Trailing RI edge	Delta DSR	Delta CTS	
SPR ³ Normal 9-bit data mode	111	R/W	Temporary data storage register and Indexed control register offset value bits								
			Unused								9 th Tx data bit
Additional Standard Registers – These registers require divisor latch access bit (LCR[7]) to be set to 1.											
DLL	000	R/W	Divisor latch bits [7:0] (Least significant byte)								
DLM	001	R/W	Divisor latch bits [15:8] (Most significant byte)								

4.4 Programmable Baud Rate

Baud Rates Using a 14.7456 MHz Crystal (Universal series cards)

DESIRED BAUD RATE	DIVISOR USED TO GENERATE 16× CLOCK	PERCENT (%) ERROR
50	18432	
75	12288	
110	8376	0.026
150	6144	
300	3072	
600	1536	
1200	768	
2400	384	
4800	192	
9600	96	
14400	64	
19200	48	
23040	40	
28800	32	
38400	24	
56000	16	2.86
57600	16	
115200	8	
184320	5	
230400	4	
307200	3	
460800	2	

Warning: The baud rates higher than 115,200 bps are not guaranteed to work.

Baud Rates Using a 62.5 MHz Crystal (PCI Express series cards)

DESIRED BAUD RATE	TCR Reg	CPR Bit(7:3)	DLM	DLL	PERCENT (%) ERROR
1200	0100	00100	0C	B6	0.037
2400	0100	00100	06	5B	0.037
4800	0100	00100	03	2D	0.099
9600	0100	00100	01	96	0.221
19200	0100	00100	00	CB	0.221
38400	0100	00100	00	66	-0.270
57600	0100	00100	00	44	-0.270
115200	0100	00100	00	22	-0.270
230400	0100	00100	00	11	-0.270
460800	0100	00001	00	22	-0.270
921600	0100	00001	00	11	-0.270
1843200	0100	00100	00	02	-0.270
3686400	0100	00100	00	01	-0.270

Warning: The baud rates higher than 115,200 bps are not guaranteed to work.

4.5. Customized Baud Rate

To generate baud rate 125,000 bps:

$$125,000 * 16 * 8 = 16,000,000 = 16 \text{ MHz crystal}$$

So, when you use a 16 MHz crystal to replace the built-in 14.7 MHz crystal (for U versions VXC cards) and select the baud rate 115,200 bps in your software setting, the hardware will generate baud rate 125 kbps actually.

Note: External 14.7 MHz crystal can be customized to replace (for U versions VXC cards), but VEX cards (PCI Express) can't.

To generate baud rate 250,000 bps:

$$250,000 * 16 * 4 = 16,000,000 = 16 \text{ MHz crystal}$$

$$(\text{Baud rate} * 16 * \text{clock} * \text{Divisor} = \text{Crystal Clock Frequency})$$

Thus, when you use a 16 MHz crystal to replace the built-in 14.7 MHz crystal (for U versions VXC cards) and select the baud rate 230,400 bps in your software setting, the hardware will generate baud rate 250 kbps actually.

Note: The multi-port serial cards can have a special baud rate in OEM version. Please contact us for more information regarding the OEM products.

Warning: The baud rates higher than 115,200 bps are not guaranteed to work.